

Use & Care Guide  
Manual de Uso y Cuidado  
English / Español

Model / Modelo: 790.4114\*

# Kenmore PRO<sup>®</sup>

## Double Wall Oven

## Horno de pared four encastré

\* = color number, número de color

P/N A00538401 Rev. D

Sears Brands Management Corporation  
Hoffman Estates, IL 60179 U.S.A.  
[www.kenmore.com](http://www.kenmore.com)

Sears Canada Inc.  
Toronto (Ontario) Canada M5B 2C3  
[www.sears.ca](http://www.sears.ca)



# Table of Contents

Before Setting Oven Controls .....	7	Care and Cleaning .....	23
Setting Oven Controls.....	9	Before You Call .....	27
		Solutions to Common Problems .....	28

---

## Please carefully read and save these instructions

This Use and Care Manual contains general operating instructions for your appliance and feature information for several models. Your product may not have all the described features. The graphics shown are representative. The graphics on your appliance may not look exactly like those shown. Common sense and caution must be practiced when installing, operating and maintaining any appliance.

## KENMORE PRO LIMITED WARRANTY

FOR ONE YEAR from the date of sale this appliance is warranted against defects in material or workmanship when it is correctly installed, operated and maintained according to all supplied instructions.

WITH PROOF OF SALE, a defective appliance will receive free repair or replacement at option of seller.

For warranty coverage details to obtain free repair or replacement, visit the web page: [www.kenmore.com/warranty](http://www.kenmore.com/warranty)

This warranty applies for only **90 DAYS** from the sale date in the United States, and is void in Canada, if this appliance is ever used for other than private household purposes.

### This warranty covers **ONLY** defects in material and workmanship, and will **NOT** pay for:

1. Cracks in a ceramic glass cooktop that are not a result of thermal shock.
2. Stains and scratches on a ceramic glass cooktop resulting from accident or improper operation or maintenance.
3. Discoloration of cooktop surfaces resulting from normal use.
4. Expendable items that can wear out from normal use, including but not limited to filters, belts, bags or screw-in base light bulbs.
5. A service technician to clean or maintain this appliance, or to instruct the user in correct appliance installation, operation and maintenance.
6. Service calls to correct appliance installation not performed by Sears authorized service agents, or to repair problems with house fuses, circuit breakers, house wiring, and plumbing or gas supply systems resulting from such installation.
7. Damage to or failure of this appliance resulting from installation not performed by Sears authorized service agents, including installation that was not in accord with electrical, gas or plumbing codes.
8. Damage to or failure of this appliance, including discoloration or surface rust, if it is not correctly operated and maintained according to all supplied instructions.
9. Damage to or failure of this appliance, including discoloration or surface rust, resulting from accident, alteration, abuse, misuse or use for other than its intended purpose.
10. Damage to or failure of this appliance, including discoloration or surface rust, caused by the use of detergents, cleaners, chemicals or utensils other than those recommended in all instructions supplied with the product.
11. Damage to or failure of parts or systems resulting from unauthorized modifications made to this appliance.
12. Service to an appliance if the model and serial plate is missing, altered, or cannot easily be determined to have the appropriate certification logo.

## Disclaimer of implied warranties; limitation of remedies

Customer's sole and exclusive remedy under this limited warranty shall be product repair or replacement as provided herein. Implied warranties, including warranties of merchantability or fitness for a particular purpose, are limited to one year or the shortest period allowed by law. Seller shall not be liable for incidental or consequential damages. Some states and provinces do not allow the exclusion or limitation of incidental or consequential damages, or limitation on the duration of implied warranties of merchantability or fitness, so these exclusions or limitations may not apply to you.

This warranty applies only while this appliance is used in the United States or Canada\*.

This warranty gives you specific legal rights, and you may also have other rights which vary from state to state.

\* In-home repair service is not available in all Canadian geographical areas, nor will this warranty cover user or servicer travel and transportation expenses if this product is located in a remote area (as defined by Sears Canada Inc.) where an authorized servicer is not available.

**Sears Brands Management Corporation, Hoffman Estates, IL 60179**

**Sears Canada Inc., Toronto, Ontario, Canada M5B 2C3**



# IMPORTANT SAFETY INSTRUCTIONS

Read all instructions before using this appliance.

This manual contains important safety symbols and instructions. Pay attention to these symbols and follow all instructions given.

Do not attempt to install or operate your appliance until you have read the safety precautions in this manual. Safety items throughout this manual are labeled with a WARNING or CAUTION statement based on the hazard type.

## DEFINITIONS

**⚠** This is the safety alert symbol. It is used to alert you to potential personal injury hazards. Obey all safety messages that follow this symbol to avoid possible injury or death.

**⚠ WARNING** - Indicates a potentially hazardous situation which, if not avoided, may result in death or serious injury.

**⚠ CAUTION** - Indicates a potentially hazardous situation which, if not avoided, may result in minor or moderate injury.

**Important:** Indicates installation, operation, maintenance, or valuable information that is not hazard related.

**⚠ WARNING** Storage in or on appliance—Flammable materials should not be stored in an oven or near surface units. This includes paper, plastic, and cloth items, such as cookbooks, plastic ware, and towels, as well as flammable liquids. Do not store explosives, such as aerosol cans, on or near the oven.

**⚠ WARNING** Do not leave children alone - Children should not be left alone or unattended in the area where appliance is in use. They should never be allowed to sit or stand on any part of the appliance, including the storage drawer, lower broiler drawer, warmer drawer, or lower double oven.

## **⚠ WARNING** Tip Over Hazard



- A child or adult can tip the oven and be killed.
- Install the anti-tip device to oven and/or structure per installation instructions.

- Ensure the anti-tip device is re-engaged when the oven is moved.
- Do not operate the oven without the anti-tip device in place and engaged.
- Failure to follow these instructions can result in death or serious burns to children and adults.

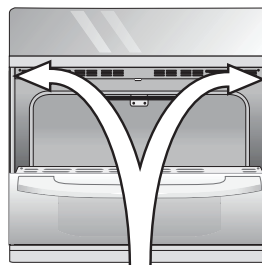

Anti-tip mounting holes

Refer to the installation instructions supplied with your appliance for proper installation.

Check for proper installation with a visual check that the anti-tip screws are present.

Test the installation with light downward pressure on the open oven door. The oven should not tip forward.

**⚠ WARNING** Stepping, leaning, or sitting on the door or drawers of an oven can result in serious injuries and also cause damage to the appliance. Do not store items of interest to children near or above the appliance or let children climb or play around the oven. The weight of a child on an open oven door may cause the oven to tip, resulting in serious burns or other injury.

**⚠ WARNING** Never cover any slots, holes, or passages in the oven bottom or cover an entire oven rack with materials, such as aluminum foil. Aluminum foil linings may trap heat, causing a fire hazard.

Save these instructions for future reference.

# IMPORTANT SAFETY INSTRUCTIONS

Read all instructions before using this appliance.

**⚠ CAUTION** Wear proper apparel. Loose-fitting or hanging garments should never be worn while using this appliance. Do not let clothing or other flammable materials come into contact with hot surfaces.

**⚠ CAUTION** Do not heat unopened food containers. Build-up of pressure may cause container to burst and result in injury.

**⚠ CAUTION** When heating fat or grease, watch it closely. Grease may catch fire if it becomes too hot.

**⚠ CAUTION** Do not use water or flour on grease fires. Smother fire or flame or use dry chemical or foam-type extinguisher. Cover the fire with a pan lid or use baking soda.

**⚠ CAUTION** Use dry potholders. Moist or damp potholders on hot surfaces may result in burns from steam. Do not let potholders touch hot cooking areas. Do not use towels or other bulky cloths.

**Important: Important Safety Notice** - The California Safe Drinking Water and Toxic Enforcement Act requires the governor of California to publish a list of substances known to cause cancer, birth defects, or other reproductive harms, and it requires businesses to warn customers of potential exposures to such substances.

**⚠ CAUTION** Read and follow the below instructions and precautions for unpacking, installing, and servicing your appliance:

- Remove all tape and packaging before using the oven. Destroy the carton and plastic bags after unpacking the oven. Never allow children to play with packaging material.
- Remove the oven door from any unused oven if it is to be stored or discarded.
- Be sure to have an appropriate foam-type fire extinguisher available, visible, and easily located near the appliance.

- Proper installation—Be sure your appliance is properly installed and grounded by a qualified technician in accordance with the National Electrical Code ANSI/NFPA No. 70 latest edition and local electrical code requirements. In Canada, install in accordance with CSA Standard C22.1, Canadian Electrical code, Part 1, and local electrical code requirements. Install only per installation instructions provided in the literature package for this oven.
- User servicing—Do not repair or replace any part of the appliance unless specifically recommended in the manuals. All other servicing should be done only by a qualified technician. This reduces the risk of personal injury and damage to the oven.
- Ask your dealer to recommend a qualified technician and an authorized repair service. Know how to disconnect the power to the oven at the circuit breaker or fuse box in case of an emergency.
- Never modify or alter the construction of an oven by removing the leveling legs, panels, wire covers, anti-tip brackets/screws, or any other part of the oven.
- Do not attempt to operate the oven during a power failure. If the power fails, always turn off the oven. If the oven is not turned off and the power resumes, the oven will begin to operate again. Once the power resumes, reset the clock and oven function.
- Cold temperatures can damage the electronic control. When using this appliance for the first time, or when the appliance has not been used for an extended period of time, be sure the appliance has been in temperatures above 32°F (0°C) for at least 3 hours before turning on the power to the appliance.

Save these instructions for future reference.

# IMPORTANT SAFETY INSTRUCTIONS

Read all instructions before using this appliance.

## IMPORTANT INSTRUCTIONS FOR USING YOUR OVEN

- Never use your appliance for warming or heating the room.
- Use care when opening oven door, lower oven door, or warmer drawer (some models). Stand to the side of the oven when opening the door of a hot oven. Let hot air or steam escape before you remove or replace food in the oven.
- Do not touch heating elements or interior surfaces of the oven.
- Keep oven vent ducts unobstructed. Touching surfaces in this area when the oven is on may cause severe burns. Do not place plastic or heat-sensitive items on or near the oven vent. These items can melt or ignite.
- Placement of oven racks - Always place oven racks in desired location while oven is cool. If rack must be moved while oven is hot, do not let potholder contact hot heating element in oven. Use potholders and grasp the rack with both hands to reposition. Remove all bakeware and utensils before moving the rack.
- Do not use a broiler pan without its insert. Broiler pans and inserts allow dripping fat to drain away from the high heat of the broiler. Do not cover the broiler insert with aluminum foil; exposed fat and grease could ignite.
- Protective liners - Do not use aluminum foil or any other materials to line surface unit drip bowls or oven bottoms, except as suggested in the manual. Improper installation of these liners may result in a risk of electric shock, or fire.
- Do not cook food on the oven bottom. Always cook in proper bakeware and always use the oven racks.

## IMPORTANT INSTRUCTIONS FOR CLEANING YOUR OVEN

**⚠ CAUTION** Before manually cleaning any part of the oven, be sure all controls are turned off and the oven is cool. Cleaning a hot oven can cause burns.

Clean the oven regularly to keep all parts free of grease that could catch fire. Do not allow grease to accumulate.

Always follow the manufacturer's recommended directions for use of kitchen cleaners and aerosols. Be aware that excess residue from cleaners and aerosols may ignite causing damage and injury.

Do not touch heating elements or oven interior until oven is completely cooled.

## SELF CLEANING OVENS (some models)

- Clean only the parts listed in this manual. Before using self clean, remove the broiler pan, any food, utensils, and bakeware from the oven. Remove oven racks unless otherwise instructed.
- Do not use oven cleaners. No commercial oven cleaner or oven liner protective coating of any kind should be used in or around any part of the oven.
- Do not clean door gasket. The door gasket is essential for a good seal. Care should be taken not to rub, damage, or move the gasket.
- Some birds are extremely sensitive to the fumes given off during the self clean cycle of any oven. Move birds to another well-ventilated room.

Save these instructions for future reference.

# IMPORTANT SAFETY INSTRUCTIONS

Read all instructions before using this appliance.

## GROUNDING INSTRUCTIONS

**⚠ WARNING** Avoid fire hazard or electrical shock. Failure to follow this warning may cause serious injury, fire, or death.

This appliance must be supplied with the proper voltage and frequency, and connected to an individual, properly grounded branch circuit, protected by a circuit breaker or fuse.

It is the responsibility and obligation of the consumer to contact a qualified installer to assure that the electrical installation is adequate and is in conformance with all local codes and ordinances.

See the installation instructions packaged with this appliance for complete installation and grounding instructions.

## Product Registration and Customer Information

### Serial Plate Location

The serial plate is located as shown below:

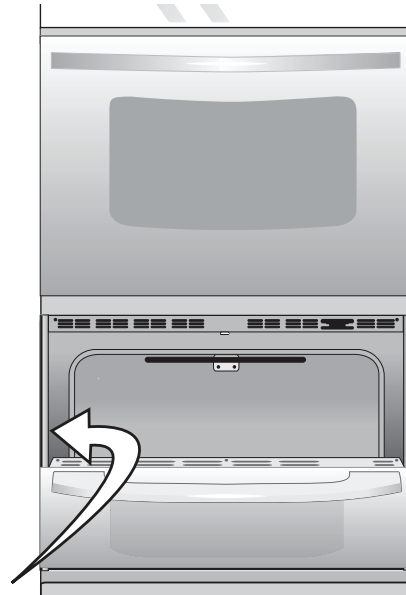

Record the date of purchase, model and serial number of your product in the corresponding space below.

Model Number: \_\_\_\_\_

Serial Number: \_\_\_\_\_

Date of Purchase: \_\_\_\_\_

Save your sales receipt for future reference.

Save these instructions for future reference.

# Before Setting Oven Controls

## Oven Vent Location

The oven vent is located as shown in [Figure 1](#). When the oven is on, warm air passes through this vent. This venting is necessary for proper air circulation in the oven and good baking results. Do not block oven vent. Steam or moisture may appear near the oven vent. This is normal.

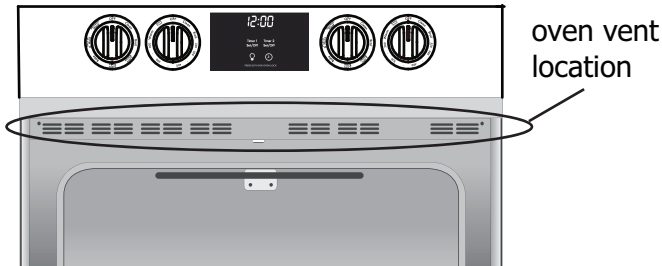

Figure 1: Oven vent location

**CAUTION** Always use pot holders or oven mitts when using the oven. When cooking, the oven interior and exterior, oven racks and cooktop will become very hot which can cause burns.

**WARNING** Protective liners — Do not use aluminum foil to line the oven bottom. Only use aluminum foil as recommended in this manual. Improper installation of these liners may result in risk of electric shock, or fire

**CAUTION** Do not line the oven walls, racks, bottom, or any other parts of the oven with aluminum foil. Doing so will alter heat distribution, produce poor baking results, and may cause permanent damage to the oven interior. During self clean temperatures the oven will be hot enough to melt foil.

**Important note:** This model comes with lubricated porcelain oven racks which can remain in the oven during the self-clean cycle. Do not clean this vegetable lubrication off the racks. It is important that the sides of the oven racks always have a light coating of vegetable oil. To maintain optimal rack performance, re-apply a thin layer of vegetable oil to the sides of the rack after every self-clean cycle or when the rack becomes difficult to slide.

## Types of Oven Racks

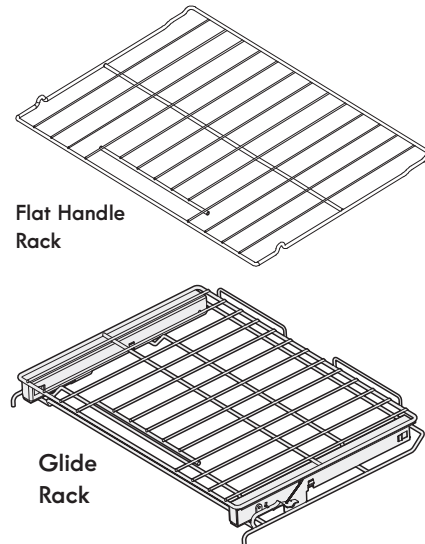

Figure 2: Rack Types

- The flat handle oven rack may be used for most cooking needs.
- The glide rack allows the user to check on food away from the oven without having to remove the cookware.

## Arranging, Removing, and Replacing Racks

**Important:** To remove glide rack, follow instructions on the next page.

**To arrange** - Always arrange the oven racks when the oven is cool.

**To remove** - Pull the rack forward until it stops. Lift up front of rack and slide out.

**To replace** - Fit oven rack onto the rack guides on both sides of oven walls. Tilt the front of oven rack upward and slide the rack back into place. Be sure oven racks are level before using.

## Before Setting Oven Controls

### Removing and Replacing Glide Racks

The fully extendable glide rack makes food preparation easier. This oven rack has glide tracks that allow the rack to be pulled away from the oven without rubbing the sides of the oven wall. When checking on food simply pull the rack towards you. The glide rack is designed to allow you to extend food away from the oven.

#### To remove the glide rack from the oven:

**To remove** - Using one hand, reach through handle opening and lift up on the release lever located across the lower front of the rack as shown in figure 3.

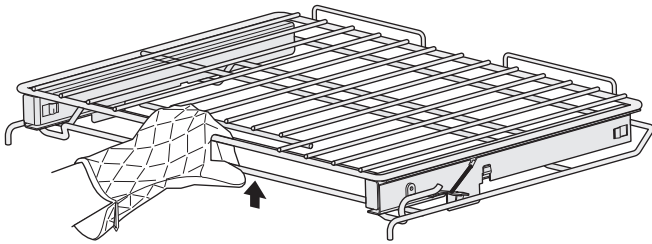

Figure 3: Grasp handle and lift up on bar

While holding up the release lever, pull the glide rack out of the oven until the stop position is reached

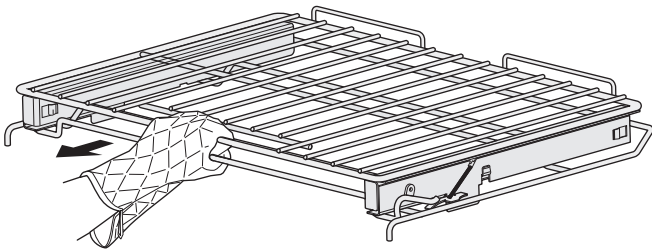

Figure 4: Pull rack to stop position

Using both hands, grasp the upper and lower portions of the glide rack. Lift up the front of the rack slightly and continue to pull the rack away from the oven.

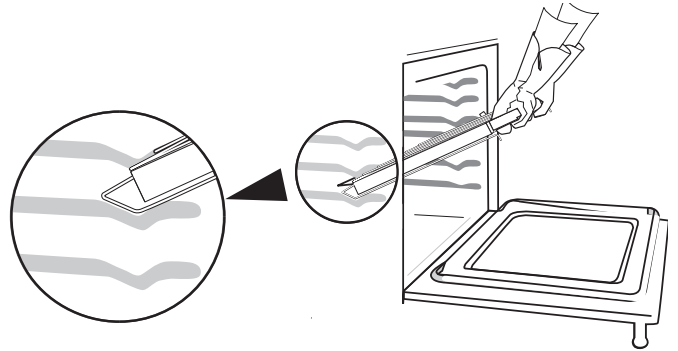

Figure 5: Remove and replace using both hands

Be sure to grasp both upper and lower rack portions together when removing or handling the glide rack. The rack portions move independently and are difficult to handle unless held together.

**To replace** - grasp both upper and lower portions of glide rack, lift and hold the rack level between the oven cavity walls. Tilt the front of the rack upward slightly and slide the rack completely into position.

To see how to properly maintain your porcelain glide racks see ["Caring for the glide racks"](#) in the Care and Cleaning section on [page 26](#).

**Important note:** To prevent possible damage to the oven, do not attempt to close the oven door until all the oven racks are fully positioned back inside the oven cavity.

# Setting Oven Controls



## OVEN MODE SETTINGS

**AccelaHeat™** - Use AccelaHeat for single rack items only and place food in center of oven before setting temperature.

**Bake** - Use to select bake function before setting temperature.

**Clean** - Use to select clean feature cycle before setting clean with oven temperature selector.

**Conv Bake** - Use to select convection baking before setting oven temperature.

**Conv Roast** - Use to select convection roast for beef, lamb, pork, and poultry before setting oven temperature.

**Broil** - Use to set broil feature before setting broil with oven temperature selector.

**Warm & Hold** - Keeps cooked foods at serving temperature for up to 3 hours.

**Bread Proof** - Provides low temperature perfect for proofing bread.

## OVEN DISPLAY FEATURES

- Oven light** - Use to turn on the internal oven light.
- Clock** - Use to set the time of day.
- TIMER** - Use to set or cancel the minute timer. The minute timer does not start or stop any cooking function.

**OVEN TEMP SETTINGS** - Use to set oven temperatures between 170°F (KEEP WARM) and 550°F. The Clean setting should only be used after reading all cautions and warnings in “Clean” on [page 21](#).

## Oven Minimum and Maximum Control Settings

Feature	Min. Temp/Time	Max. Temp/Time
BAKE	200°F (93°C)	550°F (288°C)
AccelaHeat	200°F (93°C)	550°F (288°C)
CONV BAKE	200°F (93°C)	550°F (288°C)
CONV ROAST	200°F (93°C)	550°F (288°C)
MEAT PROBE	140°F (60°C)	210°F (99°C)
BROIL	550°F (288°C)	
BREAD PROOF	100°F	110°F
WARM & HOLD	170°F	3 HR
CLEAN	2 HR	4 HR
TIMER	0:01 Hr	11:59
CLOCK (12hr)	1:00 Hr	12:59 Hr

## User Preference Settings

The default (factory) settings include **Aud** (audible control setting), **ES** (energy saving), **UPO** (User Programmable Offset) for changing the oven temperature, and **def** (default) with **rSt** (reset).





User preferences are accessed by holding the light key for 3 seconds while the oven is in the idle mode and no timers are active. Once activated, the user can make changes and scroll through the menu of options described above. Specific instructions on how to set the available user preferences can be found throughout this Oven Control section.

## Setting Oven Controls

### Setting the Clock

The clock icon is used to access the time of day setting. When the oven is first plugged in or if there has been an interruption in power to the oven, **12:00** will flash in the display.

#### To set the correct time of day:

1. Press the clock icon.
2. The display will show a time along with a  and a  key in the display below.
3. Press either  or  key to scroll to the correct time of day and release the key.
4. The control will accept the new set time with a chime, and the control will show the time of day along with the two timers that are available.

**Important:** The clock cannot be changed when the oven is set for cooking or self clean is active. Only a 12 hour clock is available on the Kenmore Professional model.

### Setting Continuous Bake or 12 Hour Energy Saving

The oven is preset to cook up to 12 hours and to shut off automatically. For longer periods of cooking, this feature can be changed to continuous cooking by setting the user preference and turning the energy saving feature off.

#### To set the oven for continuous cooking:





1. Press and hold the **light** key for 3 seconds until the display sounds an acceptance chime and shows one of the user preferences.
2. Press the  or  key until **ES** appears and **ON** is showing.



Figure 6: Energy saving with ON and OFF options

3. To turn the energy saving feature off, press the  or  key until **OFF** appears in the display.
4. The control will accept the change in a few seconds and sound the acceptance chime. The oven is now set for continuous cooking.
5. To return to the time of day display, press and hold the **light** key for 3 seconds until the display chimes and fades back to showing the time of day in the display.

### Setting the Timer

The minute timers in the oven display serve as extra timers to help keep track of cooking functions. The timer cannot be used during a self clean cycle or if the meat probe function associated with the timer display is in use. The minimum timer setting is 1 minute and the maximum setting is 11:59 (HR:MIN).

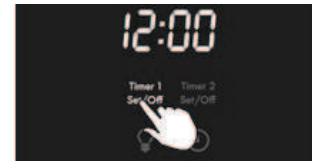

Figure 7: Press Timer Set/Off before setting time and again to stop timer

#### To set the timer:





1. Press either **TIMER Set/Off** key.
2. The timer display will show **0:00** and the  and  keys. NOTE: If the  key is pressed at this time an invalid key chime will sound.
3. Press the  key to begin to scroll to the desired setting. If the key is held, the timer value will increase rapidly. Once the desired setting is reached, press the timer key and the timer will start counting down automatically in a few seconds.



Figure 8: Setting the timer

4. The timer display will show the **H:M** icon if the timer is set for more than 1 minute. If the value is under 1 minute, the timer will display the time in seconds and the **H:M** icon will not appear.
5. When the timer ends, a reminder chime will sound and repeat once every 60 seconds for a period of five minutes. Before the user can program an expired timer again, the timer key must be pressed.
6. To cancel the timer before the set time expires, press the **TIMER Set/Off** key.

The minute timers will not start or stop the cooking process. The minute timers can be used alone or while using most of the other oven features.

## Setting Control for Silent Operation

The oven is set to operate with certain chimes and tones (default settings) that alert the user to certain oven functions. The silent operation feature allows the oven control to be operated without sounds when necessary. By accessing user preferences, this option can be later returned to operate with normal programming sounds.

### To set the oven control for silent operation:

1. Press and hold  for a few seconds until the display sounds an acceptance chime. **AUd** should appear in the display.

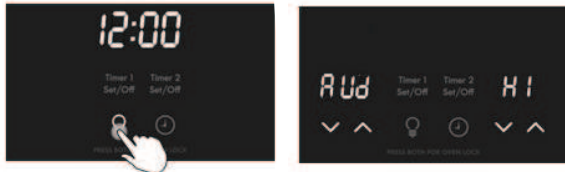



2. If **AUd** is not showing, press the  key until **AUd** appears and **HI** is showing in the display. This is the normal (default) setting.



Figure 9: Default setting for oven control sounds

3. To turn the audible feature to a lower sound or completely **OFF**, press the  or  key until **LO** or **OFF** appears in the display.



4. When the desired setting appears in the display, release the key and wait for an acceptance chime.
5. To return to the time of day display, press and hold  key for 3 seconds until the display chimes and fades back to showing the time of day.

## Oven Light

The oven lights in both ovens will turn on automatically when an oven door is opened. The oven lights may be turned on when the door is closed by using the oven light key located on the control panel.

**Note:** Keep oven light off while baking. The oven light will turn off during a clean cycle and not operate.

### To toggle the oven lights on and off:

1. Press oven light symbol .

The interior oven lights are covered with glass shields. The glass shields must be in place whenever the oven is in use.

To change the interior oven lights, see [“Replacing the Oven Lights”](#) in the Care & Cleaning section.

## Setting Oven Lock

When the Oven Lock is set, both oven doors are locked along with the oven control and oven functions. If the user tries to set the oven mode or temperature mode the control with signal an invalid key tone (triple beep).

### To set Oven Lock:

1. Press and hold both the light key and clock key for about 3 seconds.
2. The control will beep and the motor door latch will begin to close. Do not try to open the oven doors while the mechanism is locking.



Figure 10: Press and hold light key and clock key

3. Once locked, a lock icon and **LOC** will appear in the display.

### To unlock the oven doors:

1. Press and hold both the light key and clock key for about 3 seconds. **LOC** will flash and the motor door locks will begin unlocking the doors. Do not attempt to open the oven doors while unlocking.
2. When the lock icon and **LOC** goes away, the doors can be opened and the oven controls will be available.

## Setting Oven Controls

### AccelaHeat™

Use the AccelaHeat feature whenever you wish to start baking immediately, without the need for preheating. This feature provides good results when preparing convenience foods, such as cinnamon rolls, frozen pizza, bacon, french fries, and tater tots. Food will finish baking in the time stated in the cooking directions without the additional time ordinarily required for preheating.

**Important:** For batter and dough-based baked goods such as cakes, pastries, and breads, use the convection function for best results.

During AccelaHeat, the fan will pulse on and off, and the bake element will cycle on and off to maintain the set temperature for precise baking.

AccelaHeat may be set for any oven temperature between 200°F (93°C) to 550°F (288°C).

#### AccelaHeat best practices:

- Always place the food in the oven on rack position 3. AccelaHeat is designed for baking on a single oven rack, placed in the center of the oven.
- When using AccelaHeat, use bakeware with low or no sides. This allows the air to circulate around the food evenly.
- Food that comes in strips, such as fish sticks and chicken tenders, should be placed on the pan with the ends pointing to the sides of the oven.
- Follow the package directions for food preparation time and temperature. AccelaHeat works best when cooking foods longer than 10 minutes. If directions call for a shorter cooking time, a few extra minutes may be required for optimal cooking results.
- Do not open the oven door often. Opening the door will reduce the temperature in the oven and may increase bake time.

#### To set AccelaHeat:

**CAUTION** Always use pot holders or oven mitts when using the oven. When cooking, the oven interior and oven racks, will become very hot which can cause burns.

1. Remove food from packaging and arrange on baking pan.
2. Place pan in oven on rack position 3 (Figure 11) and close oven door. AccelaHeat is designed for baking on a single oven rack placed in the center of the oven.
3. Turn the oven mode selector to the AccelaHeat position.
4. Turn the oven temperature selector to the desired temperature. Baking will begin immediately.
5. To stop baking turn the oven mode selector to OFF. Also return the oven temperature selector to the OFF position.

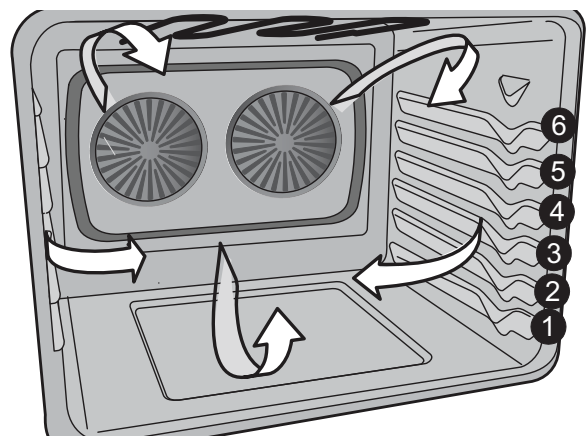

Figure 11: Rack positions

## Setting Bake

Use the **Bake** function whenever a recipe calls for baking using normal temperatures. For batter and dough-based baked goods such as cakes, pastries, and breads, use the convection function for best results.

### Baking tips

#### For best bake results:

- Fully preheat the oven before baking items like cookies, cakes, biscuits, and breads. When using any single rack, position the rack so that the food is in the center of the oven.
- Leave oven light off while baking.
- Convection baking is preferred for multiple rack baking.
- For best results when baking cakes using two oven racks, place Glide rack in position 4 with the flat handle rack in position 1. (See [Figure 12](#)).
- When using two oven racks, position cookware as shown in [Figure 13](#) with pans on top rack near front and lower rack pans in the middle of the rack. Allow at least 2-4 inches (5-10 cm) of space between cookware for proper air circulation.
- Cookies should be baked on a pan with low or no sides for best results. When using two racks for baking cookies, place the Glide rack in position 5 and flat rack in position 3.
- Dark or dull bakeware absorbs more heat than shiny bakeware. It may be necessary to reduce oven temperature and cook time to prevent overbrowning of some foods. Dark bakeware is recommended for pies. Shiny bakeware is recommended for cakes, cookies, and muffins.

Bake may be set for any temperature between 200°F (93°C) and 550°F (288°C).

#### To set a bake for 350°F:

1. Be sure to arrange racks to the desired positions for the item(s) to be baked.
2. Turn the oven mode selector to the **Bake** position.
3. Turn the oven temperature selector to **350°F**.
4. The **PREHEAT** message and the oven temperature light will turn on and the control will sound an acceptance tone. The oven will begin heating.
5. When the set temperature is reached the **PREHEAT** message will turn off and a reminder chime will sound alerting you to place food in oven. Set either timer to keep track of actual cooking time if necessary.
6. When finished baking, be sure to return both the temperature selector knob and the oven mode knob to the **OFF** positions.

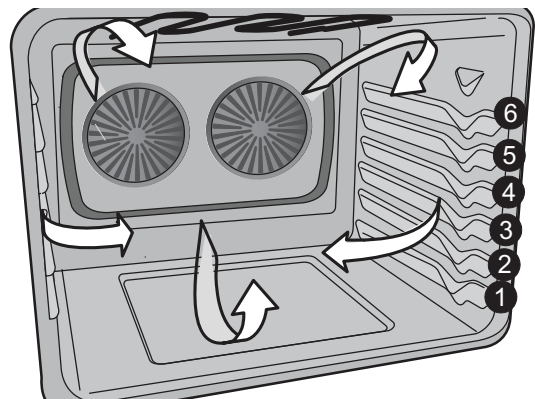

Figure 12: Rack positions

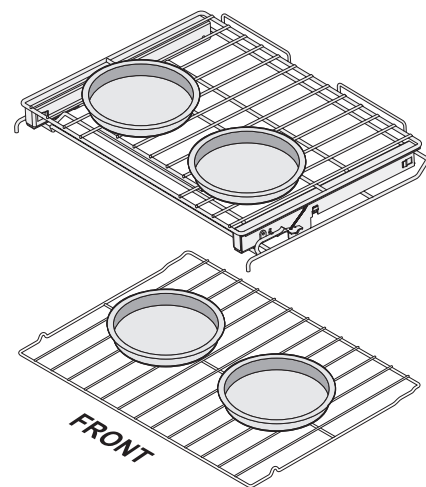

Figure 13: Cookware positioned for two rack baking

**Important:** Do not open the oven door often. Doing so will reduce the temperature in the oven and may increase the cooking time necessary for best results.

## Setting Oven Controls

### Convection Baking

Convection Baking enables you to obtain the best results when baking with multiple pans and racks. The oven can be programmed for convection baking at any temperature between 200°F to 550°F. The convection function uses a fan to circulate the oven heat uniformly and continuously around the oven (Figure 14). This improved heat distribution allows for fast, even cooking and browning results. It also gives better baking results when using two oven racks at the same time.

#### Benefits of convection cooking:

- Multiple rack baking.
- Some foods may cook faster, saving time and energy.

#### Convection baking tips:

- Because most food items will cook faster and more evenly with the convection feature, it is advisable to reduce recipe's recommended temperature by 25° for best results. Follow the recipe's instructions using the minimum recommended cook time.
- Fully preheat the oven before baking items like cookies, cakes, biscuits, and breads.
- For single rack baking, position the rack so that food is in the center of the oven.
- For best results when baking cakes using two oven racks, place Glide rack in position 4 with the flat handle rack in position 1. (See Figure 14).
- When baking using two oven racks, position cookware as shown in Figure 15 with pans on top rack near front and lower rack pans in the middle of the rack. Allow at least 2 inches (5 cm) of space between cookware for proper air circulation.
- Cookies should be baked on a pan with low or no sides for best results. When using two racks for baking cookies, place the Glide rack in position 5 and flat rack in position 3.
- Dark or dull bakeware absorbs more heat than shiny bakeware. It may be necessary to reduce oven temperature and cook time to prevent overbrowning of some foods. Dark bakeware is recommended for pies. Shiny bakeware is recommended for cakes, cookies, and muffins.
- Do not open oven door too often. Doing so reduces oven temperature and may extend cooking time.
- Cookies and biscuits should be baked on pans with no sides or very low sides to allow heated air to circulate around the food.

### Setting Convection Bake

To set the oven for convection bake and temperature to 375°F:

1. Arrange interior oven racks.
2. Turn the oven mode selector to **CONV BAKE**.
3. Turn the oven temperature selector to **375°F**.
6. The oven temperature light will blink for a few seconds before confirming the setting. The convection fan will turn on and the oven will begin heating.
7. Once the oven reaches the set temperature the oven will sound a chime indicating the food items can be placed in the oven.
8. When finished baking, be sure to return both the temperature selector knob and the oven mode knob to the **OFF** positions.

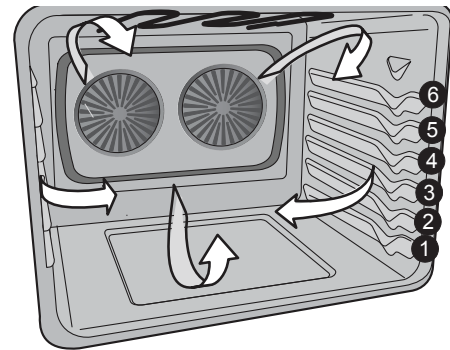

Figure 14: Convection air flow and rack positions

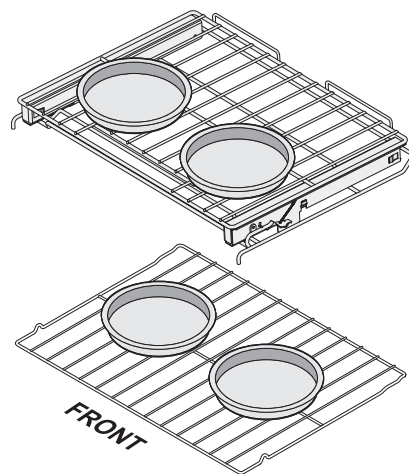

Figure 15: Suggested pan spacing

### Setting Convection Roast

Convection roast is best for cooking tender cuts of beef, lamb, pork, and poultry. Convection roasting gently browns the exterior and seals in the juices by using the bake element, convection element, broil element, and fan to circulate the heat evenly and continuously within the oven.

#### Convection roasting tips:

- Use a broiler pan and grid, as well as a roasting rack (available by mail order). The broiler pan will catch grease drippings, and the grid will help prevent spatters. The roasting rack will hold the meat. Make sure the roasting rack is securely seated on the grid in the broiler pan. Do not use the broiler pan without the grid.
- Position food (fat side up) on the roasting rack.
- Do not cover insert with aluminum foil.
- Do not open the oven door often. Doing so will reduce the temperature in the oven and may increase the cooking time necessary for best results.

**⚠ WARNING** Should an oven fire occur, do not open oven door, turn off the oven. If the fire continues, throw baking soda on the fire or use a fire extinguisher. Do not put water or flour on the fire. Flour may be explosive, and water can cause a grease fire to spread and cause personal injury.

**Important note:** If using the meat probe for convection roasting follow instructions starting on [page 17](#).

#### To set oven for convection roasting:

1. Place meat on roasting rack and place in oven.
2. Turn oven mode selector to **Conv Roast**.
3. Turn oven temperature selector to desired roasting temperature.
4. To turn off convection roast when cooking is done or any time, turn both the temperature selector and the oven mode selector to **OFF**.

**Note:** Preheating the oven for convection roasting is not necessary. At this time you may want to set a timer as a reminder for checking food.

**Table 1: Convection roasting temperature and time recommendations**

Meat		Weight	Oven Temp	Internal Temp	Minutes per lb.
Beef	Standing rib roast*	4 to 6 lb.	350°F (177°C)	*160°F (71°C)	25-30
	Rib eye roast*	4 to 6 lb.	350°F (177°C)	*160°F (71°C)	25-30
	Tenderloin roast	2 to 3 lb.	400°F (204°C)	*160°F (71°C)	15-25
Poultry	Turkey whole**	12 to 16 lb.	325°F (163°C)	180°F (82°C)	8-10
	Turkey whole**	16 to 20 lb.	325°F (163°C)	180°F (82°C)	10-15
	Turkey whole**	20 to 24 lb.	325°F (163°C)	180°F (82°C)	12-16
	Chicken	3 to 4 lb.	350°F-375°F (177°C-191°C)	180°F (82°C)	12-16
Pork	Ham roast, fresh	4 to 6 lb.	325°F (163°C)	160°F (71°C)	30-40
	Shoulder blade roast	4 to 6 lb.	325°F (163°C)	160°F (71°C)	20-30
	Loin	3 to 4 lb.	325°F (163°C)	160°F (71°C)	20-25
	Pre-cooked ham	5 to 7 lb.	325°F (163°C)	160°F (71°C)	30-40

\* The U.S. Department of Agriculture states, "Rare fresh beef is popular, but you should know that cooking it to only 140°F (60°C) means some food poisoning organisms may survive." (Source: Safe Food Book, Your Kitchen Guide, USDA Rev. June 1985.) The lowest temperature recommended by the USDA is 145°F (63°C) for medium rare fresh beef. For well done 170°F (77°C) \*\* Stuffed turkey requires additional roasting time. Shield legs and breast with foil to prevent over browning and drying of the skin.

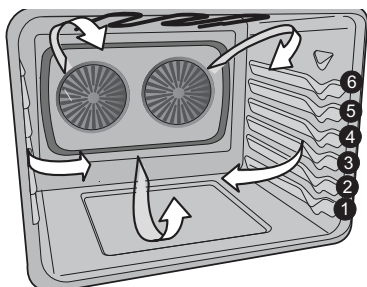

**Figure 16: Convection roasting rack positions**

**⚠ CAUTION** Do not use the broiler pan without the insert. Do not cover the broil pan or insert with aluminum foil; the exposed grease could ignite.

**Important:** When roasting chicken use the flat handle rack in rack position 2 for best results.

## Setting Oven Controls

### Using the Broil Feature

Use the broil feature to cook meats requiring direct exposure to radiant heat for optimum browning results. Broiling is direct heat cooking and can produce smoke. If smoke is excessive, place food further away from the broil element. Always watch food carefully to prevent burning. Always arrange oven racks when the oven is cool. The door must be closed for broil to operate. If the door is left open the display will show "d-O". Close the door for the function to resume. When broiling, always pull the oven rack out to the stop position before turning or removing food.

**CAUTION** Always use pot holders or oven mitts when working with a hot oven. When broiling, the oven interior, oven racks and cooktop will become hot enough to cause burns. Do not use the broiler pan without the insert. The insert is slotted and allows the grease to drain away from the meat and the high heat of the broiler into the broiler pan. Do not cover the broil pan or insert with aluminum foil; the exposed grease could ignite.

**WARNING** If an oven fire occurs, close the oven door. If the fire continues, throw baking soda on the fire or use a fire extinguisher. Do not put water or flour on the fire. Flour can be explosive; water can cause a grease fire to spread possibly causing personal injury. To prevent grease splattering, use the broil pan and insert when broiling

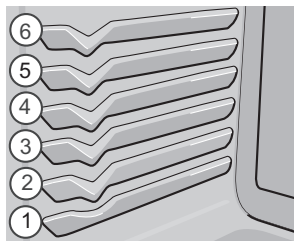

Figure 17: Rack positions

Table 2: Broiling Suggestions

Food	Rack Position	Temperature	Cook time (minutes)		Internal Temperature	Doneness
			1st side	2nd side		
Steak 1" thick	5th or 6th*	550F (288°C)	5	4	145°F (63°C)	Medium*
Steak 1" thick	5th or 6th*	550F (288°C)	8	7	160°F (71°C)	Medium-Well
Steak 1" thick	5th or 6th*	550F (288°C)	8	7	170°F (77°C)	Well
Pork Chops 3/4" thick	5th	550F (288°C)	8	6	170°F (77°C)	Well
Chicken bone-in	4th	550F (288°C)	20	10	170°F (77°C)	Well
Chicken boneless	4th	550F (288°C)	8	6	170°F (77°C)	Well
Fish	4th	550F (288°C)	13	n/a	170°F (77°C)	Well
Shrimp	4th	550F (288°C)	5	n/a	170°F (77°C)	Well
Hamburger 1" thick	6th*	550F (288°C)	5	4	135°F (57°C)	Rare**
Hamburger 1" thick	6th*	550F (288°C)	9	7	145°F (63°C)	Medium-rare
Hamburger 1" thick	6th*	550F (288°C)	10	8	170°F (77°C)	Well

\*Use flat handle rack in top position. The U.S. Department of Agriculture states, "\*\*Rare and medium-rare fresh beef is popular, but you should know that cooking it to only 140°F (60°C) means some food poisoning organisms may survive." (Source: Safe Food Book, Your Kitchen Guide, USDA Rev. June 1985.) The lowest temperature recommended by the USDA is 145°F (63°C) for medium rare fresh beef. For well done 170°F (77°C). All cook times shown are after 2 minutes of preheating.

### To set broil:

1. Arrange oven racks while oven is cool.
2. Turn the oven mode selector knob to **broil**. The indicator light will flash.
3. Turn the temperature selector knob to **broil**. The indicator light will turn on and remain lit. For optimum browning results, preheat oven for 2 minutes before adding food.
4. Place the broiler pan on the rack. Be sure to center the broiler pan directly under the broiler element.
5. Broil with the door closed.
6. Turn the temperature and the selector knobs to **OFF** when broiling is complete or to cancel broil.

### Recommended Broiling Times

Depending on the type, the thickness, and the desired doneness of meat, it might be necessary to increase or decrease suggested broiling times or adjust the broiling pan to different rack positions.

If a broiler pan and insert are not supplied with this appliance, they may be purchased from Sears.

In the U.S.A. call 1-844-4-553-6667 (in Canada 1-800-469-4663) and order broiler pan kit 5304442087.

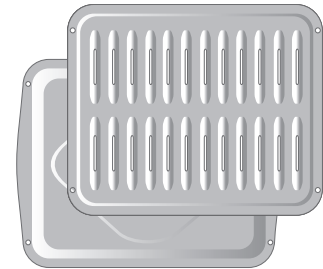

Broiler Pan and Insert

## Meat Probe

Use the probe feature for best results when cooking foods such as roasts, hams or poultry, using a probe to check internal temperature is the safest method to ensure properly cooked food. Before using the meat probe read the important information listed here:

### Important:

- The probe feature must be set before setting the cooking mode and oven temperature.
- If a timer is running when the meat probe is plugged in, the control will sound a triple beep once and the timer will keep running. The timer must be canceled before the probe temperature can be set.
- If the meat probe is unplugged during cooking function the oven will stop cooking and turn off.
- When the meat probe is set correctly, the control will signal an alert when the internal food temperature reaches the desired set target temperature. When active, the internal food temperature is visible in the display during the cooking process. This eliminates any guesswork or the need to open the oven door to check the thermometer.

### Proper placement of probe in food.

- Insert the probe so that the probe tip rests inside the center of the thickest part of meat or food. For best results, do not allow the probe to contact bone, fat, gristle, or the cookware. For bone-in ham or lamb, insert the probe into the center of lowest large muscle or joint.
- For meatloaf or casseroles, insert the probe into center of food. When cooking fish, insert meat probe just above the gill.
- For whole poultry or turkey, fully insert the probe into the thickest part of the breast.

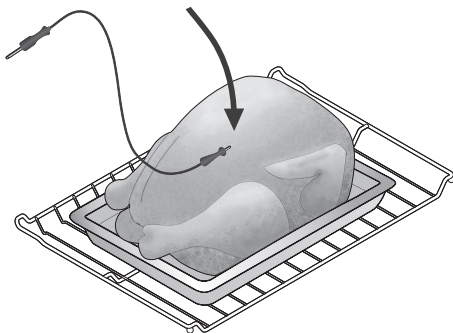

Figure 18: Proper probe placement for poultry

### To set probe:

1. Insert the probe into the food. Place prepared food on the desired oven rack position and slide into the oven.
2. Plug the connector end of the probe into the probe receptacle while the oven is still cool. The receptacle is located on the upper left front oven cavity wall.

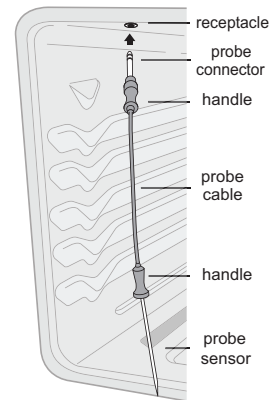





Figure 19: Meat probe components

3. When the probe is inserted, an acceptance tone will sound. Close the oven door.
4. The default temperature of 170°F appears in the display. Press the  key or  to set the desired probe temperature between 140°F and 210°F. Once desired temperature is set, the display will sound an acceptance chime.

**Note:** The probe must be fully set before setting the oven mode and temperature mode.

5. Set the **oven mode** to **Accela Heat, Bake, Conv Bake, or Conv Roast**.
6. Set the **oven temp** control to the desired cooking temperature. The oven will begin heating.
7. An up arrow  and current meat probe temperature will appear in the display until the meat probe target temperature is reached. If the meat probe temperature exceeds the maximum allowable temperature, the oven control will beep and **HOT** will appear in the display for 40 seconds to alert that the probe temperature is too high.
8. When the internal temperature of the food is within 10° of the set temperature, the control will chime and a **CHECK FOOD** reminder will appear in the display and will remain in the display and continue to chime every 60 seconds for five minutes or until the oven door is open.

## Setting Oven Controls

### Meat Probe (cont'd)

9. Once the target temperature of the food is reached, the control will chime to signal the end of cooking. At this time the  will turn off and the display will show the **FOOD READY** and **Hld** messages and the control will signal and end of cycle tone every 60 seconds until the door is opened or five minutes elapses.
10. The display will continue to show the set meat probe temperature until either **Hld** ends or the meat probe is disconnected from the receptacle.

### Easy Probe

Easy Probe allows the user to monitor the temperature of the meat while a cooking function is actively running. This feature does not cancel the cooking function when the meat probe temperature is reached. In order to activate the easy probe feature, simply insert the meat probe while an active cooking function is running. The probe temperature will immediately be shown on the display.

### Warm & Hold

Warm & Hold is perfect for keeping cooked foods at serving temperature (170°F) for up to 3 hours. To use Warm & Hold alone without any other cooking mode, both the Warm & Hold and Warm settings must be activated.

#### Warm & Hold tips:

- Always start with hot food. Do not use the keep warm feature to heat cold food.
- Food in heat-safe glass and glass ceramic containers may need higher temperature settings compared to food in regular containers. Avoid repeated openings of the oven, it will allow hot air to escape and the food to cool.
- Aluminum foil may be used to cover food to increase moisture content.

#### To set Warm & Hold:

1. Turn the oven mode control to **Warm & Hold**.
2. Turn the oven temperature control to **Warm**. The display will show **Hld** and the oven will warm to 170°F and remain at that temperature for up to 3 hours unless canceled.
3. To cancel Warm & Hold, turn both the oven mode and oven temperature controls to **OFF**.

### Setting Warm

The **Warm** setting on the oven temperature control knob is pre-set to maintain a temperature of 170°F (77°C) for up to 12 hours or until canceled. For best quality, it is recommended for food to be held in Warm for up to 3 hours. The feature may be used with **Bake**, **Conv Bake**, or **Conv Roast**.

#### To set Warm:

1. Arrange interior oven racks and place food in oven.
2. Turn the oven mode selector to **Bake**, **Conv Bake**, or **Conv Roast**.
3. Set the oven temperature selector to **Warm**. The indicator light will blink and then an acceptance chime will sound.
4. The preheat indicator light will turn on and stay on until the oven reaches 170°F.
5. To cancel **Warm**, turn the oven mode and oven temperature controls to **OFF**.

 **WARNING** Food Poisoning Hazard. Do not let food sit for more than one hour before or after cooking. Doing so can result in food poisoning or sickness.

### Bread Proof

The Bread Proof feature is pre-set to warm the oven to 100°F.

#### To turn on the Bread Proof feature:

1. Turn the oven temperature control to **Bread Proof**.
2. Turn the oven temperature mode to **Warm & Hold**, **Bake**, **Conv Bake**, or **Conv Roast**.
3. The display will show **PRF**. The control will accept the setting and **PRF** will change to show **100°F** after preheating.
4. To turn off the Bread Proof feature turn the oven temperature control and oven mode control to **OFF**.

## Setting the Sabbath Feature



This appliance provides special settings for use when observing the Jewish Sabbath/Holidays. For further assistance, guidelines for proper usage, and a complete list of models with the Sabbath feature, please visit the web at [www.star-k.org](http://www.star-k.org).

**Important:** The Sabbath feature may only be used with the Bake function.

- The Sabbath mode disables all audible tones or visual display changes on the oven control. However the control will allow any sounds associated with alarms. The oven light remains off in Sabbath mode.
- Once the oven is properly set using Bake with the Sabbath feature active, the oven will remain on until canceled.
- The meat probe feature is not available in Sabbath mode.
- If a non-Bake function is active when trying to set the Sabbath mode, the control will sound an invalid key tone (triple beep) and ignore the request to enter Sabbath mode.
- If Sabbath mode is activated in one oven and other is off, the idle oven will remain inactive as long as the active oven is in Sabbath mode.
- If using both ovens for the Sabbath, both ovens must be set to Bake before activating the Sabbath mode.
- When both ovens are set for Sabbath mode, canceling one oven will not cancel the Bake function in the other oven.

**⚠ WARNING** Food Poisoning Hazard. Do not let food sit for more than one hour before or after cooking. Doing so can result in food poisoning or sickness.

### To set the oven for baking and activate the Sabbath feature:

1. Be sure the clock is set to the correct time of day. Place food in the oven.
2. Turn the oven mode selector to **Bake**.
3. Turn the oven temperature selector to the desired bake temperature.
4. An acceptance chime will sound, the oven will start heating and the LED lights will stop blinking and remain on.
5. To enter Sabbath mode press and hold  for about 3 seconds. The control will sound an acceptance chime and **SAB** will appear in the display below the time of day.



**Figure 20:** Oven display showing Sabbath mode

**Note:** During the Sabbath mode all normal sounds of the oven control will be turned off. The oven light will turn off during the Sabbath mode and remain off until the Sabbath mode is canceled.

During Sabbath operation the oven temperature may be changed by adjusting the oven temperature selector. The oven will remain in Sabbath until canceled by the user. The Sabbath feature overrides the factory preset 12 hour energy saving feature.

### To turn off the Sabbath feature:

1. Turning the oven mode selector and the oven temperature selector to the **OFF** position will cancel Bake only.
2. To turn off the Sabbath feature press hold  for about 3 seconds.
3. The acceptance chime will sound and **SAB** will disappear from the display. Be sure both oven selectors are returned to the **OFF** positions

### Power failure while using Sabbath feature:

Should you experience a power failure or interruption, the oven will shut off. When power is returned, **SF** (Sabbath Failure) will be displayed, and the oven will not turn back on automatically. If your food was nearly fully cooked, you may allow the trapped heat in the oven to finish the cooking process. Otherwise, you should remove the food when the power failure occurs because you may only start the oven once during the Sabbath/Jewish holidays.

### To turn off the Sabbath feature:

1. Turn the oven mode selector and the oven temperature selector to the **OFF** position. This will cancel Bake only
2. Press and hold the  key for at least 3 seconds. **SAB** will disappear from the display, and the oven may be used with all normal functions.

## Setting Oven Controls

### Adjusting the Oven Temperature

The temperature in the oven is pre-set at the factory. When first using the oven, be sure to follow recipe times and temperatures.

**Important note:** Do not use oven thermometers such as those found in grocery stores to check the temperature settings inside your oven. These oven thermometers may vary as much as 20 to 40 degrees from actual temperatures.

Before adjusting, test a recipe by using a temperature setting higher or lower than the recommended temperature. The baking results should help you to decide how much of an adjustment is needed.

If you think the oven is cooking too hot or too cool for the temperature you select, you can adjust the actual oven temperature to be more or less than what is displayed by accessing the UPO (User Programmable Offset).

**Important:** Before making a temperature adjustment, make sure both the oven mode and oven temperature control knobs are in the OFF position. Changing the UPO will affect both oven cavities.

#### To adjust the oven temperature:

1. When the oven is idle, press and hold the light key for 3 seconds until the display sounds an acceptance chime. **AUD** should appear in the display.
2. Press the  key until **UPO** appears and the default setting of **0°** (or the last offset temperature) is showing.



Figure 21: UPO shown at default setting



3. Press the  or  key until the desired temperature change (offset) is reached. The display will change  $\pm 5^\circ$  with each key press to a maximum of  $+ 35^\circ$  or a minimum of  $- 35^\circ$ F.



Figure 22: UPO set to  $+10^\circ$  (L) and  $-10^\circ$  (R)

Once the new offset appears in the display, release the key and the control will accept the change.

4. To return the display to normal, press and hold  until an acceptance chime sounds. The display will return to show the time of day.

Note: Changing the UPO will not affect the broil or self clean temperatures.

### Restoring Factory Default Settings

Your appliance was set with predetermined (default) oven control settings. The following options have settings that can be modified and may have been changed since the appliance was new:

- Continuous bake or 12 hour energy savings mode (ES)
- Silent or audible control (Aud)
- Oven temperature adjustments (UPO)

#### To rest user preferences to original factory setting:



1. Press and hold the **light** key for 3 seconds until the display changes to show a user preference.
2. Use the  to scroll until **rST** appears.
3. Press the arrow key on the right side of the display until **yES** appears in the display and release the key.



Figure 23: Control ready to reset to default

4. The control will accept the change and all the user preferences will return to factory settings (default).
5. To exit the user preferences, press and hold the  for 3 seconds and the display will return to show the time of day.

**Important:** Choosing the **yES** reset option will return all user preferences to their default settings.

## Clean

A self cleaning oven cleans itself with high temperatures (well above normal cooking temperatures) which eliminate soils completely or reduces them to a fine powdered ash you can wipe away with a damp cloth.

### What to expect during self-cleaning

While in clean mode, sounds of metal expansion and contraction are normal. Odors are normal as the food soil is being removed. Smoke may appear through the oven vent. If heavy spills are not wiped up before cleaning, they may flame and cause more smoke and odor than usual. This is normal and safe and should not cause alarm. If available, use an exhaust fan during the self cleaning cycle. The timers do not function during a clean cycle.

### Important:

- Do not use oven cleaners or protective coatings in or around any part of the oven interior.
- Do not clean the oven door gasket. Take care not to rub, damage, or remove the gasket or use any cleaning substances on the oven door gasket (Figure 24). Doing so could cause damage and reduce the efficiency of the oven's performance.
- Clean any soil from the oven frame, door liner outside the oven door gasket, and the small area at the front center of the oven bottom with soap and water (See Figure 24).
- Remove any excessive spills from the oven cavity before starting the clean cycle. To clean, use hot, soapy water and a cloth. Large spills can cause heavy smoke or fire when subjected to high temperatures.
- Do not allow food spills with a high sugar or acid content (such as milk, tomatoes, sauerkraut, fruit juices, or pie filling) to remain on the surface as they may leave a dull spot even after cleaning.
- This model comes with lubricated porcelain oven racks which can remain in the oven during the self-clean cycle. Do not clean this vegetable lubrication off the racks. It is important that the sides of the oven racks always have a light coating of vegetable oil. To maintain optimal rack performance, re-apply a thin layer of vegetable oil to the sides of the rack after every self-clean cycle or when the rack becomes difficult to slide.
- The kitchen area should be well ventilated using an open window, ventilation fan or exhaust hood during the first clean cycle. This will help eliminate the normal odors associated with the first time a clean cycle is used.

**CAUTION** Do not line the oven walls, racks, bottom, or any other part of the oven with aluminum foil or with any other liners or materials. Doing so will block heat distribution, produce poor baking results, and cause permanent damage to the oven interior (aluminum foil will melt to the interior surface of the oven).

- The health of some birds is extremely sensitive to the fumes given off during the cleaning cycle of any oven. Move birds to another well-ventilated room.
- Remove all items from the oven including cookware, utensils, and any aluminum foil.
- During the cleaning cycle, the outside of the oven can become very hot to the touch.
- Do not leave small children unattended near the appliance. During self-clean the appliance may become very hot to the touch.
- Do not force the oven door open. This can damage the automatic door locking system.
- Use caution when opening the door after the cleaning cycle is completed. The oven may still be very hot.
- Stand to the side of the oven door when opening the door to allow hot air or steam to escape.

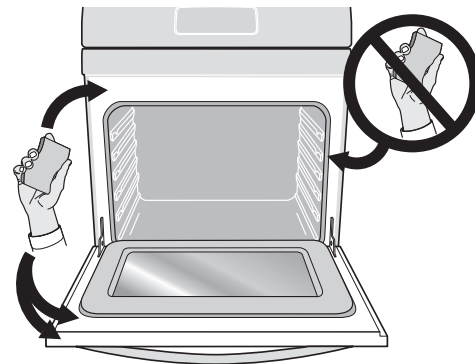

Figure 24: Cleaning around oven gasket

## Setting Oven Controls



### Setting the Clean Cycle Duration

It is recommended to use a 2 hour clean cycle for light soils, a 3 hour cycle for average soils, and a 4 hour cycle for heavy soils.

If you are planning to use the oven directly after a clean cycle, remember to allow time for the oven to cool down and the oven door to unlock. This normally takes about one hour. A 3 hour clean cycle will normally take about 4 hours to complete.

While one of the ovens is in the clean cycle, the other oven is disabled.

**To set the controls for a 3 hour cleaning cycle to start immediately and shut off automatically:**

1. Turn both the oven mode and oven temperature selectors to **Clean**. The display will show a 3 hour time (normal clean).
2. Use the  and  keys to select a 2 or 4 hour time if desired.
3. Once the control accepts a clean time, the **REMOVE RACKS** message will blink in the display. If the door is open the **CLOSE DOOR** message will also appear. If the user does not shut the door within 3 minutes of the display showing the door open message, the control will cancel the Clean function.

**Important:** It is recommended to remove all non-porcelain oven racks from the oven before starting a self-clean cycle, but the porcelain Glide rack may be left in the oven if the rack is soiled. After a self-clean cycle, or anytime the gliding is rough, the glide rack should be treated with graphite lubrication.

4. After the **REMOVE RACKS** message ends the oven door will begin locking. Do not attempt to open the door while the motor door latch mechanism is locking or when any locking indicators or displays are showing. The oven door should be completely locked in about 15 seconds.
5. **CLn** and the lock icon will appear in the display when the door is fully locked. The oven will start the Clean function.
6. The time left in the clean will be displayed under the **CLn** message.

**Important note:** To turn the clean cycle off at any time, turn the oven mode control and the oven temperature control to the **OFF** position.

### When the Clean time ends:

**Important:** Do not force the oven door open while the self clean is active. Do not open the oven door while the lock motor is running or when any locking indicators or displays are showing.

1. **CLn** will change to **Hot** in the display and the lock icon will remain visible. The oven door remains locked until the oven has cooled to a safe temperature and the motor door lock unlocks automatically.
2. When the temperature falls to the safe level, the display will fade out **Hot** from the timer display.
3. The lock icon will flash while the motor door latch mechanism is unlocking the door. Do not attempt to open the oven door until the lock icon disappears from the display.
4. The display will then fade in --- (dashes) to prompt user to rotate both the oven mode and temperature selector knobs to the **OFF** position.
5. The oven is now ready for normal use.

**CAUTION** The oven may still be very hot, to avoid possible burns be sure to stand to the side of the oven door when opening after a clean cycle to allow any heat or steam to escape.

The oven control will not allow back to back cleaning and is automatically set to delay for 4 hours before another clean may be attempted in the same oven cavity.

**Important note:** If Clean is active and a power failure occurs, the oven may not have thoroughly cleaned. This would depend on how much cleaning time had elapsed before the power failure. If needed after power is restored, set Clean again.

# Care and Cleaning

## Cleaning Various Parts of Your Oven

Before cleaning any part of the oven, ensure all controls are turned off and the oven is cool. Remove spills and any heavy soiling as soon as possible. Regular cleaning will reduce the difficulty and time of major cleaning later.

Surface Type	Recommendation
Aluminum, plastic, or vinyl trim Painted body parts Painted decorative trims Plastic	Use hot, soapy water and dry with a clean cloth. Use a soft cloth and clean with mild dish detergent and water or a 50/50 solution of vinegar and water. Follow by rinsing the area with clean water; dry and polish with a soft cloth. Glass cleaners may be used if sprayed on a soft cloth first. Do not spray liquids directly on the oven control and display area. Do not use large amounts of water on the control panel. Excess water on the control area may cause damage to the appliance. Do not use other liquid cleaners, abrasive cleaners, scouring pads, or paper towels. They will damage the finish.
Control panel Control keypad membrane Decorative trim (some models)	Use a soft cloth and clean with mild dish detergent and water or a 50/50 solution of vinegar and water. Follow by rinsing the area with clean water; dry and polish with a soft cloth. Glass cleaners may be used if sprayed on a soft cloth first. Do not spray liquids directly on the oven control and display area. Do not use large amounts of water on the control panel. Excess water on the control area may cause damage to the appliance. Do not use other liquid cleaners, abrasive cleaners, scouring pads, or paper towels. They will damage the finish.
Stainless Steel (some models)	Only use cleaners and polishes specifically manufactured for cleaning stainless steel. Always rub in direction of metal grain to avoid damaging. Do not use cleaners with high concentrations of chlorides or chlorine. Do not use harsh scrubbing cleaners. Polish with a lint-free cloth. Be sure to wipe excess cleaner/polish off from the metal surface as bluish stains may occur during future oven heating that cannot be removed. Clean heavier soils with hot, soapy water and a cloth or sponge. Use clean water to rinse; use a cloth to dry.
Porcelain enamel broiler pan and Insert (available by mail order) Door liner and body parts	Gentle scouring with a soapy scouring pad will remove most spots. Rinse with a 1:1 solution of clear water and ammonia. If necessary, cover difficult spots with an ammonia-soaked paper towel for 30 to 40 minutes. Rinse with clean water and a damp cloth, and then scrub with a soap-filled scouring pad. Rinse and wipe dry with a clean cloth. Remove all cleaners or the porcelain may become damaged during future heating.
Oven interior	Remove oven racks from the oven cavity before cleaning the oven interior. Use a mild, abrasive cleaner following manufacturer's instructions. Rinse with clean water and dry.
Porcelain oven racks Porcelain Glide racks	This model comes with lubricated porcelain oven racks which can remain in the oven during the self-clean cycle. Do not clean this vegetable lubrication off the racks. It is important that the sides of the oven racks always have a light coating of vegetable oil. To maintain optimal rack performance, re-apply a thin layer of vegetable oil to the sides of the rack after every self-clean cycle or when the rack becomes difficult to slide See " <a href="#">Caring for the glide racks</a> " on <a href="#">page 26</a> .
Oven door	Use soap and water to thoroughly clean the top, sides, and front of the oven door. Rinse well. You may use a glass cleaner on the outside door glass. Do not immerse the door in water. Do not spray or allow water or the glass cleaner to enter the door vents. Do not use oven cleaners, cleaning powders, or any harsh abrasive cleaning materials on the outside of the oven door.  The oven gasket is essential for a good seal. It is located on the inner frame of the door and visible when the door is opened. Do not clean the oven door gasket. On self clean models, the oven door gasket is made of a woven material. Care should be taken not to rub, damage, or remove this gasket.



## Care and Cleaning

### General Cleaning

Before manually cleaning any part of the oven, be sure all controls are turned off and the oven is cool. Ammonia must be rinsed before operating the oven. Provide adequate ventilation. Wear rubber gloves when cleaning the appliance manually. Remove spillovers and heavy soiling as soon as possible.

### Aluminum Foil, Aluminum Utensils, and Oven Liners

Never cover any slots, holes, or passages in the oven bottom or cover an entire oven rack with materials such as aluminum foil. Doing so blocks air flow through the oven and may cause carbon monoxide poisoning. Aluminum foil linings may trap heat, causing a fire hazard.

**Protective Liners**—Do not use aluminum foil or any other oven liners or materials to line the oven bottom. The high heat of the oven can melt these materials to the oven cavity and ruin the oven. These types of materials can also reduce the effectiveness of the air circulation in the oven and produce poor baking results.

- **Aluminum foil** - Only use aluminum foil as recommended in this manual. Improper installation of these liners may result in risk of electric shock or fire.
- **Oven racks** - Do not use aluminum foil to cover the oven racks. Using a liner in the oven restricts the heat and air flow needed to obtain the best possible cooking results for any oven.
- During self clean the oven temperature can become hot enough to melt aluminum cookware and utensils or aluminum foil if left in the oven. This could result in permanent damage to the oven interior and porcelain finish.

### Adhere to the following precautions when using spray oven cleaners:

- Do not spray cleaner on the electrical controls or switches because it could cause a short circuit and result in sparking or fire.
- Do not spray any cleaner on the oven door trim or gasket, broiler drawer glides, handles or any exterior surfaces of the oven, plastic or painted surfaces. The cleaner can damage these surfaces.

### Broiler Pan Cleaning Tips

To prevent grease from baking on, remove the broiler pan from the oven as soon as cooking is completed. Use hot pads because the broiler pan is extremely hot. Pour off grease. Soak the pan in hot, soapy water. Clean the broiler pan as soon as possible after each use. If necessary, use soap-filled steel wool pads. Heavy scouring may scratch the grid.

### Replacing the Oven Lights

The interior oven lights are located at the rear of the oven cavity and covered with a glass shield. The glass shield must be in place whenever the oven is in use (See [Figure 25](#)).

Be sure the oven is unplugged or power is turned off and all parts are cool before replacing oven light. Wear a leather-faced glove for protection against possible broken glass. Do not allow your fingers to touch the new bulb when replacing. This will shorten the life of the bulb. Use a paper towel or cotton glove while handling the new bulb when installing.

1. Turn electrical power off at the main source or unplug the appliance
2. Remove interior oven light shield by turning a quarter turn counter-clockwise.
3. Replace bulb with a new T-4 type Halogen 25 watt appliance bulb.
4. Replace glass oven light shield by rotating clockwise.
5. Turn power back on again at the main source (or plug the appliance back in).
6. Be sure to reset the time of day on the clock.

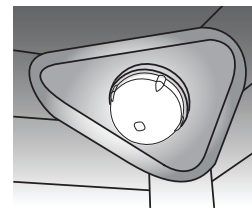

**Figure 25: Halogen light**

## Removing and Replacing the Oven Door

The door is heavy. For safe, temporary storage, lay the door flat with the inside of the door facing down.

To prevent possible burns, do not attempt to remove the oven door until the oven has completely cooled.

### To remove the oven door:

1. Open oven door completely, horizontal with floor (Figure 26).
2. Pull up the lock located on each hinge support toward front of the oven until the lock stops. You may have to apply a little pressure on the lock to pull it up (Figure 27 and Figure 28).
3. Grasp the door by the sides, and close the door until the door frame makes contact with unlocked hinges.
4. Pull the bottom of the door toward you while rotating the top of the door toward the appliance to completely disengage the hinge levers (Figure 29).

### To replace the oven door:

1. Firmly grasp both sides of oven door along the door sides. Do not use the oven door handle (Figure 29).
2. Hold the oven door at the same angle as the removal position. Carefully insert the hinge levers into the oven frame until you feel the hinge levers are seated into the hinge notches. The hinge arms must be fully seated into the hinge notches before the oven door can be fully opened.
3. Fully open the oven door, horizontal with floor (Figure 26).
4. Push the door hinge locks up toward and into the oven frame on both left and right oven door hinges to the locked position (Figure 27 and Figure 28).
5. Close the oven door.

### IMPORTANT!

**Special Door Care Instructions** - Most oven doors contain glass that can break.

### Read the following recommendations:

- Do not close the oven door until all the oven racks are fully in place.
- Do not hit the glass with pots, pans, or any other object.
- Scratching, hitting, jarring, or stressing the glass may weaken its structure causing an increased risk of breakage at a later time.

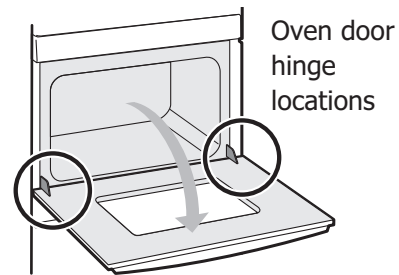

Figure 26: Location of hinges

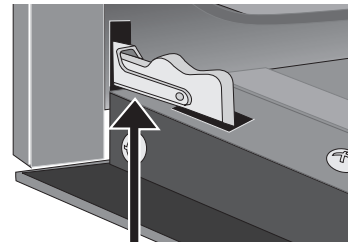

Figure 27: Hinge locked

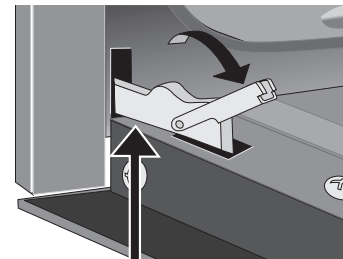

Figure 28: Unlocking hinge

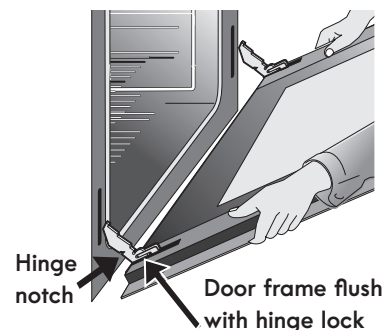

Figure 29: Remove (and replace) door

## Care and Cleaning

### Caring for the glide racks

**⚠ CAUTION** Handle oven racks only when they are cool. After cooking or after the self clean cycle, racks will be very hot and can cause burns.

#### Important notes:

- The Glide rack is porcelain enameled and may be left in the oven to be cleaned during the self-clean cycle. After the cycle, or anytime the gliding is rough, the Glide rack extension tracks should be treated with graphite lubrication.
- Do not use cooking oil, cooking spray, or other oil-based lubrication products on the glide rack extension tracks. Use only the graphite lubrication in this area. To order graphite lubrication, contact your installer, servicer, or dealer.
- The rack support (see step 7 image) on each side of the rack will contact the oven wall, and must always have a light coating of vegetable oil. Apply a thin layer of vegetable oil to the rack supports after every self clean or when the rack becomes difficult to reposition in the oven.

#### To lubricate the glide rack:

1. Remove the rack from the oven. Place the rack on a large flat surface covered with newspaper or scrap cloth. Fully extend the rack.
2. Wipe away debris and crumbs from the glide track using a cloth or sponge.

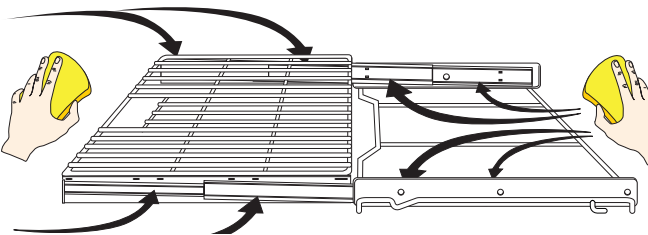

3. Shake graphite lubrication very well before applying. Place four drops of graphite lubrication along the bottom tracks (as shown in area circled in figure below). Repeat on both sides of the glide rack.

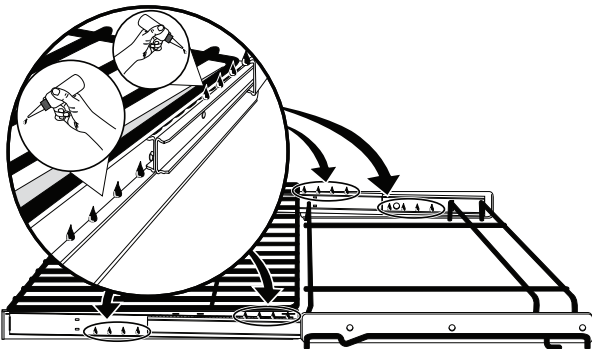

4. Extend and return the glide rack several times to distribute the lubricant.

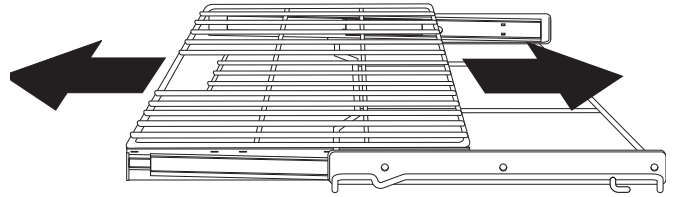

5. Turn glide rack over. Place four drops of graphite lubrication along the top tracks. Repeat on both sides of the glide rack.

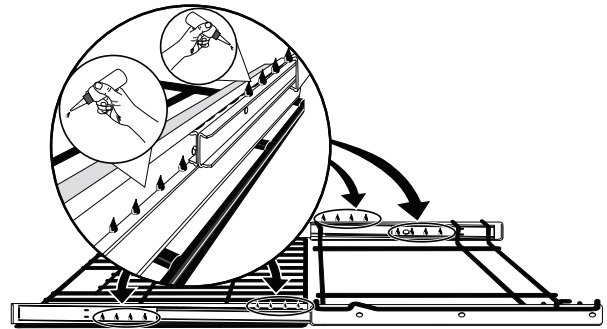

6. Extend and return the glide rack several times to distribute the lubricant.

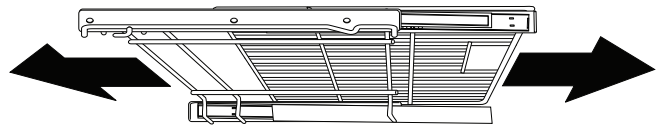

7. Apply a thin layer of vegetable oil to the rack support on each side of the glide rack. Keeping the rack supports lightly lubricated allows the entire rack to slide easily when changing rack positions.

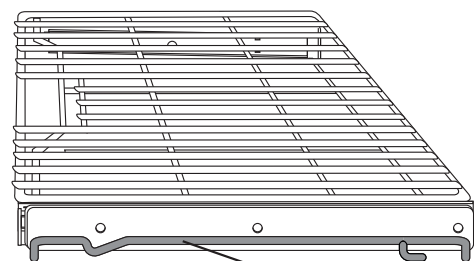





8. Replace rack in oven right-side up.

# BEFORE YOU CALL

For best cooking results, heat the oven before baking cookies, breads, cakes, pies, or pastries, etc. There is no need to preheat the oven for roasting meat or baking casseroles.

The cooking times and temperatures needed to bake a product may vary slightly from your previously owned appliance.

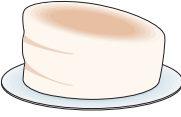
## Baking Problems and Solutions

Baking Problems	Causes	Corrections
Cookies and biscuits burn on the bottom. 	<ul style="list-style-type: none"> <li>• Cookies and biscuits put into oven before the preheating time is completed.</li> <li>• Oven rack is overcrowded or rack position too low.</li> <li>• Dark pans absorb heat too fast.</li> </ul>	<ul style="list-style-type: none"> <li>• Allow oven to preheat to desired temperature before placing food in oven.</li> <li>• Choose pan sizes that will permit 2" to 4" of air space (5.1 cm to 10.2 cm) on all sides when placed in the oven.</li> <li>• Use a medium weight baking sheet.</li> </ul>
Cakes too dark on top or bottom 	<ul style="list-style-type: none"> <li>• Cakes put in oven before preheating time is completed.</li> <li>• Rack position too high or too low.</li> <li>• Oven too hot.</li> </ul>	<ul style="list-style-type: none"> <li>• Allow oven to preheat to the selected temperature before placing food in the oven.</li> <li>• Use proper rack position for baking needs.</li> <li>• Set oven temperature 25°F (13°C) lower than recommended.</li> </ul>
Cakes not done in center 	<ul style="list-style-type: none"> <li>• Oven too hot.</li> <li>• Incorrect pan size.</li> <li>• Pan not centered in oven.</li> </ul>	<ul style="list-style-type: none"> <li>• Set oven temperature 25°F (13°C) lower than recommended.</li> <li>• Use pan size suggested in recipe.</li> <li>• Use proper rack position and place pan so there is 2" to 4" (5.1 cm to 10.2 cm) of space on all sides of pan.</li> </ul>
Cakes not level. 	<ul style="list-style-type: none"> <li>• Oven not level.</li> <li>• Pan too close to oven wall or rack overcrowded.</li> <li>• Pan warped.</li> <li>• Oven light left on while baking.</li> </ul>	<ul style="list-style-type: none"> <li>• Place a marked glass measuring cup filled with water on the center of the oven rack. If the water level is uneven, refer to the installation instructions for leveling the oven.</li> <li>• Be sure to allow 2" to 4" (5.1 cm to 10.2 cm) of clearance on all sides of each pan in the oven.</li> <li>• Do not use dented or warped pans.</li> <li>• Turn off oven light while baking.</li> </ul>
Foods not done when cooking time is over. 	<ul style="list-style-type: none"> <li>• Oven too cool.</li> <li>• Oven overcrowded.</li> <li>• Oven door opened too frequently.</li> </ul>	<ul style="list-style-type: none"> <li>• Set oven temperature 25°F (13°C) higher than suggested and bake for the recommended time.</li> <li>• Be sure to remove all pans from the oven except the ones to be used for baking.</li> <li>• Open the oven door only after shortest recommended baking time.</li> </ul>

## Before You Call

### Solutions to Common Problems

Before you call for service, review the following list. It may save you time and expense. Possible solutions are provided with the problem listed:

Problem	Solution
Oven control panel beeps and displays error codes	<ul style="list-style-type: none"><li>• Oven control has detected a fault or error condition. Press <b>STOP</b> to clear the error code.</li><li>• Oven control has detected a fault or error condition. When this occurs an E or F will show in the display. Turn both oven selectors to the OFF position.</li><li>• Try bake or broil function again.</li><li>• If the F or E code error repeats, turn off power to appliance, wait 5 minutes and then repower appliance. Set clock with correct time of day. Try bake or broil function again. If fault recurs, turn both selectors to OFF and call for service.</li></ul>
Poor baking results	<ul style="list-style-type: none"><li>• Many factors affect baking results.</li><li>• Use proper oven rack position.</li><li>• Center food in the oven and space pans to allow air to circulate. Preheat oven to the set temperature before placing food in the oven.</li><li>• If you feel the oven is too hot or cool, see <a href="#">“Adjusting the Oven Temperature”</a> on page 20.</li></ul>
AccelaHeat performs poorly	<ul style="list-style-type: none"><li>• AccelaHeat not used correctly. This cooking function is intended for convenience, precooked, and other specific foods. See <a href="#">“AccelaHeat”</a> on page 12 and follow best practices.</li></ul>
Appliance is not level.	<ul style="list-style-type: none"><li>• Be sure floor is level, strong and stable enough to adequately support oven. If floor is sagging or sloping, contact a carpenter to correct the situation.</li><li>• Kitchen cabinet alignment may make oven appear not level. Be sure cabinets are square and have sufficient room for appliance clearance.</li></ul>
Cannot move appliance easily.	<ul style="list-style-type: none"><li>• Cabinets not square or are built in too tight to allow clearance for appliance.</li><li>• Contact builder or installer to make appliance accessible.</li></ul>
Appliance does not operate.	<ul style="list-style-type: none"><li>• Make sure power cord is plugged properly into outlet. If electricity to home is working, check fuse box or breaker. Call your local electric company for service outage information.</li><li>• Service wiring is not complete. Call 1-844-553-6667 for service (see back cover).</li></ul>
Flames inside oven or smoking from oven vent.	<ul style="list-style-type: none"><li>• Excessive spills in oven. Grease or food spilled onto oven bottom or oven cavity. Wipe up excessive spills before starting oven.</li><li>• If flames or excessive smoke are present see <a href="#">“Using the Broil Feature”</a> on page 16.</li></ul>
Self Clean does not work	<ul style="list-style-type: none"><li>• Oven control not set properly. Make sure the oven door is closed.</li></ul>
Oven does not operate.	<ul style="list-style-type: none"><li>• The time of day is not set. The oven clock must first be set in order to operate the oven. See <a href="#">“Setting the Clock”</a> on page 10.</li><li>• Be sure oven controls are set properly. See <a href="#">“OVEN MODE SETTINGS”</a> beginning on page 9 and review instructions for the desired cooking function in this manual.</li></ul>
Soil not completely removed after Self Clean	<ul style="list-style-type: none"><li>• Excessive spills on oven bottom. Clean before starting Self Clean.</li><li>• Failure to clean soil from the oven frame, the door liner outside the gasket, and the small area at the front center of the oven bottom. These areas are not in the self cleaning area, but get hot enough to burn on residue. Clean these areas before starting the self cleaning cycle. Burned-on residue can be cleaned with a stiff nylon brush and water or a nylon scrubber. Be careful not to damage the oven gasket.</li></ul>

Oven smokes excessively when broiling	<ul style="list-style-type: none"> <li>• Incorrect setting. See <a href="#">“Using the Broil Feature”</a> on page 16.</li> <li>• Meat too close to the broil element. Reposition broil rack to provide proper clearance between the meat and broil element. Remove excess fat from meat. Cut remaining fatty edges to prevent curling, but do not cut into lean.</li> <li>• Grease build up on oven surfaces. Regular cleaning is necessary when broiling frequently. Grease or food splatters will cause excessive smoking.</li> </ul>
Oven racks do not slide easily	<ul style="list-style-type: none"> <li>• This model comes with lubricated porcelain oven racks which can remain in the oven during the self-clean cycle. Do not clean this vegetable lubrication off the racks. It is important that the sides of the oven racks always have a light coating of vegetable oil. To maintain optimal rack performance, re-apply a thin layer of vegetable oil to the sides of the rack after every self-clean cycle or when the rack becomes difficult to slide.</li> </ul>
Glide rack does not slide smoothly	<ul style="list-style-type: none"> <li>• Glide rack needs lubrication. For instructions on how to care for your Glide rack see <a href="#">“Caring for the glide racks”</a> on page 26.</li> </ul>
Oven light does not work.	<ul style="list-style-type: none"> <li>• Be sure the oven light is secure in the socket. See <a href="#">“Replacing the Oven Lights”</a> on page 24.</li> </ul>
Fan noise occurring after oven is turned off	<ul style="list-style-type: none"> <li>• Some models are equipped with a cooling fan that runs during the cooking process to cool internal electronic components. It is normal for this fan to continue to run for an extended period of time, even when the oven is off.</li> </ul>



## Master Protection Agreements

*Congratulations on making a smart purchase.* Your new Kenmore® product is designed and manufactured for years of dependable operation. But like all products, it may require preventive maintenance or repair from time to time. That's when having a Master Protection Agreement can save you money and aggravation.

The Master Protection Agreement also helps extend the life of your new product. Here's what the Agreement\* includes:

- ☑ **Parts and labor** needed to help keep products operating properly **under normal use**, not just defects. Our coverage goes **well beyond the product warranty**. No deductibles, no functional failure excluded from coverage – **real protection**.
- ☑ **Expert service** by a force of more than **10,000 authorized Sears service technicians**, which means someone you can trust will be working on your product.
- ☑ **Unlimited service calls and nationwide service**, as often as you want us, whenever you want us.
- ☑ **“No-lemon” guarantee** – replacement of your covered product if four or more product failures occur within twelve months.
- ☑ **Product replacement** if your covered product can't be fixed.
- ☑ **Annual Preventive Maintenance Check** at your request – no extra charge.
- ☑ **Fast help by phone** – we call it **Rapid Resolution** – phone support from a Sears representative on all products. Think of us as a “talking owner's manual”.
- ☑ **Power surge protection** against electrical damage due to power fluctuations.
- ☑ **\$250 Food Loss Protection** annually for any food spoilage that is the result of mechanical failure of any covered refrigerator or freezer.
- ☑ **Rental reimbursement** if repair of your covered product takes longer than promised.
- ☑ **25% discount** off the regular price of any non-covered repair service and related installed parts.

Once you purchase the Agreement, a simple phone call is all that it takes for you to schedule service. You can call anytime day or night, or schedule a service appointment online.

The Master Protection Agreement is a risk free purchase. If you cancel for any reason during the product warranty period, we will provide a full refund. Or, a prorated refund anytime after the product warranty period expires. Purchase your Master Protection Agreement today!

**Some limitations and exclusions apply. For prices and additional information in the U.S.A. call 1-800-827-6655.**

**\* Coverage in Canada varies on some items. For full details call Sears Canada at 1-800-361-6665.**

### Sears Installation Service

*For Sears professional installation* of home appliances, garage door openers, water heaters, and other major home items, in the U.S.A. call **1-844-553-6667**, and in Canada call **1-800-469-4663**.

## Acuerdos maestros de protección

*Enhorabuena por haber hecho una compra inteligente.* Su nuevo producto Kenmore® está diseñado y fabricado para brindarle años de funcionamiento fiable. Pero, como cualquier producto, puede necesitar mantenimiento preventivo o reparaciones periódicas. Es por eso que tener un Acuerdo maestro de protección podría ahorrarle dinero y molestias.

El Acuerdo maestro de protección también sirve para prolongar la durabilidad de su nuevo producto. El acuerdo\* incluye lo siguiente:

- ☑ **Piezas y mano de obra** necesarias para contribuir a mantener el funcionamiento adecuado de los productos **utilizados en condiciones normales de uso**, no sólo en caso de defectos de los productos. Nuestra cobertura va **mucho más allá que la garantía del producto**. No se aplican deducibles ni exclusiones por fallas del funcionamiento: es decir, **verdadera protección**.
- ☑ **Servicio técnico por expertos** (más de **10000 técnicos autorizados de Sears**), lo cual significa que quien repare o realice el mantenimiento de su producto será un profesional de confianza.
- ☑ **Servicio técnico a escala nacional y número ilimitado de llamadas de solicitud de servicio técnico**: se puede poner en contacto con nosotros cuantas veces lo desee y cuando lo desee.
- ☑ **Garantía “sin sorpresas”**: se reemplaza el producto cubierto por el acuerdo si ocurren cuatro o más fallas del producto en un periodo de 12 meses.
- ☑ **Reemplazo del producto**: en caso de que no se pueda reparar el producto cubierto por el acuerdo.
- ☑ **Revisión anual preventiva de mantenimiento del producto**: puede solicitarla en cualquier momento, sin costo alguno.
- ☑ **Rápida asistencia telefónica**, la cual denominamos **Solución rápida**: es decir, asistencia telefónica a través de cualquiera de nuestros representantes de Sears, sobre cualquiera de nuestros productos. Piense en nosotros como en un “manual parlante del usuario”.
- ☑ **Protección contra fallas eléctricas**, contra daños debidos a fluctuaciones de la corriente eléctrica.
- ☑ **\$250 al año para cubrir cualquier posible deterioro de alimentos** que haya tenido que desechar debido a una falla mecánica de cualquiera de nuestros refrigeradores o congeladores cubiertos por este acuerdo.
- ☑ **Devolución de gastos de alquiler de electrodomésticos** si la reparación de su producto asegurado toma más que el tiempo prometido.
- ☑ **25% de descuento** aplicable tanto a los costos del servicio de reparación, como de las piezas instaladas relacionadas que no hayan quedado cubiertos por este acuerdo.

Una vez que haya realizado el pago de este acuerdo, bastará una simple llamada telefónica para concertar una visita de servicio. Puede llamar a cualquier hora del día o de la noche, o bien concertar una visita de servicio por Internet.

La adquisición del Acuerdo maestro de protección es una inversión exenta de riesgos. Si por cualquier motivo decide cancelar dicho acuerdo durante el periodo de garantía del producto, le haremos un reintegro total del valor. O bien un importe proporcional si cancela el acuerdo en cualquier otro momento posterior al vencimiento del periodo de garantía del producto. ¡Adquiera hoy mismo su Acuerdo maestro de protección!

**Algunas limitaciones y exclusiones podrían aplicarse. Para solicitar precios e información adicional, llame al 1-800-827-6655 (en los EE.UU.).**

**\* La cobertura en Canadá varía en el caso de algunos artículos. Para obtener detalles completos al respecto, llame al 1-800-361-6665 de Sears de Canadá.**

### Servicio de instalación de Sears

*Para solicitar la instalación por profesionales de Sears* de electrodomésticos, abridores de puertas de garaje, calentadores de agua y otros artículos de uso prioritario en el hogar, llame al **1-800-553-6667** en los EE.UU. o llame al **1-800-469-4663** en Canadá.



# Kenmore®

For Sears Home Services in-home repair  
of all Kenmore major appliances.

For the replacement parts, accessories and  
Use & Care Guides that you need to do-it-yourself.

For professional installation of major home appliances  
and items like air conditioners and water heaters.

## 1-844-553-6667

[www.kenmore.com](http://www.kenmore.com)

In Canada 1-800-469-4663

[www.sears.ca](http://www.sears.ca)

---

Call anytime for the location of your nearest  
Sears Parts & Repair Service Center

1-800-488-1222 (U.S.A.)

1-800-469-4663 (Canada)

---

To purchase a protection agreement on a serviceable product :

1-800-827-6655 (U.S.A.)

1-800-361-6665 (Canada)

---

Para pedir servicio de reparación  
a domicilio, y ordenar piezas:

1-888-SU-HOGAR®

(1-888-784-6427)

[www.kenmore.com](http://www.kenmore.com)

Au Canada pour service en français:

1-800-LE-FOYER<sup>MC</sup>

(1-800-533-6937)

[www.sears.ca](http://www.sears.ca)



®