



Three-Speed Timed Bleach Automatic Washers

Use and Care Guide

Lavadoras automáticas con tres velocidades y distribución temporizada de blanqueador

Manual de Uso y Cuidado

Laveuses automatiques à trois vitesses Distribution d'eau de Javel minutée

Guide d'utilisation et d'entretien

ENGLISH

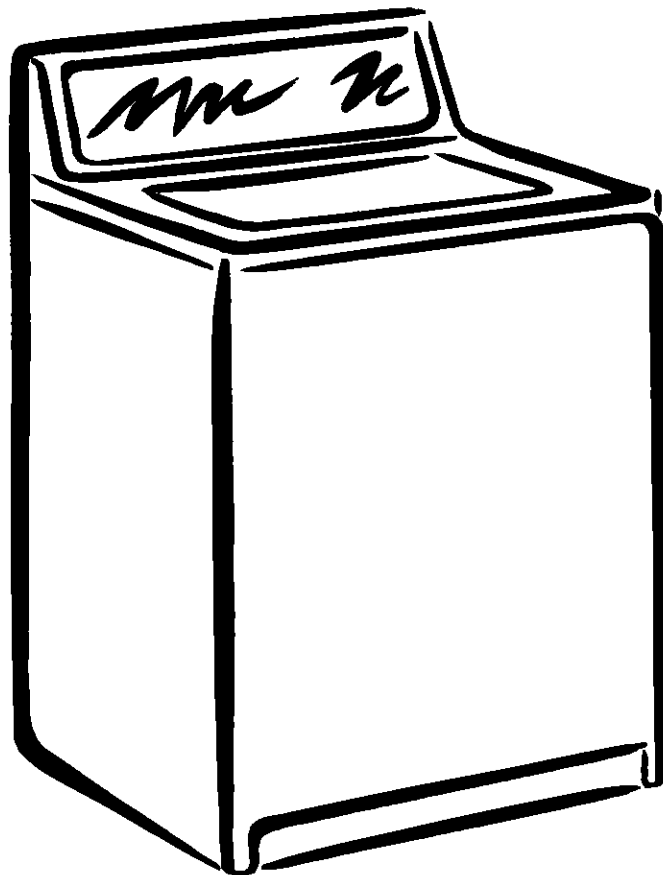

TABLE OF CONTENTS

SERVICE	2
In the U.S.A.....	2
In Canada.....	3
WARRANTY	3
WASHER SAFETY	4
INSTALLATION REQUIREMENTS	5
Tools and Parts.....	5
Location Requirements.....	5
Drain System.....	6
Electrical Requirements.....	6
INSTALLATION INSTRUCTIONS	7
Before You Start.....	7
Remove Shipping Strap.....	7
Connect Drain Hose.....	8
Connect the Inlet Hoses.....	8
Secure the Drain Hose.....	9
Level the Washer.....	9
Complete Installation.....	10
FEATURES AND BENEFITS	10
WASHER USE	11
Starting Your Washer.....	11
Selecting Wash/Spin Speeds.....	12
Selecting a Cycle and Time.....	13
Rinse and Spin.....	13
Drain and Spin.....	13
Understanding Washer Cycles.....	13
Normal Sounds.....	14
LAUNDRY TIPS	14
Loading.....	14
WASHER CARE	14
Cleaning Your Washer.....	14
Water Inlet Hoses.....	14
Vacation, Storage, and Moving Care.....	15
TROUBLESHOOTING	15

SERVICE

In the U.S.A.

Master Protection Agreements

Congratulations on making a smart purchase. Your new Kenmore® appliance is designed and manufactured for years of dependable operation. But like all products, it may require preventive maintenance or repair from time to time. That's when having a Master Protection Agreement can save you money and aggravation.

Purchase a Master Protection Agreement now and protect yourself from unexpected hassle and expense.

The Master Protection Agreement also helps extend the life of your new appliance. Here's what's included in the Agreement:

- ✓ **Expert service** by our 12,000 professional repair specialists
- ✓ **Unlimited service and no charge** for parts and labor on all covered repairs
- ✓ **"No-lemon" guarantee** – replacement of your covered product if more than three product failures occur within twelve months
- ✓ **Product replacement** if your covered product can't be fixed
- ✓ **Annual Preventive Maintenance Check** at your request – no extra charge
- ✓ **Fast help by phone** – non-technical and instructional assistance on products repaired in your home, plus convenient repair scheduling
- ✓ **Power surge protection** against electrical damage due to power fluctuations
- ✓ **Rental reimbursement** if repair of your covered product takes longer than promised

Once you purchase the Agreement, a simple phone call is all that it takes for you to schedule service. You can call anytime day or night, or schedule a service appointment online.

Sears has over 12,000 professional repair specialists, who have access to over 4.5 million quality parts and accessories. That's the kind of professionalism you can count on to help prolong the life of your new purchase for years to come. Purchase your Master Protection Agreement today!

Some limitations and exclusions apply. For prices and information call **1-800-827-6655**.

Sears Installation Service

For Sears guaranteed professional installation of home appliances and items like garage door openers and water heaters, in the U.S.A. call **1-800-4-MY-HOME®**.

In Canada

Your purchase has added value because you can depend on Sears HomeCentral® for service. With over 2,400 Service Technicians and access to over 900,000 parts and accessories, we have the tools, parts, knowledge and skills to back our pledge: We Service What We Sell.

Sears Maintenance Agreements

Your Kenmore® appliance is designed, manufactured and tested to provide years of dependable operation. Yet any major appliance may require service from time to time. The Sears Maintenance Agreement offers you an outstanding service program, affordably priced.

The Sears Maintenance Agreement

- Guarantees tomorrow's service at today's price.
- Eliminates repair bills resulting from normal wear and tear.
- Covers non-technical and instructional service calls.
- Provides an annual Preventive Maintenance Check, at your request, to ensure that your appliance is in proper running condition.

Some limitations apply. For information concerning Sears Home Central® Maintenance Agreements, call 1-800-361-6665.

KENMORE ELITE® WASHER WARRANTY

Limited Lifetime Warranty on White Porcelain Basket

For the lifetime of the washer from the date of purchase, Sears will replace the white porcelain wash basket if it chips or rusts due to defective material or workmanship. After the first year, you will be charged for labor.

Limited 10-Year Warranty on Plastic Tub*

For the second through tenth year from the date of purchase, Sears will replace the plastic tub if it is defective in material or workmanship. After the first year, you will be charged for labor.

Limited 5-Year Warranty on Gearcase Parts*

For the second through fifth year from the date of purchase, Sears will replace any gearcase parts that are defective in material or workmanship. After the first year, you will be charged for labor.

Limited 2-Year Warranty on SENSOR SMART™ Control Board

For two years from the date of purchase, Sears will replace the SENSOR SMART™ control board if it is defective in material or workmanship. You will be charged for labor after the first year.

Full 1-Year Warranty on Mechanical and Electrical parts

For one year from the date of purchase, when this washer is installed and operated according to the instructions that come with it, Sears will repair or replace any of its mechanical or electrical parts if they are defective in material or workmanship. Service must be provided by a Sears Service Department in the United States or Canada or an authorized agent.

Warranty Restriction

If this washer is operated for any purpose other than private family use, all warranty coverage is restricted to 90 days from the date of purchase.

Travel or transportation expenses for customers who reside in remote areas are not covered by this warranty.

Warranty Service

Warranty service is available by contacting the nearest Sears Service Center in the United States or Canada. This warranty applies only while the product is in use in the United States or Canada.

This warranty gives you specific legal rights and you may also have other rights which vary from state to state or province to province.

For Sears warranty information or to contact a Sears Service Center, please reference the service numbers located on the back page of this manual.

Sears, Roebuck and Co.
D/817WA, Hoffman Estates, IL 60179

Sears Canada Inc.
Toronto, Ontario, Canada M5B 2B8

* In Canada a different warranty may apply.

Product Record

In the space below, record your complete model number, serial number, and purchase date. You can find this information on the model and serial number label, as shown.

Have this information available to help you quickly obtain assistance or service when you contact Sears concerning your appliance.

Model number 110 _____

Serial number _____

Purchase date _____

Save these instructions and your sales receipt for future reference.

WASHER SAFETY

Your safety and the safety of others are very important.

We have provided many important safety messages in this manual and on your appliance. Always read and obey all safety messages.



This is the safety alert symbol.

This symbol alerts you to potential hazards that can kill or hurt you and others.

All safety messages will follow the safety alert symbol and either the word "DANGER" or "WARNING." These words mean:

⚠ DANGER

You can be killed or seriously injured if you don't immediately follow instructions.

⚠ WARNING

You can be killed or seriously injured if you don't follow instructions.

All safety messages will tell you what the potential hazard is, tell you how to reduce the chance of injury, and tell you what can happen if the instructions are not followed.

IMPORTANT SAFETY INSTRUCTIONS

WARNING: To reduce the risk of fire, electric shock, or injury to persons when using the washer, follow basic precautions, including the following:

- Read all instructions before using the washer.
- Do not wash articles that have been previously cleaned in, washed in, soaked in, or spotted with gasoline, dry-cleaning solvents, other flammable, or explosive substances as they give off vapors that could ignite or explode.
- Do not add gasoline, dry-cleaning solvents, or other flammable, or explosive substances to the wash water. These substances give off vapors that could ignite or explode.
- Under certain conditions, hydrogen gas may be produced in a hot water system that has not been used for 2 weeks or more. **HYDROGEN GAS IS EXPLOSIVE.** If the hot water system has not been used for such a period, before using the washing machine, turn on all hot water faucets and let the water flow from each for several minutes. This will release any accumulated hydrogen gas. As the gas is flammable, do not smoke or use an open flame during this time.
- Do not allow children to play on or in the washer. Close supervision of children is necessary when the washer is used near children.
- Before the washer is removed from service or discarded, remove the door or lid.
- Do not reach into the washer if the drum, tub or agitator is moving.
- Do not install or store the washer where it will be exposed to the weather.
- Do not tamper with controls.
- Do not repair or replace any part of the washer or attempt any servicing unless specifically recommended in this manual or in published user-repair instructions that you understand and have the skills to carry out.
- See "Electrical Requirements" for grounding instructions.

SAVE THESE INSTRUCTIONS

INSTALLATION REQUIREMENTS

Tools and Parts

Assemble the necessary tools and supplies before beginning the washer installation. The parts supplied are in the washer basket.

Tools needed for connecting the drain hose and water inlet hoses:

- Pliers that open to 1 $\frac{1}{16}$ in. (3.95 cm)
- Flashlight (optional)

Parts supplied:

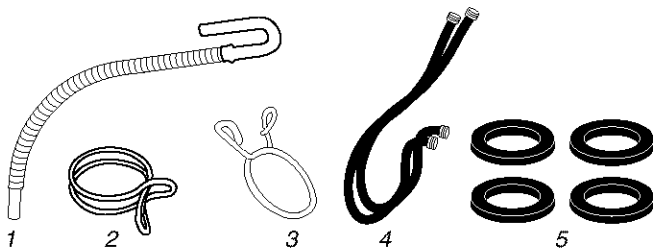

1. Drain hose
2. Silver, double-wire hose clamp (for the bottom of the drain hose)
3. Yellow, single-wire hose clamp (for the top of the drain hose)
4. Water inlet hoses (2)
5. Flat water inlet hose washers (4)

Tools needed for securing the drain hose and leveling the washer:

- Adjustable or open end wrench $\frac{9}{16}$ in. (14 mm)
- Level
- Wood block
- Ruler or measuring tape

Parts supplied:

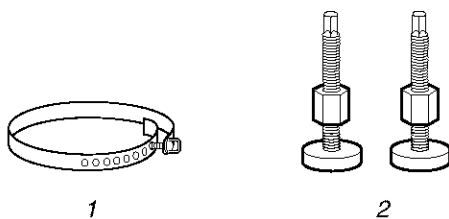

1. Shipping strap with fastener
2. Front leveling feet with nuts (2)

Alternate Parts

Parts listed are available from your local Sears store or Sears Service Center. For further information, please call **1-800-4-MY-HOME® (1-800-469-4663)**.

If You Have:	You Will Need to Buy:
Laundry tub or standpipe taller than 96 in. (2.4 m)	Sump pump system (if not already available)
1 in. (2.5 cm) diameter standpipe	2 in. (5 cm) diameter to 1 in. (2.5 cm) diameter standpipe adapter, Part No. 3363920
Overhead sewer	Standard 20 gal. (76 L) 39 in. (99 cm) tall drain tub or utility sink, sump pump and connectors (available from local plumbing suppliers)
Floor drain	Siphon break, Part Number 285320; additional drain hose, Part Number 3357090 and connector kit, Part Number 285442
Water faucets beyond reach of fill hoses	2 longer water fill hoses: 6 ft (1.8 m) Part Number 76314, 10 ft (3.0 m) Part Number 350008
Drain hose too short	Drain hose, Part No. 388423 and hose kit, Part No. 285442
Drain hose that is too long	Hose kit, Part No. 285442
Lint clogged drain	Drain protector, Part No. 367031

Location Requirements

Selecting the proper location for your washer improves performance and minimizes noise and possible washer "walk."

Your washer can be installed in a basement, laundry room, closet, or recessed area. (See "Drain System.")

IMPORTANT: Do not install or store the washer where it will be exposed to the weather.

Proper installation is your responsibility.

You will need:

- A water heater set to deliver 120°F (49°C) water to the washer.
- A grounded electrical outlet located within 4 ft (1.2 m) of where the power cord is attached to the back of the washer. (See "Electrical Requirements.")
- Hot and cold water faucets located within 4 ft (1.2 m) of the hot and cold water fill valves, and water pressure of 5-100 psi (34.5-690 kPa). Washers with triple dispensers require 20-100 psi (138-690 kPa) for best performance.
- A level floor with a maximum slope of 1 in. (2.5 cm) under entire washer. Installing the washer on carpeting is not recommended.
- A sturdy floor to support the washer weight (washer, water and load) of 315 lbs (143 kgs).

Do not store or operate your washer in temperatures at or below 32°F (0°C). Some water can remain in the washer and can cause damage in low temperatures. See "Washer Care" for winterizing information.

Recessed area or closet installation

The dimensions shown are for the recommended spacing allowed, except the closet door ventilation openings. The dimensions shown for the closet door ventilation openings are the minimum required.

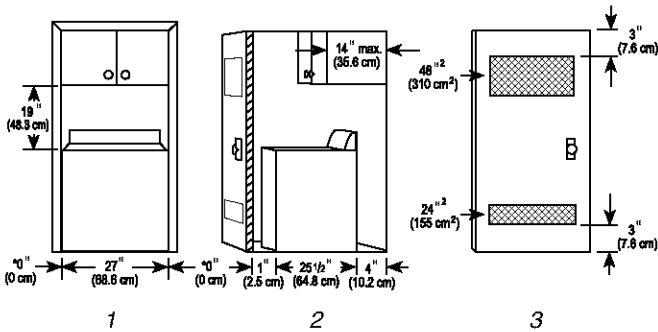

1. Front view
2. Side view
3. Closet door with vents

- Additional spacing should be considered for ease of installation and servicing.
- Additional clearances may be required for wall, door and floor moldings.
- Additional spacing of 1 in. (2.5 cm) on all sides of the washer is recommended to reduce noise transfer.
- If a closet door is installed, the minimum air openings in the top and bottom of the door are required. Louvered doors with air openings in the top and bottom are acceptable.
- Companion appliance spacing should also be considered.

Drain System

The washer can be installed using the standpipe drain system (floor or wall), the laundry tub drain system, or the floor drain system. Select the drain hose installation method you need. See "Alternate Parts."

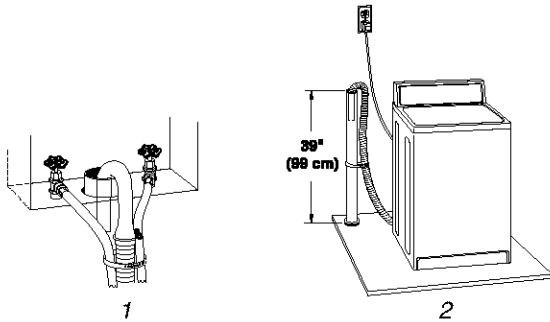

Standpipe drain system - wall or floor (view 1 & 2)

The standpipe drain requires a minimum diameter standpipe of 2 in. (5 cm). The minimum carry-away capacity can be no less than 17 gal. (64 L) per minute. A 2 in. (5 cm) diameter to 1 in. (2.5 cm) diameter standpipe adapter kit is available. See "Alternate Parts."

The top of the standpipe must be at least 39 in. (99 cm) high and no higher than 96 in. (244 cm) from the bottom of the washer.

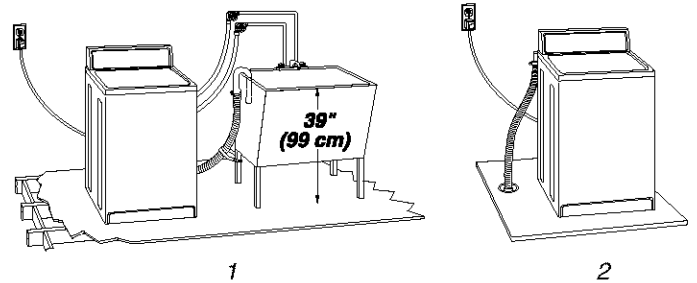

Laundry tub drain system (view 1)

The laundry tub needs a minimum 20 gal. (76 L) capacity. The top of the laundry tub must be at least 39 in. (99 cm) above the floor and no higher than 96 in. (244 cm) from the bottom of the washer.

Floor drain system (view 2)

The floor drain system requires a siphon break that may be purchased separately. See "Alternate Parts."

The siphon break must be a minimum of 28 in. (71 cm) from the bottom of the washer. Additional hoses might be needed.

Electrical Requirements

⚠ WARNING



Electrical Shock Hazard

Plug into a grounded 3 prong outlet.

Do not remove ground prong.

Do not use an adapter.

Do not use an extension cord.

Failure to follow these instructions can result in death, fire, or electrical shock.

- A 120-volt, 60-Hz., AC-only, 15- or 20-ampere, fused electrical supply is required. Time-delay fuse or circuit breaker is recommended. It is recommended that a separate circuit serving only this appliance be provided.
- This washer is equipped with a power supply cord having a 3 prong ground plug.
- To minimize possible shock hazard, the cord must be plugged into a mating, 3 prong, ground-type outlet, grounded in accordance with local codes and ordinances. If a mating outlet is not available, it is the personal responsibility and obligation of the customer to have the properly grounded outlet installed by a qualified electrician.

- If codes permit and a separate ground wire is used, it is recommended that a qualified electrician determine that the ground path is adequate.
- Do not ground to a gas pipe.
- Check with a qualified electrician if you are not sure the washer is properly grounded.
- Do not have a fuse in the neutral or ground circuit.

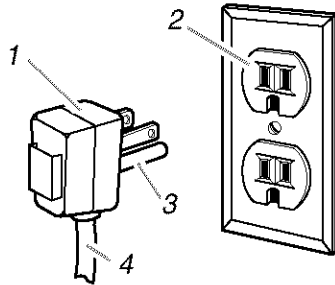

1. 3 prong grounding plug
2. 3 prong grounding-type outlet
3. Ground prong
4. Power supply cord

GROUNDING INSTRUCTIONS

For a grounded, cord-connected washer:

This washer must be grounded. In the event of a malfunction or breakdown, grounding will reduce the risk of electrical shock by providing a path of least resistance for electric current. This washer is equipped with a cord having an equipment-grounding conductor and a grounding plug. The plug must be plugged into an appropriate outlet that is properly installed and grounded in accordance with all local codes and ordinances.

WARNING: Improper connection of the equipment-grounding conductor can result in a risk of electric shock. Check with a qualified electrician or serviceman if you are in doubt as to whether the appliance is properly grounded.

Do not modify the plug provided with the appliance – if it will not fit the outlet, have a proper outlet installed by a qualified electrician.

For a permanently connected washer:

This washer must be connected to a grounded metal, permanent wiring system, or an equipment grounding conductor must be run with the circuit conductors and connected to the equipment-grounding terminal or lead on the appliance.

INSTALLATION INSTRUCTIONS

Before You Start

⚠ WARNING

Excessive Weight Hazard

Use two or more people to move and install washer.

Failure to do so can result in back or other injury.

- To prevent floor damage, set the washer onto cardboard before moving across floor.
- Move the washer to within approximately 3 ft (90 cm) of the final location.

Remove Shipping Strap

Removing the shipping strap is necessary for smooth operation. If the shipping strap is not removed, the washer will make excessive noise.

1. Do not cut yellow strap. Pull yellow strap firmly, until completely removed from washer. Depending on your model, there will be either two or three cotter pins on the end of the shipping strap when it is pulled out of the washer. The electrical plug is attached to this shipping strap.

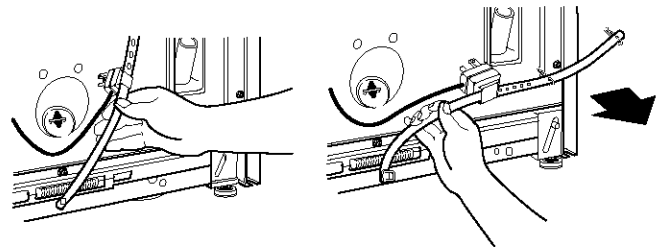

2. Pull firmly to remove the end of the shipping strap that remains pinned to the back of the washer. This will release the rear self-leveling feet.

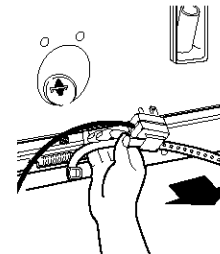

- Cut the shipping strap about 16 in. (41 cm) from plug end. Look for the words "CUT HERE." Discard end with the cotter pins. Slide remainder of shipping strap from the power cord. You will use the remainder of the shipping strap later to secure the drain hose.

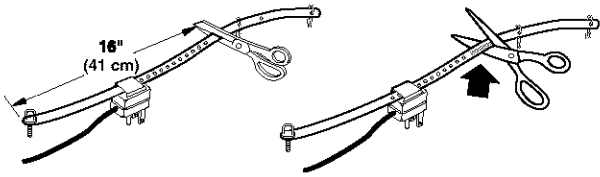

Connect Drain Hose

Proper connection of the drain hose will protect your floors from damage due to water leakage. To prevent the drain hose from coming off or leaking, it must be installed per the following instructions.

IMPORTANT: To ensure proper installation, this procedure must be followed exactly.

- Check the drain hose to see if it is the proper length.
- Wet the inside of the straight end of the drain hose with tap water. **DO NOT USE ANY OTHER LUBRICANT.**
- Squeeze ears of silver, double-wire clamp with pliers to open. Place clamp over the straight end of the drain hose 1/4 in. (6 mm) from the end.

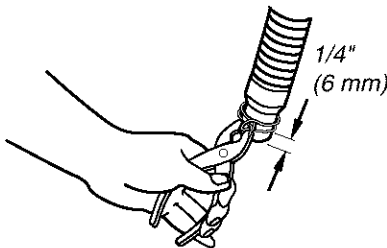

- Open clamp. Twist hose back and forth while pushing down onto drain connector at the bottom of the washer. Continue until hose contacts the ribbed stop on the cabinet.

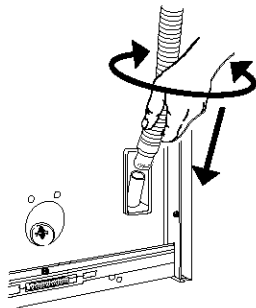

- Place clamp over area marked "CLAMP." Release clamp.

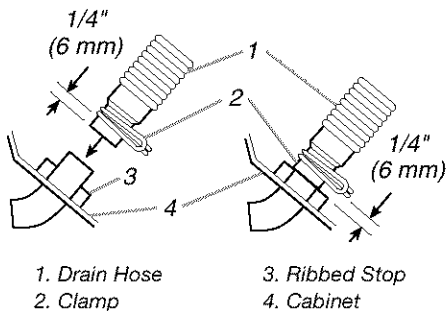

For standpipe or laundry tub drain systems:

- Open yellow, single-wire clamp with pliers and slide over hooked end of drain hose to secure the rubber and corrugated sections together.

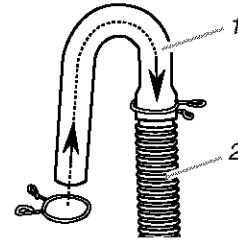

1. Hooked end
2. Drain hose

- Put hooked end of drain hose into laundry tub or standpipe. Rotate hook to eliminate kinks.

To prevent drain water from going back into the washer:

- Do not straighten hooked end of drain hose. Do not force excess drain hose into standpipe. Hose should be secure, but loose enough to provide a gap of air.
- Do not lay excess drain hose in bottom of laundry tub.

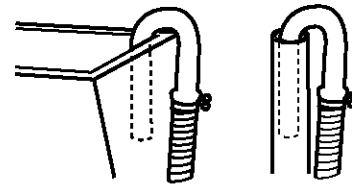

- For floor drain installation, see kit number required under "Alternate Parts."

Connect the Inlet Hoses

- Insert new flat washers (supplied) into each end of the inlet hoses. Firmly seat the washers in the couplings.

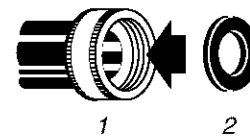

1. Coupling
2. Washer

Connect the inlet hoses to the water faucets

Make sure the washer basket is empty.

- Attach the hose with the red coupling to the hot water faucet. Screw on coupling by hand until seated on the washer.
- Attach the hose with the blue coupling to the cold water faucet. Screw on coupling by hand until seated on the washer.

- Using pliers, tighten the couplings with an additional two-thirds turn.

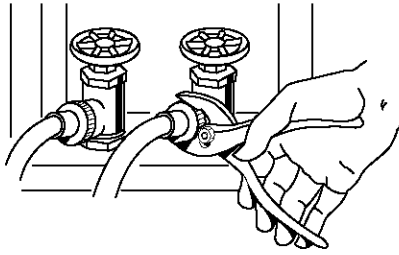

NOTE: Do not overtighten. Damage to the valves can result.

Clear the water lines

- Run water through both faucets and inlet hoses, into a bucket or laundry tub, to get rid of particles in the water lines that might clog the inlet valve screens.

Connect the inlet hoses to the washer

- Attach the hose with the red coupling to the HOT (bottom) inlet valve. Attaching the red coupling first makes it easier to tighten connection with pliers. Screw on coupling by hand until seated on the washer. Using pliers, tighten the couplings with an additional two-thirds turn.

NOTE: Do not overtighten. Damage to the valves can result.

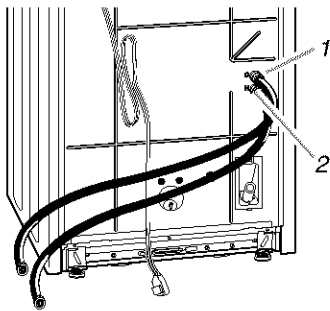

- Cold water inlet valve (blue)
- Hot water inlet valve (red)

NOTE: The inlet valve may be on the right or the left side of the washer, depending on your model.

- Attach the hose with the blue coupling to the COLD water (top) inlet valve. Screw on coupling by hand until seated on the washer. Using pliers, tighten the couplings with an additional two-thirds turn.

NOTE: Do not overtighten. Damage to the valves can result.

Check for leaks

- Turn on the water faucets and check for leaks. A small amount of water might enter the washer. You will drain this later.

NOTE: Replace inlet hoses after 5 years of use to reduce the risk of hose failure. Record hose installation or replacement dates for future reference.

- If you connect only one water hose, you must cap off the remaining water inlet port.
- Periodically inspect and replace hoses if bulges, kinks, cuts, wear, or leaks are found.

Secure the Drain Hose

1. Drape the power cord over the console.
2. Remove any cardboard used to move washer.
3. Locate the remaining portion of shipping strap (not the end with the cotter pins) from step 3 of "Remove Shipping Strap."

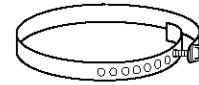

Remaining portion of Shipping Strap

4. Wrap the drain hose to the laundry tub leg or standpipe with the tie strap. Push fastener into the nearest hole in the shipping strap. (See illustration 1 or 2.)

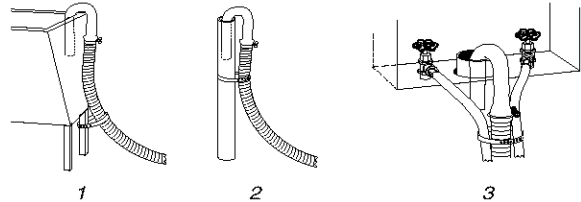

If the washer faucets and the drain standpipe are recessed, put the hooked end of the drain hose in the standpipe. Tightly wrap the tie strap around the water inlet hoses and the drain hose. (See illustration 3.)

Level the Washer

Properly leveling your washer prevents excessive noise and vibration.

Install the front leveling feet

1. Prop up the front of the washer about 4 in. (10.2 cm) with a wood block or similar object. The block needs to support the weight of the washer.
2. Screw the lock nut onto each foot to within 1 in. (2.5 cm) of the base.

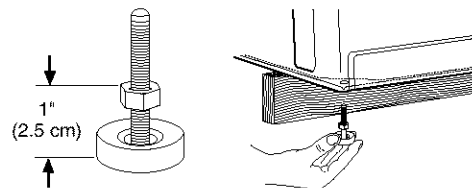

3. Screw the feet into the correct holes at the front corner of the washer until the nuts touch the washer.

NOTE: Do not tighten the nuts until the washer is level.

4. Tilt the washer back and remove the wood block. Gently lower the washer to the floor.
5. Slide to final location.
6. Tilt the washer forward until the rear of the washer is at least 4 in. (10.2 cm) off the floor. You may hear the self-adjusting rear feet click into place. Lower the washer to the floor.
7. Check the levelness of the washer by placing a level on the top edges of the washer, first side-to-side, then front-to-back.

- If the washer is not level, move the washer out slightly, tip back, prop up the front of the washer with the wood block and adjust the feet up or down as necessary. Repeat steps 5 through 8 until washer is level.

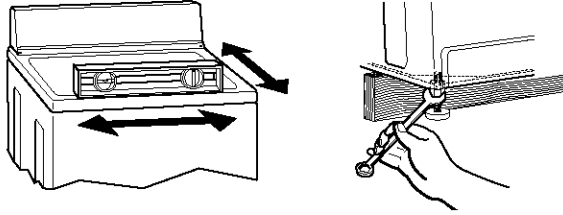

- After the washer is in the final location and level, use a $\frac{9}{16}$ in. (14 mm) open-end wrench to turn the nuts on the feet tightly against the washer cabinet.

If the nuts are not tight against the washer cabinet, the washer may vibrate.

Complete Installation

- Check the electrical requirements. Be sure that you have the correct electrical supply and the recommended grounding method. (See “Electrical Requirements.”)
- Check to be sure all parts are now installed. If there is an extra part, go back through the steps to see which step was skipped.
- Check to be sure you have all of your tools.
- Check to be sure that the yellow shipping strap was removed from the back of the washer and used to secure the drain hose.
- Dispose/recycle all packaging materials.
- Check to be sure the water faucets are on.
- Check for leaks around faucets and inlet hoses.

⚠ WARNING



Electrical Shock Hazard

Plug into a grounded 3 prong outlet.

Do not remove ground prong.

Do not use an adapter.

Do not use an extension cord.

Failure to follow these instructions can result in death, fire, or electrical shock.

- Plug into a grounded 3 prong outlet.
- Remove the protective film on the console and any tape remaining on the washer.
- Read “Washer Use” in the Washer User Instructions.
- To test your washer, measure $\frac{1}{2}$ of the normal recommended amount of powdered or liquid detergent and pour it into the washer basket or detergent dispenser (on some models). Close the lid. Select any cycle, and then press START. Allow it to complete one whole cycle.

FEATURES AND BENEFITS

Your new washer has many special features that contribute to proper cleaning and fabric care. Here are descriptions of the features and their benefits:

TOTAL CARE™ Agitator

The TOTAL CARE™ Agitator moves in three directions to ensure proper cleaning. At the bottom of your washer the agitator vanes move back and forth to flex the fabric, loosening the soil. The upper portion of the agitator has vanes that push the clothes down in a spiraling pattern to the area of best cleaning action. A “roll-over” motion displaces the clothes already at the bottom. For your largest loads, the TOTAL CARE™ Agitator responds with a vertical motion that senses the “large load” and guides items to the bottom.

KING SIZE™ Capacity

Your washer can handle full-sized loads of heavy work clothes, towels, or mixed items (see “Loading”). Loads with only a few items can have a lower water level setting and need less wash time.

Ultra Rinse System

Your washer allows you to add an automatic second rinse to the Ultra Clean cycle and to the Permanent Press II cycle. Set the Rinse Options control on 2nd rinse before you start the washer. You can also select a “Rinse and Spin” option.

QUIET PAK™ II System

The QUIET PAK™ System is designed to reduce water sounds and ringing noises. The cabinet is insulated with three sound-damping materials for superior vibration and sound-damping characteristics.

Timed Bleach Dispenser

The liquid chlorine bleach dispenser automatically dispenses bleach at the proper time in the cycle to ensure the cleanest and brightest loads. The dispenser is for liquid chlorine bleach only. Do not use this dispenser to add powdered chlorine or color-safe bleach to your washer load.

Wash/Spin Speeds

Six combinations of speeds are provided for wash action (of agitator) and spin motion (of basket). A Speeds selector control knob lets you select a wash/spin speed for different types of fabrics and soil levels.

Water Level and Temperature

A Water Level control gives you the flexibility to save water when washing small loads. The Water Temperature control knob lets you select a wash and rinse water temperature setting based on the type of load you are washing. The settings for Automatic Temperature Control (ATC) take away the worry of undissolved detergent and ensure consistent cleaning results from season to season with warm and cold washes.

WASHER USE

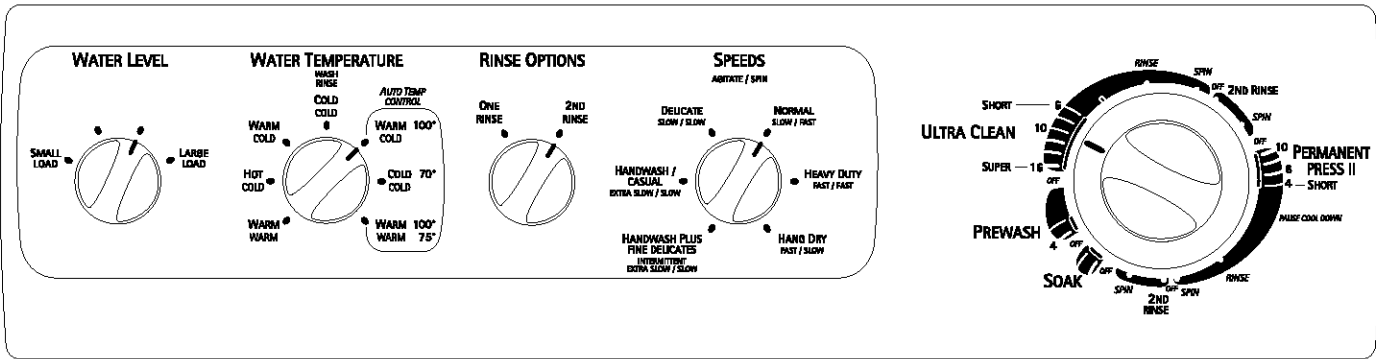

Starting Your Washer

⚠ WARNING



Fire Hazard

Never place items in the washer that are dampened with gasoline or other flammable fluids.

No washer can completely remove oil.

Do not dry anything that has ever had any type of oil on it (including cooking oils).

Doing so can result in death, explosion, or fire.

WARNING: To reduce the risk of fire, electric shock, or injury to persons, read the IMPORTANT SAFETY INSTRUCTIONS before operating this appliance.

The following is a guide to starting your washer. Periodic references to other sections of this manual provide more detailed information.

1. Measure detergent and pour it into the washer.

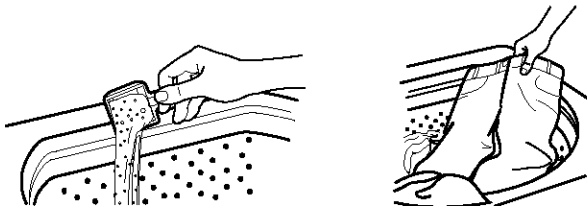

Drop a sorted load of clothes loosely into your washer.

- Load evenly to maintain washer balance. Mix large and small items.
- Items should move easily through the wash water. Overloading can cause poor cleaning.

- To reduce wrinkling of permanent press clothes and some synthetic knits, use the Large Load setting to provide more space (see step 5).
2. (OPTIONAL STEP) Pour measured liquid chlorine bleach into the liquid chlorine bleach dispenser. Bleach will be dispensed automatically during the wash part of the cycle.

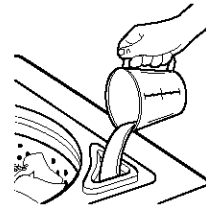

- Never use more than 1 cup (250 mL) for a full load. Use less for a smaller load size.
 - Follow the manufacturer's directions for safe use.
 - To avoid spilling, use a cup with a pouring spout. Do not let bleach splash, drip, or run down into the washer basket.
 - Use only liquid chlorine bleach in this dispenser.
3. (OPTIONAL STEP) Pour measured liquid fabric softener into the liquid fabric softener dispenser. Softener is added automatically during the rinse portion of the cycle.

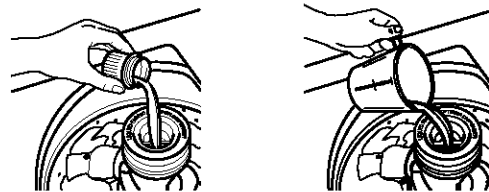

Dilute liquid fabric softener by filling the dispenser with warm water until liquid reaches the bottom of the opening of the funnel-shaped portion of the dispenser.

- Do not spill or drip any fabric softener on the clothes.
 - Use only liquid fabric softener in this dispenser.
4. Close the washer lid.
 5. Turn the Water Level selector to the correct setting for your wash load and the type of fabric being washed.
 - Choose a water level that allows the load to move freely for best fabric care. See "Loading."

- You may change to a higher level setting after the washer has started filling by turning the knob to a different setting.

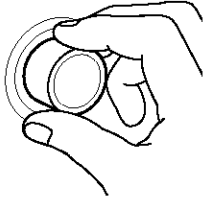

- Set the Water Temperature selector to the correct setting for the type of fabric and soils being washed. Use the warmest water safe for fabric. Follow garment label instructions.

Water Temp	Use for
Hot 111°F (44°C) or above	Whites and pastels Heavy soils
Warm 90°-110°F (32°-43°C)	Bright colors Moderate to light soils
Cold 70°-90°F (21°-32°C)	Colors that bleed or fade Light soils

NOTE: In wash water temperatures colder than 70°F (21°C), detergents do not dissolve well. Soils can be difficult to remove. Some fabrics can retain wear wrinkles and have increased pilling (the formation of small lint-like balls on the surface of garments).

(OPTIONAL) An Automatic Temperature Control (ATC) electronically senses and maintains a uniform water temperature by regulating incoming hot and cold water.

- Even in cold wash, some warm water is let into the washer to maintain a minimum temperature of 70°F (21°C).
 - Warm wash is maintained at approximately 100°F (38°C).
 - Warm rinse is maintained at approximately 75° (24°C) for all warm rinse settings.
- (OPTIONAL STEP) For a second rinse at the end of the Ultra Clean cycle or the Permanent Press II cycle, turn the Rinse Options selector to 2nd Rinse.
 - Set the Speeds Control knob according to the type of fabric in the load. See “Selecting Wash/Spin Speeds.”
 - Push in the Cycle Selector Control (Timer) knob and turn it clockwise to the wash cycle you want. Reduce the wash time when using a small load side setting. See “Selecting a Cycle and Time.”



Pull out the Cycle Selector Control (Timer) knob to start the washer.

To stop or restart your washer

- To stop the washer at any time, push in the Cycle Selector Control (Timer) knob.
- To restart the washer, close the lid (if open) and pull out the Cycle Selector Control (Timer) knob.

Selecting Wash/Spin Speeds

This section describes the wash/spin speeds you can select with the Speeds control. Each speed setting is designed for different types of fabric and soil levels.

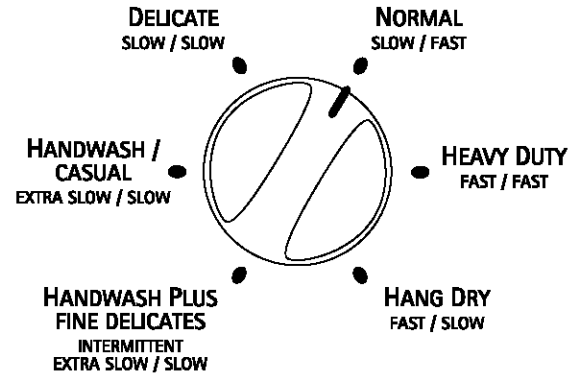

Speeds Selector knob

Normal speed

This speed setting is for normally soiled cottons and linens. Setting combines slow speed agitation and fast spin speeds to shorten drying time.

Heavy Duty speed

This speed setting is for sturdy or heavily soiled loads. Setting combines fast speed agitation and fast spin speeds.

Hang Dry speed

This speed setting is for sturdy permanent press fabrics that will be line dried. Setting combines fast speed agitation and slow spin speeds to reduce wrinkling.

Handwash Plus Fine Delicates speed

Use this speed setting for hand washable and special-care items. The wash action has repeating periods of extra-slow speed agitation and soaking. Slow spin speeds help reduce wrinkling.

NOTE: Do not use this cycle for large items such as blankets. Some “Hand Wash” items, particularly wool, naturally shrink when washed. When still wet, block these items by gently stretching to original measurements. Allow the items to dry flat.

Handwash/Casual speed

This speed setting is for lingerie and loosely knit items. Setting combines extra-slow speed agitation for gentle soil removal and slow spin speeds to reduce wrinkling.

Delicate speed

This speed setting is for washable knit fabrics and permanent press fabrics. Setting combines slow speed agitation for gentle soil removal and slow spin speeds to reduce wrinkling.

Selecting a Cycle and Time

This section describes the available wash cycles and will help you make the best cycle selections for your wash loads. Each cycle is designed for different types of fabric and soil levels.

- The washer pauses briefly throughout each cycle. These pauses are normal. Refer to “Normal Sounds” to learn more about the sounds you may hear during a wash cycle.
- Refer to “Understanding Washer Cycles” to learn what happens during a wash cycle.

NOTE: Use the full time for heavy soil and sturdy fabrics. For light soil and delicate fabrics, use less time.

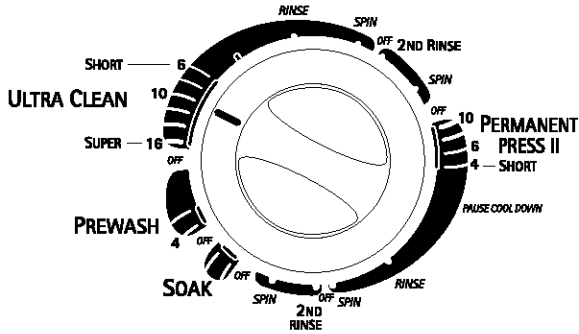

Cycle Selector Control (Timer) knob

Permanent Press II cycle

This cycle includes a load-cooling process that reduces wrinkling compared to other cycles. Select up to 10 minutes of wash time.

NOTE: When the timer reaches Pause, the washer will drain and pause for no more than 2 minutes while some of the wash water is drained and replaced with rinse water.

Ultra Clean cycle

Use this cycle for most loads to get between 6 and 16 minutes of wash time.

Prewash cycle

Use this cycle to get up to 4 minutes of agitation to help remove heavy soils and stains that need pretreatment. Prewash cycle should be followed by an Ultra Clean or Permanent Press II cycle with additional detergent added.

Soak cycle

Soak cycle features 4 minutes of agitation followed by an unlimited soak time to help remove heavy soils and stains that need pretreatment. You will need to reset the washer to a Spin setting to remove water. Soak cycle should be followed by an Ultra Clean, Permanent Press II, or Prewash cycle with additional detergent.

NOTE: Hot water is not recommended for soaking. It may set some stains.

Rinse and Spin

When using extra detergent for heavily soiled clothes, or washing special-care items, you may find an extra rinse and spin needed.

1. Set the controls for Water Level, Water Temperature, Rinse Options (to One Rinse), and Speeds.
2. Push in the Cycle Selector Control (Timer) knob and turn it clockwise to any of the Rinse settings.
3. Pull out the Cycle Selector Control (Timer) knob. The washer fills to the selected water level, agitates, drains, and spins.

Drain and Spin

A drain and spin may help shorten drying times for some heavy fabrics or special-care items by removing excess water.

1. Set Rinse Options Control (to One Rinse).
2. Set Speeds Control:
 - For fast spin, use the Heavy Duty setting.
 - For slow spin, use the Delicate setting.
3. Push in the Cycle Selector Control (Timer) knob and turn it clockwise to any of the Spin settings.
4. Pull out the Cycle Selector Control (Timer) knob. The washer drains, then spins.

Understanding Washer Cycles

When the Cycle Control knob is set to a number and pulled out, the washer fills (to the selected load size) before agitation and timing start. The washer begins agitating immediately after filling; agitation occurs with the washer lid up or down.

During agitation, the agitator creates a continuous rollover action that provides a thorough cleaning of the wash load.

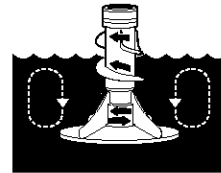

After agitation starts, the Cycle Control knob turns clockwise until it points to an OFF area and the cycle ends.

NOTE: The washer pauses briefly throughout each cycle. These pauses are normal for washer operation.

WASH	RINSE
1. Fill	1. Fill
2. Wash selected time	2. Rinse
3. Drain* No agitation	3. Drain No agitation
4. Spin	4. Spin-Spray rinse
	5. Spin
	6. Off

* The Permanent Press cycle partially drains, fills, agitates briefly, and drains.

Normal Sounds

Your new washer may make sounds your old one didn't. Because the sounds might be unfamiliar, you may be concerned about them. These sounds are normal.

During washing

When you select a small load size setting, your washer has a lower water level. This can cause a clicking sound from the upper part of the agitator.

During drain

If water is drained quickly from your washer (depending on your installation), you may hear air being pulled through the pump during the end of draining.

After drain and before spin

When the cycle changes from draining to spinning, you may hear gears engaging.

LAUNDRY TIPS

Preparing clothes for washing

Follow these recommendations to help you prolong the life of your garments.

- Close zippers, snaps, and hooks to avoid snagging other items. Remove pins, buckles, and other hard objects to avoid scratching the washer interior. Remove non-washable trim and ornaments.
- Empty pockets and turn them inside-out.
- Turn down cuffs; brush away lint and dirt.
- Turn synthetic knits inside-out to avoid pilling.
- Tie strings and sashes so they will not tangle.
- Mend tears, loose hems, and seams.
- Treat spots and stains.
- Stained or wet garments should be washed promptly for best results.

Sorting

- Separate heavily soiled items from lightly soiled ones, even if they would normally be washed together. Separate lint-givers (towels, chenille) from lint-takers (corduroy, synthetics, permanent press). When possible, turn lint-givers inside-out.
- Separate dark colors from light colors, colorfast items from non-colorfast items.
- Sort by fabric and construction (sturdy cottons, knits, delicate items).

Unloading

- Remove clothes from washer after the cycle is completed. Metal objects such as zippers, snaps, and buckles may rust if left in the washer basket for a long period of time.

Loading

Loading suggestions (maximum size loads)

KING SIZE™ Capacity Plus Washer

Heavy Work Clothes

4 jeans	2 sweatpants
4 workpants	2 sweatshirts
4 workshirts	

Towels

10 bath towels	14 washcloths
10 hand towels	

Mixed Load

3 sheets (1 king, 2 twin)	9 T-shirts
4 pillowcases	9 shorts
3 shirts	10 handkerchiefs
3 blouses	

WASHER CARE

Cleaning Your Washer

Cleaning the exterior

Use a soft, damp cloth or sponge to wipe up any spills such as detergent or bleach. Occasionally wipe the outside of your washer to keep it looking new.

Cleaning the interior

To clean your washer interior, add 1 cup (250 mL) of chlorine bleach and 1 scoop or capful of detergent into your dispenser, and run the washer through the Normal cycle using hot water. Repeat this process if necessary.

NOTE: Remove any hard water deposits using only cleaners labeled as washer safe.

Water Inlet Hoses

Replace inlet hoses after five years of use to reduce the risk of hose failure. Periodically inspect and replace inlet hoses if bulges, kinks, cuts, wear or leaks are found.

When replacing your inlet hoses, mark the date of replacement on the label with a permanent marker.

Vacation, Storage, and Moving Care

Install and store your washer where it will not freeze. Because some water may stay in the hoses, freezing can damage your washer. If storing or moving your washer during freezing weather, winterize it.

Non-use or vacation care:

Operate your washer only when you are at home. If you will be on vacation or not using your washer for an extended period of time, you should:

- Unplug washer or disconnect power.
- Turn off the water supply to the washer. This helps avoid accidental flooding (due to a water pressure surge) while you are away.

To winterize washer:

1. Shut off both water faucets.
2. Disconnect and drain water inlet hoses.
3. Put 1 qt (1 L) of R.V.-type antifreeze in the basket.
4. Run washer on an Extended Spin cycle.
5. Unplug washer or disconnect power.

To use washer again:

1. Flush water pipes and hoses.
2. Reconnect water inlet hoses.
3. Turn on both water faucets.
4. Plug in washer or reconnect power.
5. Run the washer through any cycle with ½ the normal recommended amount of detergent to clean out the antifreeze.

To transport the washer:

1. Shut off both water faucets.
2. Disconnect and drain water inlet hoses.
3. If washer will be moved during freezing weather, put in 1 qt (1 L) of R.V.-type antifreeze in the basket. Run washer on an Extended Spin cycle.
4. Disconnect the drain from the drain system.
5. Unplug the power cord.
6. Place the inlet hoses into the basket.
7. Drape the power cord and drain hose over edge into the basket.
8. Place the expanded foam plug retained from the washer's shipping material into basket opening. Close the lid and put a piece of tape over the lid and down to the front of the washer.

Re-installing the washer

1. Follow the "Installation Instructions" to locate, level and connect the washer.
2. Run the washer through any cycle with ½ the normal recommended amount of detergent to clean out the antifreeze, if used.

TROUBLESHOOTING

First try the solutions suggested here and possibly avoid the cost of a service call...

Washer won't fill, rinse or wash

- **Does the water level seem too low, or does the washer appear to not fill completely?**
This washer uses very little water and never fills completely. Water will not be seen over the top of the wash plate.
- **Check the following:**
Is the power cord plugged into a grounded 3 prong outlet?
Is there power at the plug? Check electrical source or call electrician.
Are the hot and cold water faucets turned on?
Is the water inlet hose kinked?
Are the water inlet valve screens clogged?

Washer stops

- **Check the following:**
Is the power cord plugged into a grounded 3 prong outlet?
Are the hot and cold water faucets turned on?
Is the water inlet hose kinked?
Are the water inlet valve screens clogged?
- **Is there power at the plug?**
Check electrical source or call electrician.
- **Has a fuse blown or has the circuit breaker tripped?**
If problem continues, call electrician.
- **Are you using an extension cord?**
Do not use an extension cord.
- **Is the Cycle Selector Control (Timer) knob lined up and pulled out?**
Turn Cycle Selector Control (Timer) knob to cycle and pull out to start washer. If washer still doesn't start, push knob back in, turn slightly to the right and pull out again.
- **Is the washer overloaded?**
Wash smaller loads. See "Starting Your Washer" for maximum load size.

Washer won't drain or spin

- **Is the drain hose clogged, or the end of the drain hose more than 96 in. (244 cm) above the floor?**
See "Installation Instructions" for proper installation of drain hose.
- **Is the lid open?**
The lid must be closed during operation.
- **Is there excessive sudsing?**
Use less detergent. Follow manufacturer's directions.
- **Is your voltage low?**
Check electrical source or call electrician. Do not use an extension cord.

Washer continues to fill or drain, or the cycle seems stuck

- **Does the drain hose fit too tightly in the standpipe, or is it taped to the standpipe?**
The drain hose should be loose yet fit securely. Do not seal the drain hose with tape. The hose needs an air gap. (See “Installation Instructions.”)

Washer makes noise

- **Is the load balanced and the washer level?**
The wash load should be balanced. See “Starting Your Washer” for maximum load size.

The washer must be level. The front feet should be properly installed and the nuts tightened. Reset the rear leveling legs if needed. (See “Installation Instructions.”)

Are the self-adjusting rear feet installed?

Can you hear water spraying? This is part of the wash action.

If water is drained quickly from the washer, you may hear air being pulled through the pump. This happens during the end of draining. It is normal.

When the cycle changes from washing to draining or spinning, you may hear a noise as the drive system shifts. This is normal.
- **Are you washing items with metal snaps, buckles or zippers?**
You may hear metal items touching the basket. This is normal.
- **Are you washing a small load?**
You will hear more splashing sounds when washing small loads. This is normal.
- **Is the washer installed on a solid floor?**
Refer to the “Installation Instructions” for flooring requirements.

Washer leaks

- **Check the following:**
Are the fill hoses tight? Are the fill hose washers properly seated? Is the drain hose clamp properly installed? (See “Installation Instructions.”)
- **Is the sink or drain clogged?**
Sink, floor drain and standpipe must be able to handle 17 gal. (64 L) of water per minute.
- **Is water bouncing off the tub ring or the load?**
The wash load should be balanced and not overloaded. If not, the fill or spray rinses can bounce off the load.

The washer must be level. The front and rear feet should be properly installed and the nuts tightened. Reset the self-adjusting rear feet if needed. (See “Installation Instructions.”)
- **Did you pull the drain hose from the washer cabinet and install it in a standpipe or laundry tub?**
(See “Installation Instructions.”)
- **Check household plumbing for leaks.**

Washer basket is crooked

- **Is the load balanced and the washer level?**
The wash load should be balanced.

The washer must be level. The front feet should be properly installed and the nuts tightened. Reset the rear leveling legs, if needed. (See “Installation Instructions.”)

Dispensers clogged or leaking

- **Are the laundry products in the correct dispenser?**
Add the correct amounts of chlorine bleach or fabric softener to the correct dispenser. Use only liquid chlorine bleach in the bleach dispenser.

Load too wet

- **Did you use the right cycle for the load being washed?**
Select a control setting with a higher spin speed.
- **Did you use a cold rinse?**
Cold rinses leave loads wetter than warm rinses. This is normal.

Residue or lint on load

- **Did you add detergent to the dispenser?**
For best results, use the dispenser to dissolve the detergent.
- **Did you sort properly?**
Sort lint givers (towels, chenille) from lint takers (corduroy, synthetics). Also sort by color.
- **Did you overload the washer?**
The wash load must be balanced. See “Starting Your Washer” for maximum load size. Lint can be trapped in the load if overloaded. Wash smaller loads.
- **Was paper or tissue left in pockets?**
- **Did you use enough detergent?**
Follow manufacturer’s directions. Use enough detergent to hold the lint in the water.
- **Is your water colder than 70°F (21°C)?**
Wash water colder than 70°F (21°C) may not completely dissolve the detergent.
- **Are you using a gentle wash cycle?**
Consider using liquid detergent for slow speed cycles such as Handwash, Casual or Delicate.

Stains on load

- **Did you use enough detergent?**
Use enough detergent to remove soil and hold it in suspension. Add the manufacturer's recommended amounts.
- **Did you add fabric softener directly to the load?**
Use your fabric softener dispenser. Do not drip fabric softener on clothes.
- **Is there above average iron (rust) in water?**
You may need to install an iron filter.
- **Did you properly sort the load?**
Sort dark clothes from whites and lights.
- **Did you unload the washer promptly?**
To avoid dye transfer, unload the washer as soon as it stops.
- **Did you use a fabric softener dispensing ball?**
Use the fabric softener dispenser provided with the washer. Dispensing balls will not operate correctly with this washer.
- **Did you use powder detergent in a low speed cycle?**
Consider using liquid detergent.
- **Did you add detergent, chlorine bleach or fabric softener too late in the cycle?**
Add detergent to your washer before loading the clothes. Chlorine bleach and fabric softener should be added to the dispensers before starting the washer.

Load is wrinkled

- **Did you unload the washer promptly?**
Unload the washer as soon as it stops.
- **Did you use the right cycle for the load being washed?**
Use the Delicate cycle or another cycle with a low spin speed to reduce wrinkling.
- **Did you overload the washer?**
The wash load must be balanced and not overloaded. Loads should move freely during washing.
- **Are the hot and cold water hoses reversed?**
Check to be sure the hot and cold water hoses are connected to the right faucets. (See "Installation Instructions.")

Load is tangled or twisted

- **Did you overload the washer?**
See "Starting Your Washer" for maximum load size. Loads should move freely during washing.

Gray whites, dingy colors

- **Did you properly sort the load?**
Dye transfer can occur when mixing whites and colors in a load. Sort dark fabrics from whites and lights.
- **Was the wash temperature too low?**
Use hot or warm washes if safe for the load. Hot water should be at least 111°F (44°C) to clean heavy soils.
- **Did you use enough detergent, or do you have hard water?**
Use more detergent for washing heavy soils in cold or hard water. Water temperature should be at least 70°F (21°C) for soap to dissolve and work properly.

Garment damage

- **Check the following:**
 - Were sharp items removed from pockets before washing? Empty pockets, zip zippers, snap or hook fasteners before washing.
 - Were strings and sashes tied to prevent tangling?
 - Were items damaged before washing? Mend rips and broken threads in seams before washing.
- **Did you overload the washer?**
See "Loading" for maximum load size.
- **Did you properly add chlorine bleach?**
Do not pour chlorine bleach directly on load. Use your liquid chlorine bleach dispenser. Wipe up bleach spills. Undiluted bleach will damage fabrics. Do not place load items on top of the bleach dispenser when loading and unloading the washer.
- **Did you follow the manufacturer's care label instructions?**

Wash temperature is not what I selected

- **Are the hot and cold water inlet hoses reversed?**
As washing progresses, the wash temperature will decrease slightly for hot and warm washes. This is normal.

Notes

Get it fixed, at your home or ours!

Your Home

For repair—in your home—of all major brand appliances, lawn and garden equipment, or heating and cooling systems, **no matter who made it, no matter who sold it!**

For the replacement parts, accessories and owner's manuals that you need to do-it-yourself.

For Sears professional installation of home appliances and items like garage door openers and water heaters.

1-800-4-MY-HOME® (1-800-469-4663)

Call anytime, day or night (U.S.A. and Canada)

www.sears.com www.sears.ca

Our Home

For repair of carry-in items like vacuums, lawn equipment, and electronics, call or go on-line for the location of your nearest **Sears Parts & Repair Center.**

1-800-488-1222

Call anytime, day or night (U.S.A. only)

www.sears.com

To purchase a protection agreement on a product serviced by Sears:

1-800-827-6655 (U.S.A.)

1-800-361-6665 (Canada)

Para pedir servicio de reparación a domicilio, y para ordenar piezas:

1-888-SU-HOGARSM

(1-888-784-6427)

Au Canada pour service en français:

1-800-LE-FOYER^{MC}

(1-800-533-6937)

www.sears.ca

SEARS