

hermitlux

Tabletop Dishwasher

Manual

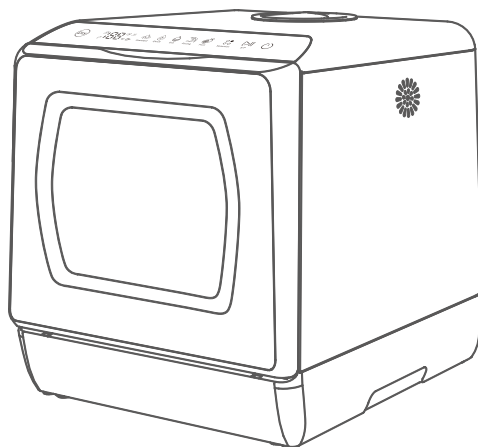

Please read the manual carefully. It contains important information on how to install, use and maintain the machine. Please retain all documents for subsequent use or for next owner.

LIST

Model No.: HMX-DW03

Safety and Warning	02
Product Introduction	03
Control Panel	04
Installation	05
Tableware Display	07
Operation	08
Functions	10
Maintain & Clean	11
Fault & Problem	12
Specification	16
RoHs Requirement	17

IMPORTANT SAFETY INSTRUCTIONS

WARNING When using your dishwasher, follow basic precautions, including the following:

- a) Read all instructions before using the dishwasher.
- b) Use the dishwasher only for its intended function.
- c) Use only detergents or wetting agents recommended for use in a dishwasher and keep them out of the reach of children.
- d) When loading items to be washed:
 - 1) Locate sharp items so that they are not likely to damage the door seal;
 - 2) Load sharp knives with the handles up to reduce the risk of cut-type injuries.
- e) Do not wash plastic items unless they are marked "dishwasher safe" or the equivalent. For plastic items not so marked, check the manufacturer's recommendations.
- f) Do not touch the heating element during or immediately after use.
- g) Do not tamper with controls.
- h) Do not abuse, sit on, or stand on the door or dish rack of the dishwasher.
- i) To reduce the risk of injury, do not allow children to play in or on a dishwasher.
- j) Under certain conditions, hydrogen gas may be produced in a hot-water system that has not been used for two weeks or more. **HYDROGEN GAS IS EXPLOSIVE.** If the hot-water system has not been used for such a period, before using the dishwasher turn on all hot-water faucets and let the water flow from each for several minutes. This will release any accumulated hydrogen gas. As the gas is flammable, do not smoke or use an open flame during this time.
- k) Remove the door to the washing compartment when removing an old dishwasher from service or discarding it.
- l) **DO NOT IMMERSE IN WATER.**
- m) **HOUSEHOLD AND INDOOR USE ONLY.**
- n) It is forbidden to open the door while the appliance is working to avoid personal danger. Don't open the door when washing avoiding to hot water flying out and causing any hurts.

SAVE THESE INSTRUCTIONS

Warning

1. Power socket must be grounded, avoiding possible electric leakage or shock;
2. Don't share one socket with other appliances avoiding to fire;
3. Any new parts or power line will be changed by the service man after damages;
4. Dispose of the machine in an environmentally friendly manner under local regulations;
5. Do not place the machine in the environment under 32°F, like outside the door in cold weather;
6. Please use salt and detergent which is special for the dishwasher;
7. Don't place and use the machine on the platform which is not stable, wet, smooth, inflammable avoiding any damage;
8. Don't place and use the machine within 5.9" far from the gas stove or heater;
9. Don't place any heavy objects on the door when the door opening to avoid the machine turn over;
10. Don't splash water into the machine avoiding electric shock or fire;
11. Don't drink the left water in the machine;
12. Don't let children operate the machine independently avoiding any dangerousness.

Precaution

1. Don't open the door when washing avoiding to hot water flying out and causing any hurts;
2. Don't touch the block of the side air outlet;
3. Don't tilt or move the machine when washing;
4. The knife or others with sharp points don't face person to avoid any hurts when opening the door;
5. Please stop washing, power off, and close the tap when any faults;
6. Please check and clean the machine from time to time for the best washing effect;
7. Please fix the drain hose avoiding to the stained water outflow;
8. Don't forcibly pull power cord, drain hose, or press cutlery tray avoiding any damage;
9. Don't use a wet hand to operate the machine avoiding electric shock;
10. Children should be far from the chemical material such as salt, detergent avoiding to any hurt.

Machine

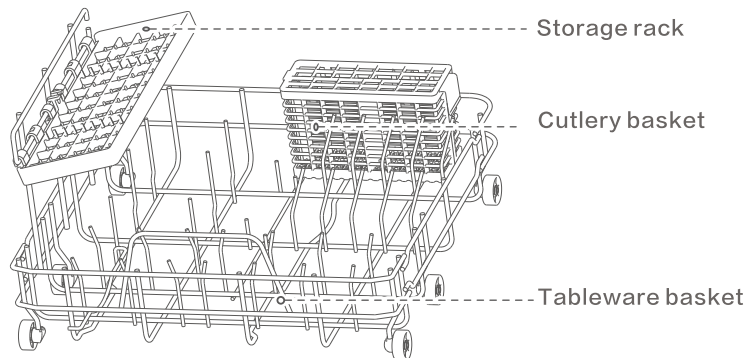
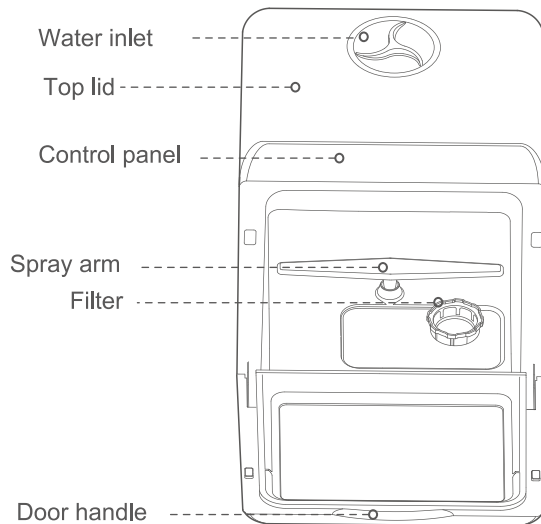

Parts list

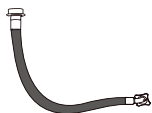

Inlet hose x1

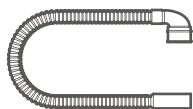

Drain hose x1

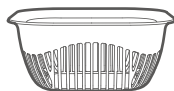

Fruit basket x1



1.8L water pitcher x1



Hose collar x1

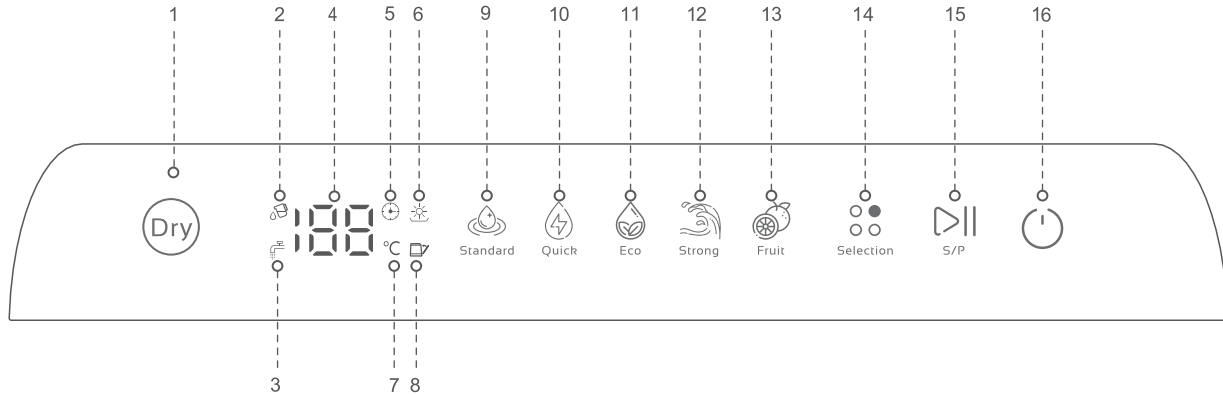

- 1.Dry
- 2.Tank model
- 3.Tap model
- 4.Display screen
- 5.Time display

- 6.Dry indicator
- 7.Temperature
- 8.Door open
- 9.Standard
- 10.Quick

- 11.ECO
- 12.Strong
- 13.Fruit
- 14.Program selection
- 15.Start/Pause
- 16.Power on/off

GROUNDING INSTRUCTIONS

This appliance must be grounded. In the event of a malfunction or breakdown, grounding will reduce the risk of electric shock by providing a path of least resistance to electric current. This appliance is equipped with a cord having an equipment-grounding conductor and a grounding plug. The plug must be plugged into an appropriate outlet that is installed and grounded in accordance with all local codes and ordinances.

WARNING - Improper connection of the equipment-grounding conductor can result in a risk of electric shock. Check with a qualified electrician or service representative if you are in doubt about whether the appliance is properly grounded. Do not modify the plug provided with the appliance, if it will not fit the outlet, have a proper outlet installed by a qualified electrician.

1. Inlet hose installation

① Connect machine

Insert the inlet hose elbow into the water inlet behind the machine and tighten the screw.

② Connect tap

A、B、C are three options for tap connection, but B and C options need to make a hole on or behind cabinet for the hose can go through the cabinet.

Note:

The product has the characteristic of heating liquid;
Water temperature does not be over 104° F if use hot water;
The size of the inlet hose elbow is 1/2' with internal thread, the tap size must be 1/2' with outer thread.

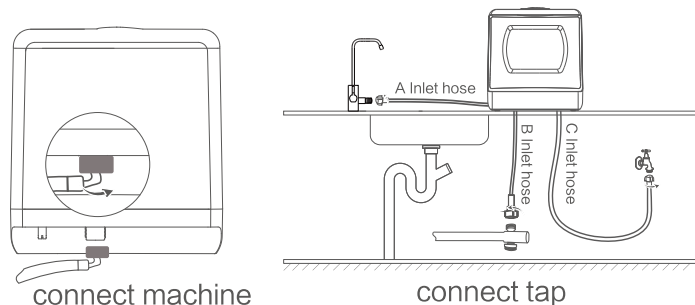

2. Drain hose installation

1 Connect machine

Insert the drain hose elbow into the water outlet behind the machine and tighten the collar.

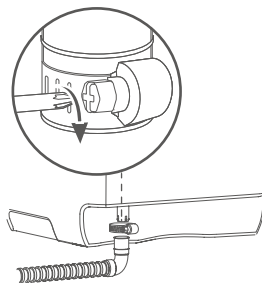

connect machine

2 Connect sewer

A、B、C are three options for sewer connection, B and C options need to make a hole on or under cabinet in order for the pipe can go through the cabinet.

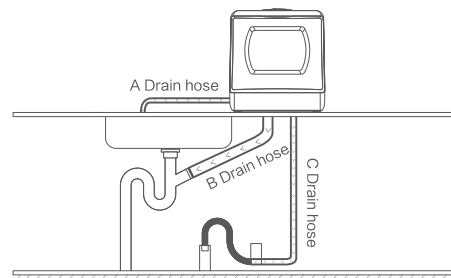

connect sewer

Note:

A hose that attaches to a sink spray can burst if it is installed on the same water line as the dishwasher. If your sink has one, it is recommended that the hose be disconnected and the hole plugged.

- 1 Please get rid of large food residue on tableware, avoiding blocking water hose.

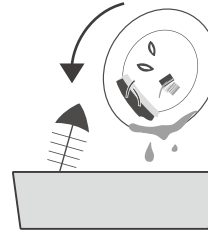

- 2 Please make reference to the right picture for tableware display.

Note:

In order to fully clean tableware, please tilt tableware internally or put stained face down;
The capacity of the maximum number of place settings is six.

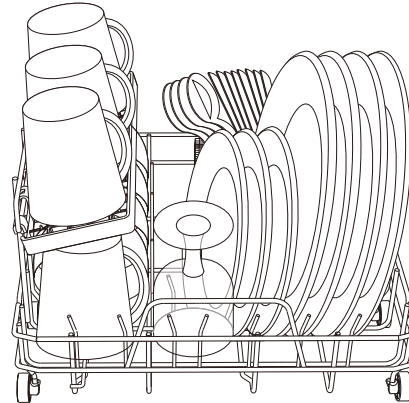

1 Power on

Plug in, touch “”, turn on the machine

Note:

Before the program finishing, hold “” for 3 seconds to force the machine to turn off.



2 Add detergent

Open the door, add moderate detergent powder, or 1pc detergent block into the machine, and close the door.

Note:

No detergent when fruit washing;
The dosage: 8-10g each washing circle.

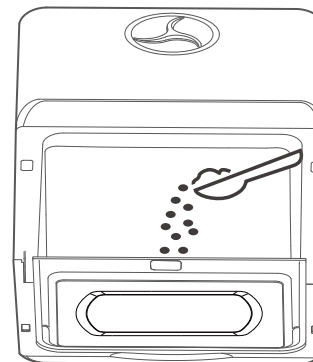

3 Program selection

Touch “”, each of the program indicators will light one by one, select the program you want.







4 Run program

Touch “”, run the selected program, the machine will check water supply automatically.





Note:

- ① The system will automatically check all supplies are appropriate, if the indicators “” “” become red, you need open the tap or fill the tank;
- ② After 5 times checking, there is still no water supply, the machine will enter standby mode;
- ③ Touch “” to force pause machine and add tableware during washing;
- ④ Touch “” for 3 seconds to quit the program, and the machine will drain, then stop;
- ⑤ Touch “Dry” to add 73 hours’ circular wind to keep air fresh inside machine.

5 Wash

The machine has two water supply models, tap model and tank model.

Note:

- ① The indicator “” is white, which means tank model;
- ② The indicator “” is white, which means tap model;
- ③ If tank is full, the machine will switch into tank model automatically;
- ④ Fill 3 cups (1.8L water pitcher) of water into tank, Di, Di, Di will be sound if the tank is full, the indicator “” will become white;
- ⑤ If the tap model, please open the water tap.

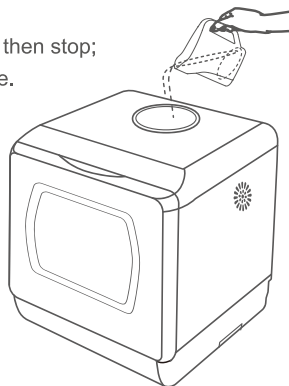

Fill water by hand
(For tank model)

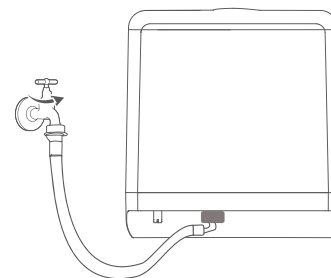

Connect tap
(For tap model)

Functions

EN

Program	Program execution	Time	Detergent	Temperature	Drying time	Storage (if selected)
Standard	Hot water washing Cold water rinsing Cold water rinsing Hot water rinsing	69Min	8g	Washing 131°F Rinsing 154°F	60Min	Circulating fresh air 73 hours
Quick	Hot water washing Cold water rinsing Hot water rinsing	29Min	8g	Washing 122°F Rinsing 144°F	60Min	Circulating fresh air 73 hours
Strong	Hot water washing Hot water rinsing Cold water rinsing Hot water rinsing	89Min	12g	Washing 131°F Rinsing 131°F Rinsing 167°F	60Min	Circulating fresh air 73 hours
ECO	Hot water washing Cold water rinsing Hot water rinsing	59Min	8g	Washing 131°F Rinsing 154°F	60Min	Circulating fresh air 73 hours
Fruit	Cold water rinsing Cold water rinsing	19Min	/	/	/	/
Dry	/	/	/	/	60Min	Circulating fresh air 73 hours

Maintain & Clean

EN

1. Clean Filter

① Disassemble

Rotate anti-clockwise to disassemble the filter set, which have 3 parts, filter mesh, main filter and fine filter.

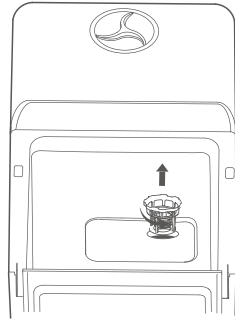

② Clean

Use water to flush and brush each of the filter parts.

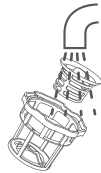

③ Assemble

After cleaning, rotated clockwise to close the filter set.

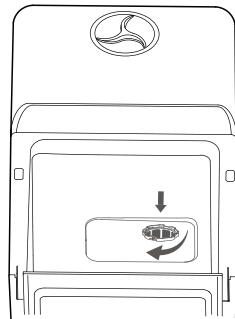

2. Clean spray arms

① Disassemble

Open the door, take out the basket, then pull out the up and down spray arms.

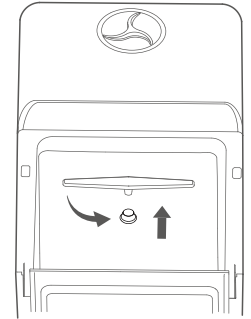

② Clean

Use water to flush and brush each spray arm, use tools with sharp points, like needle to clean holes if needed.

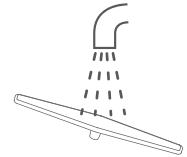

③ Assemble

After cleaning, please press each arms into position, make sure the arm can move smoothly.

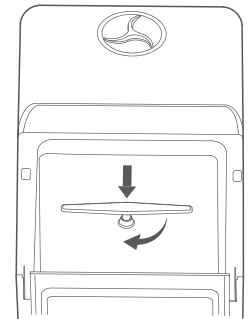

1.Fault codes

Code	Fault	How to deal with
"E2"	Draining	1.Check the drain pipe, be sure the pipe is straight, with no bending; 2.Power off, and check if anything blocks the filter or drain pipe; 3.Be sure all pipes are not blocked by something.
"E3"	Overflowing	Tilt the machine to 30~45 degrees, and let water flow out from the base of machine, restart the machine, if still show fault, contact our serviceman.
"E4"	Temperature	Restart the machine, if still show fault, please contact our serviceman.
"E5"	Message	
"E6"	Heating	
"E7"	Pressure	

Fault & problem

2.Problem(1)

Problem	Reason	How to deal with
Tableware is not clean	Incorrect tableware loading	Be sure enough gap between tableware
	Sparay arm trapped	Be sure nothing traps the sparay arm
	Blocked sparay arm	Clean sparay arm
	Blocked filter	Clean filter set
	Incorrect filter installation	Correctly assemble the filter set
	Incorrect program selection	Select appropriate washing program
	No detergent	Add detergent (block/powder/liquid)
Don't start the machine	Water shortage	Add water till the indicator light off
	Door does not close fully	Check the door if anything stops closing fully
Can not select program	Be washing	Re-select the program after stopping the in-progress program or wait in-progress program finishing

Fault & problem

2.Problem(2)

Faults	Reason	How to deal with
Tableware is wet	Inappropriate program	Select appropriate program
	Poor dry effect for plastic tableware	Wipe to dry by hand
	Incorrect tableware setting	Correct tableware setting in accordance
	Drying program not finish	Wait for dry program finishing
	Wooden tableware	Wipe to dry by hand
Discoloration of plastic tableware	Over high washing temperature	Select the program with a lower temperature
Detergent left	Blocked spary arm, no water flush detergent	Be sure the spary arm moves smoothly
	Detergent with poor quality	Use qualified detergent

Fault & problem

EN

2.Problem(3)

Faults	Reason	How to deal with
A mount of foam in the machine	Use incorrect detergent	1.Use special detergent for the dishwasher; 2.Open the machine, and wipe out the foam by hand; 3.Fill 2-3L water into the machine, and select any program, after 1-2min, the foam will be drained, repeat the process if needed.
Abnormal sound in the machine	Spary arm knock tableware	Correctly set the tableware
	Tableware move slightly	Fix tableware before washing
Egg custard left on the tableware	Portein solidification	Clean the tableware with egg custard by hand
Water drops left inside of machine	Drying time is not enough	Select "Dry" program

Specification

EN

Machine

Model No.:	HMX-DW03
Voltage	120V~
Hz	60Hz
Power	950W
Inlet pressure	0.03~1MPa
Water consumption	5L
Place setting	4sets
Net weight	26.46lbs
Machine size (WXDXH)	16.85x16.73x18.03(in)
Carton size (WXDXH)	18.90x20.08x20.67(in)
Dry	Hot wind

Electrical Drawing

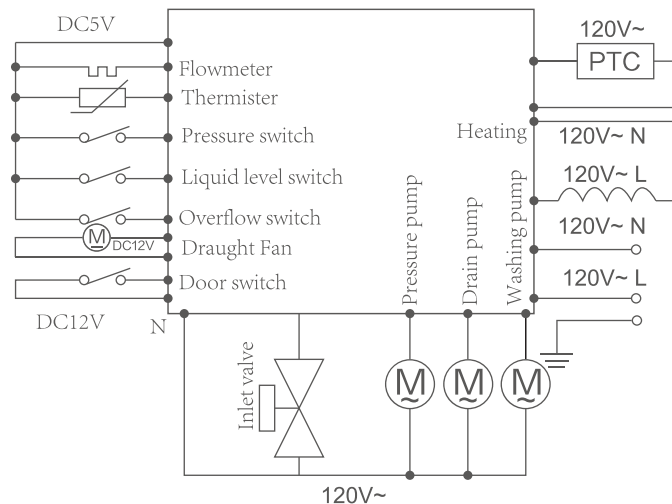

RoHS Requirement

Hazardous substances content						
Components	substances					
	Pb	Hg	Cd	Cr6+	PBB	PBDE
Plastic parts	0	0	0	0	0	0
Metal parts	0	0	0	0	0	0
Rubber parts	0	0	0	0	0	0
Screws	0	0	0	0	0	0
Stickers	0	0	0	0	0	0
Heat plate	0	0	0	0	0	0
Wire	0	0	0	0	0	0
Water pumps	0	0	0	0	0	0
PCB, Fan	X	0	0	0	0	0
Water valve	0	0	0	0	0	0
Parts of others	0	0	0	0	0	X

The table is made according to SJ/T11364 standards.

O: indicates the hazardous substance contain is below the limit of GB/T26572 standards.

X: indicate the hazardous substance contain is over the limitation of GB/T26572 standards, but fit for the RoHS order.

The information in the table is offered by suppliers, under the present skills, we will keep the best level of the hazardous substances in all of the machine parts and try our best to lower the level of the hazardous substances in the machine through improving the technologies constantly.





ZHIYUAN APPLIANCES CO., LIMITED

3/F WORKINGTON TOWER 78 BONHAMSTRAND SHEUNG WAN HK

Email: info@hermitlux.com Website: www.hermitlux.us

Warranty Card

Product

Tabletop dishwasher

Model

HMX-DW03

Sr.No.of Product

Cash memo no./
Date of Dealer

Name & Address/
Stamp of Dealer

Signature of Dealer

NOTE.

For easier reference, please present Original Sales Invoice or Official Receipt when claiming warranty.
The Manufacturer and/or Exclusive Distributor has the sole discretion in determining the cause of defects.