

Dishwasher Use & Care Manual 600 & 900 Series



Record All Information For Future Reference

Brand: _____ Purchase Date: _____

Model #: _____

Serial #: _____
(see Features page for location)

Questions? 1-800-444-4944
(United States)
1-800-661-9913
(Canada)

Visit Frigidaire Company's
Web Site at
<http://www.frigidaire.com>

Product Registration Card

Please fill in completely, sign and return promptly!



Safety

Instructions 2

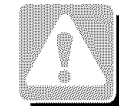

Features 3



Normal Operating

Sounds 4,6



Operating

Instructions 4-9

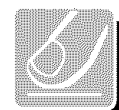

Preparing and

Loading Dishes 9-14



Dishwasher Dispenser

and Detergents 15-16



Factors Affecting

Performance 16

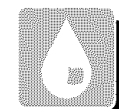

Care and

Cleaning 17

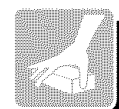

Solutions to Common

Dishwashing Problems 18-20

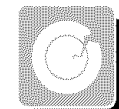

Consumer Services

Warranty & Service 21-22

Versión en español 21

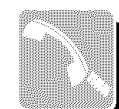



Important Safety Instructions

WARNING

This symbol will help alert you to such dangers as personal injury, burns, fire and electrical shock.

WARNING

To reduce the risk of fire, electrical shock, or injury when using your dishwasher, follow basic precautions including the following:

- Read all instructions before using your dishwasher.
 - Use your dishwasher only as instructed in this Use and Care Manual.
 - This Manual does not cover every possible condition and situation that may occur. Use common sense and caution when installing, operating and maintaining any appliance.
 - **DISHWASHER MUST BE ELECTRICALLY GROUNDED.** Read the Installation Instructions for details.
 - This dishwasher is designed to operate on regular house current (120 V, 60 Hz). Use a circuit equipped with a 15 ampere fuse or circuit breaker. Use a 20 ampere fuse if dishwasher is connected with a food waste disposer.
 - Do not operate dishwasher unless all enclosure panels are in their proper place.
 - ***Dispose of discarded appliance and shipping or packing material properly.***
 - To avoid entrapment and/or suffocation, remove door or door latch mechanism from any dishwasher that is discarded or not in use.
 - Keep young children and infants away from dishwasher when it is operating.
 - Do not let children abuse, sit, stand or play on door or racks of a dishwasher.
 - Use only detergents and rinse agents recommended for use in a dishwasher.
- Store dishwasher detergent and rinse agents out of the reach of children.
 - Do not wash plastic items unless marked “dishwasher safe” or the equivalent. Check with manufacturer for recommendations, if not marked. Items that are not dishwasher safe may melt and create a potential fire hazard.
 - If the dishwasher drains into a food disposer, make sure disposer is completely empty before running dishwasher.
 - Disconnect electrical power to dishwasher before servicing.
 - Repairs should be done by a qualified technician.
 - Do not tamper with controls.
 - Do not touch the heating element during or immediately after use.
 - When loading items to be washed:
 - Locate sharp items and knives so that they are not likely to damage the door seal or tub.
 - Load sharp items and knives with the handles up to reduce the risk of cut-type injuries.
 - Under certain conditions, hydrogen gas may be produced in a hot water system that has not been used for 2 weeks or more. **HYDROGEN GAS IS EXPLOSIVE.** If hot water system has not been used for such a period, before using dishwasher, turn on all hot water faucets and let water flow from each for several minutes. This will release any accumulated hydrogen gas. **HYDROGEN GAS IS FLAMMABLE.** Do not smoke or use an open flame during this time.
 - Do not store or use combustible materials, gasoline or other flammable vapors and liquids in the vicinity of this or any other appliance.

**SAVE THESE
INSTRUCTIONS**

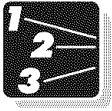

Dishwasher Features

Your dishwasher cleans by spraying a mixture of hot water and detergent through the spray arms against soiled surfaces. Each cycle begins with a pre-drain. Next, the dishwasher fills with water covering the filter area. Water is then pumped through the filter and spray arms. Soil particles go down the drain as the water is pumped out and replaced with clean water. The number of water fills will vary with the cycle being used.

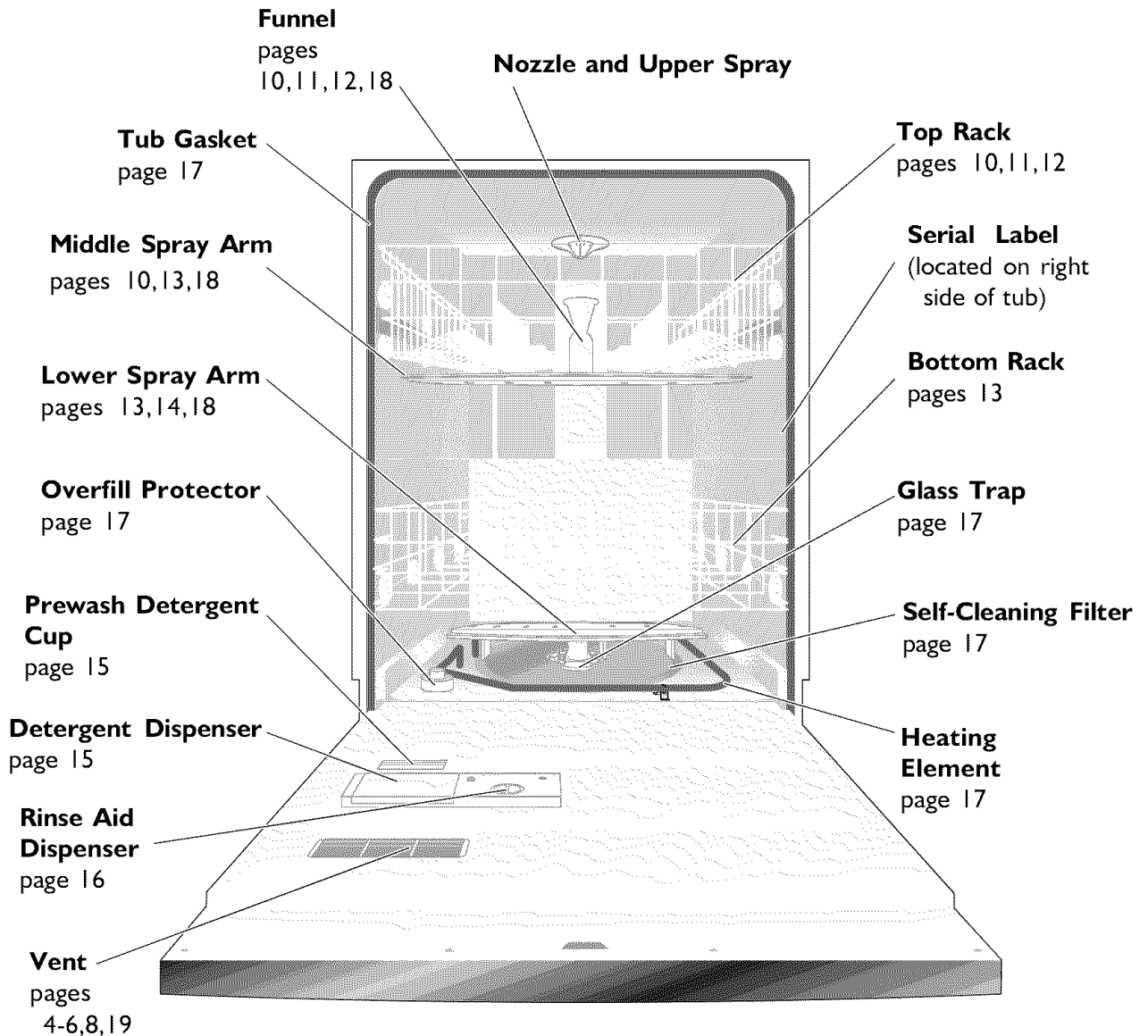



Operating Instructions

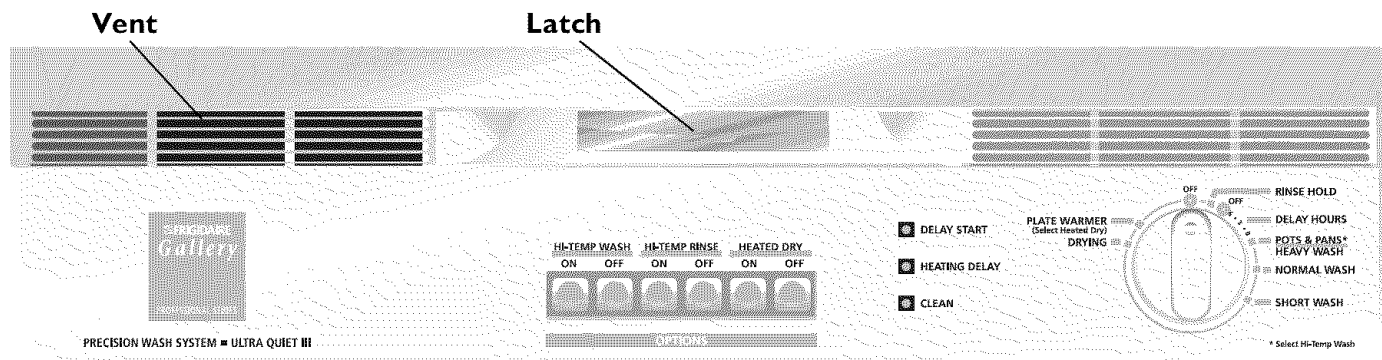

Model FDB679

Very Important Information- Read Before Operating Your Dishwasher!



Normal Operating Sounds

This dishwasher does not sound like most dishwashers—IT'S QUIETER.

The new Precision Wash System™ uses energy efficient motors for the wash and drain portions of the cycle you select. Each cycle has a series of water fills and drains for washing and rinsing dishes. As each cycle begins, you may—or may not—hear the drain motor.

The next sound you will hear is the splashing water as it enters the tub. Then the lower arm rotates and circulates water. This is followed by a pause and a slightly different sound as the middle arm sprays water. If you listen closely, you will hear the change in sound as the wash action switches from one arm to the other.

PLEASE BE ADVISED: If you compare this dishwasher to previous models, you may be surprised at what you DON'T hear!

4. Turn dial clockwise to select cycle (See Cycle Chart) or number of hours for delay start.
5. Select desired OPTIONS (See Energy Options).
6. If using DELAY START, go to step number 8.
7. Run hot water faucet nearest dishwasher until water is hot. Turn water off.
8. To start, close door to latch.

Wash Cycle Selections

Note: Cycle times are approximate and will vary with options selected. Hot water is necessary to activate dishwasher detergent and melt fatty food soils. An automatic sensor will check the incoming water temperature and, if it is not hot enough, the timer will be delayed for automatic water heating in the main wash of all cycles. This happens even when HI-TEMP WASH ON option has not been selected. When HI-TEMP WASH ON is selected, an even higher temperature will be guaranteed to handle heavier soil loads.

Delay Start

Allows you to delay starting the POTS & PANS cycle up to 6 hours.

- Turn dial to select number of hours.
- Select HI-TEMP WASH ON option and other desired options.
- Close door to latch. The DELAY START light will come on.

Plate Warmer

For warming dishes and serving plates before serving hot foods:

- Load clean plates and dishes to be warmed.
- Turn dial to PLATE WARMER.
- Select HEATED DRY ON option.

Getting Started

1. Load dishwashers (See Preparing and Loading Dishes).
2. Add detergent (See Dishwasher Dispenser & Detergents).
3. Add rinse aid, if needed (See Rinse Aid).



Operating Instructions (continued)

Cycle Chart

Cycle	Description	To Select Cycle	Water (approx.)	Time (approx.)	Washes/Rinses
Pots & Pans	For pots, pans, casseroles, and dinnerware with dried-on or baked-on soils.	<ul style="list-style-type: none"> • Turn dial to POTS & PANS/ HEAVY WASH. • Select HI-TEMP WASH ON option. • Select other desired OPTIONS. 	7.2 gal. 6.0 imp. gal. 22.7 liters	81 min.*	2 washes 4 rinses
Heavy Wash	For heavily soiled dishes and silverware.	<ul style="list-style-type: none"> • Turn dial to POTS & PANS/ HEAVY WASH. • Select desired OPTIONS. 	7.2 gal. 6.0 imp. gal. 22.7 liters	81 min.*	2 washes 4 rinses
Normal Wash	For regularly soiled dishes and silverware.	<ul style="list-style-type: none"> • Turn dial to NORMAL WASH. • Select desired OPTIONS. 	6.0 gal. 5.0 imp. gal. 22.7 liters	75 min.*	2 washes 3 rinses
Short Wash	For lightly soiled or pre-rinsed dishes and silverware.	<ul style="list-style-type: none"> • Turn dial to SHORT WASH. • Select desired OPTIONS. 	4.8 gal. 4.0 imp. gal. 18.2 liters	67 min.*	1 wash 3 rinses
Rinse/ Hold	For rinsing dishes that will be washed later.	<ul style="list-style-type: none"> • DO NOT USE detergent. • Turn dial to RINSE/HOLD. 	1.2 gal. 1.0 imp. gal. 4.5 liters	4 min.	1 rinse

* Includes dry time.

Energy Options

Hi-Temp Wash Option

When HI-TEMP WASH ON option is selected, the dishwasher heats water in main wash to approximately 140°F (60°C). Wash action will continue but timer will not advance until proper temperature is reached. The hotter water provided by this option helps activate dishwasher detergent to clean food grease and soil from dishes. HI-TEMP WASH ON option can be used with any cycle except RINSE HOLD and PLATE WARMER.

To turn off option, select HI-TEMP WASH OFF.

Hi-Temp Rinse Option

When HI-TEMP RINSE ON option is selected, the dishwasher heats water in final rinse to approximately 140°F (60°C). This will speed drying and reduce spotting. HI-TEMP RINSE ON option can be used with any cycle except RINSE HOLD and PLATE WARMER.

To turn off option, select HI-TEMP RINSE OFF.

Heated Dry Option

HEATED DRY ON option provides faster drying since the heating element is on during the drying portion of cycle.

HEATED DRY OFF option saves electricity since the heating element is off during drying

portion of cycle. With either option, a fan circulates air inside the dishwasher to speed drying. You may wish to open the door slightly after the cycle is complete since some water droplets may remain on door and tub and in areas where dishes touch silverware basket and rack.

With either option, you may see water vapor coming from vent during drying portion of cycle. The vent is closed during washing to hold moisture and sound inside and then opens for drying.

The drying option may be changed at any time during the cycle and affects only the drying period.

Status Indicator Lights

When DELAY START option is selected, the DELAY START light will glow as timer counts down to begin cycle.

The HEATING DELAY light means the cycle is being extended to heat water to proper temperature in the main wash or final rinse, based on options selected.

CLEAN light comes on when a cycle is complete. To turn it off, turn dial slightly until light goes off.





Operating Instructions (continued)

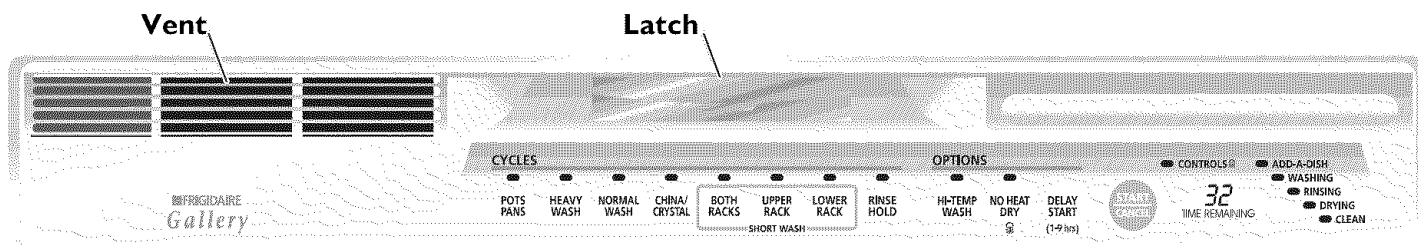

Model FDB989

Very Important Information- Read Before Operating Your Dishwasher!



Normal Operating Sounds

This dishwasher does not sound like most dishwashers—IT'S QUIETER.

The new Precision Wash System™ uses energy efficient motors for the wash and drain portions of the cycle you select. Each cycle has a series of water fills and drains for washing and rinsing dishes. As each cycle begins, you may—or may not—hear the drain motor.

The next sound you will hear is the splashing water as it enters the tub. Then the lower arm rotates and circulates water. This is followed by a pause and a slightly different sound as the middle arm sprays water. If you listen closely, you will hear the change in sound as the wash action switches from one arm to the other.

PLEASE BE ADVISED: If you compare this dishwasher to previous models, you may be surprised at what you DON'T hear!

Getting Started

1. Load dishwasher (See Preparing and Loading Dishes).
2. Add detergent (See Dishwasher Dispenser & Detergents).
3. Add rinse aid, if needed (See Rinse Aid).
4. Close door to latch.
5. Select desired CYCLE (See Cycle Chart). The indicator light above the pad will glow when selected.
6. Select desired OPTIONS (See Energy Options). The indicator light above the pad will glow when selected.
7. If using DELAY START, go to step number 9.
8. Run hot water faucet nearest dishwasher until water is hot. Turn water off.
9. To start, press START/CANCEL pad.

Wash Cycle Selections

Note: Cycle times are approximate and will vary with options selected. Hot water is necessary to activate dishwasher detergent and melt fatty food soils. An automatic sensor will check the incoming water temperature and, if it is not hot enough, the timer will be delayed for automatic water heating in the main wash of all cycles. This happens even when HI-TEMP WASH option has not been selected. When HI-TEMP WASH is selected, an even higher temperature will be guaranteed to handle heavier soil loads.



Operating Instructions (continued)

Cycle Chart					
Cycle	Description	To Start	Water (approx.)	Time (approx.)	Washes/Rinses
Pots & Pans	For pots, pans, casseroles and dinnerware with dried-on or baked-on soils.	• Select POTS PANS, HI-TEMP WASH and other desired OPTIONS.	8.4 gal. 7.0 imp. gal. 31.8 liters	106 min.*	2 washes 5 rinses
Heavy Wash	For heavily soiled dishes and silverware.	• Select HEAVY WASH and desired OPTIONS.	7.2 gal. 6.0 imp. gal. 27.3 liters	99 min.*	2 washes 4 rinses
Normal Wash	For regularly soiled dishes and silverware.	• Select NORMAL WASH and desired OPTIONS.	7.2 gal. 6.0 imp. gal. 27.3 liters	94 min.*	2 washes 4 rinses
China Crystal	For lightly soiled china and crystal.	• Select CHINA/CRYSTAL and desired OPTIONS.	6.0 gal. 5.0 imp. gal. 22.7 liters	82 min.*	1 wash 4 rinses
Short Wash (Both Racks)	For lightly soiled and pre-rinsed dishes and silverware.	• Select SHORT WASH/BOTH RACKS and desired OPTIONS.	6.0 gal. 5.0 imp. gal. 22.7 liters	82 min.*	1 wash 4 rinses
Short Wash (Upper Rack)	For lightly soiled or pre-rinsed dishes and silverware when you do not have a full load.	• Select SHORT WASH/UPPER RACK and desired OPTIONS.	3.6 gal. 3.0 imp. gal. 13.6 liters	66 min.*	1 wash 2 rinses
Short Wash (Lower Rack)	For lightly soiled dishes or pre-rinsed dishes, pots, pans and silverware when you do not have a full load.	• Select SHORT WASH/LOWER RACK and desired OPTIONS.	3.6 gal. 3.0 imp. gal. 13.6 liters	68 min.*	1 wash 2 rinses
Rinse Hold	For rinsing dishes that will be washed later.	• Select RINSE HOLD. • DO NOT USE detergent.	2.4 gal. 2.0 imp. gal. 9.1 liters	17 min.	2 rinses

* Includes dry time.

Options Selections

Hi-Temp Wash

When HI-TEMP WASH option is selected, the dishwasher heats the water in the main wash to approximately 140°F (60°C). This increase in water temperature helps dishwasher detergent remove food grease and soil from dishes more effectively and aids in drying. HI-TEMP WASH option can be used with all cycles except CHINA/CRYSTAL and RINSE HOLD.

When HI-TEMP WASH is selected, the light above the pad will come on and remain on until end of cycle. To turn off the HI-TEMP WASH option, press the pad a second time. The light above the pad will turn off.

Hi-Temp Rinse

A HI-TEMP RINSE of approximately 145°F (63°C) will automatically be provided in the final rinse on POTS PANS, HEAVY WASH, NORMAL WASH and SHORT WASH (BOTH RACKS), if HI-TEMP WASH option has been selected. This higher temperature helps speed drying and reduce spotting.





Operating Instructions (continued)

No Heat Dry

NO HEAT DRY option saves electricity since the heating element is off during drying portion of cycle. When selected, the light above the pad will come on and remain on until end of cycle. To speed the drying process, open the door slightly after the cycle is complete. Some water droplets may remain on door and tub and in areas where dishes touch silverware basket and rack.

To select heated dry, press the pad a second time. The light above the pad will turn off. Heated dry provides faster drying since the heating element is on during the drying portion of the cycle. With either option, a fan circulates the air inside the dishwasher to speed drying.

You may see water vapor coming from the vent during the drying portion of the cycle. The vent is closed during washing to hold moisture and sound inside and then opens for drying. The drying option may be changed at any time during the cycle and affects only the drying period.

Opening the door longer than one minute during the dry cycle cancels the selected dry program.

Delay Start

The DELAY START option allows you to delay starting your dishwasher up to 9 hours. Press the DELAY START pad until the desired delay time shows in the STATUS window. To cancel the DELAY START option and begin the cycle before the delay period is over, press the START/CANCEL pad.

To Cancel a Cycle

You can cancel a cycle anytime during the cycle. Press START/CANCEL pad and the dishwasher will start a 90 second drain. At the end of the drain, select the desired cycle.

Note: To start the dishwasher using the same cycle and options selected on the previous wash, just press the START/CANCEL pad.

Status Indicator Lights

When the ADD-A-DISH light is on, you can add additional items.

The WASHING light comes on at the beginning of cycle and remains on until the end of the main wash.

The RINSING light will come on and remain on during the last two rinses of all cycles.

The DRYING light indicates the drying portion of the cycle. The light will come on when either drying option is selected.

The CLEAN light will come on at end of cycle and remain on until door is opened.



Operating Instructions (continued)

Child Lock Controls

To prevent children from accidentally changing the dishwasher cycle or starting the dishwasher, lock the dishwasher controls by touching the NO HEAT DRY pad for 3 seconds. The CONTROLS light will come on and no new selections can be made until the lock is released. To unlock the controls, touch the NO HEAT DRY pad for 3 seconds until the light goes out.

Status Window

The Status window indicates the following activity:



- 1H-9H..... Number of delay start hours. The last hour will count down in minutes.
- CL..... Close dishwasher door. The status indicator lights will also flash to indicate current cycle status.
- HO..... Indicates a water heat delay.
- MINUTES..... Number of minutes left in cycle (1-99). If cycle is longer than 99 minutes, a small light will appear to the left of the first "9" and remain on until time counts below 99.
- PF..... Appears in window when dishwasher is first installed, or when power has been interrupted. HI-TEMP WASH and NO HEAT DRY indicator lights will also flash. To clear, touch START/CANCEL pad.



Preparing and Loading Dishes

Dish Preparation

Scrape away large pieces of food, bones, pits, toothpicks, etc. The continuous filtered wash system will remove remaining food particles. Burned-on foods should be loosened before loading. Empty liquids from glasses and cups.

Foods such as mustard, mayonnaise, vinegar, lemon juice and tomato based products may cause discoloration of stainless steel and plastics if allowed to sit for a long period of time. Unless the dishwasher is to be operated at once, it is best to rinse off these food soils.

- Load racks so that large items do not prevent the detergent dispenser from opening.
- Check manufacturer's recommendations before washing items in question.
- If the dishwasher drains into a food disposer, **be sure disposer is completely empty before starting dishwasher.**

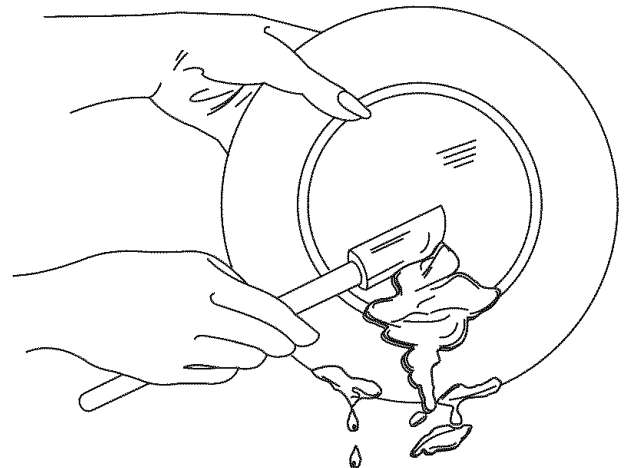

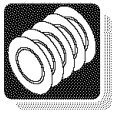

Preparing and Loading Dishes (continued)

Loading the Top Rack

Important: Do not cover the funnel when loading.

The upper rack is designed for flexibility in loading a wide variety of items including cups, glasses, stemware, small plates, bowls, etc.

Load plastic items in top rack only. Melting may occur if placed in bottom rack.

Be sure nothing protrudes through the bottom of the rack to block rotation of middle spray arm.

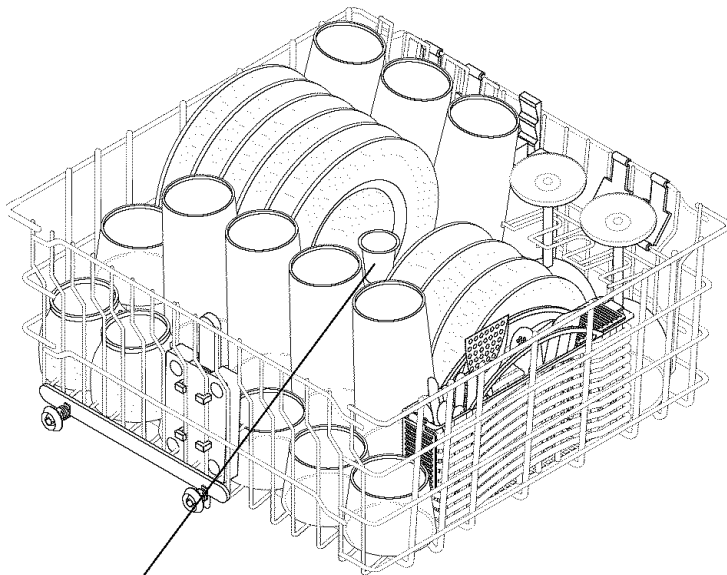

Do not cover funnel

Grabber (available select models)

The Grabber offers the ultimate in flexibility. When closed, load with saucers or small dishes. Open halfway and it is perfect for small casseroles. Open completely for those hard to fit items such as coffee pots, food processors, etc. As you load your dishwasher, you will find many other ways to use this unique feature.

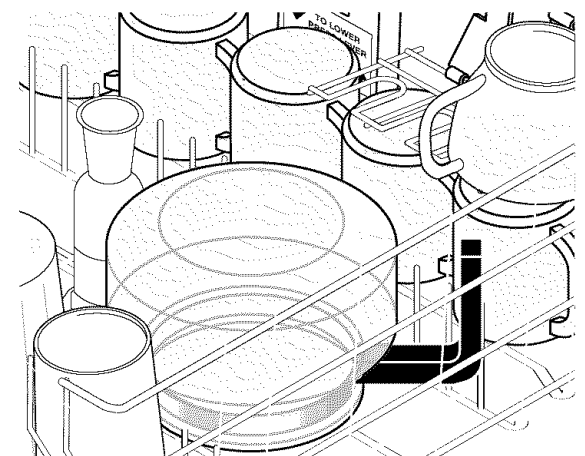
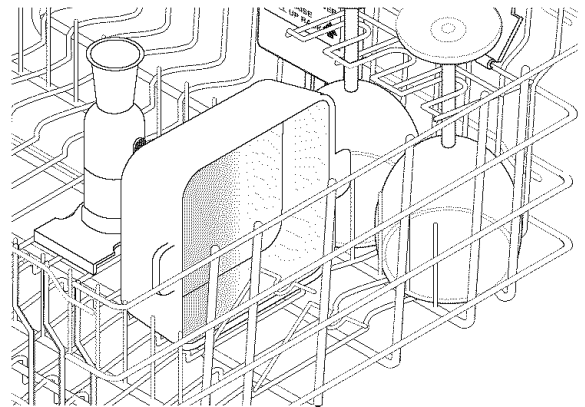
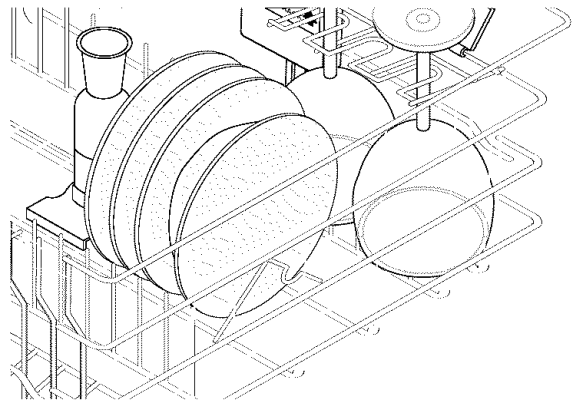

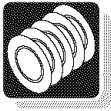

Preparing and Loading Dishes (continued)

Loading the Top Rack

(continued)

Cup Shelves/Stemware Holders (available select models)

Two split cup shelves/stemware holders handle your delicate stemware with care. They can also be used to hold two layers of cups, mugs and other short items. When using both levels, alternate items with layer below so that water can reach all inside surfaces. Fold up to load tall glasses.

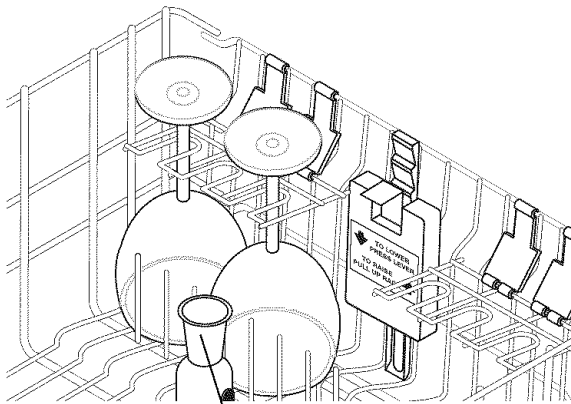

Do not cover funnel

Adjustable Mechanism (available select models)

The upper rack is adjustable and can be lowered up to 2 inches for loading taller items in upper rack. With the rack lowered, 10" plates will fit in both the upper and lower racks. Press lever on each side to lower and pull up rack to raise.

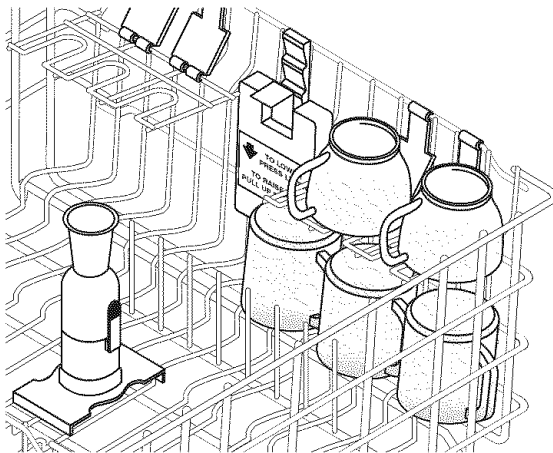
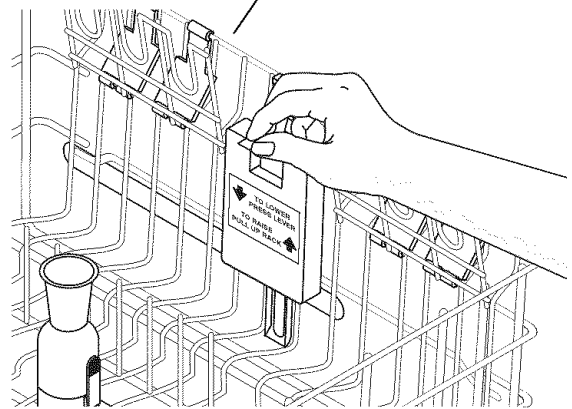
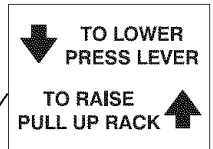

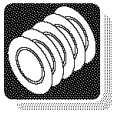

Preparing and Loading Dishes (continued)

Loading the Top Rack

(continued)

Upper Rack Option

(available select models)

SHORT WASH—UPPER RACK option can be used to wash a wide assortment of items when you don't have a full load. Also, when the upper rack fills up with glasses and the lower rack is still empty, you don't have to wait anymore for clean glasses.

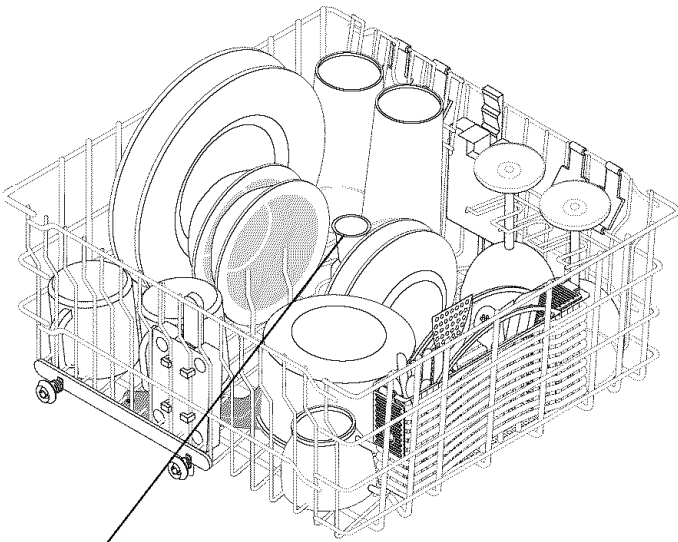

Do not cover funnel

Utility Basket

(available select models)

The utility basket has two dividers that can be opened to hold longer items or closed for small items like measuring spoons, bottle stoppers, etc. The covers on each end can be folded down out of the way or closed to keep small items inside. The utility basket also doubles as a silverware basket when using the SHORT WASH—UPPER RACK option.

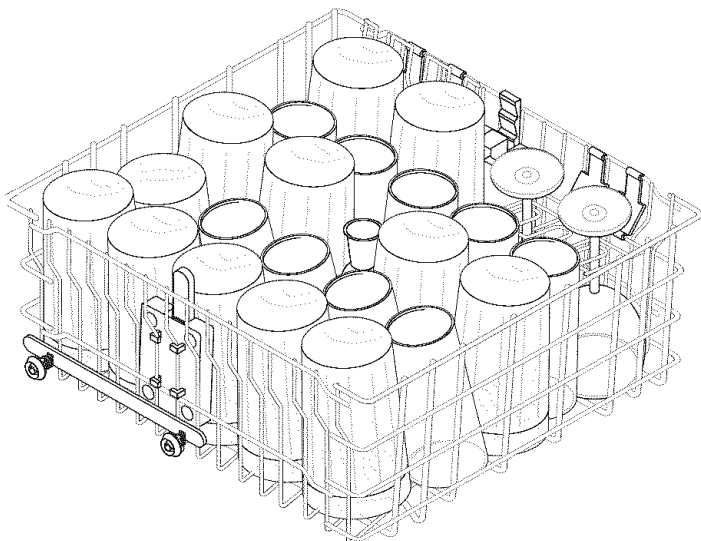
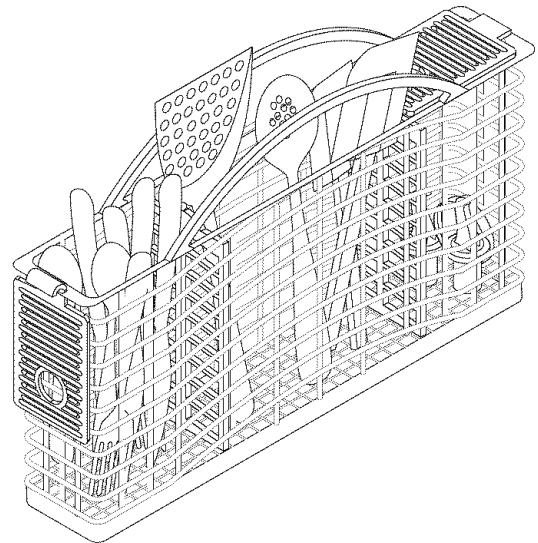



Preparing and Loading Dishes (continued)

Loading the Bottom Rack

The lower rack is best for plates, saucers, bowls and cookware. Large items should be placed along the edge so they don't block the spray arm rotation. For best results, place bowls, casseroles and sauce pans with soiled surface facing down or toward the center. Tilt slightly for better drainage.

Make sure tall items do not block spray arm rotation.

Be sure pan handles do not protrude through the bottom of the rack and block the spray arm rotation.

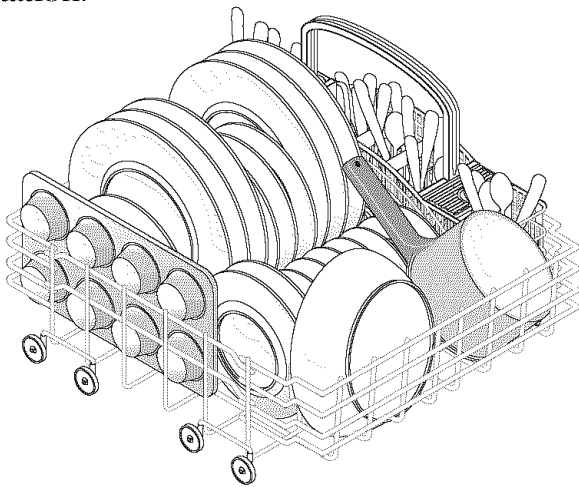

Lower Rack Option

(available select models)

SHORT WASH— LOWER RACK option can be used for lightly soiled pots and pans, large bowls, casseroles and odd shaped items when you do not have a full load. Perfect for those leftover items you usually have to wash by hand.

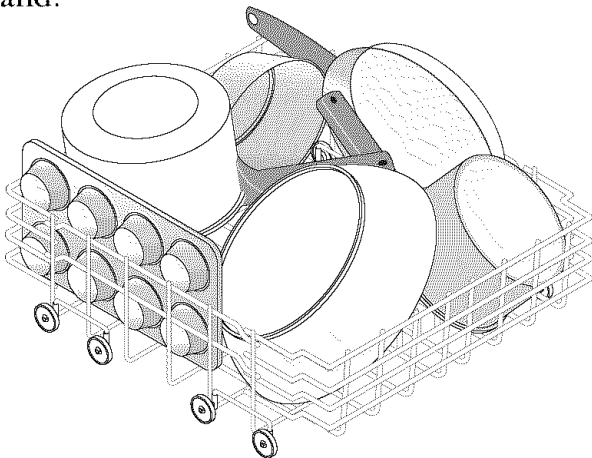

Fold-down Tines

(available select models)

The fold-down tines in the lower rack make easy loading of those extra large and hard-to-fit items. The tines may be left up for normal use or folded down for more flexible loading.

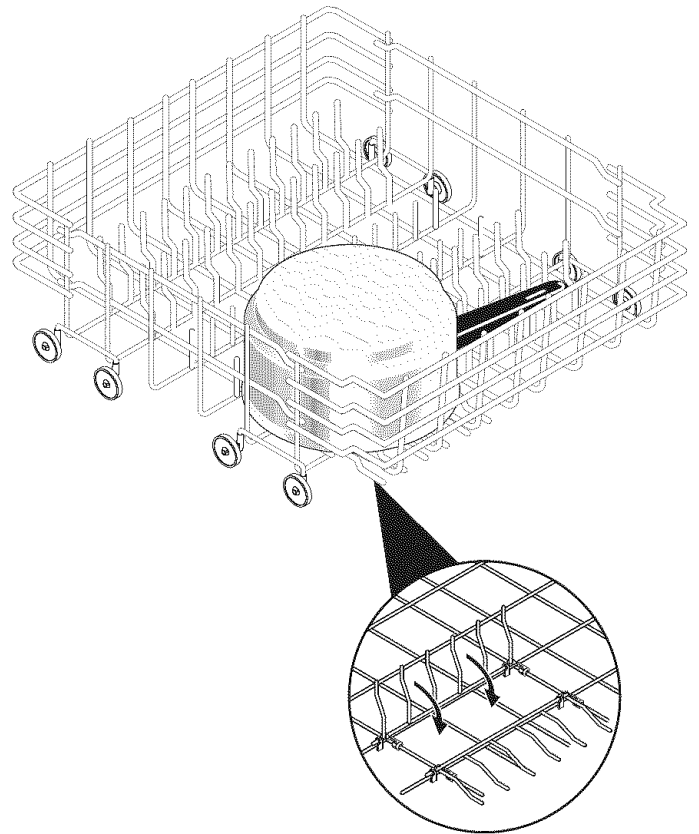



Preparing and Loading Dishes (continued)

Loading the Silverware Basket

Mix spoons, forks and knives to prevent nesting. Mixing items gives better cleaning and drying.

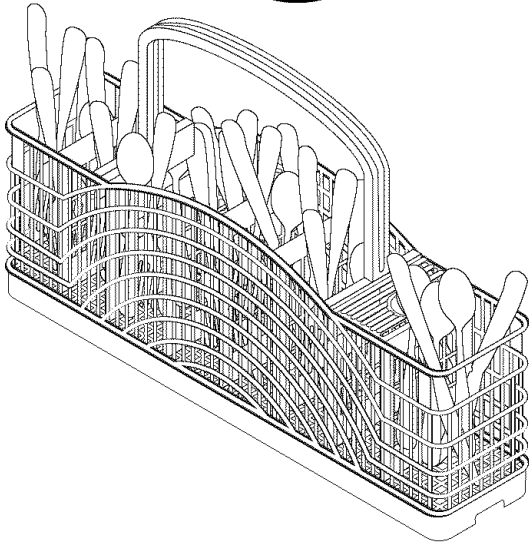
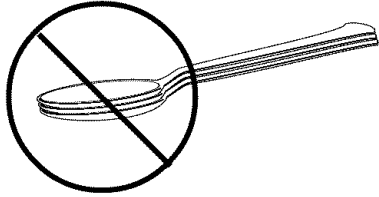

For safety, load sharp knives and forks with handles up.

Be sure nothing protrudes through bottom of basket or rack to block the spray arm.

Do not mix silver and stainless to avoid damaging the silver finish.

A covered section holds small items like measuring spoons, small plastic items, etc. Close cover to keep items in place.

Adding a Dish

To add or remove items after wash cycle starts:

- Unlatch door and wait a few seconds until wash action stops before opening.
- Add the item and wait a few seconds to allow cold air to slowly expand inside dishwasher.
- Close door firmly to latch and resume cycle. (Press START/CANCEL pad if available on your model.)

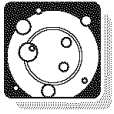

Dishwasher Dispenser & Detergents

- Use only fresh automatic dishwashing detergent. Other types will cause oversudsing.
- Add detergent just before starting cycle.
- Store detergent in a cool, dry location. Moist or caked detergent will not dissolve properly.

Filling the Detergent Dispenser

The detergent dispenser has one covered and one uncovered cup. Detergent in the uncovered cup falls into the dishwasher when the door is closed. The covered cup opens automatically in the main wash.

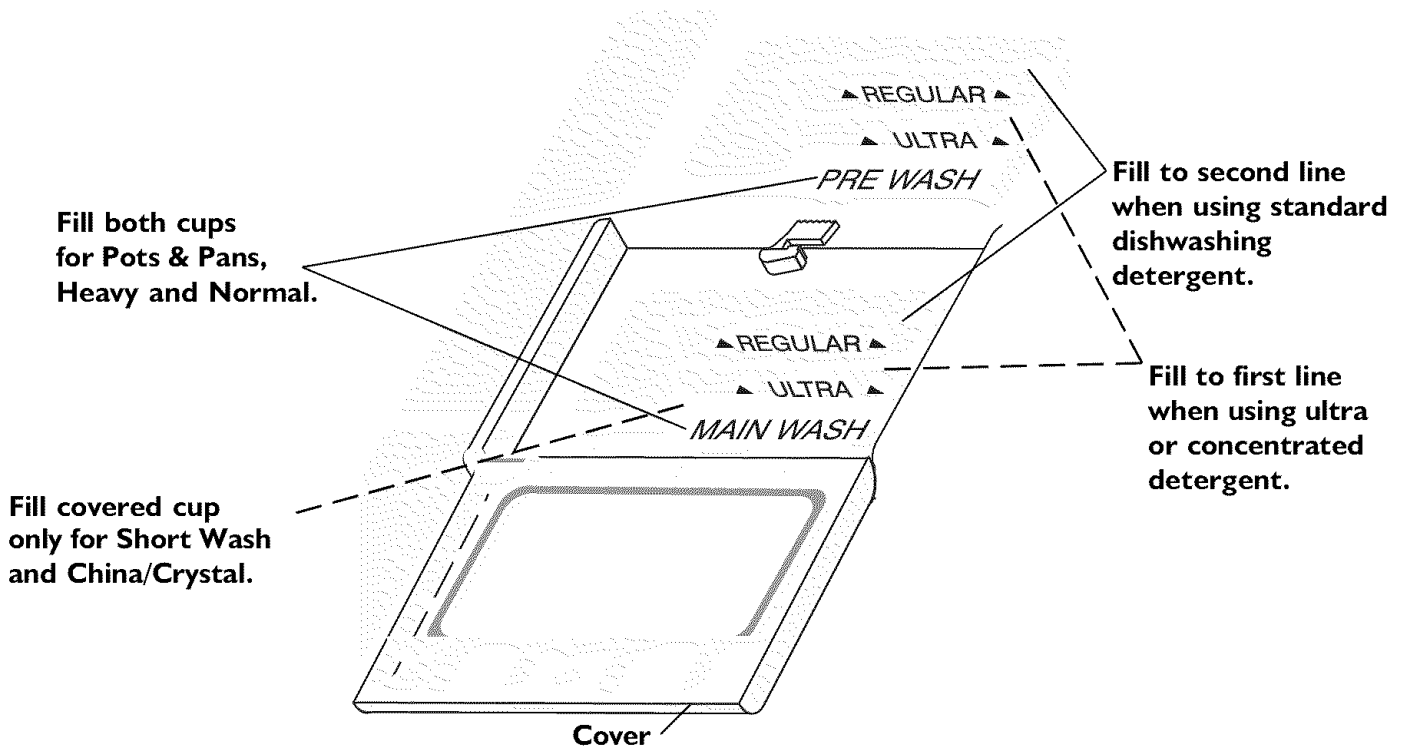

How much Detergent to use

The amount of detergent to use depends on the water hardness. Water hardness is measured in grains per gallon. Using too little detergent can result in poor cleaning and hard water filming or spotting. Using too much detergent in soft water can cause permanent etching on glassware. Your local water company, water softener company or county extension agent can tell you the water hardness in your area.

More detergent may be needed if the phosphorus content is 8.7% or less. The phosphorus content is shown on the detergent label.

Detergent Chart	
Water Hardness	Amount per Cup
Soft (0-3 grains)	2 Teaspoons
Medium (4-8 grains)	5 Teaspoons
Hard (9+ grains*)	10 Teaspoons (fill level with top)

* 12 grains and higher is extremely hard water. Detergent alone may not be enough. A water softener is recommended to improve water quality and dishwashing performance.

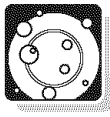

Dishwasher Dispenser & Detergents (continued)

Rinse Aid

Rinse aid greatly improves drying and reduces water spots and filming. Water “sheets” off dishes rather than forming water droplets that cling and leave spots.

A dispenser, located next to the detergent cup, automatically releases a measured amount of rinse aid during the last rinse. If spotting and poor drying are problems, increase the amount of rinse aid dispensed by rotating the dial to a higher number. The dial is located under the dispenser cap. The indicator will be dark when full and will show clear when it is time to refill.

To add liquid rinse aid, turn dispenser cap 1/4 turn counterclockwise and lift out. Pour in rinse aid until liquid touches the indicated fill level. Replace cap.

Do not overfill since this can cause oversudsing. Wipe up any spills with a damp cloth.

The dispenser holds enough for 35 to 140 washes, depending on setting.

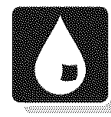

Factors Affecting Performance

Water Pressure

The hot water line to dishwasher must provide water pressure between 20 and 120 psi. Low water pressure may occur when laundry or showers are in operation. Wait until water use is reduced before starting dishwasher.

Water Temperature

Hot water is needed for best dishwashing and drying results. Water entering dishwasher should be at least 120°F (49°C) to give satisfactory results.

To check water temperature entering dishwasher:

- Turn on hot water faucet nearest dishwasher for several minutes to clear cool water from pipes.
- Hold a candy or meat thermometer in stream of water to check the temperature.
- If temperature is below 120°F (49°C), have a qualified person raise the hot water heater thermostat setting.

Important: Before starting a cycle, run hot water to clear cool water from pipe.

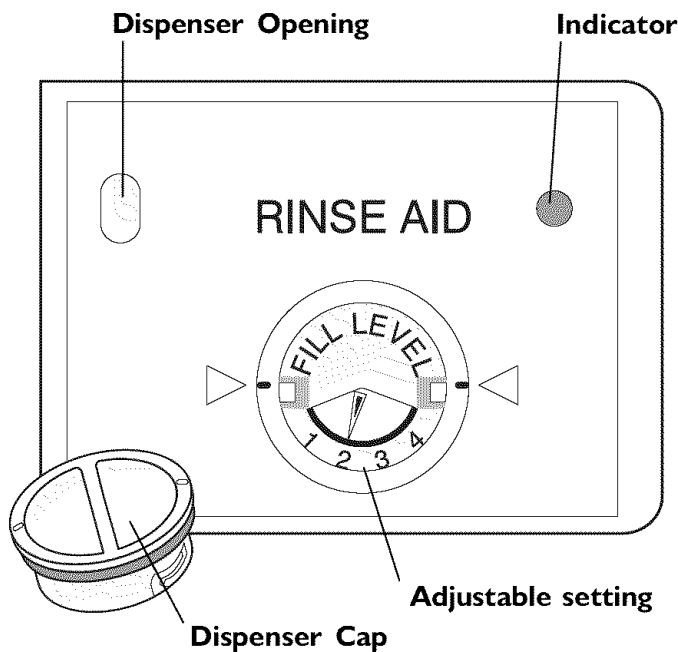



Care and Cleaning

⚠ WARNING	
	Burn Hazard
	Allow heating element to cool before cleaning the interior. Failure to do so can result in burns.

Outside—Clean stainless steel front and handle with hot soapy water and a soft dishcloth. Rinse with clean water and wipe dry with a soft cloth. Wipe stubborn spots with an ammonia-soaked paper towel, rinse and dry. Cleaners made especially for stainless steel, such as Sheila Shine, trademark of Sheila Shine, Inc., Stainless Steel Magic, trademark of Magic American Corp., or similar products are suggested. Always follow manufacturer's instructions. Clean the control panel with warm water and mild liquid detergent. Rinse well and wipe dry with a clean soft cloth. Avoid harsh or gritty cleaners or scouring pads which may scratch the finish.

Inside—The inside of the dishwasher is self-cleaning with normal use. If needed, clean around the tub gasket area with a damp cloth. The filter is self-cleaning. A glass trap located in the center of the filter is designed to collect pieces of broken glass, straws, bones and pits. To remove items in glass trap, grasp handle, lift out, empty and replace.

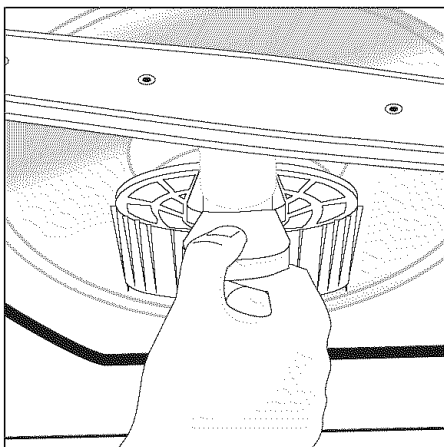

Note: Hard water may cause lime deposit buildup on the interior of the dishwasher. For cleaning instructions see “Removing Spots and Film” section.

Overfill Protector—keeps dishwasher from overflowing and is located in the left front corner of the tub.

- Clean occasionally with household cleaner containing vinegar or bleach to dissolve any buildup.
- Overfill Protector should move up and down freely about one inch. If it does not move, lift and clean underneath.

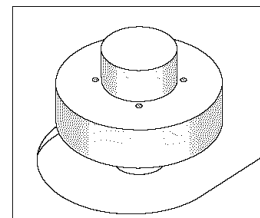

Care of Drain Air Gap

If a drain air gap was installed for your built-in dishwasher, check to make sure it is clean so the dishwasher will drain properly. A drain air gap is usually mounted on countertop and can be inspected by removing the cover. This is not part of your dishwasher and is not covered by warranty.

⚠ CAUTION	
Property Damage Hazard	
Freezing temperatures may cause water lines to rupture. Be sure all supply lines to and circulating lines within dishwasher are protected. Failure to do so could result in property damage.	



Care and Cleaning (continued)

Winterizing

A dishwasher left in an unheated place should be protected from freezing. Have a qualified person do the following:

To Disconnect Service:

1. Turn off electrical power to the dishwasher at the supply source by removing fuses or tripping circuit breaker.
2. Shut off water supply.
3. Place a pan under the inlet valve.
Disconnect water line from inlet valve and drain into pan.
4. Disconnect drain line from pump and drain water into pan.

To Restore Service:

1. Reconnect the water, drain, and electrical power supply.
2. Turn on water and electrical power supply.
3. Fill both detergent dispensers and run dishwasher through a NORMAL cycle.
4. Check connections to make sure they do not leak.

Note: See Installation Instructions for more details.



Solutions to Common Dishwashing Problems

Before calling for service, review this list. It may save you both time and expense. This list includes common experiences that are not the result of defective workmanship or material in your dishwasher.

Food Soils Left on Dishes

- Choose another cycle for longer washing time.
- Check rack loading section for proper loading—avoid nesting items.
- Home water pressure may be too low—should be 20 to 120 pounds per square inch (psi).
- Check incoming water temperature. It should be at least 120°F (49°C). (See Factors Affecting Performance.)
- Check water hardness. For extremely hard water, it may be necessary to install a water softener. (See Detergent Chart.)
- Use fresh detergent.
- Check to make sure funnel in top rack is not blocked.
- Make sure items are not blocking the spray arms, preventing them from rotating.
- Check to see if the rinse aid dispenser needs refilling.

Dishes not Dry

- Select Heat Dry option.
- Make sure the rinse aid dispenser is filled.
- Increase the amount of rinse aid. (See Rinse Aid.)
- Check the incoming water temperature. Be sure it is at least 120°F (49°C).
- Check for proper loading—avoid nesting items.
- Plastic items may need to be towel dried.
- Cups with a concave bottom will collect water.

Glassware/Flatware Spotted or Cloudy

- Check water hardness. For extremely hard water, it may be necessary to install a water softener. (See Detergent Chart.)
- Water temperature may be low. Avoid extremely low or high temperatures. (See Factors Affecting Performance.)

- Avoid overloading and improper loading. (See Preparing and Loading Dishes.)
- Use fresh detergent. Old detergent is ineffective.
- Make sure rinse aid dispenser is filled.
- Check to see that proper amount of detergent is being used for cycle selected. Also, check phosphate level. (See Detergent Dispenser.)
- Home water pressure may be too low—it should be 20 to 120 pounds per square inch (psi).

Dishware Chipped

- Load with care and do not overload. (See Preparing and Loading dishes.)
- Place delicate items in top rack.
- Place glasses securely against pins and not over pins.
- Load items so they are secure and don't jar loose when moving racks in and out. Move racks in and out slowly.
- Make sure tall glasses and stemware will clear top of tub when rack is pushed in.
- Fine antique china and crystal should be hand-washed.

Dishware Stained or Discolored

- Tea and coffee can stain cups. Remove the stains by hand washing in a solution of 1/2 cup (120 ml) bleach and one quart (1 L) of warm water. Rinse thoroughly.
- Iron deposits in water can cause a yellow or brown film. A special filter installed in the water supply line will correct this problem. (See Removing Spots and Film.)
- Aluminum utensils can leave gray/black marks when they rub against other items. Load properly.
- Certain high acid foods can cause discoloration of stainless steel and plastics if allowed to sit for a long period. Use the Rinse Hold cycle or rinse by hand if not operating dishwasher at once.
- Mixing stainless steel and silver utensils in silverware basket can cause pitting of the stainless steel blades. Avoid mixing stainless steel and silver.



Solutions to Common Dishwashing Problems (continued)

Etching

- Using too much detergent in soft or softened water causes this film that cannot be removed.
- Adjust the amount of detergent based on the water hardness. (Check Detergent Chart.)
- Lower the water temperature.
- Use No Heat Dry option.

Detergent Left in Cups

- Detergent may be old. Discard and use fresh detergent.
- Be sure water action can reach the dispenser.
- Check to see if cycle has been completed.
- Make sure items do not prevent the detergent dispenser from opening.

Dishwasher Leaks

- Use only fresh detergent designed for automatic dishwashers. Measure detergent carefully. Try a different brand.
- Spilled rinse aid can cause foam and lead to overflowing. Wipe up any spills with a damp cloth.
- Check to see that dishwasher is level. (See Installation Instructions.)

Normal Sounds You Will Hear

- Normal sounds include water fill, water circulation and motor sounds.
- There is a noticeable change in sound when the wash action switches between the lower and middle spray arm. This is normal since each spray arm has its own sound.
- It is normal for dishwasher to pause (no sound) when the wash action is switching between the lower and middle spray arms.

Water in Bottom of Tub

- Water left in bottom of tub after cycle is complete is not normal. If water remains in the bottom of the tub, dishwasher may not be draining properly. (See Dishwasher Does Not Drain Properly.)

Vapor at Vent

- Water vapor escapes from the vent when the dishwasher goes into the drying part of cycle. This is normal.

Dishwasher Won't Run

- Check to see if circuit breaker is tripped or if a fuse is blown.
- Make sure water supply is turned on.
- Check to see if cycle is set correctly. (See Operating Instructions.)
- Is dishwasher set for delay start option?
- Make sure door is closed and latched.

Dishwasher Does Not Drain Properly

- If unit is hooked up to a food waste disposer, make sure the disposer is empty.
- Check to see if the knockout plug has been removed from inside the food waste disposer inlet.
- Check to see if drain hose is kinked.
- Make sure cycle is complete, not in a pause.

Cycle Takes a Long Time

- Is cycle in a water heating delay?
- Has the delay start option been selected?

Dishwasher Won't Fill

- Is water supply turned on?
- Does overflow protector move up and down freely? (See Overflow Protector section.)

Dishwasher Has an Odor

- Soiled dishes left in dishwasher too long can create an odor. Use Rinse/Hold cycle.
- There will be a "new" smell when first installed. This is normal.
- Check to see if unit is draining properly. (See Dishwasher Does Not Drain Properly.)

Stains on Tub Interior

- Washing large amounts of dishware with tomato based soil can cause a pink/orange appearance. This will not affect performance and will gradually fade over time. Pre-rinsing or using the Rinse Hold cycle will reduce the chance of staining. Using No Heat Dry option will lessen staining.

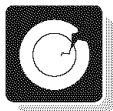

Solutions to Common Dishwashing Problems

(continued)

Removing Spots and Film

Hard water can cause lime deposit buildup on the interior of the dishwasher. Dishes and glasses may also get spots and film for a number of reasons. (See Glassware/Flatware Spotted or Cloudy section.) To remove buildup, spots and film, clean using the following instructions:

1. Load clean dishes and glasses in normal manner. Do not load any metal utensils or silverware.
2. Do not add detergent.
3. Select the HEAVY WASH cycle. Close and latch door to start. (Press START/CANCEL pad if available on your model.)
4. Allow dishwasher to run for 25 minutes to reach the main wash portion of cycle.
5. Unlatch and open door and pour 2 cups of white vinegar into the bottom of dishwasher.
6. Close and latch door and allow the cycle to finish. (Press START/CANCEL pad if available on your model.)

Note: If these conditions persist, a home water softener should be considered.



Consumer Services

Frigidaire Professional Series Gallery Dishwasher Warranty

Warrantor: Frigidaire Company, a division of White Consolidated Industries, Inc.

Covered

Full Two Year Warranty

For two years from date of purchase, Frigidaire Company will repair or replace any part of the appliance that proves to be defective in materials or workmanship.

Limited Warranty

(State of Alaska only)

All terms stated above apply except all of the technician's travel costs to the home for service and any costs for pickup and delivery of the appliance (required because of service), are excluded.

Limited 3rd-5th Year Warranty

(Electronic Controls and Nylon Racks) For models with electronic controls, provide a replacement electronic control that fails because of a manufacturing defect. For models with nylon-coated racks, provide a replacement nylon-coated rack if the original upper or lower nylon-coated rack peels or rusts because of a manufacturing defect. The consumer must pay for all labor and service charges, and the cost to ship the part(s) to the nearest authorized servicer.

Full 20 Year Warranty

(Tub and Door Liner) For twenty years from date of purchase, Frigidaire Company will provide a replacement tub or door liner if the original tub or door liner fails to contain water because of a manufacturing defect. Door seals are not included. The consumer must pay for all labor and service charges, and the cost to ship the replacement part(s) to the nearest authorized servicer.

Not Covered

1. Service calls where the problem is *not the fault* of the appliance. Examples—applicable to various appliance types but not limited to the following things:
 - a. Service calls to remove shipping devices; to level your appliance; to correct leaks at water inlet hose connections; to correct improper placement of drain hose in drain; to turn gas supply line on; to correct an improper exhaust system or to connect your appliance to your exhaust duct; to advise you on proper setting of controls or on proper use of your appliance; to correct installation of appliance; to replace owner-accessible light bulbs or fluorescent tubes.
 - b. Service calls where the problem is due to house wiring or improper voltage supply; a blown fuse or tripped circuit breaker; a slow or backed-up drain; a weak or spongy floor; insects, rodents or pests; frozen water lines in your appliance or house; improper power cord connections to appliance; blockage or restrictions in house exhaust duct or hood; appliance installed outside, exposed to elements.
2. Repairs when product is used in dwellings with multiusers (such as in community-type complexes).
3. Damage to your appliance caused by misuse, fire, flood, acts of God, or by using parts and/or service not approved by Frigidaire Company Consumer Services or an authorized Frigidaire Servicer.
4. **Consequential or incidental damages such as property damage and incidental expenses resulting from any breach of this written or any implied warranty.**
Note: Some states do not allow the exclusion or limitation of incidental or consequential damages, so this limitation or exclusion may not apply to you.
5. Expenses to make appliance accessible for servicing (for instance, removal of cabinets, cabinet doors or molding).
6. Service calls to products with serial plates that have been removed, altered, and that cannot be read well.



Keep your bill of sale, delivery slip or some other appropriate payment record. The date on the bill establishes the warranty period should service be required.

Warranty (continued)

Conditions

1. This warranty gives you specific legal rights; you may have other rights, which vary from state-to-state. We authorize no one to change or make additions to this warranty.
2. Service and installation must be provided by Frigidaire Company Consumer Services, or by an authorized Frigidaire Company Servicer. Use only genuine Frigidaire Company Consumer Parts.
3. Product features/specifications are subject to change without notice.
4. In the event a product cannot be repaired, a usage charge will be incurred.
5. The consumer must:
 - properly use and maintain appliance.
 - read and follow all warning/safety instructions in the instruction manuals and on the product.
 - read and follow all instructions in the Use & Care Manual, the Installation Instructions and on the product.
 - have product properly installed in line with all local, plumbing, electrical and/or gas codes. Appliance must be properly connected and grounded to a power supply of sufficient voltage.
 - have the product moved out of place and back into place (if moving the appliance is essential for service). If product cannot be moved by the consumer, the servicer will not be liable for damages to the floor.



For Parts and Service

Contact Frigidaire Home Products at:

800•944•9044
Frigidaire Home Products
P.O. Box 7181
Dublin, OH 43017



Versión en español

Si desea obtener una copia en español de este Manual del Usuario, sírvase escribir a la dirección que se incluye a continuación. Solicite la P/N 154285302.

Spanish Use & Care Manual
Frigidaire Home Products
P.O. Box 7181
Dublin, OH 43017-0961

Visit Frigidaire Company's Web Site at
<http://www.frigidaire.com>

Consumer Services

Dishwasher Warranty — Canada

WARRANTOR:

Frigidaire Canada
866 Langs Drive
Cambridge, Ontario
N3H 2N7

This dishwasher is a branded product of Frigidaire Canada.

WARRANTY PERIOD:

For the first 2 years after purchase by the original consumer/owner:

For the third year after purchase by the original consumer/owner:

For the third through fifth year after purchase by the original consumer/owner.

For the useful life of the dishwasher by the original consumer/owner.

WARRANTY APPLIES TO:

- Products purchased and installed in Canada for personal single family household use.
- Defects resulting or arising out of the manufacturing process.
- Products bearing legible manufacturer's model and serial numbers.
- Replacement parts only for the remainder of the original warranty.

WARRANTY DOES NOT APPLY TO:

- Transportation damage.
- Supply and replacement of porcelain, fuses, glass and light bulbs.
- Parts and service supplied or obtained from other than FRIGIDAIRE PARTS AND SERVICE or FRIGIDAIRE PARTS AND SERVICE authorized depots.
- Damage or failure as the result of abuse, improper or commercial use.

CONSUMER/OWNER RESPONSIBILITY:

- To provide proof of the original date of purchase by means of a bill of sale or payment record verifying purchase date.
- To pay all costs to make the appliance readily accessible for service.
- To ensure proper power supply and connection of the appliance to same.
- Proper installation, control setting and care of finish.

This warranty is in addition to any statutory warranties contained in any applicable legislation. The terms and conditions of this warranty are not intended to exclude or limit your rights under those statutes. The warrantor however reserves the right to charge transportation and travelling costs for distances in excess of 48 kilometres (30 miles) from the nearest FRIGIDAIRE PARTS AND SERVICE authorized service depot.

This warranty plus the statutory warranties mentioned are the only warranties given to the consumer/owner for this product.

For service under this warranty, contact your local dealer/retailer, authorized FRIGIDAIRE PARTS AND SERVICE depot, or:

FRIGIDAIRE PARTS AND SERVICE

866 Langs Drive
Cambridge, Ontario
N3H 2N7
Tel.: (519) 653-0095
Fax: (519) 653-5761

WARRANTOR WILL THROUGH ITS AUTHORIZED SERVICE DEPOT:

Pay all costs to repair or replace any defective parts.

Pay all costs (excluding labour) to repair or replace defective heating element and water distribution system including the circulation pump/motor, drain pump/motor, lower spray arm system, middle spray arm system, delivery tube system and filtration system.

For models with nylon-coated racks, provide a replacement nylon-coated rack if the original peels or rusts because of a manufacturing defect. Labour and transportation costs are excluded.

Pay all costs (excluding labour) to repair or replace a defective polypropylene tub or inner door liner arising out of the manufacturing process.