



Gas Range

User manual

NX58*665***/NX58*663***



SAMSUNG





WARNING: If the information in this manual is not followed exactly, a fire or explosion may result causing property damage, personal injury, or death.

- DO NOT store or use gasoline or other flammable vapors and liquids in the vicinity of this or any other appliance.
- WHAT TO DO IF YOU SMELL GAS:
 - DO NOT try to light any appliance.
 - DO NOT touch any electrical switch.
 - DO NOT use any phone in your building.
 - Immediately call your gas supplier from a neighbor's phone. Follow the gas supplier's instructions.
 - If you cannot reach your gas supplier, call the fire department.
- Installation and service must be performed by a qualified installer, service agency, or the gas supplier.

ANTI-TIP DEVICE

⚠ WARNING: To reduce the risk of tipping the range, the range must be secured by a properly installed Anti-Tip device. **AFTER THE RANGE HAS BEEN INSTALLED, CONFIRM THAT THE ANTI-TIP DEVICE HAS BEEN PROPERLY INSTALLED AND VERIFY THAT THE ANTI-TIP DEVICE IS PROPERLY ENGAGED.** Refer to the installation manual for instructions.

a) If the anti-tip device is not installed, a child or adult can tip the range and be killed.

- b)** Verify the anti-tip device has been properly installed and engaged at the rear right (or rear left) of the range bottom.
- c)** If you move the range and then move it back into place, ensure the anti-tip device is re-engaged at the right or left rear of the range bottom.
- d)** Do not operate the range without the anti-tip device in place and engaged.
- e)** Failure to do so can result in death or serious burns to children or adults.



⚠ WARNING

Do not step, lean, or sit on the oven door of the range. You can cause the range to tip, resulting in burns or serious injuries.

Confirm that the Anti-Tip device is installed properly. Then, to verify that the Anti-Tip device is engaged, grasp the top rear edge of the range and carefully attempt to tilt it forward. The Anti-Tip device should prevent the range from tilting forward more than a few inches.

If you pull the range out from the wall for any reason, make sure the anti-tip device is properly engaged when you push the range back against the wall. If it is not, there is a risk of the range tipping over and causing injury if you or a child stand, sit or lean on an open door.

Never completely remove the leveling legs. If you remove the leveling legs, the range will not be secured to the anti-tip device properly.





Regulatory Notice

1. FCC Notice

CAUTION

FCC CAUTION: Any changes or modifications not expressly approved by the party responsible for compliance could void the user's authority to operate the equipment.

This device complies with Part 15 of FCC Rules. Operation is Subject to following two conditions:

- 1) This device may not cause harmful interference, and
- 2) This device must accept any interference received including interference that cause undesired operation.

For products available in the US/Canadian markets, only channels 1~11 are available. You cannot select any other channels.

FCC STATEMENT:

This equipment has been tested and found to comply within the limits for a Class B digital device, pursuant to part 15 of the FCC Rules. These limits are designed to provide reasonable protection against harmful interference in a residential installation.

This equipment generates, uses, and can radiate radio frequency energy and, if not installed and used in accordance with the instructions, may cause harmful interference to radio communications. However, there is no guarantee that interference will not occur in a particular installation. If this equipment does

cause harmful interference to radio or television reception, which can be determined by turning the equipment off and on, the user is encouraged to try to correct the interference by one or more of the following measures:

- Reorienting or relocating the receiving antenna
- Increasing the separation between the equipment and receiver
- Connecting the equipment to an outlet that is on a different circuit than the radio or TV
- Consulting the dealer or an experienced radio/TV technician for help.

FCC RADIATION EXPOSURE STATEMENT:

This equipment complies with FCC radiation exposure limits set forth for an uncontrolled environment. This equipment should be installed and operated so there is at least 8 inches (20 cm) between the radiator and your body. This device and its antenna(s) must not be co-located or operated in conjunction with any other antenna or transmitter.



2. IC Notice

The term "IC" before the radio certification number only signifies that Industry Canada technical specifications were met. Operation is subject to the following two conditions: (1) this device may not cause interference, and (2) this device must accept any interference, including interference that may cause undesired operation of the device.

This Class B digital apparatus complies with Canadian ICES-003. For products available in the US/Canadian markets, only channels 1~11 are available. You cannot select any other channels.

IC RADIATION EXPOSURE STATEMENT:

This equipment complies with IC RSS-102 radiation exposure limits set forth for an uncontrolled environment. This equipment should be installed and operated so there is at least 8 inches (20 cm) between the radiator and your body. This device and its antenna(s) must not be co-located or operated in conjunction with any other antenna or transmitter.

General safety instructions

This unit has been tested and found to comply with the limits for a class B digital device, pursuant to Part 18 of the FCC rules. These limits are designed to provide reasonable protection against harmful interference in a residential installation. This unit generates, uses and can radiate radio frequency energy and, if not installed and used in accordance with the instructions, may cause harmful interference to radio communications.

However, there is no guarantee that interference will not occur in a particular installation. If this unit does cause harmful interference to radio or television reception, which can be determined by turning the unit off and on, the user is encouraged to try to correct the interference by one or more of the following measures:

- Reorienting or relocating the receiving antennae.
- Increasing the distance between the unit and receiver.
- Connecting the equipment to an outlet that is on a different circuit than the radio or TV.





Contents

Important safety information	6	Warming drawer (NX58*665*** only)	36
Overview	13	Warming drawer	36
Layout	13	Maintenance	37
What's included (NX58*665***, NX58*663***)	13	Cleaning	37
Control panel	14	Replacing the Oven Light	41
Clock	15	Oven Door: Remove and Re-Install	41
Kitchen timer	15	Warming / Storage drawer	42
Oven vent / Cooling vent	15	Troubleshooting	43
Gas range	16	Checkpoints	43
Cookware	16	Information codes	47
Center burner grate	17	Warranty (U.S.A)	47
Wok grate (NX58*665*** only)	17	Warranty (CANADA)	49
Using the griddle (NX58*665*** only)	18	Open Source Announcement (NX58*665*** only)	51
Gas burners	20		
Ignition	20		
Adjusting low flame settings on cooktop burners	21		
Gas oven	22		
Using the Oven	22		
Baking, Roasting, and Convection Cooking	22		
Broiling	23		
Using the oven racks	24		
Cooking options	26		
Slow cook, Dehydrate, Bread Proof	29		
Non-cooking functions	32		
Smart Control (NX58*665*** only)	34		



Important safety information

Read all instructions before using this appliance

- All electrical and gas equipment with moving parts can be dangerous. Please read the important safety instructions for this appliance in this manual. The instructions must be followed to minimize the risk of injury, death, or property damage.
- Save this manual. Please Do Not Discard.

Symbols used in this manual

WARNING

Hazards or unsafe practices that may result in severe personal injury or death.

CAUTION

Hazards or unsafe practices that may result in electric shock, personal injury, or property damage.

NOTE

Useful tips and instructions.

These warning icons and symbols are here to prevent injury to you and others. Please follow them explicitly. After reading this section, keep it in a safe place for future reference.

California Proposition 65 Warning

WARNING

Cancer and Reproductive Harm - www.P65Warnings.ca.gov.

Commonwealth of Massachusetts

- This product must be installed by a licensed plumber or gas fitter qualified or licensed by the State of Massachusetts. When using ball-type gas shut-off valves, you must use the T-handle type. Multiple flexible gas lines must not be connected in series.

General safety

WARNING

To reduce the risk of fire, electric shock, personal injuries, and/or death, observe the following precautions.

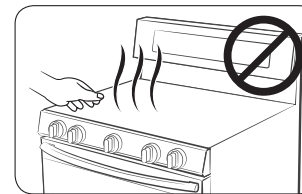

- **Do not touch** any part of the range, including but not limited to, oven burners, surface burners, or interior surfaces during or immediately after cooking.
- **Know** the location of the gas shut-off valve and how to shut it off.
- **Make sure** the anti-tip device is properly installed on the range. See the installation instructions for more information.
- **Do not let children near** the range. Do not let children go into the range or onto the range. Do not let children play with the range or any part(s) of the range. Do not leave children unattended in an area where the range is in use. For children's safety, we recommend utilizing the control/door lockout feature.
- **Remove** all packaging materials from the range before operating to prevent ignition of these materials. Keep all packaging materials out of children's reach. Properly dispose the packaging materials after the range is unpacked.





- **Do not store** any object of interest to children on the cooktop or backguard of the range. Children climbing on the range to reach items could be killed or seriously injured.
- **Do not operate** the range if the range or any part of the range is damaged, malfunctioning, or missing parts.
- **Do not use** the range as a space heater. Use the range for cooking only.
- **Do not use** oven cleaners or oven liners in or around any part of the oven.
- **Use** only dry pot holders. Pot holders with moisture in them can release steam and cause burns if they come in contact with hot surfaces. Keep pot holders away from open flames when lifting cookware. **Never use** a towel or bulky cloth in place of a pot holder.
- **Do not use** the range to heat unopened food containers.
- **Do not strike** the oven glass.
- When disposing of the range, **cut off** the power cord and **remove** the door to prevent children and animals from getting trapped.
- **Unplug** or **disconnect** power before servicing.
- **Make sure** all meat and poultry is cooked thoroughly. Meat should always be cooked to an internal temperature of 160 °F (71 °C). Poultry should always be cooked to an internal temperature of 180 °F (82 °C).
- Do not make any attempt to operate the electric ignition oven during an electrical power failure.
- Keep the appliance area clear and free of combustible materials, gasoline, and other flammable vapors and liquids.
- **Teach** children not to touch or play with the controls or any part of the range. We recommend you utilize the control / door lockout feature to reduce the risk of misuse by children.
- Do not lean on the range as you may turn the control knobs inattentively.
- Do not stand on top of the appliance or place objects (such as laundry, an oven cover, lighted candles, lighted cigarettes, dishes, chemicals, metal objects, etc.) on the appliance.
 - Items, such as a cloth, may get caught in the door.
 - This may result in electric shock, fire, problems with the product, or injury.

Fire safety

⚠ WARNING

To reduce the risk of fire, electric shock, personal injuries, and/or death, observe the following precautions.



- **Do not store, place, or use** flammable or combustible materials such as paper, plastic, pot holders, linens, curtains, gasoline or other flammable vapors or liquids near the range.
- **Do not wear** loose fitting or hanging garments while using the range.
- To avoid grease buildup, **regularly clean** the vents.
- **Do not let** pot holders or other flammable materials touch a heating element. Do not use a towel or other bulky cloths in place of a pot holder.
- **Do not use** water on a grease fire. To put out a grease fire, turn off the heat source and smother the fire with a tight-fitting lid or use a multipurpose dry chemical or foam-type fire extinguisher.
- If a grease fire should occur in the oven, **turn off the oven** by pressing the **OVEN OFF** pad. **Keep** the oven door closed until the fire goes out. If necessary, **use** a multipurpose dry chemical or foam-type **fire extinguisher**.
- **Do not heat** unopened food containers. The buildup of pressure may cause the containers to burst and result in injury.
- **NEVER use** this appliance as a space heater to heat or warm the room. Doing so may result in carbon monoxide poisoning and overheating of the oven. Do not use the oven for storage. Paper and other flammable items stored in the oven can ignite.
- **Do not** leave items such as paper, cooking utensils or food in the oven when not in use. Items stored in an oven can ignite.
- **Do not put** any combustible material or items around the range.



Important safety information

Gas safety

⚠ WARNING

To reduce the risk of fire, electric shock, personal injuries, and/or death, observe the following precautions.

If you smell gas:

- Close the valve and do not use the range.
- Do not light a match, candle, or cigarette.
- Do not turn on any gas or electric appliances.

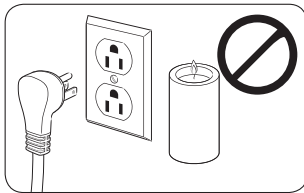

- Do not touch any electrical switches or plug a power cord into an outlet.
- Do not use any phone in your building.
- Evacuate the room, building, or area of all occupants.
- Immediately call your gas supplier from a neighbor's phone. Follow the gas supplier's instructions.
- If you cannot reach your gas supplier, call the fire department.

Checking for gas leaks

- Leak testing of the appliance must be conducted according to the manufacturer's instructions. Do not use a flame to check for gas leaks. Use a brush to spread a soapy water mixture around the area you are checking. If there is a gas leak, you will see small bubbles in the soapy water mixture at the leak point.

Electrical and grounding safety

⚠ WARNING

To reduce the risk of fire, electric shock, personal injuries, and/or death, observe the following precautions.

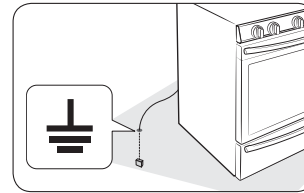

- Plug the range into a grounded 3-prong outlet.
- Do not remove the ground prong.
- Do not use an adapter or an extension cord.
- Do not use a damaged power plug, power cord, or loose power outlet.
- Do not modify the power plug, power cord, or power outlet in any way.
- Do not put a fuse in a neutral or ground circuit.
- Use a dedicated 120-volt, 60-Hz, 20-amp, AC electrical circuit with a time-delay fuse or circuit breaker for this range. Do not plug more than one appliance into this circuit.
- Do not connect the ground wire to plastic plumbing lines, gas lines, or hot water pipes.
- This range **must be Earth grounded**. In the event of a malfunction or breakdown, grounding will reduce the risk of electrical shock by providing a path for the electric current. This range is equipped with a cord having a grounding plug. The plug must be firmly plugged into an outlet that is properly installed and grounded in accordance with the local codes and ordinances. If you are unsure whether your electrical outlet is properly grounded, have it checked by a licensed electrician.
- The range is supplied with a 3-pronged grounded plug. This cord must be plugged into a mating, grounded 3-prong outlet that meets all local codes and ordinances. If codes permit the use of a separate ground wire, we recommend that a qualified electrician determine the proper path for this ground wire.
- Electrical service to the range must conform to local codes. Barring local codes, it should meet the latest ANSI/NFPA No. 70 - Latest Revision (for the U.S.) or the Canadian Electrical Code CSA C22.1 - Latest Revisions.
- It is the personal responsibility of the range owner to provide the correct electrical service for this range.





Installation safety

⚠ WARNING

To reduce the risk of fire, electric shock, personal injuries, and/or death, observe the following precautions.

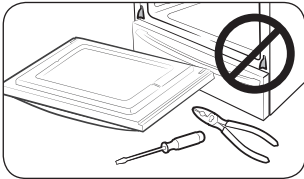

- Have your range installed and properly grounded by a **qualified installer**, in accordance with the installation instructions. Any adjustment and service should be performed only by qualified gas range installers or service technicians.
- **Do not attempt** to service, modify, or replace your range or any part of your range unless it is specifically recommended in this manual. All other service should be referred to a qualified technician.
- Always use new flexible connectors when installing a gas appliance. **Do not use** old flexible connectors.
- **Make sure** the anti-tip device is properly installed on the range. See the installation instructions for more information.
- Due to the size and weight of the range, have **two or more people** move the range.
- **Remove** all tape and packaging materials.
- **Remove** all accessories from the cooktop, oven, and/or lower drawer. Grates and griddles are heavy. Use caution when handling them.
- **Make sure** no parts came loose during shipping. Do not install in an area exposed to dripping water or outside weather conditions.
- **Make sure** your range is correctly installed and adjusted by a qualified service technician or installer for the type of gas (natural or LP) you will use. For your range to utilize LP gas, the installer must replace the 5 surface burner orifices and 2 oven orifices with the provided LP orifice set, and reverse the GPR adapter. These adjustments must be made by a qualified service technician in accordance with the manufacturer's instructions and all codes and requirements of the authority having jurisdiction. The qualified agency performing this work assumes the gas conversion responsibility.

- Installation of this range must conform with local codes or, in the absence of local codes, with the National Fuel Gas Code, ANSI Z223.1/NFPA.54, latest edition. In Canada, installation must conform with the current Natural Gas Installation Code, CAN/CGA-B149.1, or the current Propane Installation Code, CAN/CGA-B149.2, and with local codes where applicable. This range has been design-certified by ETL according to ANSI Z21.1, latest edition, and Canadian Gas Association according to CAN/CGA-1.1, latest edition.

Location safety

⚠ WARNING

To reduce the risk of fire, electric shock, personal injuries, and/or death, observe the following precautions.

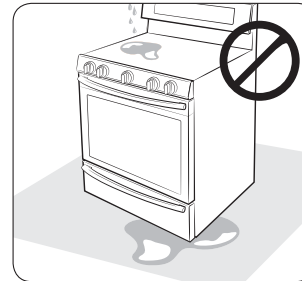

- This range is for indoor, household use only. **Do not install** the range in areas exposed to the weather and/or water.
- **Do not install** the range in a place which is exposed to a strong draft.
- Select a level, well-constructed floor that can support the range's weight. Synthetic flooring, such as linoleum, must withstand 180 °F (82 °C) temperatures without shrinking, warping, or discoloring. **Do not install** the range directly over interior kitchen carpeting unless a sheet of ¼ inch plywood or a similar insulator is placed between the range and carpeting.
- Select a location where a grounded, 3-prong outlet is easily accessible.
- If the range is located near a window, **do not hang** long curtains or paper blinds on that window.
- For the range to ventilate properly, make sure the range's vents are not blocked, and that there is enough clearance at the top, back, sides, and underneath the range. The vents allow the necessary exhaust for the range to operate properly with correct combustion.





Important safety information

- **Make sure** the wall coverings around the range can withstand heat up to 200 °F (93 °C) generated by the range.
- Cabinet storage above the surface of the range should be avoided. If cabinet storage above the range is necessary, allow a minimum clearance of 40 inches (102 cm) between the cooking surface and the bottom of the cabinets or install a range hood that projects horizontally a minimum of 5 inches (12.7 cm) beyond the bottom of the cabinets.
- **Locate** the range out of kitchen traffic paths and drafty locations to prevent poor air circulation.
- If the range is located near a window, NEVER hang long curtains or paper blinds on that window. They could blow over the surface burners and ignite, causing a fire hazard.

Cooktop safety

⚠ WARNING

To reduce the risk of fire, electric shock, personal injuries, and/or death, observe the following precautions.

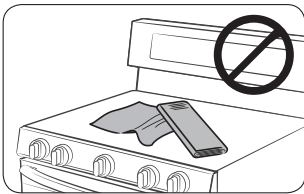

- **Make sure** all burners are off when you are not using the range.
- **Do not use** aluminium foil to line the grates or any part of the cooktop. This can cause carbon monoxide poisoning. Aluminum foil linings may also trap heat, causing a fire hazard. **Do not leave** burners unattended on medium or high heat settings.
- Before igniting the burners, **make sure** all burner caps are properly in place and all burners are level.
- **Always use** the Lite position when igniting the burners and make sure the burners have ignited. If ignition fails, turn the knob to OFF and wait until the gas has dissipated.
- When you set a burner to simmer, **do not turn** the knob quickly. Make sure the flame stays on.
- **Do not place** any objects other than cookware on the cooktop.
- This cooktop is designed for use with a wok or wok ring attachment.
- To flame food, you must have a ventilation hood. When you flame food, the hood must be on.
- Before removing or changing cookware, turn off the burners.
- Remove food and cookware immediately after cooking.
- Before removing any parts of the burner for cleaning, make sure the range is off and completely cool.
- After cleaning the burner spreader, make sure it is completely dry before re-assembling.
- **Make sure** the spark mark on the dual burner spreader is placed beside the electrode when it is assembled.
- To avoid carbon monoxide poisoning, do not pour water into the cooktop well while cleaning.
- Select cookware that is designed for range top cooking. Use cookware that is large enough to cover the burner grates. Adjust the burner flames so that the flames do not extend beyond the bottom of the cookware.
- To avoid cookware discoloration, deformity, and/or carbon monoxide poisoning, do not use cookware that is substantially larger than the grate.
- Make sure cookware handles are turned to the side or rear of the cooktop, but not over other surface burners.
- Stand away from the range while frying.
- Always heat frying oils slowly, and watch as they heat. If you are frying foods at high heat, carefully watch during the cooking process. If you are going to use a combination of fats or oils when frying, mix them together before heating.
- Use a deep-fryer thermometer whenever possible. This prevents overheating the fryer beyond the smoking point.
- Use a minimum amount of oil when shallow pan-frying or deep-frying. Avoid cooking unfrozen food or food with excessive amounts of ice.





- Before moving cookware full of fats or oils, make sure it has completely cooled.
- To prevent delayed eruptive boiling, always allow heated liquids to stand at least 20 seconds after you have turned off the burner so that the temperature in the liquid can stabilize. In the event of scalding, follow these first aid instructions:
 1. Immerse the scalded area in cool or lukewarm water for at least 10 minutes.
 2. Do not apply any creams, oils, or lotions.
 3. Cover with a clean, dry cloth.

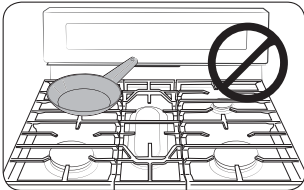

- Place pots in the center of the grate. Do not place a pot larger than 9" in diameter on the rear burners. If you place an oversized pot in the wrong position, it might disrupt necessary air circulation and make the flame on the burner sputter and burn inefficiently.

- **Do not wear** loose or hanging garments when using the range. They could ignite and burn you if they touch a surface burner.
- **Never leave** plastic items on the cooktop. Hot air from the vent can melt or ignite plastic items or cause a build up of dangerous pressure in closed plastic containers.
- **Do not place** portable appliances, or any other object other than cookware on the cooktop. Damage or fire could occur if the cooktop is hot.
- **Always make sure** foods being fried are thawed and dry. Moisture of any kind can cause hot fat to bubble up and over the sides of the pan.
- **Always make sure** the controls are OFF and the grates are cool before you remove them to prevent any possibility of being burned.
- **Do not put** any combustible material or items around the range.
- **Take care** that your hands do not touch the burners when they are on. Turn off the burners when you change a pan or pot.
- To warm liquid such as sauces, stir it while warming.

Oven safety

⚠ WARNING

To reduce the risk of fire, electric shock, personal injuries, and/or death, observe the following precautions.

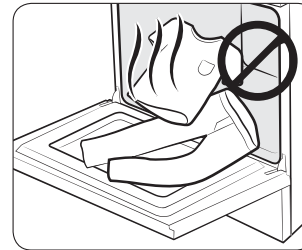

- **Do not use** the oven for non-cooking purposes such as drying clothes or storage. Use the oven for cooking only.
- **Make sure** the inner portion of the split oven-rack is in the proper position within the outer rack.
- **Make sure** the oven racks are placed on the same level on each side.
- **Do not damage, move, or clean** the door gasket.
- **Do not spray** water on the oven glass while the oven is on or just after you have turned it off.
- **Do not use** aluminium foil or foil liners anywhere in the oven. Do not use aluminium foil or similar material to cover any holes or passages in the oven bottom or to cover an oven rack. This can cause carbon monoxide poisoning. Aluminum foil linings may also trap heat, causing a fire hazard.
- Stand away from the oven when opening the oven door.
- Keep the oven free from grease buildup.
- When repositioning the oven racks, **make sure** the oven is completely cool.
- **Only use** cookware that is recommended for use in gas ovens.
- To avoid damaging the burner control knobs, always bake and/or broil with the oven door closed.
- **Do not broil** meat too close to the burner flame. Trim excess fat from meat before cooking.
- When using cooking or roasting bags in the oven, follow the manufacturer's directions.
- **NEVER cover** any slots, holes, or passages in the oven bottom or cover an entire rack with material such as aluminum foil. Doing so blocks air flow through the oven and may cause carbon monoxide poisoning. Aluminum foil linings may also trap heat, causing a fire hazard.



Important safety information

Warming drawer safety (NX58*665*** only)

⚠ WARNING

To reduce the risk of fire, electric shock, personal injuries, and/or death, observe the following precautions.



- The warming drawer is designed to keep hot foods at serving temperature. Always start with hot food. Cold or room temperature food cannot be heated, warmed, or cooked in the warming drawer. Bacteria will grow very rapidly in food that is between 40 and 140 °F.
- **Do not use** the drawer for non-cooking purposes such as drying clothes or storage. Use the drawer to keep hot food warm only.
- **Do not touch** the interior drawer surface or heating element. These surfaces may be hot and could burn you.
- To avoid steam burns, use caution when opening the drawer.
- **Do not** line the drawer with aluminium foil.
- **Do not place** the drawer in the oven. Do not put the drawer in the oven during a self-cleaning cycle.
- **Do not leave** containers of fat drippings in or near the drawer.
- **Use care** when opening the drawer. Open the drawer a crack and let hot air or steam escape before removing or replacing food. Hot air or steam which escapes can cause burns to hands, face, and/or eyes.
- **Do not use** the drawer to dry newspapers. If overheated, newspapers can catch on fire.
- **Do not** line the drawer with aluminum foil. Foil is an excellent heat insulator and will trap heat beneath it. This will upset the performance of the drawer and it could damage the interior finish.
- **Do not leave** paper products, plastics, canned food, or combustible materials in the drawer.
- **Never leave** jars or cans of fat drippings in or near the drawer.
- **Do not warm** food in the drawer for more than three hours.

Self-cleaning oven safety

⚠ WARNING

To reduce the risk of fire, electric shock, personal injuries, and/or death, observe the following precautions.

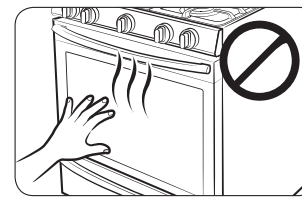

- The self-cleaning feature operates the oven at temperatures high enough to burn away food soils in the oven. The range is extremely hot during a self-cleaning cycle. **Do not touch** any surfaces of the range during a self-cleaning cycle.
- Keep children away from the oven during a self-cleaning cycle.
- Before starting a self-cleaning cycle, **remove** all racks, cookware, and utensils from the oven. Only porcelain-coated oven racks may be left in the oven.
- Before starting a self-cleaning cycle, wipe grease and food soils from the oven.
- **Do not** put the lower drawer into the oven cavity when you run a self-cleaning cycle.
- When opening the door after a self-cleaning cycle, stand away from the oven.
- If the self-cleaning cycle malfunctions, turn off the oven, disconnect the power supply, and contact a qualified service technician.





Overview

Layout

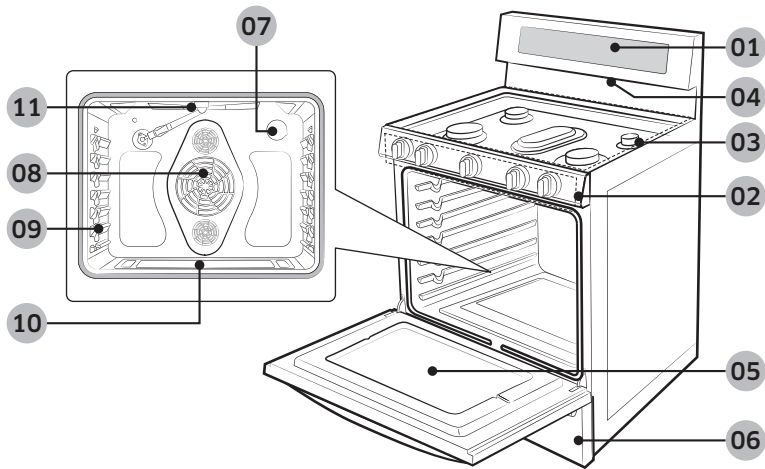

- | | | |
|----------------------------|--|----------------------------|
| 01 Display | 02 Surface burner knobs (5 pcs) | 03 Surface burners |
| 04 Oven vent | 05 Removable oven door | 06 Drawer |
| 07 Oven light * | 08 Convection fan/Convection heater | 09 Oven rack system |
| 10 Bake oven burner | 11 Broil oven burner | |

NOTE

If you need a part marked with an * (asterisk), you can buy it from the Samsung Contact Center (1-800-726-7864).

What's included (NX58*665***, NX58*663***)

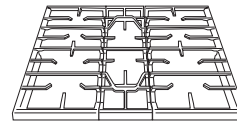

Surface burner grates (3) *

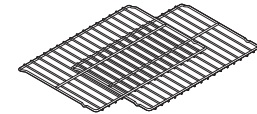

Flat rack (2) *



Surface burners and caps (5 sets) *
(NX58*663*** only)



Surface burners and caps (5 sets) *
(NX58*665*** only)

What's included (NX58*665*** only)

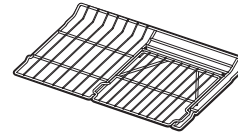

Split rack (1) *



Steam tray (1)

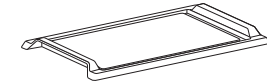

Griddle (1)



Wok grate (1)

NOTE

If you need an accessory marked with an * (asterisk), please contact the Samsung Call Center at 1-800-726-7864 or visit our on-line parts web site at www.samsungparts.com.



Overview

Control panel

NX58*665***

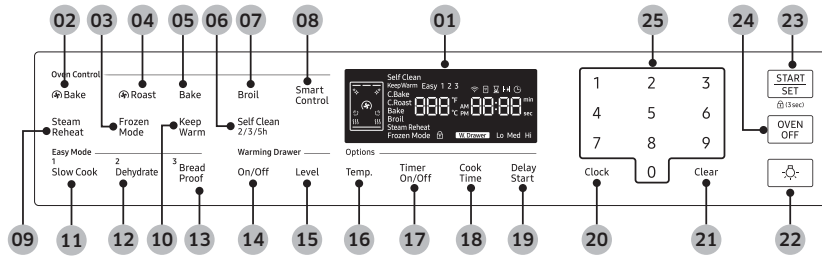

NX58*663***

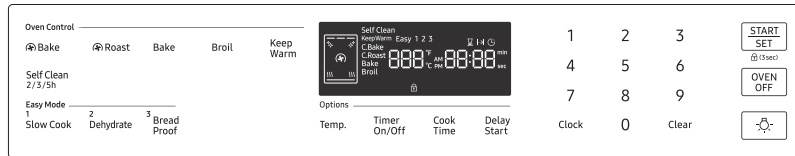

01 Display: Shows the time of day, oven temperature, whether the oven is in the bake, broil, or self-cleaning mode, and the time set for timer or automatic oven operations.

- ✦ : When you use the self-cleaning feature, this icon appears in the display.
- ⏸ : When the oven is pre-heating, this icon appears in the display.

- 02 Bake (Convection Bake):** Activates convection baking.
- 03 Frozen Mode:** Activates the cooking mode for frozen foods. (NX58*665*** only)
- 04 Roast (Convection Roast):** Activates convection roasting.
- 05 Bake:** Activates standard baking.
- 06 Self Clean:** Burn off food residues in the oven using very high temperatures.
- 07 Broil:** Activates the broiler.

08 Smart Control: Activates the Easy-connection. (NX58*665*** only)

- 📶 : When you use the Easy connection, this icon appears in the display.
- 📶 : When the oven is connected to Wifi, this icon appears in the display.

09 Steam Reheat: Activates the steam reheating feature. (NX58*665*** only)

10 Keep Warm: Keep cooked food warm at lower temperatures.

11 Slow Cook: Activates Slow Cook which cooks food slowly at lower temperatures.

12 Dehydrate: Activates the Dehydrate function.

13 Bread Proof: Activates the Bread proof function.

14 On/Off: Turn on or turn off the warming drawer. (NX58*665*** only)

15 Level: Determine warming temperature level. (NX58*665*** only)

16 Temp.: Change cooking temperature of the oven.

17 Timer On/Off: Activates or deactivates the timer.

18 Cook Time: Set the cooking time.

19 Delay Start: Set the oven to start at a certain time.

20 Clock: Set the clock time.

21 Clear: Clear the numbers just inputted.

22 Oven Light: Turn on/Turn off the oven light.

23 START/SET: Start a function or set the time.

- 🔒 (3sec): Press and hold for 3 seconds to lock the control panel and the door to prevent accidents.

24 OVEN OFF: Cancel oven operation.

25 Numbers: Use to set the times, temperature, or presets.



Clock

You must set the clock correctly to ensure the automatic features work properly. This product supports two time formats: 12-hour (default) and 24-hour.

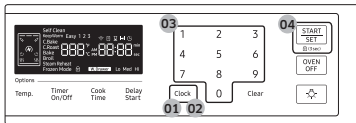

To set the clock time

1. Press the **Clock** pad.
2. Set AM or PM by pressing the **Clock** pad. Press the **START/SET** pad for the next step.
3. Enter the current time by pressing the number pad. If the value is wrong, press **Clear** to return to Step 2. If the value is correct, press the **START/SET** pad.
4. Press the **START/SET** pad to confirm the settings.
5. When the Cooking time, Delay start, or Timer feature is in use, press the **Clock** pad to display the current time.

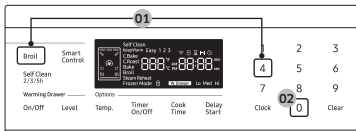

To change the time format (12hr/24hr)

1. Press and hold the **Broil** and **4** pads simultaneously for 3 sec.
2. Press the **0** Pad to toggle between the 12-hour and 24-hour display setting.
3. Press the **START/SET** pad to change the clock display mode.

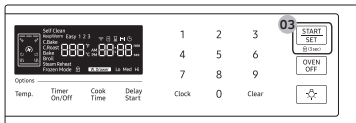

NOTE

You can set/change the clock or the kitchen timer before you start a cooking mode or while most cooking modes are operating. However, you cannot set or change the time if a time based function is operating (Time Bake, for example) or the Sabbath option is enabled.

Kitchen timer

The kitchen timer gives you an extra timer you can use to time cooking tasks such as boiling eggs. It does not, however, start or stop any cooking operation. You can set the timer from 1 minute to 9 hours and 59 minutes.

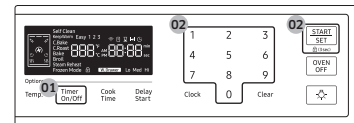

1. Press the **Timer On/Off** pad.

Press Once	Press Twice
To set Hours/Minutes	To turn off or cancel the timer

2. Press the number pads to enter the amount of time you want in minutes or hours and minutes. After pressing the number pads, press the **START/SET** pad to start the timer, or press the **Clear** pad to undo.

Oven vent / Cooling vent

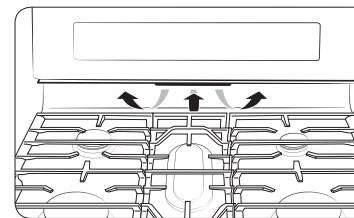

The oven vent is located under the oven Control panel. Proper air circulation prevents oven burner combustion problems and ensures good performance.

- Do not block the vent or the area around the vent.
- Use caution when placing items near the vent. Hot steam can cause them to overheat or melt.



Gas range

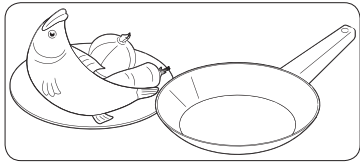

STEP 1

Put all ingredients into a cooking container (pan, pot, etc).

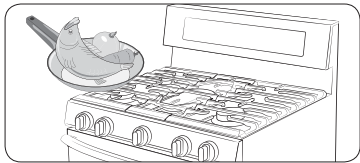

STEP 2

Place the container on a surface burner.

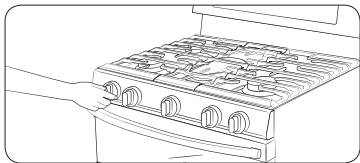

STEP 3

Ignite the surface burner.

Cookware

Requirements

- Flat bottom and straight sides.
- Tight-fitting lid.
- Well-balanced with the handle weighing less than the main portion of the pot or pan.

Material characteristics

- **Aluminum:** An excellent heat conductor. Some types of food may cause the aluminum to darken. However, anodized aluminum cookware resists staining and pitting.
- **Copper:** An excellent heat conductor but discolors easily.
- **Stainless steel:** A slow heat conductor with uneven cooking performance but is durable, easy to clean, and resists staining.
- **Cast-Iron:** A poor conductor but retains heat very well.
- **Enamelware:** Heating characteristics depend on the base material.
- **Glass:** A slow heat conductor. Use only glass cookware that is specified for range top cooking or oven use.





Size limitations

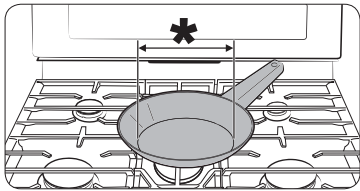

⚠ CAUTION

Do not place a small pan or pot with a bottom diameter of about 6 inches or less on the center grate. This cookware may tip over. Use the rear burners for this small-sized cookware.

* : 6 inches or less

- Always make sure cookware handles are turned to the side or rear of the cooktop and not over other surface burners. This will minimize the chance of burns, spills, and the ignition of flammable materials that can be caused if pots or pans are bumped accidentally.
- When using glass cookware, make sure it is designed for range top cooking.
- Never leave plastic items on the cooktop. Hot air from the vent can melt or ignite plastic items or cause a build up of dangerous pressure in closed plastic containers.
- Make sure you hold the handle of a wok or a small one-handed pot while cooking.

⚠ CAUTION

Do not use pots with diameter less than 5 inches (127mm) on either the Left Front burner or Right Front burner. The pot can tilt and cause burns or other injuries.

Center burner grate

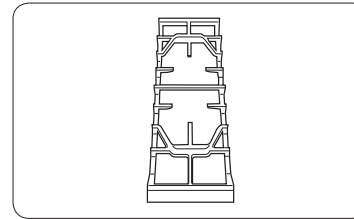

Samsung gas ranges come with a center burner grate. This grate fits over the center oval burner. The center burner grate should not be used over any other burners and no other center stovetop grates should be used with this range.

Wok grate (NX58*665*** only)

Woks are often used for stir frying, pan frying, deep frying, and poaching. The wok grate provided can support 12-14 inch pan or wok.

How to use wok grate

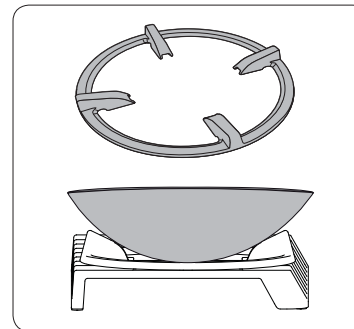

1. Before placing the wok grate, make sure that the burner is off and the grate is completely cool.
2. Place the wok grate on either side grate.
3. Place the wok on the wok grate. (Make sure that the wok sits securely on the work grate.)
4. Turn on the burner and adjust the flame size.





Gas range

⚠ CAUTION

- Do not remove the wok grate until the cooktop grates, surfaces, and wok grate are completely cooled.
- When using the cooktop, oven, or broil systems, the wok grate on the cooktop may become very hot. Always use oven gloves when placing or removing the wok grate.
- Do not use a pot or pan with a flat bottom on the wok grate or a wok with a diameter that is smaller than the wok ring diameter. If you do, it is likely that the pan, pot, or wok will tip over.
- Using an oversized wok may cause the flames to spread out and damage the surrounding cooktop.
- Make sure the wok sits securely on the wok grate.

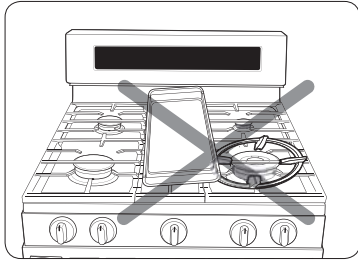

- Do not use the wok grate with the griddle at the same time.

Gas range

Using the griddle (NX58*665*** only)

The non-fixed, coated griddle provides an extra-large cooking surface for meat, pancakes, or other food usually prepared in a frying pan or skillet.

How to place the griddle

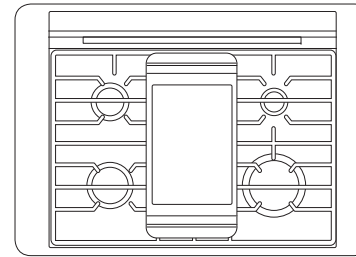

The griddle can only be used with the center burner. The griddle must be properly placed on the center grate as shown in the figure to the left. **DO NOT** remove the center grate when using the griddle.

How to cook

Preheat the griddle according to the guide below, and then adjust for the cooking conditions.

Type of food	Preheat time	Preheat condition	Cook condition
Pancakes	5 min	5 (MED-HI)	4 (MED)
Hamburgers	5 min	7 (HI)	5 (MED-HI)
Fried Eggs	5 min	7 (HI)	5 (MED-LO)
Bacon	-	None	4 (MED)
Breakfast Sausages	5 min	7 (HI)	5 (MED)
Grilled Cheese Sandwich	4 min	7 (HI)	6 (MED-HI)

⚠ CAUTION

- **DO NOT** remove the griddle until the cooktop grates, surfaces, and griddle are completely cooled.
- When the griddle plate is on the cooktop, it may become very hot when you use the cooktop, oven, or broil systems. Always use oven gloves when placing or removing the griddle.





NOTE

- Carefully put the griddle on the center grate.
- Griddle settings may need to be adjusted if the griddle is used for an extended time.
- Your griddle will discolor over time as it becomes seasoned with use.
- After use, return the griddle to storage only after it has cooled.

Important Note :

- DO NOT overheat the griddle. This can damage the non-fixed coating.
- DO NOT use metal utensils that can damage the griddle surface. Do not use the griddle as a cutting board.
- DO NOT place or store items on the griddle.
- DO NOT turn the griddle over and use the underside for cooking. Use the top side of the griddle only.
- DO NOT use the griddle for any purpose other than cooking.
- Avoid cooking extremely greasy foods. Grease spill overs can occur.
- The griddle can become hot when surrounding burners are in use.

Minimum and maximum settings

All the features listed in the table below have minimum and maximum time or temperature settings. A beep will sound each time a pad on the control panel is pressed and the entry is accepted. An error tone will sound in the form of a long beep if the entered temperature or time is below the minimum or above the maximum setting for the feature.

Feature	Temperature (°F)	
	Min	Max
Bake	175 °F (80 °C)	550 °F (285 °C)
Broil	LO	HI
Self Clean	2 hours	5 hours
Convection Bake	175 °F (80 °C)	550 °F (285 °C)
Convection Roast	175 °F (80 °C)	550 °F (285 °C)
Keep Warm	170 °F (77 °C)	
Bread Proof	100 °F (40 °C)	
Dehydrate	100 °F (40 °C)	175 °F (80 °C)
Slow Cook	LO	HI
Fronzen mode ¹	175 °F (80 °C)	550 °F (285 °C)
Steam Reheat ¹	175 °F (80 °C)	550 °F (285 °C)

¹ NX58*665***

Gas range



Gas range

Gas burners

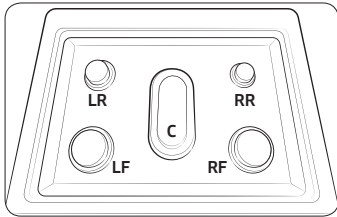

Each burner has a corresponding knob that lets you to set the flame level from LO to HI. In addition, each burner knob has a Lite setting. Turning a knob to Lite ignites the corresponding burner. The burner indicators are located above each knob and show which burner the knob controls. Each burner is designed for specific cooking purposes. See the table below.

Position	Purpose	Food type	Characteristics
Right Front (RF) 20,000 BTU ¹ 18,000 BTU ²	Power heating	Boiling food	Maximum output
Right Rear (RR) 5,000 BTU	Low simmering	Chocolate, casseroles, sauces	Delicate food that requires low heat for a long time
Center (C) 10,000 BTU	Grilling/Griddling	Pancakes, hamburgers, fried eggs, hot sandwiches	General-purpose cooking
Left Front (LF) 15,000 BTU ¹ 16,000 BTU ²	Quick heating	General	General-purpose cooking
Left Rear (LR) 9,500 BTU	General heating/ Low simmering	General food, casseroles, tomato sauce*	General-purpose cooking

¹ NX58*665***

² NX58*663***

* Tomato sauce needs to be stirred while it is simmering.

Ignition

Make sure all surface burners are properly installed. To light a burner:

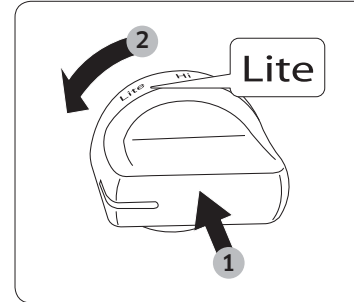

1. Push in the control knob, and then turn it to the Lite position. You will hear a "clicking" sound indicating the electronic ignition system is working properly.
2. After the surface burner lights, turn the control knob to shift it out of the Lite position and turn off the electronic ignition system.
3. Turn the control knob to adjust the flame level.





Manual ignition

If there is a power failure, you can ignite the burner manually. Use caution when doing this.

1. Hold a long gas grill lighter to the surface burner you want to light.
2. Push in the control knob for that burner, and then turn it to the Lite position. Turn on the grill lighter to ignite the burner.
3. After the burner is lit, turn the control knob to adjust the flame level.

Flame level

The flames on the burners should always stay under the cookware, and should not extend beyond the cookware bottom at any time.

⚠ WARNING

- Flames larger than the cookware bottom may result in a fire or physical injury.
- When you set a burner to simmer, do not turn the burner knob quickly. Watch the flame to make sure it stays on.
- After turning on a surface burner, check to make sure that the burner has ignited. Adjust the level of the flame by turning the burner knob.
- Always turn off the surface burner controls before removing cookware. All surface burner controls should be turned OFF when you are not cooking.
- Always turn the burners off before you go to sleep or go out.
- If you smell gas, turn off the gas to the range and call a qualified service technician. NEVER use an open flame to locate a leak.

Adjusting low flame settings on cooktop burners

All Cooktop burner flames should be checked at their lowest setting. Use the following steps to check and adjust the cooktop burner settings.

📖 NOTE

Low setting adjustments should always be made with two or more burners operating at the same time.

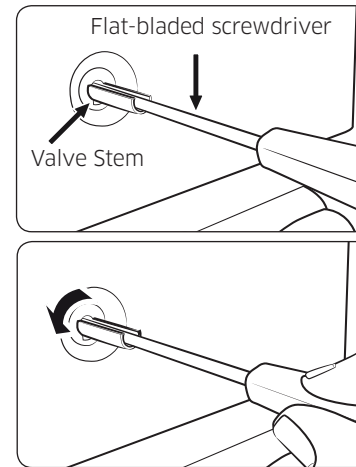

1. Turn on two or more surface burners, and then set them between MED and HI.
2. Quickly turn one of the control knobs counterclockwise to the lowest setting. The flame should stay lit. If the flame flutters or goes out, adjust the bypass valve on the control valve for that burner.
3. Pull the control knob for that burner straight off.
4. Using a small flat-bladed screwdriver, adjust the bypass valve screw in the base of the valve stem. Turn the bypass valve screw counterclockwise to increase the flame size.
5. Replace the control knob, and then recheck the low flame setting.
6. Repeat step 1 thru 5 to check and adjust the low flame settings on the remaining surface burners.





Gas oven

Using the Oven

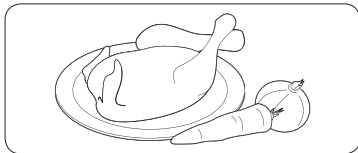

STEP 1

Put all ingredients in a heat-safe container.

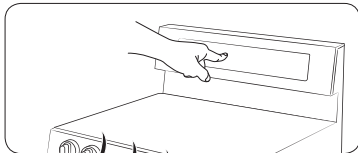

STEP 2

Select a cooking mode, and then start preheating.

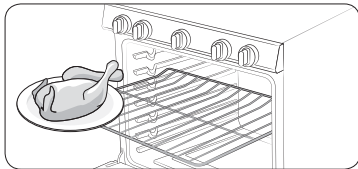

STEP 3

Place the container on a rack.

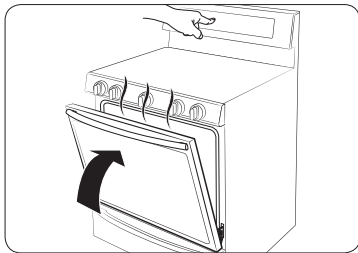

STEP 4

Close the door and start cooking.

NOTE

- The cooling fan automatically runs for a certain amount of time after cooking is complete.
- There can be slight popping sound during oven cooking. This sound may occur during normal oven burner cycling, when the oven burner flame is extinguished.

Baking, Roasting, and Convection Cooking

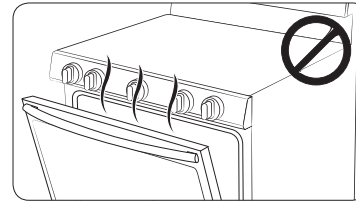

- Make sure to close the oven door before you start cooking.
- If you leave the door open for 20-30 seconds while the oven is in the convection baking/roasting, baking, or broiling modes, the oven burner shuts off. To restart the burner, close the door.

Baking and roasting

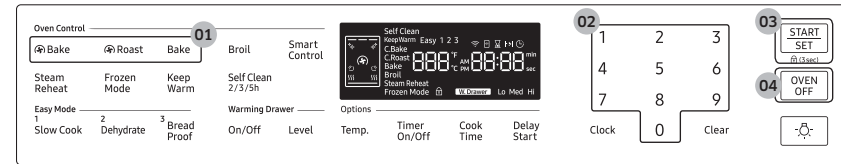

- Press the **Bake**, **Roast**, or **Bake** pad.
- If necessary, use the number pad to change the default temperature (350 °F). You can set the oven to any temperature from 175 °F to 550 °F. If you enter a wrong value, press the **Clear** pad, and then press the number pads again.
- Press the **START/SET** pad.
 - The oven preheats until it reaches the temperature you set.
 - When preheating is complete, place the food in the oven, and then close the door.
- When cooking is complete, press the **OVEN OFF** pad, and then take out the food.

NOTE

To change the temperature during cooking, press the **Temp.** pad, and then enter the desired temperature by pressing the number pads. After entering, press the **START/SET** pad.





Convection cooking

The convection fan at the back of the oven circulates hot air evenly throughout the oven cavity so that food is evenly cooked and browned in less time than with regular heat.

NOTE

When using convection cooking, always pre-heat the oven for the best results.

Convection baking	<ul style="list-style-type: none"> • Ideal for foods being cooked using multiple racks. • Good for large quantities of food. • Provides the best performance for cookies, biscuits, brownies, cupcakes, cream puffs, sweet rolls, angel food cake, and bread. • Cookies bake best when cooked on flat cookie sheets. • When convection baking using a single rack, place the rack in rack position 3 or 4. • When convection baking using two racks, place the racks in positions 3 and 5 (Cakes, Cookies). When convection baking using three racks, place the racks in positions 2, 4, and 6. • The oven automatically adjusts the temperature for convection baking.
Convection roasting	<ul style="list-style-type: none"> • Good for larger, tender cuts of meat, uncovered. • For best performance, place a broiler pan and grid under the meat or poultry. The pan catches grease spills and the grid prevents grease spatters. • Heated air circulates over, under, and around the food. Meat and poultry are browned on all sides as if they were cooked on a rotisserie.

Broiling

Broiling uses the oven broil burner at the top of the oven to cook and brown food. Meat or fish must be put on a broiling grid in a broiling pan. Preheating for 5 minutes before broiling is recommended.

Broiling

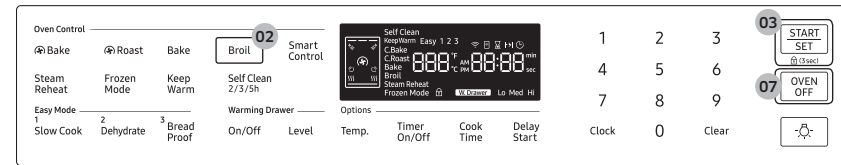

1. Put food on a broiling grid in a broiling pan.
2. Press the **Broil** pad once for high temperature broiling or twice for low.

NOTE

If you want to cancel broiling at this point, do not go on to Step 3 (Pressing the **START/SET** pad) or press the **OVEN OFF** pad.

3. Press the **START/SET** pad to start the broiler.
4. Let the oven pre-heat for 5 minutes.
5. Place the pan on the desired rack, and then close the oven door.
6. When one side of the food is browned, turn it over, close the oven door, and start cooking the other side.
7. When cooking is complete, press the **OVEN OFF** pad.

Gas oven



Gas oven

Broiling guide

- This is for reference only.
- Preheating for 5 minutes before broiling is recommended.
- The size, weight, thickness, starting temperature, and your doneness preference will affect broiling times.
- This guide is based on meats at refrigerator temperature.

Food	Doneness	Size	Thick-ness	Broil setting	Rack position		Cooking time	
					Single	Upper	1st side	2nd side
Hamburgers	Medium	9 patties	1"	HI	6	B	5:00-5:30	4:00-4:30
	Medium	9 patties	¾"	HI	6	B	5:00	4:00
Beef steak	Medium	-	1"	HI	6	B	7:00-6:00	6:00-5:00
	Medium	-	1½"	HI	6	B	9:00-10:00	6:00-7:00
Chicken pieces	Well done	2-2½ lbs.	¾"-1"	HI	5	A	15:00-17:00	13:00-15:00
Chicken breasts	Well done	2-3 pcs	-	HI	5	A	15:00-18:00	12:00-15:00
Pork chops	Well done	1 lb.	½"	HI	5	A	9:00-11:00	6:00-9:00
Lamb chops	Medium	10 oz.	1"	HI	4	A	8:00-12:00	5:00-8:00
	Well done	1 lb.	1½"	HI	4	A	10:00-15:00	7:00-11:00
Fish fillets	Well done	-	¼-½"	HI	5	A	5:00-6:00	3:00-4:00

⚠ CAUTION

Make sure to close the door after turning over the food.

Using the oven racks

Your gas oven range comes with 2 racks and 7 rack positions. The rack positions are delineated by rack guides which support the racks. Each rack guide has a stop that prevents racks from loosening during the oven's operation. Each rack has stoppers that need to be placed correctly on the rack guides. The stoppers prevent the racks from accidentally coming out of the oven completely when you pull the racks out.

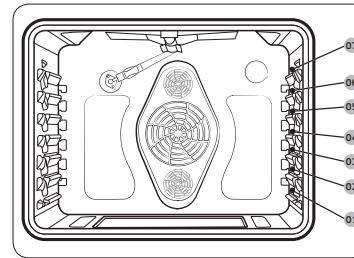

Type of food	Rack position
Hamburgers and steaks	6 or 7
Toast	5 or 6
Biscuits, muffins, brownies, cookies	4
Bundt or pound cakes	3
Angel food cake, pies	2
Roasts (small or large), ham, turkeys	1 or 2

⚠ CAUTION

- Do not cover an oven rack with aluminum foil. This will hamper heat circulation, resulting in poor baking.
- Do not place aluminum foil on the oven bottom. The aluminum can melt and damage the oven.
- Arrange the oven racks only when the oven is cool.
- When placing an oven rack in the topmost rack position (position 7), make sure the rack is situated stably on the embossed stop.
- When you use the gliding rack and a flat rack, always place the gliding rack below the flat rack.





NOTE

- The table on the previous page is for reference only.
- We recommend cooking pizza and pies using the 2nd rack position.

Multi-rack Baking

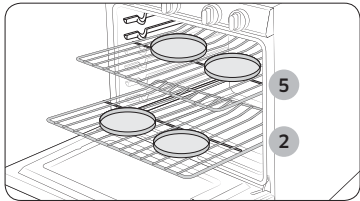

Cake pan positions

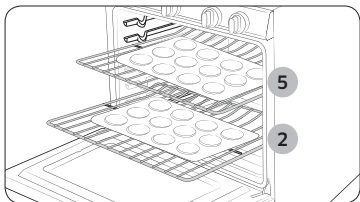

Cookie sheet positions

- When baking cakes on two racks place the racks in positions 2 and 5 for the best performance.
- When using 4 pans on two racks, place two pans in the rear of the upper rack, and the other two in the front of the lower rack.
- When baking multiple items on one rack, maintain a 1" to 1.5" (2.5 cm to 3.8 cm) space between items.
- When baking cookies on two racks, place the oven racks in positions 2 and 5.

Inserting and removing an oven rack

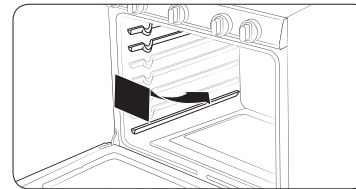

To insert an oven rack

1. Place the rear end of the rack on a rack guide.
2. Slide the rack into the rack guide while holding the front end of the rack.

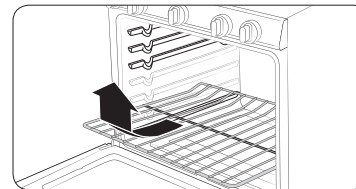

To remove an oven rack

1. Pull out the rack until it stops.
2. Pull up the front end of the rack and remove it from the rack guide.

Rack and Pan Placement

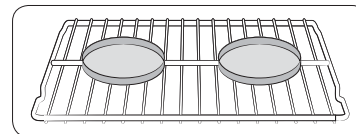

Single Oven Rack

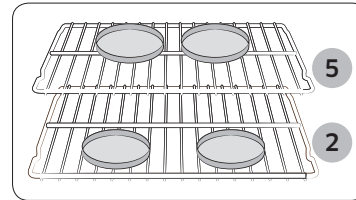

Multiple Oven Rack

Centering the baking pans in the oven as much as possible will produce better results. If baking with more than one pan, place the pans so each has at least 1" to 1½" of air space around it.

If baking on two racks, place the oven racks in positions 2 and 5 for the best results. When baking on a single oven rack, place the rack in position 3 or 4.

- When you use the Gliding Rack, place the Gliding Rack below the flat rack.



Gas oven

Cooking options

⚠ CAUTION

Food that can easily spoil, such as milk, eggs, fish, poultry, and meat, should be chilled in a refrigerator before they are placed in the oven. Even when chilled, they should not stand for more than 1 hour before cooking begins and should be removed promptly when cooking is completed.

Timed Cook

Timed cooking sets the oven to cook foods at a set temperature for a set length of time. The oven automatically turns off when it finishes.

Mode: Bake / Bake / Roast / Steam Reheat* / Frozen Mode* / Slow Cook / Dehydrate.

📖 NOTE

Modes with an asterisk (*) are only available on the NX58*665*** model.

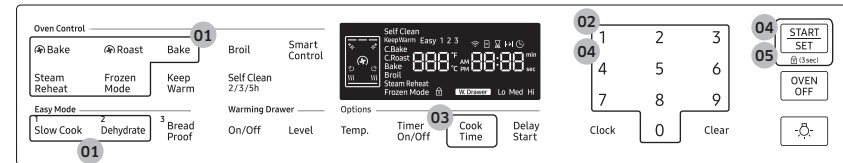

1. Press the pad corresponding to a desired cooking mode such as the **Bake** pad.
2. If necessary, change the temperature using the number pad.
3. Press the **Cook Time** pad.
4. Set the cooking time between 1 minute and 9 hours and 59 minutes (9:59) using the number pad. Press the **START/SET** pad to confirm the cooking time, or press the **Clear** pad to undo.
5. Press the **START/SET** pad to start cooking. The oven will automatically light and start preheating. The temperature will increase until it reaches the temperature you set.
6. When preheating is complete, put the container with the food on a rack, and then close the door. The oven starts cooking for the amount of time you set.
7. When the cooking time has elapsed, the oven will automatically shut off and then beep.

📖 NOTE

To change the programmed cooking time, press the **Cook Time** pad and enter a different time. Then, press the **START/SET** pad.





Delay Start

The Delay Start function lets you use the kitchen timer to automatically start and stop another cooking program at the time you want. Delay Start can be set before other cooking operations for up to 12 hours.

Mode: Bake / Bake / Roast / Frozen Mode* / Slow Cook / Dehydrate / Self-clean.

NOTE

Modes with an asterisk (*) are only available on the NX58*665*** model.

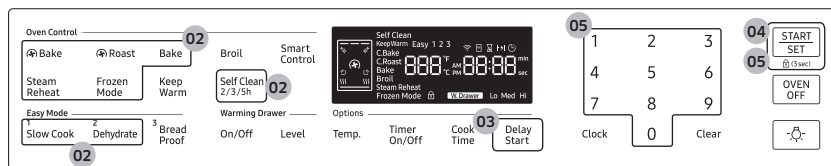

1. Place the container with the food on a rack, and then close the door.
2. Press the pad corresponding to a desired cooking mode such as the Bake pad.
3. Press the **Delay Start** pad to delay the starting time.
4. Press the **Delay Start** pad again to set AM or PM, and then press the **START/SET** pad.
5. Press the number pads to set the time to start cooking. Press the **Clear** pad to undo or press the **START/SET** pad to activate the "Delay Start" function.

NOTE

- To change the starting time, press the **Delay Start** pad, and then enter a new starting time. Then, press the **START/SET** pad.
- To use the Delay Start feature while using the Timed Cook feature, follow Steps 1 to 4 in the "Timed Cook" section, and then follow Steps 3 to 5 in the "Delay Start" section.
- To change the programmed cooking time, press the **Cook Time** pad and enter a different time. Then, press the **START/SET** pad.

Keep Warm

Keep cooked food warm at a low temperature up to 3 hours.

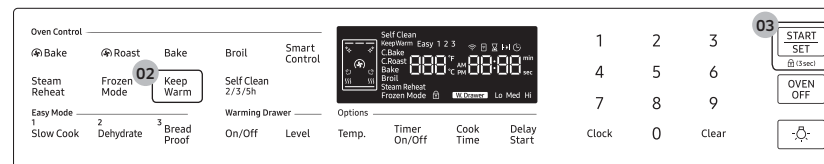

1. Place the container with the food on a rack, and then close the door.
2. Press the **Keep Warm** pad. To undo, press the **OVEN OFF** pad.
3. Press the **START/SET** pad on the left or right side of the panel. The oven heats up to 170 °F (77 °C).

NOTE

- You can cancel warming at any time by pressing the **OVEN OFF** pad.
- To set the warming function during a timed cooking, press the **Keep Warm** pad in timed cooking mode. When the timed cooking is complete, the oven will lower the temperature to the warming default, and keep that temperature until warming finishes or is canceled.



Gas oven

The Sabbath option



(For use on the Jewish Sabbath & Holidays)

Use this option only for baking on the Jewish Sabbath and Holidays. For more information, visit the website at <http://www.star-k.org>

With the Sabbath option

- The oven temperature can be set higher or lower after you have set this option.
- The display doesn't change and no beep sounds when you change the temperature.
- Once the oven is properly set for baking with the Sabbath option active, the oven will remain continuously on until the Sabbath feature is cancelled. This will override the factory preset 12 hour energy saving feature.
- If the oven light is needed during the Sabbath, press **OVEN LIGHT** before activating the Sabbath feature. Once the oven light is turned on and the Sabbath option is active, the oven light will remain on until the Sabbath option is turned off.
- If you want the oven light off, be sure to turn it off before activating the Sabbath feature.
- Do not use the surface cooktop when the Sabbath option is on.

To enable the Sabbath option

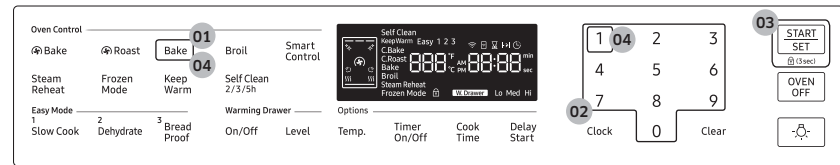

1. Press the **Bake** pad.
2. Enter a desired temperature using the number pad. The default temperature is 350 °F.
3. Press the **START/SET** pad. The display temperature changes after the oven temperature reaches 175 °F.
4. Press the **Bake** and **Number 1** pads simultaneously for 3 seconds to display "SAb". Once "SAb" appears, the oven control no longer beeps or displays any further changes.

NOTE

- You can change the oven temperature once baking starts, but the display will not change or beep. After changing the temperature, it takes 15 seconds before the oven recognizes the change.
- You can turn off the oven at any time by pressing **OVEN OFF**. However, this doesn't deactivate the Sabbath option.
- To deactivate the Sabbath option, hold down **Bake** and the **Number 1** simultaneously for 3 seconds.
- You can set the cooking time before activating the Sabbath option.
- After a power failure, the oven will not resume operation automatically. "SAb" will appear in the control panel, but the oven will not go back on. Food can be safely removed from the oven, but you should not turn off the Sabbath option and turn the oven back on until after the Sabbath/Holidays.
- After the Sabbath observance, turn off the Sabbath option by pressing and holding **Bake** and the **Number 1** simultaneously for at least 3 seconds.





⚠ CAUTION

- Do not attempt to activate any other functions except for Bake when the Sabbath option is on. Only the following pads will function properly: Number pads, Bake, Oven Start/Set, and Oven Off.
- Do not open the oven door or change the oven temperature for about 30 minutes after you have started the Sabbath option. Let the oven reach the set temperature. The oven fan operates only when the oven temperature increases.

Slow cook, Dehydrate, Bread Proof

Slow Cook

The Slow cook feature cooks food slowly at lower oven temperatures. The extended cooking times allow better distribution of flavors in many recipes. This feature is ideal for roasting beef, pork, and poultry. Slow cooking meats may cause the exterior of meats to become dark but not burnt. This is normal.

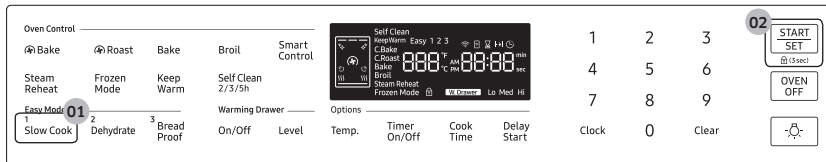

- Press **Slow Cook** once for HI or twice for LO.
- Press **START/SET**.

📖 NOTE

Use only 1 rack and place the rack in position 1 or 2 for the best results. Preheating the oven is not necessary.

Dehydrate

Dehydrate dries food or removes moisture from food via heat circulation. After drying the food, keep it in a cool and dry place. For fruit, adding lemon or pineapple juice or sprinkling sugar on the fruit helps the fruit retain sweetness.

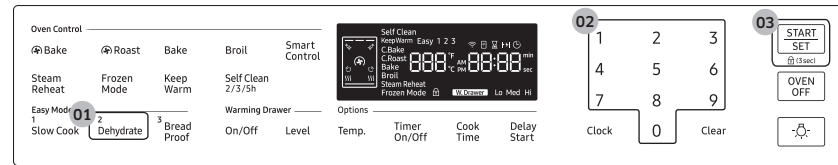

- Press **Dehydrate**. The default temperature is 150 °F.
- Enter the temperature you want on the number pad. (100 °F-175 °F)
- Press **START/SET**.

Recommended Dehydration Temperatures

Category	Rack position	Temperature (°F)
Vegetables or Fruit	3 or 4	100-150
Meat	3 or 4	145-175

📖 NOTE

- Drying time depends on the amount of moisture inside of the food, the size of the food, and the humidity in the air.
- Preheating the oven is not necessary.



Gas oven

Bread Proof

The Bread Proof function automatically provides the optimum temperature for the bread proof process, and therefore does not have a temperature adjustment. If you press **Bread Proof** when the oven temperature is above 100 °F, Hot will appear in the display. Because this function produces the best results when started while the oven is cool, we recommend that you wait until the oven has cooled down and Hot disappears from the display.

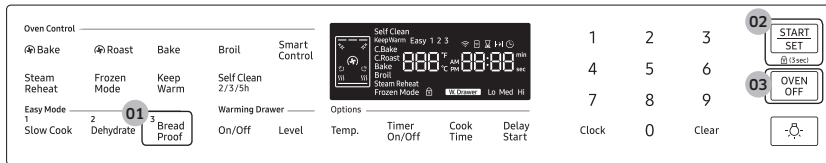

1. Press **Bread Proof**.
2. Press **START/SET**.
3. Press **OVEN OFF** at any time to turn off the Bread Proof function.

NOTE

Use rack position 3 for bread proofing.

CAUTION

- Do not use Bread Proof when the oven temperature is above 125 °F. If the temperature is above 125 °F, this mode will not heat the oven to the optimal temperature. Wait until the oven cools down.
- Do not use Bread Proof for warming food. The proofing temperature is not hot enough to keep food warm.
- Place the dough in a heat-safe container on rack position 3 or 4 and cover it with a cloth or with plastic wrap. You may need to anchor the plastic wrap underneath the container so that the oven does not blow it off the dough.
- To avoid lowering the temperature and extending proofing time, do not open the oven door.

Steam Reheat (NX58*665*** only)

The Steam Reheat function works in conjunction with the steam tray to provide additional moisture during baking.

The water in the steam tray generates steam in the oven cavity during the Steam Reheat cycle. The food can be reheated evenly without becoming dry.

Before operating Steam Reheat

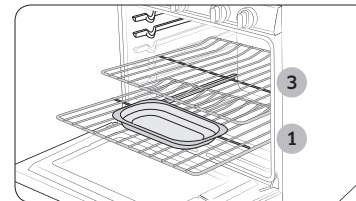

- Fill the steam tray with 8 oz (225 ml) of distilled or filtered water to supply moisture before preheating. Preheating should be done with the steam tray filled and in place.
- Place a flat rack in the lowest rack position, and then place the steam tray on it.
- Place another rack on the second or third rack position from the bottom, and then place the food to be reheated on that rack.
- After the Steam Reheat cycle is completed, empty the remaining water in the steam tray.
- You can set the cooking temperature 25 °F higher to reduce reheating time.

CAUTION

- Be careful when opening the oven door during or immediately after Steam Reheat cycle, hot steam can cause burns or injury.
- Use oven gloves to empty remaining water from the steam tray after cooking or wait until both oven and the steam tray have cooled enough to be handled safely.



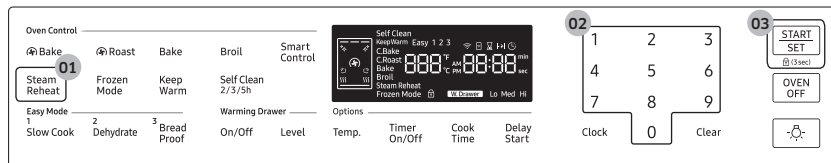

1. Press the **Steam Reheat** pad. Pressing the **OVEN OFF** pad or not pressing any pads for 30 seconds will cancel the function.
2. Press the number pads to enter the desired temperature. If you make a mistake, press **Clear**, and then press the number pads to enter the temperature again.
3. Press the **START/SET** pad to start.

Frozen Mode (NX58*665*** only)

Using the Frozen Mode, you can easily cook food that just came out of the freezer without defrosting. Just put the food in the oven, and then press the **Frozen Mode** pad.

Use this mode for single rack baking. It is good for frozen french fries, nuggets, pizza, fish or cheese sticks.

Before operating Frozen Mode

- Place the flat rack on the third or fourth rack position from the lowest available rack position.
- You can preheat the oven if you want.

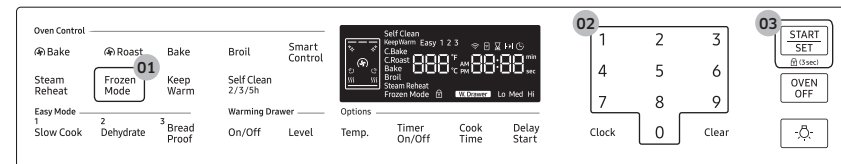

1. Press the **Frozen Mode** pad. Pressing the **OVEN OFF** pad or not pressing any pads for 30 seconds will cancel the function.
2. Press the number pads to enter the desired temperature. If you make a mistake, press **Clear**, and then press the number pads to enter the temperature again.
3. Press the **START/SET** pad to start.



Gas oven

Non-cooking functions

Temperature adjust

The oven temperature has been calibrated at the factory. When first using the oven, follow the recommended recipe times and temperatures. If it appears that the oven is too hot or too cool, you can recalibrate the oven temperature. Before recalibrating, test a recipe by using a temperature setting that is higher or lower than recommended. The baking results should help you decide how much of an adjustment is needed. The oven temperature can be adjusted by $\pm 35^\circ\text{F}$ ($\pm 19^\circ\text{C}$).

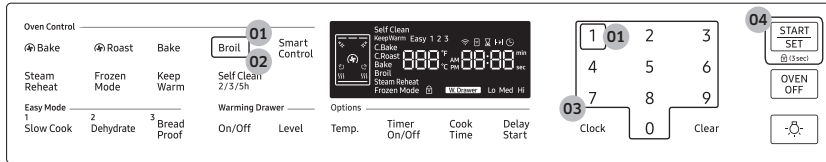

1. Press the **Broil** pad and **1** on the number pad simultaneously for 3 seconds.
2. Press the **Broil** pad to select a higher(+) or lower(-) temperature.
3. Enter an adjusting temperature value (0-35) using the number pad.
4. Press the **START/SET** pad to save the changes.

NOTE

This adjustment does not affect the broiling or the self-cleaning temperature, and is retained in memory after a power failure.

Temp. Unit ($^\circ\text{F}$ / $^\circ\text{C}$)

Change the temperature format of the oven to Fahrenheit or Centigrade. The default is Fahrenheit.

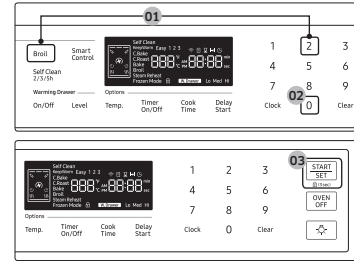

1. Press the **Broil** pad and **2** on the number pad simultaneously for 3 seconds.
2. Press **0** on the number pad to select Fahrenheit or Centigrade.
3. Press the **START/SET** pad to save the changes.

Auto Conversion

Auto Conversion automatically converts regular baking temperatures to convection baking temperatures. For example, if you enter a regular recipe temperature of 350°F and press **START/SET**, the oven displays the converted temperature of 325°F .

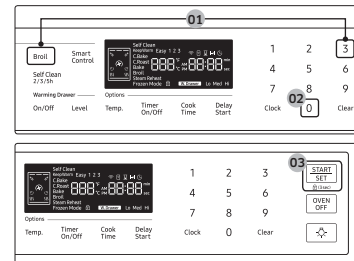

1. Press the **Broil** pad and **3** on the number pad simultaneously for 3 seconds.
2. Press **0** on the number pad to select Off or On. (Default setting is "OFF.")
3. Press the **START/SET** pad to save the changes.





Energy saving

This will automatically turn off the oven 12 hours after baking starts or 3 hours after broiling starts.

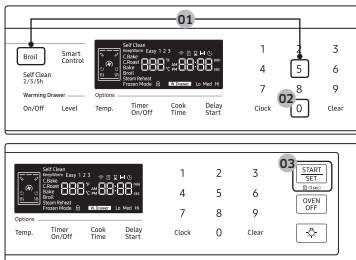

1. Press the **Broil** pad and **5** on the number pad simultaneously for 3 seconds.
2. Press **0** on the number pad to select Off or On.
3. Press the **START/SET** pad to save the changes.

Sound

Mute/unmute the range.

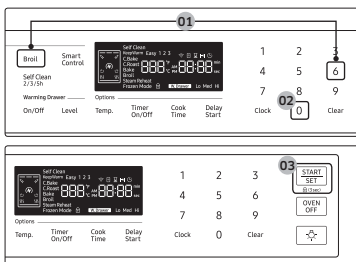

1. Press the **Broil** pad and **6** on the number pad simultaneously for 3 seconds.
2. Press **0** on the number pad to select unmute or mute.
3. Press the **START/SET** pad to save the changes.

Demo mode

This is used by retailers for display purposes only. In this mode, the heating elements do not operate.

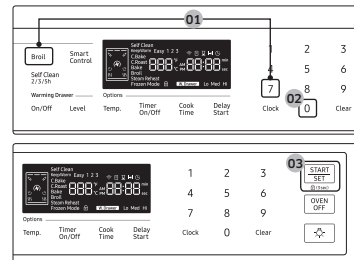

1. Press the **Broil** pad and **7** on the number pad simultaneously for 3 seconds.
2. Press **0** on the number pad to select Off or On.
3. Press the **START/SET** pad to save the changes.

Oven light

Turns the oven light on and off.

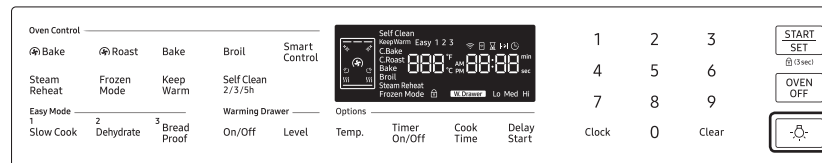

Press the **Oven Light** pad to turn the oven light on and off.

Gas oven



Gas oven

Oven lock

Lock the control panel and the door to prevent accidental operations and/or product tipping.

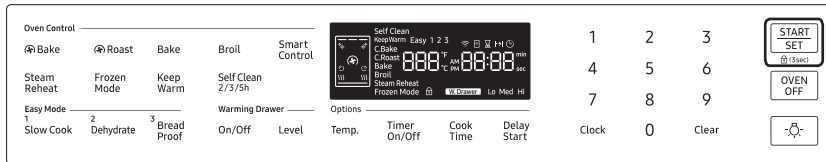

Press and hold the **START/SET** pad for 3 seconds to lock or unlock both the control panel and the door. When the range lock is on, the range panel does not operate and the range door is locked and cannot be opened.

Smart Control (NX58*665*** only)

How to connect the oven

1. Download and open the SmartThings app on your smart device.
2. Follow the app's on-screen instructions to connect your range.
3. Once the process is complete, the connected icon located on your range displays and the app confirms you are connected.
4. If the connection icon does not turn on, follow the instruction in the app to reconnect.

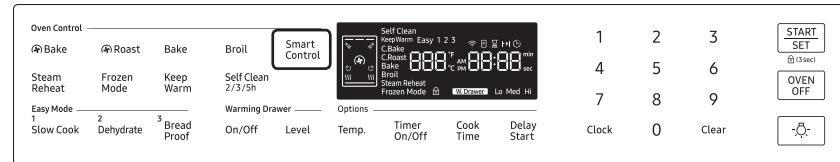



To control the oven remotely

1. Press **Smart Control**. appears in the display. The oven can now be controlled remotely using a connected remote device.
2. Select the oven icon in the SmartThings app to open the Oven Control app. When the app is connected to the oven, you can perform the following functions through the application:

Oven remote control using the SmartThings app	
Oven/ Cooktop Monitoring	<ul style="list-style-type: none"> • Check the status of the oven • Monitor the on/off status of each cooktop burner.
Oven Remote Control	<ul style="list-style-type: none"> • Set or adjust oven settings remotely.
My Cooking	<ul style="list-style-type: none"> • Turn the oven off remotely. • Once cooking starts, change the set cooking time or temperature remotely.
Error Check	<ul style="list-style-type: none"> • Automatically recognize errors.
<ul style="list-style-type: none"> • If is not shown in the display, you are still able to monitor the oven and cooktop status and turn the oven off. 	

WI-FI On/Off

If you activate the WI-FI Off mode, mobile devices cannot connect to the range.

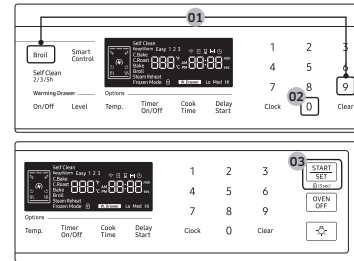

1. Press the **Broil** pad and **9** on the number pad simultaneously for 3 seconds.
2. Press **0** on the number pad to select Off or On.
3. Press the **START/SET** pad to save the changes.

NOTE

- Opening the oven door or pressing **Smart Control** will delete from the display and prevent most of the remote functions from operating.
- When oven cooking is finished or cancelled, is removed from the display.
- For safety reasons, you cannot turn on the gas oven remotely.
- For safety reasons, you must specify the cooking time to enable remote control.
- The oven continues operating even if the Wi-Fi connection is lost.
- **Smart Control** will not work properly if the Wi-Fi connection is unstable.
- See the SmartThings app manual for detailed information.



Warming drawer (NX58*665*** only)

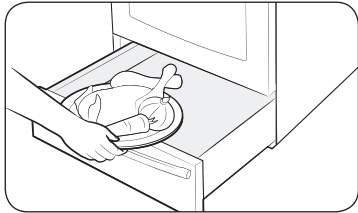

STEP 1

Put the cooked food in its container into the warming drawer.

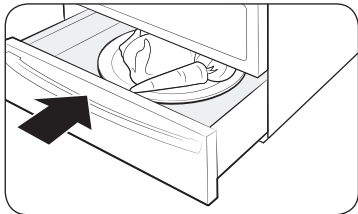

STEP 2

Close the warming drawer and set the Warming level. (Lo-Med-Hi)

Warming drawer

Keep your cooked food warm. This drawer is designed to keep hot food warm, but not for heating cold food. The drawer takes about 25 minutes to warm up.

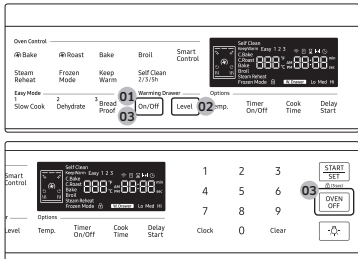

1. Press the Warming Drawer **On/Off** pad once.
2. Press the **Level** pad to change the warming temperature. The temperature will change in the following sequence: Lo, Med, Hi.
3. To turn off the warming drawer, press the Warming Drawer **On/Off** pad.
Important: Pressing the **OVEN OFF** pad does not turn off the warming drawer.

Recommendations

Category	Food type
Low	Soft rolls, empty dinner plates
Medium	Roasts (beef, pork, lamb), casseroles, vegetables, eggs, pastries, biscuits, hard rolls, gravies
High	Poultry, pork chops, hamburgers, pizza, bacon, fried foods

NOTES

- For best performance, do not keep food in the warming drawer for longer than 1 hour.
- Do not keep small quantities of food or heat-sensitive food (eggs, for example) in the warming drawer longer than 30 minutes.

CAUTION

- Do not use plastic containers or plastic wrap.
- Do not cover the inner area of the warming drawer with aluminum foil.
- Do not store liquid or water inside the warming drawer.
- Close food containers with a lid or cover them with aluminum foil.
- Remove food utensils before inserting food into the drawer.
- Place food on a heat safe dish after you remove it from the warming drawer.
- The warming drawer is disabled during a self-cleaning cycle.
- The warming drawer turns off automatically after 3 hours.





Maintenance

Cleaning

Control panel

First, lock the control panel and the door to prevent accidental operations and/or product tipping.

1. Press and hold the **START/SET** pad for 3 seconds to lock both the control panel and the door.
2. Clean the control panel using a soft cloth dampened with plain water, warm soapy water, or glass cleaner. Do not spray cleansers directly onto the control panel.
3. When done, press and hold the **START/SET** pad again for 3 seconds.

WARNING

- Make sure the control panel turns off and all surfaces of the range are cool before cleaning. Otherwise, you can get burned.
- If the range has been moved away from the wall, make sure the anti-tip device is reinstalled properly when the range has been put into place again. Otherwise, the range may tip over, causing physical injuries.
- Do not use steel-wool or abrasive cleansers of any kind. These can scratch or damage the surface.

Stainless steel surface

1. Remove any spills, spots, and grease stains using a soft, wet cloth.
2. Apply an approved stainless steel cleanser to a cloth or paper towel.
3. Clean one small area at a time, rubbing with the grain of the stainless steel if applicable.
4. When done, dry the surface using a soft, dry cloth.
5. Repeat steps 2 through 4 as many times as necessary.

CAUTION

- Do not use a steel-wool pad or abrasive cleanser on stainless steel surfaces. They will scratch the surface.
- Do not spray any type of cleanser into the manifold holes. The ignition system is located in those holes and must be kept free of moisture.

Racks

To keep the racks clean, remove them from the cavity, and soak them in lukewarm, soapy water. Then, scour impurities off of the racks using a plastic scouring pad. If the racks do not slide in and out smoothly after you have cleaned them, rub the side rail guides with wax paper or a cloth containing a few drops of cooking oil. This will help the racks glide more easily on their tracks.

NOTES

- Do not put the racks in a dishwasher.
- If a rack does not slide in and out smoothly, apply a few drops of cooking oil to the oven rack guides.
- If a rack becomes too difficult to slide in or out, lubricate the rack with graphite lubricant.
- To purchase the graphite lubricant, contact us at 1-800-SAMSUNG (726-7864).
- For online shopping, visit <http://www.samsungparts.com/Default.aspx> and search for part DG81-01629A.

CAUTION

- Do not leave the racks in the oven during the self-cleaning cycle. The extreme heat generated in this cycle can permanently peel off the rack coating and make it difficult to slide the racks on the guide rails.
- Do not spray cooking oil or lubricant directly onto the racks.

Door

Do not remove the inner gasket of the oven door for cleaning.

Inner side

- **Inner surface:** Clean the inner side of the door manually using a soapy plastic scouring pad, and then wipe with a dry cloth. Take care not to get the gasket wet or allow moisture into the door.
- **Inner glass:** The inner glass is cleaned automatically during the self-cleaning cycle.



Maintenance

Outer side

- **Outer surface:** Follow the cleaning instructions for stainless steel surfaces in the previous section.
- **Outer glass:** Clean the outer glass using a glass cleanser or soapy water. Rinse and dry thoroughly. Take care not to get the gasket wet or allow moisture into the door.

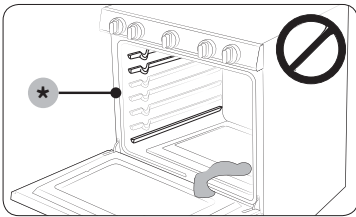

⚠ CAUTION

- Do not let moisture enter the door or contact the door gasket (*). Moisture may reduce the gasket's performance.
- Do not let moisture or water enter the burners, electrical controls, or switches.

Surface burners

Burner controls

Make sure all surface burner knobs are in the OFF position.

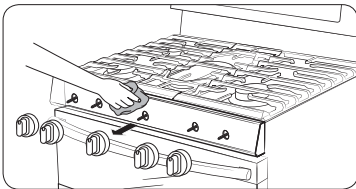

1. Pull the knobs off the control valve stems as shown.
2. Clean the knobs in warm, soapy water. Then, rinse and dry them thoroughly.
3. Clean the stainless steel surfaces using stainless steel cleaner.
4. Push the knobs back onto the control valve stems.

⚠ CAUTION

- Do not clean the control knobs in a dish washer.
- Do not spray cleansers directly onto the control panel. Moisture entering the electric circuits may cause electric shock or product damage.

Cooktop surface

The porcelain-enamelled cooktop surface needs to be kept clean. We recommend that you remove food spills immediately after they take place.

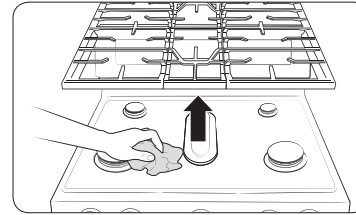

1. Turn off all surface burners.
2. Wait until all burner grates cool down, and then remove them.
3. Clean the cooktop surface using a soft cloth. If food spills run into the gaps of the burner components, remove the burner cap and the head, and then wipe up the spills.
4. When cleaning is finished, re-install the burner components, and then put the burner grates into position.

⚠ CAUTION

- Do not use a steel-wool pad or abrasive cleaner, which can scratch or damage the enamel surface.
- Do not remove the cooktop surface to clean it. The gas lines leading to the burner manifolds can be damaged, resulting in a fire or system failure.





Burner grates and components

Turn off all surface burners, and make sure they have all cooled down.

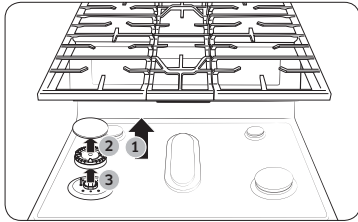

1. Remove the burner grates.
2. Remove the burner caps from the burner heads.
3. Remove the burner heads from the valve manifolds to reveal the starter electrodes.
4. Clean all removable grates and burner components in warm, soapy water. Do not use steel-wool pads or abrasive cleaners.
5. Rinse and dry grates and burner components thoroughly.

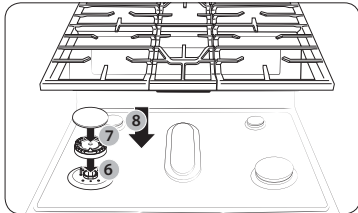

6. Return the burner heads to their positions on top of the manifold valves. Make sure a starter electrode is inserted through the hole in each burner head.
7. Return the burner caps to their positions on top of burner heads. To ensure proper and safe operation, make sure the burner caps lie flat on top of the burner heads.
8. Re-install the burner grates in their respective positions.
9. Turn on each burner and check if it operates properly. After verifying that a burner operates normally, turn it off.

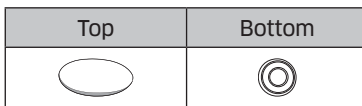

⚠ CAUTION

- The starter electrodes are not removable. Do not attempt to remove them by force.
- Make sure all burner components (heads and caps) are reinstalled properly. When installed properly, they are stable and rest flat.
- To avoid chipping, do not bang grates and caps against each other or hard surfaces such as cast iron cookware.

Self-cleaning

This self-cleaning oven uses high temperatures (well above cooking temperatures) to burn off leftover grease and residue completely or reduce them to a finely powdered ash that you can wipe away with a damp cloth.

⚠ CAUTION

- Do not leave small children unattended near the range during the self-cleaning cycle. The outside surfaces of the range can get extremely hot.
- Some birds are extremely sensitive to fumes from a self-cleaning gas oven. Relocate birds to a well-ventilated room away from the range.
- Do not line the oven, oven racks, or oven bottom with aluminum foil. Doing so will result in poor heat distribution, produce poor baking results, and cause permanent damage to the oven interior. The aluminum foil will melt onto and adhere to the interior oven surfaces.
- Do not force the oven door open during the self-cleaning cycle. This will damage the automatic door-locking system. The door automatically locks when the self-cleaning cycle is started and stays locked until the cycle is cancelled and the oven temperature is below 400 °F.
- Use caution when opening the oven door after the self-cleaning cycle. The gas oven will still be VERY HOT and hot air and steam might escape when the door is open.
- Wipe off any excess spillage before using the self-cleaning operation.
- Do not use oven cleaners. Commercial oven cleaners or oven liners should NEVER be used in or around any part of the oven. Residue from oven cleaners will damage the inside of the oven during a self-cleaning operation.





Maintenance

How to run a self-cleaning cycle

Make sure the door lock is released. Remove all racks from the oven cavity.

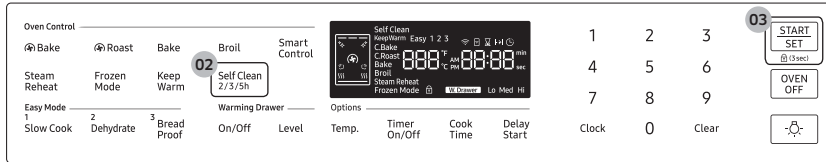

1. Make sure the oven door is unlocked and closed completely.
2. Press the **Self Clean** pad once. Then, select the cleaning time by pressing the **Self Clean** pad one or more times in accordance with the table below.

Once	Twice	Three times
3 hour	5 hour	2 hour

3. Press the **START/SET** pad. The oven door is locked and the oven begins to heat up.
4. When the cycle is complete, the oven beeps 6 times. The door will remain locked and the Lock icon will blink until the oven temperature falls below 400 °F (204 °C).
5. When the Lock icon changes to an open lock, you can open the oven door. The Lock icon changes to an open lock when the oven temperature drops below 400 °F (204 °C).
6. Press the **OVEN OFF** pad to display the time of day.

⚠ CAUTION

Do not use the surface burners while the gas oven is performing a self-cleaning cycle.

⚠ WARNING

Be sure all controls are OFF and all surfaces are COOL before cleaning any part of the range.

📖 NOTE

Make sure all surface burners are off while the oven is performing a self cleaning cycle. Self-clean will not operate if a surface burner is on.

To delay starting the self-cleaning cycle

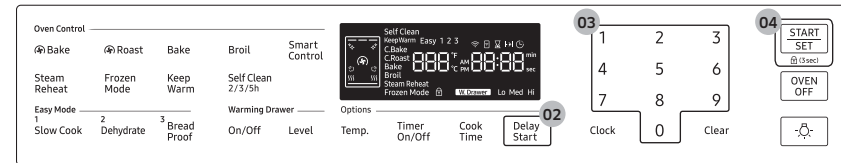

1. Repeat steps 1 and 2 on the previous page.
2. Press the **Delay Start** pad. The oven door locks.
3. Set the time you want the oven to start self-cleaning using the number pad.
4. Press the **START/SET** pad. The oven will start self-cleaning at your specified time.

To cancel the self-cleaning cycle

You may find it necessary to stop or interrupt a self-cleaning cycle due to smoke in the oven. To turn off the self-cleaning cycle, press the **OVEN OFF** pad. The cycle turns off, but the door remains locked and the Lock icon blinks until the oven temperature falls below 400 °F (204 °C).

After self-cleaning

- The door stays locked until the internal oven temperature falls below 400 °F.
- When the oven has cooled down, wipe the oven surfaces with a cloth to remove ash residue.
- Stubborn stains can be removed using a steel-wool pad. Lime deposits can be removed using a vinegar-soaking cloth.
- If you are not satisfied with the cleaning results, repeat the cycle. "HOT" appears on the display until the oven cools down. Wait until the message disappears, and then start a new cycle.
- The cooling fan automatically runs for certain amount of time after self-cleaning.
- Self-cleaning does not operate within 2 hours after running the self-cleaning cycle.

⚠ CAUTION

Do not attempt to open the oven door immediately after the self-cleaning cycle is complete. The oven is still very hot when the door unlocks. Escaping hot air and/or steam could burn you.





Replacing the Oven Light

The oven light is a standard 40-watt appliance bulb. It comes on when you open the oven door.

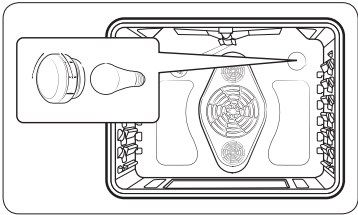

1. Turn off the oven.
2. Make sure the oven and oven light are cool.
3. Open the door, and remove the glass cover by turning it counterclockwise.
4. Remove the oven light from the socket by turning it counterclockwise.
5. Insert a new 40-watt appliance bulb into the socket, and then turn it clockwise to tighten.
6. Reinsert the glass cover, and then turn it clockwise to tighten.

⚠ CAUTION

To prevent electric shock, make sure the oven is turned off and cool before replacing the oven light.

📄 NOTE

- The oven light does not operate during the self-cleaning cycle.
- Remove the racks if they prevent you from accessing the oven light.

Oven Door: Remove and Re-Install

To remove the oven door

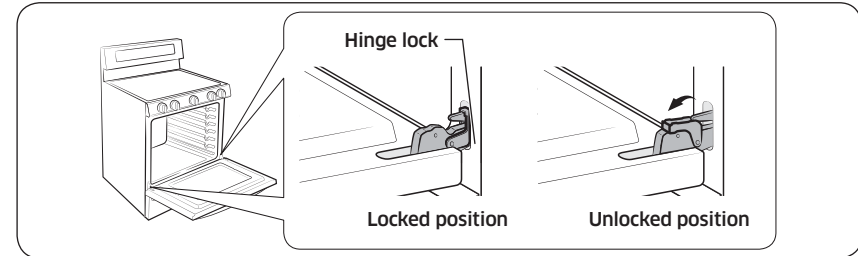

1. Turn off the oven.
2. Fully open the oven door.
3. Pull the hinge locks away from the oven body and down toward the door frame into the unlocked position.

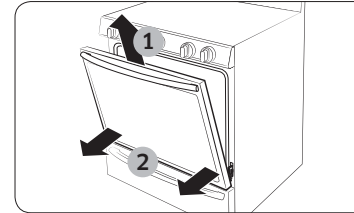

4. Close the door to 5 degrees from vertical. This is the removal position.
5. While holding both sides of the oven door tightly, lift it up and out until the hinge arms come clear of the slots at the bottom of the oven door.
6. Place the door in a safe location.

⚠ WARNING

- The door is very heavy. Be careful when removing and lifting the door. Do not lift the door by the handle.
- Take care when moving the oven door. Improper handling could result in physical injury.
- To prevent electric shock, make sure the oven is turned off before removing the oven door.





Maintenance

To re-install the oven door

1. Firmly grasp both sides of the door at the top.
2. With the door at the same angle as the removal position, slide the indentation of the hinge arm into the bottom edge of the hinge slot. The notch in the hinge arm must be fully inserted into the bottom of the slot.

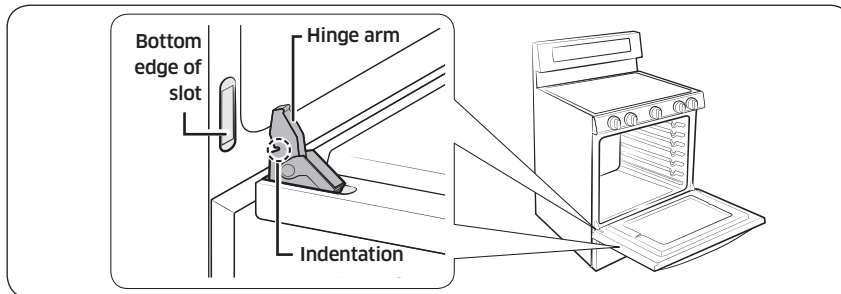

3. Open the door fully. If the door will not open fully, the indentation is not inserted correctly in the bottom edge of the slot.
4. Push the hinge locks up against the front frame of the oven cavity into the locked position.

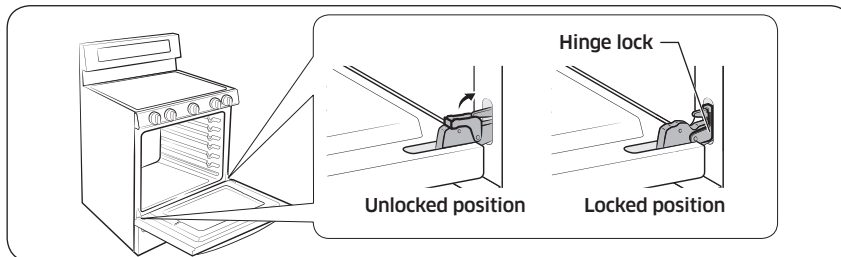

5. Close the oven door.

Warming / Storage drawer

Warming drawer (NX58*665*** Only)

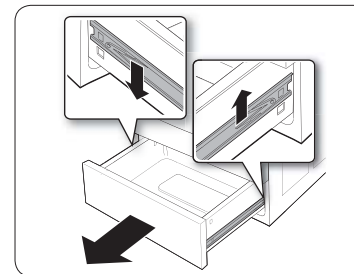

1. Slide open the drawer until it stops.
2. Locate the roller guide clips on either side. Using both hands, pull down the left clip while lifting the right clip, and then remove the drawer.
3. Clean the drawer in warm, soapy water using a cloth or soft brush. Then, rinse and dry it thoroughly.

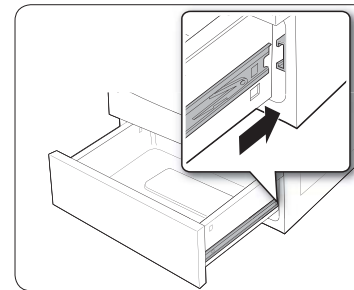

4. Put the drawer in the roller guides on either side, and then snap the clips into place.

Storage drawer (NX58*663*** Only)

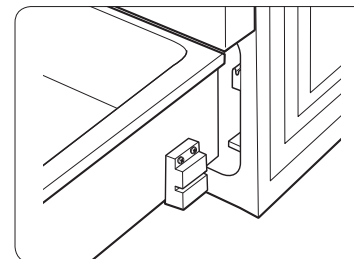

1. Slide open the drawer until it stops.
2. Pull the drawer with lifting it for removal.
3. Clean the drawer in warm, soapy water using a cloth or soft brush. Then, rinse and dry it thoroughly.
4. Push in the drawer while slightly lifting the front to close it.





Troubleshooting

If you encounter a problem with the range, check the tables starting below, and then try the suggested actions.

Checkpoints

Gas safety

Problem	Possible cause	Action
You smell gas.	The surface burner knob is not in the OFF position and the burner is not lit.	Turn the burner knob to OFF .
	There is a gas leak.	Clear the room, building, or area of all occupants. Immediately call your gas supplier from a neighbor's phone. Do not call from your phone. It is electrical and could cause a spark that could ignite the gas. Follow the gas supplier's instructions. If you cannot reach your gas supplier, call the fire department.

Surface burner

Problem	Possible cause	Action
All burners do not light.	The power cord is not plugged into the electrical outlet.	Make sure the electrical plug is plugged into a live, properly grounded outlet.
	A fuse in your home may be blown or the circuit breaker tripped.	Replace the fuse or reset the circuit breaker.
	The gas supply is not properly connected or turned on.	See the Installation Instructions that came with your range.

Problem	Possible cause	Action
The surface burners do not light.	The control knob is not set properly.	Push in the control knob and turn it to the Lite position.
	The burner caps are not in place. The burner base is misaligned.	Clean the electrodes. Put the burner cap on the burner head. Align the burner base.
A surface burner clicks during operation.	The control knob has been left in the Lite position.	After the burner lights, turn the control knob to a desired setting. If the burner still clicks, contact a service technician.
The burners do not burn evenly.	The surface burner components and caps are not assembled correctly and level.	See page 39 .
	The surface burners are dirty.	Clean surface burner components. (See page 39 .)
Very large or yellow surface burner flames.	The wrong burner orifice is installed.	Check the burner orifice size. Contact your installer if you have the wrong orifice (LP gas instead of natural gas or natural gas instead of LP gas).
The surface burners light but the oven burners do not light.	The oven door lock is turned on.	The display will show the Lock icon. Hold the oven door open and press the START/SET pad for 3 seconds. The oven will beep and the Lock icon will turn off.
	The Gas Pressure Regulator shut off switch is in the off position.	Call a qualified service technician.



Troubleshooting

Oven

Problem	Possible cause	Action
The oven control beeps and displays an information code.	There may be a malfunction. See the "Information codes" chart on page 47 .	Press the OVEN OFF pad, and then restart the oven. If the problem persists, disconnect all power to the range for at least 30 seconds and then reconnect the power. If this does not solve the problem, call for service.
Very large or yellow oven burner flames.	The oven burner air adjustment shutters need to be adjusted.	Call for a qualified service technician.
	The gas supply is not properly connected or turned on.	See the Installation Instructions that came with your range.
The oven temperature is too hot or cold.	Oven thermostat needs adjustment.	See page 32 .
An oven burner will not shut off.	The oven door lock is turned on.	The display will show the Lock icon. Hold the oven door open and press the START/SET pad for 3 seconds. The oven will beep and the Lock icon will turn off.
	The Sabbath function has been activated.	SAb and the time of day will show in the display. All other controls and signals will be deactivated. To turn off the oven only, press the OVEN OFF pad. To cancel the Sabbath function and reactivate the controls and signals, press and hold the Bake and the Number 1 pads simultaneously for 3 seconds.

Problem	Possible cause	Action
The oven light (lamp) will not turn on.	The oven door lock is turned on.	The display will show the Lock icon. Hold the oven door open and press the START/SET pad for 3 seconds. The oven will beep and the Lock icon will turn off.
	The Sabbath function has been activated.	SAb and the time of day will show in the display. All other controls and signals will be deactivated. To cancel the Sabbath function and reactivate the light switch and other controls, press and hold the Bake and the Number 1 pads simultaneously for 3 seconds.
	A loose or burned-out bulb.	See page 41 .
	The switch operating the oven light needs to be replaced.	Call for a qualified service technician.
Oven smokes excessively during broiling.	Meat or food was not properly prepared before broiling.	Cut away excess fat and/or fatty edges that may curl.
	An improperly positioned top oven rack.	See broiling guide on page 24 .
	The controls are not being set properly.	See page 23 .
	Greasy buildup on oven surfaces.	Regular cleaning is necessary when broiling frequently.





Problem	Possible cause	Action
Cooking is finished, but the cooling fan is still running.	The fan automatically runs for a certain amount of time to ventilate the inside of the oven.	This is not a malfunction.
Oven will not self-clean.	The oven door lock is turned on.	The display will show the Lock icon. Hold the oven door open and press the START/SET pad for 3 seconds. The oven will beep and the Lock icon will turn off.
	The oven is too hot.	Let the oven cool down and reset the controls. The self-clean cycle will not lock the oven door if the oven temperature is too hot. The door must lock before the self-clean cycle can start.
	The self-cleaning oven controls are not properly set.	Reset the self-cleaning oven controls. (See page 39 and 40.)
Crackling or popping sound.	This is normal.	This is the sound of the metal heating and cooling during any cooking or cleaning function.

Problem	Possible cause	Action
Excessive smoking during a self-cleaning cycle.	This is the first time the oven has been cleaned.	This is normal. The oven will always smoke more the first time it is cleaned. Wipe up all excessive soil before starting the self-cleaning cycle. If smoke persists, press the OVEN OFF pad. Open the windows to clear the smoke from the room. After the oven has cooled and unlocked, wipe up excessive soil and reset the oven for self-cleaning.
The oven door will not open after a self-cleaning cycle.	This is normal.	The oven door will stay locked until the oven temperature drops below 400 °F.
The oven is not clean after a self-cleaning cycle.	A fine dust or ash is normal.	This can be wiped clean with a damp cloth. Set the self-cleaning cycle for a longer cleaning time. The cycle was not long enough to burn off the dirt buildup. Extremely dirty ovens require hand-cleaning of excessive spillovers and food buildup before you start a self-cleaning cycle. Multiple self-cleaning cycles may be necessary to completely clean the oven.





Troubleshooting

Problem	Possible cause	Action
Steam or smoke coming from under the control panel.	This is normal.	The oven vent is located there. More steam is visible when you use the convection functions or when baking or roasting multiple items at the same time.
A burning or oily odor coming from the vent.	This is normal for a new oven and will disappear within 1/2 hour of the first bake cycle.	To speed the process, set a self-cleaning cycle for a minimum of 3 hours. (See page 39 and 40 .)
A strong odor.	This is temporary.	The insulation around the inside of the oven emits an odor the first few times the oven is used.
Oven racks are difficult to slide.	This is normal.	Apply a small amount of vegetable oil to a paper towel and wipe the edges of the oven racks with the paper towel. Racks become dull and hard to slide if they are left in the oven during a self-clean cycle.
Fan noise.	This is normal.	The convection fan runs until the function is over or the door is opened.
The convection fan is not working.	This is normal.	The fan starts automatically when the oven reaches the preheat temperature.

Others

Problem	Possible cause	Action
The product is not level.	The appliance has been installed improperly. The leveling leg(s) is (are) damaged or uneven.	Make sure the floor is level, strong, and stable. If the floor sags or slopes, contact a carpenter. Check and level the range. (See the Installation Instructions.)
	The kitchen cabinets are not properly aligned and make the range appear to be not level.	Ensure that cabinets are square and provide sufficient room for installation.
The display goes blank.	The electrical outlet Ground Fault Interrupter (GFI or GFCI) has been tripped and needs to be reset. Your digital control has been damaged.	Replace fuse or reset circuit breaker.
Food does not bake or roast properly in the oven.	The wrong cooking mode is selected.	See page 22 .
	The oven racks have not been positioned properly for the foods being cooked.	See page 24 .
	Incorrect cookware or cookware of improper size is being used.	See page 16 .
	The oven thermostat needs adjustment.	See page 32 .
	There is aluminum foil on the racks and/or oven bottom.	Remove foil.
	The clock or timers are not set correctly.	See page 15 .



Problem	Possible cause	Action
Food does not broil properly in the oven.	The oven controls are not set properly.	See page 23 .
	The oven door was not closed during broiling.	See page 22 .
	The rack has not been properly positioned.	See the broiling guide on page 24 .

Information codes

Code symbol	Meaning	Solution
C-20	Check the oven sensor.	<ol style="list-style-type: none"> 1. Press the OVEN OFF pad, and then restart the oven. 2. If the problem persists, disconnect all power to the range for at least 30 seconds, and then reconnect the power.
C-21	Oven overheating.	
C-30	Check the PBA NTC Sensor	
C-31	Check the PBA NTC Sensor	
C-d1	Check the door lock.	
C-F2	Check the Touch PBA signals.	
C-d0	Check the control panel pads	
** If these solutions do not solve the problem, contact a local Samsung service center or call 1-800-SAMSUNG (1-800-726-7864).		

Warranty (U.S.A)

PLEASE DO NOT DISCARD.

SAMSUNG GAS RANGE

LIMITED WARRANTY TO ORIGINAL PURCHASER WITH PROOF OF PURCHASE

This SAMSUNG brand product, as supplied and distributed by SAMSUNG ELECTRONICS AMERICA INC. (SAMSUNG) and delivered new, in the original carton to the original consumer purchaser, is warranted by SAMSUNG against manufacturing defects in materials or workmanship for the limited warranty period, starting from the date of original purchase, of:

One (1) Year Parts and Labor

This limited warranty is valid only on products purchased and used in the United States that have been installed, operated, and maintained according to the instructions attached to or furnished with the product. To receive warranty service, the purchaser must contact SAMSUNG at the address or phone number provided below for problem determination and service procedures. Warranty service can only be performed by a SAMSUNG authorized service center. The original dated bill of sale must be presented upon request as proof of purchase to SAMSUNG or SAMSUNG's authorized service center to receive warranty service.

SAMSUNG will provide in-home service within the contiguous United States during the warranty period at no charge, subject to availability of SAMSUNG authorized servicers within the customer's geographic area. If in-home service is not available, SAMSUNG may elect, at its option, to provide transportation of the product to and from an authorized service center. If the product is located in an area where service by a SAMSUNG authorized servicer is not available, you may be responsible for a trip charge or required to bring the product to a SAMSUNG authorized service center for service.

To receive in-home service, product must be unobstructed and accessible to the service agent.



Warranty (U.S.A)

During the applicable warranty period, a product will be repaired, replaced, or the purchase price refunded, at the sole option of SAMSUNG. SAMSUNG may use new or reconditioned parts in repairing a product, or replace the product with a new or reconditioned product. Replacement parts and products are warranted for the remaining portion of the original product's warranty or ninety (90) days, whichever is longer. All replaced parts and products are the property of SAMSUNG and you must return them to SAMSUNG.

This limited warranty covers manufacturing defects in materials or workmanship encountered in normal household, noncommercial use of this product and shall not cover the following: damage that occurs in shipment, delivery, installation, and uses for which this product was not intended; damage caused by unauthorized modification or alteration of the product; product where the original factory serial numbers have been removed, defaced, changed in any way, or cannot be readily determined; cosmetic damage including scratches, dents, chips, and other damage to the product's finishes; damage caused by abuse, misuse, pest infestations, accident, fire, floods, or other acts of nature or God; damage caused by use of equipment, utilities, services, parts, supplies, accessories, applications, installations, repairs, external wiring or connectors not supplied or authorized by SAMSUNG; damage caused by incorrect electrical line current, voltage, fluctuations and surges; damage caused by failure to operate and maintain the product according to instructions; in-home instruction on how to use your product; and service to correct installation not in accordance with electrical or plumbing codes or correction of household electrical or plumbing (i.e., house wiring, fuses, or water inlet hoses). In addition, damage to the glass cooktop caused by (i) use of cleaners other than the recommended cleaners and pads or (ii) hardened spills of sugary materials or melted plastic that are not cleaned according to the directions in the use and care guide are not covered by this limited warranty.

The cost of repair or replacement under these excluded circumstances shall be the customer's responsibility.

Visits by an authorized servicer to explain product functions, maintenance or installation are not covered by this limited warranty. Please contact SAMSUNG at the number below for assistance with any of these issues.

EXCLUSION OF IMPLIED WARRANTIES

IMPLIED WARRANTIES, INCLUDING THE IMPLIED WARRANTIES OF MERCHANTABILITY OR FITNESS FOR A PARTICULAR PURPOSE, ARE LIMITED TO ONE YEAR OR THE SHORTEST PERIOD ALLOWED BY LAW. Some states do not allow limitations on how long an implied warranty lasts, so the above limitations or exclusions may not apply to you. This warranty gives you specific rights, and you may also have other rights, which vary from state to state.

LIMITATION OF REMEDIES

YOUR SOLE AND EXCLUSIVE REMEDY IS PRODUCT REPAIR, PRODUCT REPLACEMENT, OR REFUND OF THE PURCHASE PRICE AT SAMSUNG'S OPTION, AS PROVIDED IN THIS LIMITED WARRANTY. SAMSUNG SHALL NOT BE LIABLE FOR SPECIAL, INCIDENTAL OR CONSEQUENTIAL DAMAGES, INCLUDING BUT NOT LIMITED TO TIME WAY FROM WORK, HOTELS AND/OR RESTAURANT MEALS, REMODELING EXPENSES, LOSS OF REVENUE OR PROFITS, FAILURE TO REALIZE SAVINGS OR OTHER BENEFITS REGARDLESS OF THE LEGAL THEORY ON WHICH THE CLAIM IS BASED, AND EVEN IF SAMSUNG HAS BEEN ADVISED OF THE POSSIBILITY OF SUCH DAMAGES. Some states do not allow exclusion or limitation of incidental or consequential damages, so the above limitations or exclusions may not apply to you. This warranty gives you specific rights, and you may also have other rights, which vary from state to state.

SAMSUNG does not warrant uninterrupted or error-free operation of the product. No warranty or guarantee given by any other person, firm, or corporation with respect to this product shall be binding on SAMSUNG.

To obtain warranty service, please contact SAMSUNG at:

Samsung Electronics America, Inc.
85 Challenger Road
Ridgefield Park, NJ 07660
1-800-SAMSUNG (726-7864) and www.samsung.com/us/support





Registration

Please register your product online at www.samsung.com/register.

Questions

For questions about features, operation/performance, parts, accessories, or service, call 1-800-SAMSUNG (726-7864), or visit our Web site at www.samsung.com/us/support.

Model # _____ Serial # _____

Please attach your receipt (or a copy) to this manual. You may need it, along with your model and serial number, when calling for assistance.

Warranty (CANADA)

PLEASE DO NOT DISCARD.

SAMSUNG GAS RANGE

LIMITED WARRANTY TO ORIGINAL PURCHASER

This SAMSUNG brand product, as supplied and distributed by SAMSUNG ELECTRONICS CANADA INC. (SAMSUNG) and delivered new, in the original carton to the original consumer purchaser, is warranted by SAMSUNG against manufacturing defects in materials and workmanship for a limited warranty period of:

One (1) Year Parts and Labor

This limited warranty begins on the original date of purchase, and is valid only on products purchased and used in the Canada. To receive warranty service, the purchaser must contact SAMSUNG for problem determination and service procedures. Warranty service can only be performed by a SAMSUNG-authorized service center, and any unauthorized service will void this warranty. The original dated bill of sale must be presented upon request as proof of purchase to SAMSUNG or SAMSUNG's authorized service center. Samsung will provide in-home service during the one (1) year warranty period at no charge subject to availability within the contiguous Canada. In-home service is not available in all areas. To receive in-home service, product must be unobstructed and accessible to the service agent. If service is not available, Samsung may elect to provide transportation of the product to and from an authorized service center.

SAMSUNG will repair or replace this product, at our option and at no charge as stipulated herein, with new or reconditioned parts or products if found to be defective during the limited warranty period specified above. All replaced parts and products become the property of SAMSUNG and must be returned to SAMSUNG. Replacement parts and products assume the remaining original warranty, or ninety (90) days, whichever is longer.



Warranty (CANADA)

This limited warranty shall not cover cases of incorrect electric current, voltage or supply, light bulbs, house fuses, house wiring, cost of a service call for instructions, or fixing installation errors. Furthermore, damage to the cooktop caused by the use of cleaners other than the recommended cleaners and pads and damage to the cooktop caused by hardened spills of sugary materials or melted plastic that are not cleaned according to the directions in the use and care guide are not covered. SAMSUNG does not warrant uninterrupted or error-free operation of the product.

EXCEPT AS SET FORTH HEREIN, THERE ARE NO WARRANTIES OR CONDITIONS ON THIS PRODUCT EITHER EXPRESS OR IMPLIED AND SAMSUNG DISCLAIMS ALL WARRANTIES AND CONDITIONS INCLUDING, BUT NOT LIMITED TO, ANY IMPLIED WARRANTIES AND CONDITIONS OF MERCHANTABILITY, INFRINGEMENT, OR FITNESS FOR A PARTICULAR PURPOSE. NO WARRANTY OR GUARANTEE GIVEN BY ANY PERSON, FIRM, OR CORPORATION WITH RESPECT TO THIS PRODUCT SHALL BE BINDING ON SAMSUNG. SAMSUNG SHALL NOT BE LIABLE FOR LOSS OF REVENUE OR PROFITS, FAILURE TO REALIZE SAVINGS OR OTHER BENEFITS, OR ANY OTHER GENERAL, INDIRECT, SPECIAL, INCIDENTAL, OR CONSEQUENTIAL DAMAGES CAUSED BY THE USE, MISUSE, OR INABILITY TO USE THIS PRODUCT, REGARDLESS OF THE LEGAL THEORY ON WHICH THE CLAIM IS BASED, AND EVEN IF SAMSUNG HAS BEEN ADVISED OF THE POSSIBILITY OF SUCH DAMAGES. NOR SHALL RECOVERY OF ANY KIND AGAINST SAMSUNG BE GREATER IN AMOUNT THAN THE PURCHASE PRICE OF THE PRODUCT SOLD BY SAMSUNG AND CAUSING THE ALLEGED DAMAGE. WITHOUT LIMITING THE FOREGOING, PURCHASER ASSUMES ALL RISK AND LIABILITY FOR LOSS, DAMAGE, OR INJURY TO PURCHASER AND PURCHASER'S PROPERTY AND TO OTHERS AND THEIR PROPERTY ARISING OUT OF THE USE, MISUSE, OR INABILITY TO USE THIS PRODUCT. THIS LIMITED WARRANTY SHALL NOT EXTEND TO ANYONE OTHER THAN THE ORIGINAL PURCHASER OF THIS PRODUCT, IS NONTRANSFERABLE, AND STATES YOUR EXCLUSIVE REMEDY.

Some states or provinces do not allow limitations on how long an implied warranty lasts, or the exclusion or limitation of incidental or consequential damages, so the above limitations or exclusions may not apply to you.

This warranty gives you specific legal rights, and you may also have other rights which vary from state to state or province to province.

To obtain warranty service, please contact SAMSUNG at:

Samsung Electronics Canada Inc.
2050 Derry Road West, Mississauga, Ontario L5N 0B9 Canada
1-800-SAMSUNG (726-7864) and www.samsung.com/ca/support (English)
www.samsung.com/ca_fr/support (French)





Registration

Please register your product online at www.samsung.com/register.

Questions

For questions about features, operation/performance, parts, accessories, or service, call 1-800-SAMSUNG (726-7864), or visit our Web site at www.samsung.com/ca/support (English), or www.samsung.com/ca_fr/support (French).

Model # _____ Serial # _____

Please attach your receipt (or a copy) to this manual. You may need it, along with your model and serial number, when calling for assistance.

Open Source Announcement (NX58*665*** only)

The software included in this product contains open source software. You may obtain the complete corresponding source code for a period of three years after the last shipment of this product by sending an email to <mailto:oss.request@samsung.com>.

It is also possible to obtain the complete corresponding source code in a physical medium such as a CD-ROM; a minimal charge will be required.

The following URL http://opensource.samsung.com/opensource/SMART_AT_051/seq/0 leads to the download page of the source code made available and open source license information as related to this product. This offer is valid to anyone in receipt of this information.





SAMSUNG



Scan this with your smartphone

Scan the QR code* or visit
www.samsung.com/spsn
to view our helpful
How-to Videos and Live Shows

* Requires reader to be installed on your
smartphone

Please be advised that the Samsung warranty does NOT cover service calls to explain product operation, correct improper installation, or perform normal cleaning or maintenance.

QUESTIONS OR COMMENTS?

COUNTRY	CALL	OR VISIT US ONLINE AT
U.S.A Consumer Electronics	1-800-SAMSUNG (726-7864)	www.samsung.com/us/support
CANADA	1-800-SAMSUNG (726-7864)	www.samsung.com/ca/support (English) www.samsung.com/ca_fr/support (French)



DG68-00993A-04

