

Operating and installation instructions Gourmet warming drawer

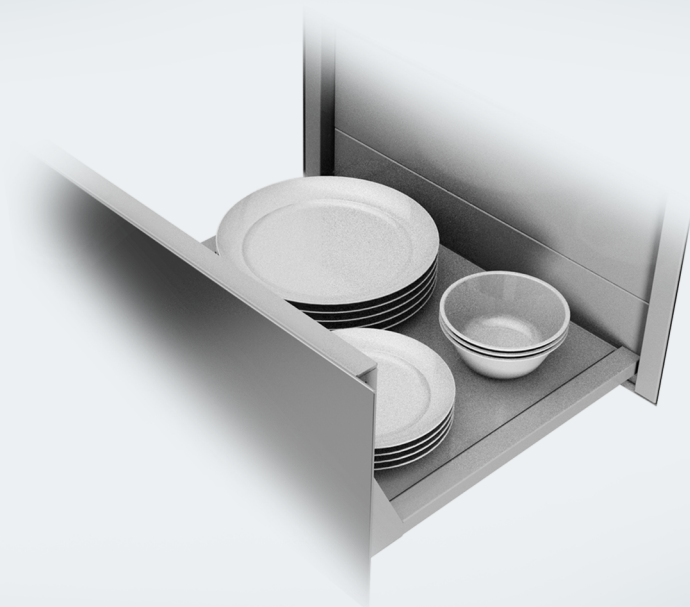

To avoid the risk of accidents or damage to the appliance it is **essential** to read these instructions before it is installed and used for the first time.

Contents

Warning and Safety instructions	4
Caring for the environment	11
Guide to the appliance	12
ESW 7010, ESW 7110.....	12
ESW 7020, ESW 7030, ESW 7120.....	13
Controls and indicators	14
Accessories supplied	15
Before using for the first time	16
Cleaning the drawer for the first time.....	16
Heating up the drawer for the first time	16
Miele@home.....	17
Operation	20
Using the appliance.....	20
Using MobileStart.....	21
Operating modes.....	21
Duration.....	21
Temperature settings.....	22
Keeping food warm	23
Warming crockery	26
Heating up times	26
Capacity	26
ESW 7010, ESW 7110.....	27
ESW 7020, ESW 7030, ESW 7120.....	28
Low temperature cooking	29
Other uses	34
Networking with Miele built-in appliances	35
Sabbath mode	36
Cleaning and care	37
Problem solving guide	39
Optional accessories	41
After sales service	42
Contact in the event of a fault.....	42
Data plate	42

Warranty	42
Installation	43
Safety instructions for installation	43
Installation notes	44
Installation dimensions ESW 7010, ESW 7110	45
Combination appliance for niches with a height of 450 mm	45
Combination appliance for niches with a height of 590 mm	46
Side view	47
Connections and ventilation	48
Installation dimensions ESW 7020, ESW 7120	49
Combination appliance for niches with a height of 450 mm	49
Combination appliance for niches with a height of 590 mm	50
Side view	51
Connections and ventilation	52
Installation dimensions ESW 7030	53
Combination appliance for niches with a height of 450 mm	53
Combination appliance for niches with a height of 590 mm	54
Side view	55
Connections and ventilation	56
Installation	57
Electrical connection	58
EU Conformity declaration	60
UK Conformity declaration	61

Warning and Safety instructions

Please note that the Gourmet drawer is referred to in these operating instructions as the drawer.

This drawer complies with all current local and national safety requirements. Inappropriate use can, however, lead to personal injury and material damage.

Read the operating and installation instructions carefully before using the drawer. They contain important information on safety, installation, use and maintenance. This prevents both personal injury and damage to the drawer.

In accordance with standard IEC 60335-1, Miele expressly and strongly advises that you read and follow the instructions in the chapter on installing the drawer as well as the safety notes and warnings.

Miele cannot be held liable for injury or damage caused by non-compliance with these instructions.

Keep these operating and installation instructions in a safe place and pass them on to any future owner.

Correct application

- ▶ The drawer is intended for domestic use and use in other similar environments.
- ▶ The drawer is not intended for outdoor use.
- ▶ It is intended for domestic use only as described in these operating instructions. Any other usage is not supported by the manufacturer and could be dangerous.
- ▶ People with reduced physical, sensory or mental capabilities, or lack of experience and knowledge who are not able to use the drawer safely on their own must be supervised whilst using it. They may only use it unsupervised if they have been shown how to use it safely and recognise and understand the consequences of incorrect operation.

Warning and Safety instructions

Safety with children

- ▶ Children under the age of 8 years must be kept away from the drawer unless they are constantly supervised.
- ▶ Children aged 8 and older may only use the drawer without supervision if they have been shown how to use it and are able to do so in a safe manner. Children must be able to understand and recognise the possible dangers caused by incorrect operation.
- ▶ Children must not be allowed to clean the drawer unsupervised.
- ▶ Please supervise children in the vicinity of the drawer, and do not let them play with it.
- ▶ The drawer gets hot when in use and remains hot for quite a while after being switched off. Keep children away from the drawer until it has cooled down and there is no danger of burning.
- ▶ Danger of suffocation! Whilst playing, children may become entangled in packaging material (such as plastic wrapping) or pull it over their head with the risk of suffocation. Keep packaging material away from children.

Technical safety

- ▶ Unauthorised installation, maintenance and repairs can cause considerable danger for the user. Installation, maintenance and repairs must only be carried out by a Miele authorised technician.
- ▶ A damaged drawer can be dangerous. Always check for visible signs of damage. Never use a damaged appliance.
- ▶ Reliable and safe operation of the drawer can only be assured if it has been connected to the mains electrical supply.
- ▶ The electrical safety of this drawer can only be guaranteed when correctly earthed. It is essential that this standard safety requirement is met. If in any doubt please have the electrical installation tested by a qualified electrician.
- ▶ The connection data (voltage and frequency) on the data plate of the drawer must match the mains electricity supply in order to avoid the risk of damage to the drawer.
Compare this data before connecting the appliance. If in any doubt, consult a qualified electrician.
- ▶ Do not connect the drawer to the mains electrical supply by a multi-socket adapter or extension lead. These are a fire hazard and do not guarantee the required safety of the appliance.
- ▶ For safety reasons, this drawer may only be used when it has been built in.
- ▶ This drawer must not be used in a non-stationary location (e.g. on a ship).
- ▶ Never open the casing of the drawer.
Touching or tampering with electrical connections or components and mechanical parts is highly dangerous to the user and can cause operational faults.

Warning and Safety instructions

- ▶ While the appliance is under warranty, repairs should only be undertaken by a Miele authorised service technician. Otherwise the warranty is invalidated.
- ▶ Miele can only guarantee the safety of the appliance when genuine original Miele replacement parts are used. Faulty components must only be replaced by Miele spare parts.
- ▶ If the plug is removed from the connection cable or if the cable is supplied without a plug, the drawer must be connected to the electrical supply by a suitably qualified electrician.
- ▶ If the mains connection cable is damaged, it must be replaced with a special mains connection cable (see “Electrical connection” in the “Installation” chapter).
- ▶ During installation, maintenance and repair work, the drawer must be disconnected from the mains electricity supply.
- ▶ If the drawer is installed behind a furniture panel (e.g. a door), ensure that the door is never closed whilst the drawer is in use. Heat and moisture can build up behind a closed furniture panel and cause subsequent damage to the drawer, the housing unit and the floor. Do not close the door until the drawer has cooled down completely.

Correct use

- ▶ You could burn yourself on the hot drawer or hot dishes. Protect your hands with heat-resistant pot holders or gloves when handling hot appliances. Do not let them get wet or damp. Heat transfers through damp and wet material more quickly with the risk of scalding or burning yourself.
- ▶ Fire hazard. Do not store any plastic containers or combustible objects in the warming drawer. They can melt or catch fire when the appliance is switched on.
- ▶ Due to the high temperatures, objects left near the warming drawer when it is switched on could catch fire. Do not use the warming drawer to heat up the room.
- ▶ Never replace the anti-slip mat supplied with the appliance with paper kitchen towel or similar.
- ▶ The telescopic runners can support a maximum load of 25 kg. Overloading or leaning or sitting on the drawer will damage the telescopic runners.
- ▶ The underside of the warming drawer gets hot when switched on. Be careful not to touch it when the drawer is open.
- ▶ The anti-slip mat is heat-resistant up to 200 °C. It is possible for the bottom of pots and pans to exceed this temperature, especially after they have been used to sear food. Allow pots and pans to cool down for a minute or two before placing them in the drawer.
- ▶ Cookware made of plastic or aluminium foil will melt at high temperatures. When keeping food warm, use only heat-resistant cookware made of porcelain, glass, etc.
- ▶ Liquids that get inside the drawer can cause the appliance to short-circuit. Open and close a loaded drawer carefully to prevent liquids from spilling.

Warning and Safety instructions

- ▶ The Keeping food warm  function is designed to keep hot food warm and not to warm up cold food. Ensure food is really hot when placed inside the drawer.
- ▶ Bacteria can develop on the food if the temperature is too low. Make sure that you set a high enough temperature to keep food warm.

Cleaning and care

- ▶ Danger of electric shock. The steam from a steam cleaning appliance could reach live electrical components and cause a short circuit. Do not use a steam cleaner to clean the warming drawer.

Disposal of the packing material

The packaging is designed to protect the appliance from damage during transportation. The packaging materials used are selected from materials which are environmentally friendly for disposal and should be recycled.

Recycling the packaging reduces the use of raw materials in the manufacturing process and also reduces the amount of waste in landfill sites.

Disposing of your old appliance

Electrical and electronic appliances often contain valuable materials. They also contain specific materials, compounds and components, which were essential for their correct function and safety. These could be hazardous to human health and to the environment if disposed of with your domestic waste or if handled incorrectly. Please do not, therefore, dispose of your old appliance with your household waste.



Please dispose of it at your local community waste collection / recycling centre for electrical and electronic appliances, or contact your dealer or Miele for advice. You are also responsible for deleting any personal data that may be stored on the appliance being disposed of. Please ensure that your old appliance poses no risk to children while being stored prior to disposal.

Guide to the appliance

ESW 7010, ESW 7110

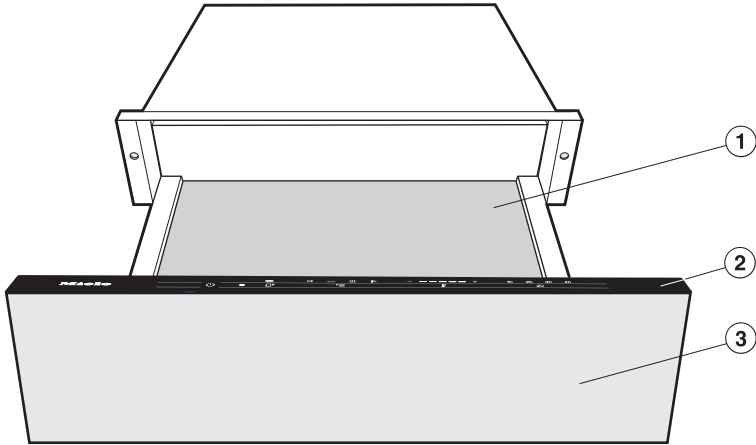

- ① Anti-slip mat
- ② Controls and indicators
- ③ Drawer front with Push2open mechanism
The drawer can be opened and closed by lightly pressing the drawer front.

ESW 7020, ESW 7030, ESW 7120

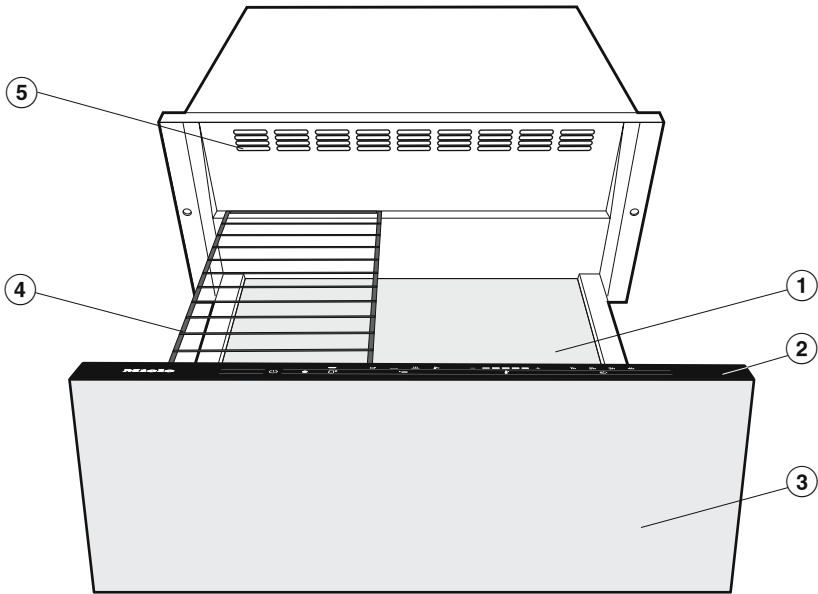

- ① Anti-slip mat
- ② Controls and indicators
- ③ Drawer front with Push2open mechanism
The drawer can be opened and closed by lightly pressing the drawer front.
- ④ Wire rack
- ⑤ Air vents

Guide to the appliance

Controls and indicators

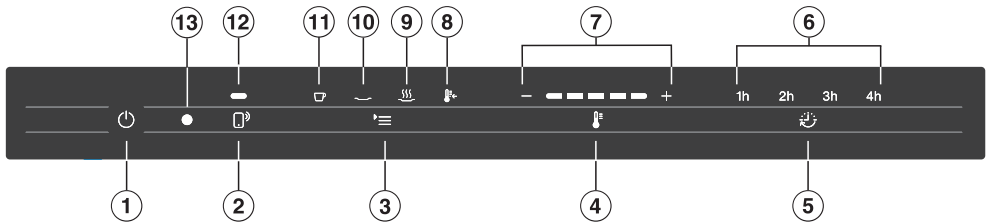

Sensor controls

- ① On/Off sensor control For switching the drawer on/off
- ② Sensor control For controlling the drawer via your mobile device
- ③ Sensor control For selecting the operating mode
- ④ Sensor control For setting the temperature
- ⑤ Sensor control For setting a limited duration or re-setting continuous operation.

Indicator lights

- ⑥ Indicators for the selected duration
1 h = 1 hour
2 h = 2 hours
3 h = 3 hours
4 h = 4 hours
No lights = Continuous operation
- ⑦ Segment bar indicator lights
For displaying the temperature
- ⑧ Indicator light Indicates that the low temperature cooking operating mode is set.
- ⑨ Indicator light Indicates that the keeping food warm operating mode is set.
- ⑩ Indicator light Indicates that the plates/dishes operating mode is set.
- ⑪ Indicator light Indicates that the cups/glasses operating mode is set.
- ⑫ Indicator light Indicates that the function for controlling the drawer via your mobile device is activated.
- ⑬ Optical interface
(For Miele Service only)

Accessories supplied

The accessories supplied with your appliance as well as a range of optional ones are available to order from Miele (see “Optional accessories”).

Wire rack

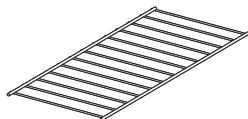

For increasing the loading area (ESW 7020, ESW 7030, ESW 7120).

Anti-slip mat

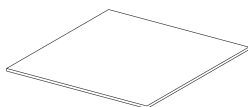

For keeping dishes secure.

Cookery book for low temperature cooking

A selection of the best recipes from the Miele test kitchen.

Before using for the first time

- Remove any protective wrapping and stickers.
- Do not remove stickers carrying safety or installation information or the data plate.





This makes it easier to perform servicing and repair work.

Cleaning the drawer for the first time

- Remove the anti-slip mat and (if present) the wire rack from the drawer. Clean both with a clean sponge and a solution of hot water and washing-up liquid or a damp microfibre cloth.
- Dry the anti-slip mat and the rack with a soft cloth.
- Wipe the drawer inside and out with a damp cloth to remove any dust or left-over packaging.
- Dry all surfaces with a soft cloth.
- Replace the anti-slip mat and the rack (if applicable) in the drawer.

Heating up the drawer for the first time

Heat the empty drawer for at least 2 hours.

- Touch the  sensor to switch the drawer on.
- Touch the  sensor repeatedly until the  symbol lights up.
- Touch the  sensor repeatedly until the segment on the far right-hand side of the temperature display lights up.
- Touch the  sensor repeatedly until **2 h** lights up.
- Close the drawer.

The drawer is fitted with a contact switch. This ensures that the heating element and fan in the appliance only work when the drawer is closed.

The drawer will switch itself off automatically after 2 hours.

The metal components have a protective coating. For that reason they will give off a slight smell temporarily when the drawer is heated for the first time. The smell and any vapours given off will dissipate after a short time, and do not indicate a faulty connection or appliance.

It is important to ensure that the kitchen is well ventilated when heating the drawer for the first time.

Before using for the first time

Miele@home

Your drawer is equipped with an integrated WiFi module.

To use this feature, you will need:

- A WiFi network
- The Miele app
- A Miele user account The user account can be created via the Miele app.

The Miele app will guide you as you connect your drawer to your home WiFi network.

Once your drawer is connected to your WiFi network, you can use the app, for example, to carry the following activities:

- Access information about the operating status of your drawer
- Retrieve information on cooking processes that are in progress
- Stop cooking processes that are in progress

The drawer requires max. 2 W in networked standby.

Before installing the drawer in its installation site, ensure that the signal of your WiFi network is strong enough.

Availability of the WiFi connection

The WiFi connection shares a frequency range with other appliances (including microwave ovens and remote control toys). This can give rise to sporadic or even complete connection failures. Therefore, the availability of featured functions cannot be guaranteed.

Miele@home availability

The ability to use the Miele app depends on the availability of the Miele@home service in your country.

The Miele@home service is not available in every country.

For information about availability, please visit www.miele.com.

Miele App

The Miele App is available to download free of charge from the Apple App Store® or from the Google Play Store™.



Before using for the first time

Connecting via the app

The Miele@mobile app can be used to connect to your network.

- Install the Miele@mobile app on your mobile device.

To log in you will need:

1. your WiFi network password
2. your drawer password

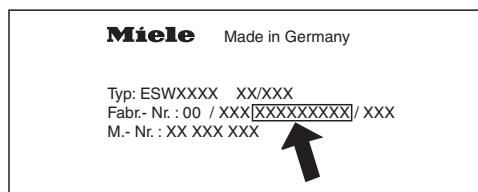

The password for your drawer consists of the last nine digits of the serial number. This can be found on the appliance's data plate.

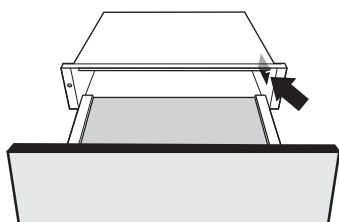

Data plate

The data plate is located here:



- Start signing the appliance on in the app. Follow the signing-on instructions.

If requested to activate the WiFi on the drawer, proceed as follows:

- Switch the drawer off.
- Press and hold the  sensor control.
- At the same time, touch the  sensor control.

2 h will light up constantly, **3 h** will flash on and off.

The drawer will be ready for connection in the next 10 minutes.

- Follow the instructions in the app.

When successfully connected, **2 h** and **3 h** will light up constantly.



- Quit the connection mode on the drawer by touching the  sensor control.

The drawer can now be operated via the app.

Before using for the first time

Connecting via WPS

Your WiFi router must support WPS (WiFi Protected Setup).

- Switch the drawer off.
- Press and hold the  sensor control.
- At the same time, touch the  sensor control.

2 h will light up constantly, **3 h** will flash on and off.

The WPS connection must be started on the drawer at the same time as on the WiFi router.

- Touch the  sensor control on the drawer after a few seconds.

After a short while, **2 h** will light up constantly, and **3 h** and **4 h** will flash on and off.

The drawer will be ready for connection in the next 10 minutes.

- Start the WPS connection on your WiFi router.

When successfully connected, **2 h** and **3 h** will light up constantly.

- Quit the connection mode on the drawer by touching the  sensor control.



The drawer can now be operated via the app.

If the connection fails, you have probably not activated WPS on your router quickly enough. Repeat the steps above.

Tip: If your WiFi router does not support WPS, please connect via the Miele@mobile app.

Signing out of WiFi (resetting factory defaults)

To set up a new WiFi connection, the existing WiFi connection must be disconnected.

- Switch the drawer off.
- Press and hold the  sensor control.
- At the same time, touch the  sensor control.

With an existing WiFi connection, **2 h** and **3 h** will light up constantly.

The drawer will be ready for disconnection in the next 10 minutes.

- Touch the  sensor control.

2 h will light up constantly, **3 h** will flash on and off.

After a few seconds, **2 h** and **3 h** will start flashing on and off. The connection has now been disconnected.

- Quit the signing off mode on the drawer by touching the  sensor control.

The WiFi connection has now been disconnected. A new connection can now be set up.

Log off the WiFi if you are disposing of your drawer, selling it or putting a used drawer into operation. This is the only way to ensure that all personal data has been removed and the previous owner will no longer be able to access the drawer.

Operation

Using the appliance

 Malfunction due to dirty and/or covered sensor controls.

The sensor controls do not react or unintentional switching procedures result, perhaps even the automatic deactivation of the drawer.





Keep the sensor controls and indicators clean.

Do not place anything over the sensor controls or indicators.

 Damage caused by liquids.

Liquids that get inside the drawer can cause a short circuit.

Open and close a loaded drawer carefully to prevent liquids from spilling.

- Open the drawer.
- Touch the  sensor control to switch the drawer on.
- Touch the  sensor control repeatedly until the required operating mode lights up.
- Touch the  sensor control repeatedly until the segment for the required temperature lights up in the temperature display.
- Touch the  sensor control repeatedly until the required number of hours for the operating duration lights up.
- Close the drawer.

Using MobileStart





- Touch the  sensor to activate MobileStart.

The indicator light above the  sensor will light up. You will then be able to operate the drawer via the Miele@mobile app.

Operation via the sensors has precedence over operation via the app.

Operating modes

The following operating modes are available:

-  Warming cups/glasses
-  Warming dishes/plates
-  Keeping food warm
-  Low temperature cooking

The last operating mode selected is automatically activated the next time the drawer is switched on, and this is shown in the control panel.

The drawer is equipped with a fan which distributes the warmed air within the drawer. The fan runs continuously in all operating modes.

The drawer can be used to keep food warm at the same time as warming plates and dishes. Use the  “Keeping food warm” operating mode for this.

 Danger of burning from hot dishes.

Empty dishes will become very hot when heated using the  “Keeping food warm” operating mode.

Use oven gloves when removing the dishes.

Duration

 Fire hazard due to dried-out food.

Long warming times result in the food drying out, which may cause it to catch fire.

Do not leave the drawer unattended for long periods in operation.

The drawer is set for continuous operation mode (exception: low temperature cooking). The safety cut-out switch will switch off the drawer after a maximum of 12 hours of continuous operation.

A limited operating duration can be selected by touching the  sensor. One touch for 1 hour (1 h), two touches for 2 hours (2 h), etc., up to a maximum of 4 hours.









Continuous operation is restored by touching the sensor a fifth time.

Operation

Temperature settings

A temperature range is assigned to each operating mode. The factory set recommended temperatures are shown in bold. The temperature can be altered in 5 °C increments by touching the  sensor.

The last temperature selected is automatically activated the next time the drawer is switched on, and this is shown in the control panel (exception: low temperature cooking).

Temperature display	Temperature [°C] *			
				
	40	60	65	65
	45	65	70	70
	50	70	75	75
	55	75	80	80
	60	80	85	85

* Approximate temperature values, measured in the middle of the drawer when empty

Tips

To maintain your food's optimum quality please note the following:

- Place the hot food in pre-heated dishes. To pre-heat dishes, place them in the drawer while it is heating up.
- Do not cover roast or fried food which you want to keep crisp. These types of food need to be kept warm at a higher temperature.
- Cover liquids and food with a high moisture content with a suitable lid or heat-resistant foil to prevent moisture escaping and condensing outside the dish.
- To avoid spillages, do not overfill dishes.
- Freshly cooked food is hotter than food which is being kept warm. Serve the food on pre-warmed plates.
- Nutrients are lost when food is cooked, and continue to diminish when food is kept warm. The longer food is kept warm, the greater the loss of nutrients.
- We do not recommend food being kept warm for too long, as it will continue to cook.
- Food may cool down if the drawer is opened and closed too often.
- Do not open the drawer too quickly or slam it shut. Liquids could spill over and get into the vents or into the inner parts of the drawer.

Keeping food warm

 Health risk caused by using too low a temperature.

Bacteria may develop in the food if the temperature used for keeping food warm is too low.

Only use the  “Keeping food warm” operating mode.

This operating mode is for keeping food warm which has just been cooked and is still hot. It is not for reheating food that has gone cold.

- Select the  “Keeping food warm” operating mode.
- Select the desired duration.

Pre-heat the drawer for approx. 15 minutes to ensure that the interior has reached the required minimum temperature.

- Whilst the appliance is heating up, place the empty dishes in the drawer.
- Remove the pre-heated dishes from the drawer after 15 minutes and fill them with the hot food. Wear oven gloves when removing dishes from the drawer.
- Then place the dishes in the drawer and close it carefully to prevent any liquids from spilling.

Settings

Food	Dishes	Cover dish	Temperature for the  setting	Position	
				Floor	Wire rack*
Steak rare	Plate	No	<input checked="" type="checkbox"/> <input type="checkbox"/> <input type="checkbox"/> <input type="checkbox"/> <input type="checkbox"/> <input type="checkbox"/>	x	x
Bakes/gratin	Gratin dish	Yes	<input type="checkbox"/> <input type="checkbox"/> <input type="checkbox"/> <input checked="" type="checkbox"/> <input type="checkbox"/> <input type="checkbox"/>	x	
Roast meat	Plate	Yes	<input type="checkbox"/> <input type="checkbox"/> <input checked="" type="checkbox"/> <input type="checkbox"/> <input type="checkbox"/> <input type="checkbox"/>	x	
Stew	Dish	Yes	<input type="checkbox"/> <input type="checkbox"/> <input type="checkbox"/> <input checked="" type="checkbox"/> <input type="checkbox"/> <input type="checkbox"/>	x	
Fish fingers	Dish	No	<input type="checkbox"/> <input type="checkbox"/> <input type="checkbox"/> <input type="checkbox"/> <input checked="" type="checkbox"/> <input type="checkbox"/>	x	
Meat in a sauce	Dish	Yes	<input type="checkbox"/> <input type="checkbox"/> <input type="checkbox"/> <input checked="" type="checkbox"/> <input type="checkbox"/> <input type="checkbox"/>	x	
Vegetables in a sauce	Dish	Yes	<input type="checkbox"/> <input type="checkbox"/> <input type="checkbox"/> <input checked="" type="checkbox"/> <input type="checkbox"/> <input type="checkbox"/>	x	
Goulash	Dish	Yes	<input type="checkbox"/> <input type="checkbox"/> <input type="checkbox"/> <input checked="" type="checkbox"/> <input type="checkbox"/> <input type="checkbox"/>	x	
Mashed potato	Dish	Yes	<input type="checkbox"/> <input type="checkbox"/> <input checked="" type="checkbox"/> <input type="checkbox"/> <input type="checkbox"/> <input type="checkbox"/>	x	
Plated meal	Plate	Yes	<input type="checkbox"/> <input type="checkbox"/> <input type="checkbox"/> <input checked="" type="checkbox"/> <input type="checkbox"/> <input type="checkbox"/>	x	
Baked potatoes/new potatoes	Plate/dish	Yes	<input type="checkbox"/> <input type="checkbox"/> <input checked="" type="checkbox"/> <input type="checkbox"/> <input type="checkbox"/> <input type="checkbox"/>	x	
Breaded escalope	Dish	No	<input type="checkbox"/> <input type="checkbox"/> <input type="checkbox"/> <input type="checkbox"/> <input type="checkbox"/> <input checked="" type="checkbox"/>	x	
Pancakes/potato cakes	Plate	No	<input type="checkbox"/> <input type="checkbox"/> <input type="checkbox"/> <input type="checkbox"/> <input checked="" type="checkbox"/> <input type="checkbox"/>	x	x
Pizza	Plate	No	<input type="checkbox"/> <input type="checkbox"/> <input type="checkbox"/> <input type="checkbox"/> <input type="checkbox"/> <input checked="" type="checkbox"/>	x	
Boiled potatoes	Dish	Yes	<input type="checkbox"/> <input type="checkbox"/> <input type="checkbox"/> <input checked="" type="checkbox"/> <input type="checkbox"/> <input type="checkbox"/>	x	
Sauce	Dish	Yes	<input type="checkbox"/> <input type="checkbox"/> <input type="checkbox"/> <input checked="" type="checkbox"/> <input type="checkbox"/> <input type="checkbox"/>	x	
Strudel	Plate	No	<input type="checkbox"/> <input type="checkbox"/> <input type="checkbox"/> <input checked="" type="checkbox"/> <input type="checkbox"/> <input type="checkbox"/>	x	
To warm white bread	-	No	<input checked="" type="checkbox"/> <input type="checkbox"/> <input type="checkbox"/> <input type="checkbox"/> <input type="checkbox"/> <input type="checkbox"/>	x	x
To warm rolls	-	No	<input checked="" type="checkbox"/> <input type="checkbox"/> <input type="checkbox"/> <input type="checkbox"/> <input type="checkbox"/> <input type="checkbox"/>	x	x

* Depending on model

Warming crockery

Tips

- Spread the dishes out across the whole surface if possible. Tall stacks of plates will not warm up as rapidly as individual dishes. If you cannot avoid stacking plates, place these at the front of the drawer. Use the wire rack (depending on model).
- Do not place large serving dishes right up against the vents. They will cover the warm air outlets. The dishes will not heat up evenly.
- For cups and glasses, only select the  “Warming cups/glasses” operating mode to ensure that the maximum temperature (60 °C) is not exceeded.
- Heated dishes cool down very quickly. For that reason you should not remove it from the drawer until just before you need it.

Heating up times

Various factors will affect the heating up times:

- The material and thickness of the dishes
- Load size
- How the load is arranged
- Temperature selection

It is therefore not possible to state precise times. For even heating with the  “Warming dishes/plates” operating mode, the following values can be used as a guide:

- 30–35 minutes for 6 place settings to heat up evenly
- 40–45 minutes for 12 place settings to heat up evenly

As you use the appliance, you will get to know which settings suit your own needs best.

Capacity

 Risk of damage due to overloading.

Overloading the drawer will damage the telescopic runners.

The maximum load bearing capacity of the drawer is **25 kg**.

The capacity will depend to a great extent on the size and weight of your dishes.

ESW 7020, ESW 7030, ESW 7120: the loading area can be increased by using the wire rack supplied with the drawer. The wire rack can be used in a variety of ways. You can also increase the loading area using 2 wire racks positioned on the left and right. An additional wire rack is available to order via the Miele webshop, the Miele Customer Service Department or from your Miele dealer (see “Optional accessories”).

ESW 7010, ESW 7110

The loading examples shown here are suggestions only:

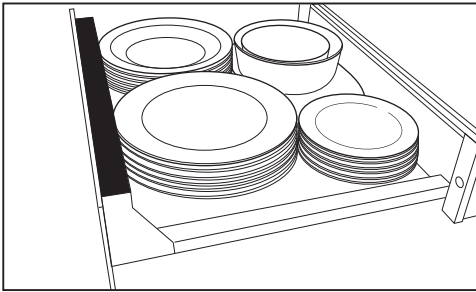

6 place settings

6 dinner plates	Ø 26 cm
6 soup bowls	Ø 23 cm
6 dessert plates	Ø 19 cm
1 oval serving dish	32 cm
1 serving dish	Ø 16 cm
1 serving dish	Ø 13 cm

or alternatively

12 dinner plates	Ø 26 cm
18 soup bowls	Ø 23 cm
16 soup cups	Ø 10 cm
6 dinner plates and 6 soup bowls	Ø 26 cm Ø 23 cm
6 pizza plates	Ø 36 cm
72 espresso cups	Ø 5.9 cm
30 cappuccino cups	Ø 8.8 cm
30 punch glasses	Ø 6.7 cm (8 cm tall)

Warming crockery

ESW 7020, ESW 7030, ESW 7120

The loading examples shown here are suggestions only:

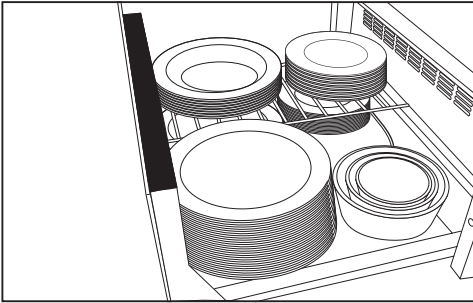

12 place settings

12 dinner plates	Ø 26 cm
12 soup bowls	Ø 23 cm
12 dessert plates	Ø 19 cm
1 oval serving dish	32 cm
1 serving dish	Ø 19 cm
1 serving dish	Ø 16 cm
1 serving dish	Ø 13 cm

or alternatively

40 dinner plates	Ø 26 cm
60 soup bowls	Ø 23 cm
45 soup cups	Ø 10 cm
20 dinner plates	Ø 26 cm
20 soup bowls	Ø 23 cm
20 pizza plates	Ø 36 cm
142 espresso cups	Ø 5.9 cm
90 cappuccino cups	Ø 8.8 cm
30 punch glasses	Ø 6.7 cm (8 cm tall)

With low temperature cooking, food is cooked at a low temperature over a long period of time. Using this method, food loses less liquid as it is cooked gently and so remains succulent and tender.

If food probes from other Miele built-in appliances are used in the drawer, they may affect the built-in appliances.

Only use the Miele built-in appliance food probe with the built-in appliance that it was supplied with.

For precision, we recommend using a proprietary food probe to monitor the core temperature. The food can then be cooked with pinpoint accuracy.

Core temperature

Food can be cooked to a core temperature of up to 70 °C in the drawer. Food which needs to be cooked to a core temperature higher than 70 °C is not suitable for cooking in the drawer.

The core temperature reading gives information about the degree of cooking in the middle of the food.

For meat, the lower the core temperature, the less cooked the meat is in the middle:

- 45–50 °C = rare
- 55–60 °C = medium
- 65 °C = well done

Cooking duration

The cooking duration depends on the size of the food, and can be between 1 and 6 hours.

Pre-heat the drawer with the suitable cooking containers for 15 minutes. This ensures that the dishes and the interior of the drawer reach the required temperature.

Example:

Selected duration: 1 h

Actual operating time: 1 hour
15 minutes

Notes

- Use meat that has been properly hung.
- The quality of the food is of vital importance for a good result.
- The food must be at room temperature. Take it out of the fridge about 15 minutes before cooking.

Low temperature cooking

Using the low temperature cooking operating mode

- Select the low temperature cooking  operating mode.
- Place the heat-resistant dish in the bottom of the drawer.

The drawer will pre-heat automatically for 15 minutes and then operate at the pre-set temperature of 85 °C for a pre-set duration of 4 h.

If you wish to cook on a different setting, please consult the cooking charts on the following pages.

- If necessary, select the desired temperature.
- If necessary, select the desired duration.
- After pre-heating, put the food in the dish.
- If using a food probe:
Push the food probe into the food so that the tip is in the centre. Make sure that it does not come into contact with bones or layers of fat as these can cause a false reading.
- When the temperature is approx. 10 °C (guide value) below the core temperature given in the cooking chart, remove the food from the warming drawer.

A smaller temperature difference is recommended for large portions of food.

- Sear the food on all sides over a high heat on the hob.

Tips

- Do not cook the food all the way through. Sear the food again after cooking.
- The food can be sliced straight away. It does not need to rest.
- Serve the food on pre-heated plates to stop it cooling too quickly.





Low temperature cooking

Pre-heat the cooking container for 15 minutes. In this time, rest the food at room temperature.

Place the food into the pre-heated cooking container in the compartment.

The cooking durations given in the charts are guidelines only. The food can be cooked further if required.





Beef cooking chart

Type of cut	 [min]	 * [°C]	 [min]	
Medallions 3–4 cm thick	1 per side	45–50	45–60	<input type="checkbox"/> <input type="checkbox"/> <input checked="" type="checkbox"/> <input type="checkbox"/> <input type="checkbox"/>
	1–2 per side	55–60	65–80	<input type="checkbox"/> <input type="checkbox"/> <input type="checkbox"/> <input checked="" type="checkbox"/> <input type="checkbox"/>
	2 per side	65	95–110	<input type="checkbox"/> <input type="checkbox"/> <input type="checkbox"/> <input type="checkbox"/> <input checked="" type="checkbox"/>
Sirloin steak approx. 170 g	1 per side	45–50	45–60	<input type="checkbox"/> <input type="checkbox"/> <input checked="" type="checkbox"/> <input type="checkbox"/> <input type="checkbox"/>
	2 per side	55–60	65–80	<input type="checkbox"/> <input type="checkbox"/> <input type="checkbox"/> <input checked="" type="checkbox"/> <input type="checkbox"/>
	2 per side	65	95–110	<input type="checkbox"/> <input type="checkbox"/> <input type="checkbox"/> <input type="checkbox"/> <input checked="" type="checkbox"/>
Rump steak approx. 200 g	1 per side	45–50	35–45	<input type="checkbox"/> <input type="checkbox"/> <input checked="" type="checkbox"/> <input type="checkbox"/> <input type="checkbox"/>
	1–2 per side	55–60	45–60	<input type="checkbox"/> <input type="checkbox"/> <input type="checkbox"/> <input checked="" type="checkbox"/> <input type="checkbox"/>
	2 per side	65	95–110	<input type="checkbox"/> <input type="checkbox"/> <input type="checkbox"/> <input type="checkbox"/> <input checked="" type="checkbox"/>

* 45–50 °C rare, 55–60 °C medium, 65 °C well done

 Searing time,  Core temperature,  Cooking duration,  Temperature setting

Veal cooking chart





Type of cut	 [min]	 * [°C]	 [min]	
Medallions 3–4 cm thick	1 per side	45–50	40–55	<input type="checkbox"/> <input type="checkbox"/> <input checked="" type="checkbox"/> <input type="checkbox"/> <input type="checkbox"/>
	2 per side	55–60	60–75	<input type="checkbox"/> <input type="checkbox"/> <input type="checkbox"/> <input checked="" type="checkbox"/> <input type="checkbox"/>
	2 per side	65	90–105	<input type="checkbox"/> <input type="checkbox"/> <input type="checkbox"/> <input type="checkbox"/> <input checked="" type="checkbox"/>
Steak approx. 160 g 2 cm thick	1 per side	45–50	15–30	<input type="checkbox"/> <input type="checkbox"/> <input checked="" type="checkbox"/> <input type="checkbox"/> <input type="checkbox"/>
	2 per side	55–60	30–45	<input type="checkbox"/> <input type="checkbox"/> <input type="checkbox"/> <input checked="" type="checkbox"/> <input type="checkbox"/>
	2 per side	65	65–80	<input type="checkbox"/> <input type="checkbox"/> <input type="checkbox"/> <input type="checkbox"/> <input checked="" type="checkbox"/>

* 45–50 °C rare, 55–60 °C medium, 65 °C well done

 Searing time,  Core temperature,  Cooking duration,  Temperature setting

Low temperature cooking





Pork cooking chart

Type of cut	 [min]	 * [°C]	 [min]	 ←
Fillet approx. 550 g	6–8 total	65	90–110	<input type="checkbox"/> <input type="checkbox"/> <input type="checkbox"/> <input type="checkbox"/> <input checked="" type="checkbox"/>
Medallions approx. 4 cm thick	2 per side	65	85–100	<input type="checkbox"/> <input type="checkbox"/> <input type="checkbox"/> <input type="checkbox"/> <input checked="" type="checkbox"/>

* 65 °C well done

 Searing time,  Core temperature,  Cooking duration, ← Temperature setting



Lamb cooking chart

Type of cut	 [min]	 * [°C]	 [min]	 ←
Rack of lamb approx. 170 g	2–4	60	45–60	<input type="checkbox"/> <input type="checkbox"/> <input type="checkbox"/> <input checked="" type="checkbox"/> <input type="checkbox"/>
	2–4	65	85–100	<input type="checkbox"/> <input type="checkbox"/> <input type="checkbox"/> <input type="checkbox"/> <input checked="" type="checkbox"/>
Rack of lamb approx. 400 g	2–4	60	45–60	<input type="checkbox"/> <input type="checkbox"/> <input type="checkbox"/> <input checked="" type="checkbox"/> <input type="checkbox"/>
	2–4	65	85–100	<input type="checkbox"/> <input type="checkbox"/> <input type="checkbox"/> <input type="checkbox"/> <input checked="" type="checkbox"/>
French trim rack of lamb approx. 600 g	2 per side	60	45–60	<input type="checkbox"/> <input type="checkbox"/> <input type="checkbox"/> <input checked="" type="checkbox"/> <input type="checkbox"/>
	2 per side	65	95–110	<input type="checkbox"/> <input type="checkbox"/> <input type="checkbox"/> <input type="checkbox"/> <input checked="" type="checkbox"/>

* 60 °C medium, 65 °C well done

 Searing time,  Core temperature,  Cooking duration, ← Temperature setting

Game cooking chart





Type of cut	 [min]	 * [°C]	 [min]	 ←
Venison medallions 3–4 cm thick	2 per side	60	65–80	<input type="checkbox"/> <input type="checkbox"/> <input type="checkbox"/> <input type="checkbox"/> <input checked="" type="checkbox"/>
	2 per side	65	95–110	<input type="checkbox"/> <input type="checkbox"/> <input type="checkbox"/> <input type="checkbox"/> <input checked="" type="checkbox"/>
Saddle of roebuck off the bone approx. 800 g	2 per side	60	55–70	<input type="checkbox"/> <input type="checkbox"/> <input type="checkbox"/> <input type="checkbox"/> <input checked="" type="checkbox"/>
	2 per side	65	95–110	<input type="checkbox"/> <input type="checkbox"/> <input type="checkbox"/> <input type="checkbox"/> <input checked="" type="checkbox"/>

* 60 °C medium, 65 °C well done

 Searing time,  Core temperature,  Cooking duration, ← Temperature setting



Low temperature cooking

Fish cooking chart

Fish type	 [min]	 [°C]	 [min]	
Salmon 400 g	2 on the skin side	52	45–60	<input type="checkbox"/> <input type="checkbox"/> <input type="checkbox"/> <input type="checkbox"/> <input checked="" type="checkbox"/>
Trout (whole) approx. 350 g	2 per side	52	15–30	<input type="checkbox"/> <input type="checkbox"/> <input type="checkbox"/> <input type="checkbox"/> <input checked="" type="checkbox"/>
Cod/skrei 200 g	No searing	52	75–90	<input type="checkbox"/> <input type="checkbox"/> <input type="checkbox"/> <input type="checkbox"/> <input checked="" type="checkbox"/>
Sea bream (whole) approx. 480–500 g	2 per side	52	25–40	<input type="checkbox"/> <input type="checkbox"/> <input type="checkbox"/> <input type="checkbox"/> <input checked="" type="checkbox"/>
Sea bass (whole) approx. 480–500 g	2 per side	52	20–35	<input type="checkbox"/> <input type="checkbox"/> <input type="checkbox"/> <input type="checkbox"/> <input checked="" type="checkbox"/>

 Searing time,  Core temperature,  Cooking duration,  Temperature setting

Other uses

Food	Dishes	Cover the dish?			 [h:min]
Defrosting berries	Bowl / dish	No	■ □ □ □ □		12:50
Dissolving gelatine	Bowl	No	□ □ □ □ ■		12:15
Proving dough	Bowl	Yes, with plate		■ □ □ □ □	12:30
Making yoghurt	Yogurt jars with lids	-		□ ■ □ □ □	5:00
Rice pudding (to finish off the cooking process)	Dish	Yes, with lid	□ □ □ □ ■		12:40
Melt chocolate	Bowl	No	□ □ □ □ ■		12:20
Defrosting frozen vegetables	Bowl	No	□ □ ■ □ □		1:00

 Temperature setting /  Temperature setting /  Duration

Networking with Miele built-in appliances

Networking enables the drawer to operate automatically depending on the operational state of another Miele built-in appliance.

Example:

The drawer pre-heats dishes at the right time before or after using the networked built-in appliance.

Prerequisites

The following conditions must be met for networking the drawer with other built-in appliances:

- The drawer is connected to the household WiFi network via Miele@home.
- The other built-in appliance is connected to the household WiFi network via Miele@home.

Carrying out the networking

Networking is carried out via the Miele@mobile app as normal.



See “Before using for the first time – Setting up Miele@home” as well as the Miele@mobile app for detailed information about this function.

Operation via the sensor controls has precedence over operation via the app.

Sabbath mode

To comply with religious requirements, the drawer can be programmed for the duration of the Sabbath. This mode will be switched off automatically after about 72 hours and normal operation will resume. When this function is activated, the duration setting is deactivated and the sensor controls must be touched for longer than usual.

Activating Sabbath mode

- If necessary, switch the drawer off.
 - Press and hold the  sensor control.
 - At the same time, touch the  sensor control.
- 1 h, 2 h, 3 h and 4 h** will light up.
- Set the required operating mode and temperature.

Deactivating Sabbath mode

You can deactivate the Sabbath function before the time has expired.

- Press and hold the  sensor control.
- All displays switch off.
- The drawer is in normal mode again.

 Risk of damage due to moisture ingress.

The steam from a steam cleaning appliance could reach live electrical components and cause a short circuit.

Do not use a steam cleaner to clean the drawer.

All surfaces could be discoloured or damaged if unsuitable cleaning agents are used. All surfaces are susceptible to scratching. Scratches on glass can in some circumstances lead to breakage.

Remove all cleaning agent residues immediately.

Never use abrasive sponges or cleaning agents.

 Danger of burning from hot interior.

The interior of the drawer will be hot after use.

Allow the drawer to cool down to a safe temperature before cleaning.

- The drawer and accessories should be cleaned and dried after each use.

Unsuitable cleaning agents

To avoid damaging the surfaces, do not use:

- cleaning agents containing soda, ammonia, acids or chlorides
- cleaning agents containing descaling agents
- abrasive cleaning agents, e.g. powder cleaners and cream cleaners
- solvent-based cleaning agents
- stainless steel cleaners
- cleaning agents for glass ceramic hobs
- dishwasher cleaners
- oven cleaners or sprays
- glass cleaning agents
- hard, abrasive sponges and brushes, e.g. pot scourers
- sharp metal scrapers

Cleaning and care

Cleaning the drawer front and interior

 Malfunction due to dirty and/or covered sensor controls.

The sensor controls do not react or unintentional switching procedures result, perhaps even the automatic deactivation of the drawer.

Keep the sensor controls and indicators clean.

Do not place anything over the sensor controls or indicators.

- Remove all soiling with a clean sponge and a solution of hot water and washing-up liquid or a damp microfibre cloth.
- Wipe with clean water afterwards.
- After cleaning, wipe the surfaces dry using a soft cloth.

Cleaning the anti-slip mat

 Damage caused by incorrect cleaning.

Washing the anti-slip mat in a dishwasher or washing machine will damage it.

The anti-slip mat should only be cleaned by hand.

 Damage caused by incorrect drying.

Drying the anti-slip mat in an oven will damage it.

Never place it in the oven to dry.

- Remove the anti-slip mat from the drawer.
- Clean the anti-slip mat using a solution of hot water and a little washing-up liquid.
- Only dry the anti-slip mat using a soft cloth.
- Replace the anti-slip mat in the drawer only when it is completely dry.



Problem solving guide

Many malfunctions and faults that can occur in daily operation can be easily remedied. Time and money will be saved because a service call will not be needed.

The following guide may help you to find the reason for a malfunction or a fault, and to correct it.

Problem	Cause and remedy
The drawer does not heat up.	The appliance is not correctly plugged in and switched on at the power socket. <ul style="list-style-type: none"> ■ Insert the plug and switch on at the socket.
	The fuse has tripped. <ul style="list-style-type: none"> ■ Reset the trip switch in the fuse box or replace the fuse in the plug (see data plate for minimum fuse rating). If, after resetting/replacing the trip switch in the fuse box or the residual current protection device, the drawer will still not turn on, contact a qualified electrician or the Miele Customer Service Department.
Noises during operation	The noise is from the fan which circulates warm air for even heat distribution. This is not a fault.
The food is not hot enough.	The function for keeping food warm $\overline{\text{SS}}$ is not selected. <ul style="list-style-type: none"> ■ Select the correct function.
	The temperature setting is too low. <ul style="list-style-type: none"> ■ Select a higher temperature.
	The vents are covered up. <ul style="list-style-type: none"> ■ Ensure that the air can circulate freely.
The food is too hot.	The function for keeping food warm $\overline{\text{SS}}$ is not selected. <ul style="list-style-type: none"> ■ Select the correct function.
	The temperature setting is too high. <ul style="list-style-type: none"> ■ Select a lower temperature.

Problem solving guide

Problem	Cause and remedy
The dishes are not hot enough.	The  operating mode for warming plates/dishes was not selected. ■ Select the correct operating mode.
	The temperature setting is too low. ■ Select a higher temperature.
	The vents are covered up. ■ Make sure that the air can circulate.
	The dishes have not been allowed to heat up for a sufficiently long time. ■ The heating time for dishes is affected by a number of factors (see “Heating dishes”).
The dishes are too hot.	The  operating mode for warming plates/dishes or  cups/glasses was not selected. ■ Select the correct operating mode.
	The temperature setting is too high. ■ Select a lower temperature.
Abrasion marks on the top edge of the front panel.	Installing or removing an appliance above the drawer has caused abrasion marks. ■ Carefully remove the abrasion marks by rubbing the top edge with the abrasive side of a standard scouring pad.

Miele offer a comprehensive range of useful accessories as well as cleaning and conditioning products for your Miele appliances.

These products can be ordered through the Miele Webshop.

They can also be ordered from Miele (see end of this booklet for contact details) or from your Miele dealer.

Wire rack

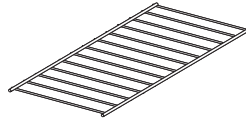

For increasing the loading area (ESW 7020, ESW 7030, ESW 7120).

Anti-slip mat

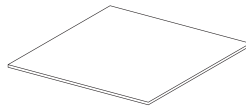

For keeping dishes secure.

Cover strip

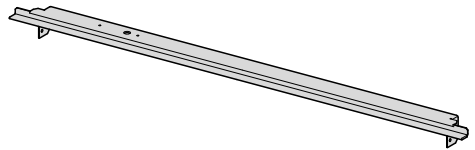

Covers the housing area between the drawer and the combination appliance above it.

Microfibre cloth

For removing finger marks and light soiling.

After sales service

Contact in the event of a fault

In the event of any faults which you cannot remedy yourself, please contact your Miele dealer or the Miele Customer Service Department.

You can book a Miele Customer Service Department call-out online at www.miele.com/service.

Contact information for the Miele Customer Service Department can be found at the end of this document.

Please quote the model identifier and serial number of your appliance (Fabr./SN/ Nr.) when contacting the Miele Customer Service Department. This information can be found on the data plate.

Please note that telephone calls may be monitored and recorded for training purposes and that a call-out charge will be applied to service visits where the problem could have been resolved as described in this booklet.

Data plate

The data plate is located here:

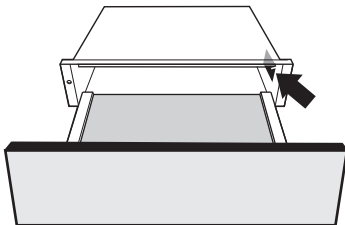

Warranty

For information on the appliance warranty specific to your country please contact Miele. See back cover for address.

In the UK, your appliance warranty is valid for 2 years from the date of purchase. However, you must activate your cover by calling 0330 160 6640 or registering online at www.miele.co.uk.

Safety instructions for installation



Risk of damage from incorrect installation.

Incorrect installation can cause damage to the drawer and/or the combination appliance.

The appliance must only be installed by a qualified person.

- ▶ The socket and on-off switch should be easily accessible after the drawer has been installed.
- ▶ The drawer may only be built in in combination with those appliances quoted by Miele as being suitable. Miele cannot guarantee trouble-free operation if the appliance is operated in combination with appliances other than those quoted by Miele as being suitable.
- ▶ The base on which the drawer and the combination appliance are fitted must be fixed in place and must support the weight of both appliances.
- ▶ When building in the combination appliance, it is essential to follow the instructions given in the operating and installation instructions supplied with the combination appliance.
- ▶ When installing the drawer, the following should be noted:
 - The contents of the dishes must be visible. This is to avoid scalding from hot food spilling over.
 - There must be enough space for the drawer to be pulled out fully.

Installation

Installation notes

The drawer can be used in combination with the following Miele built-in appliances:

- all ovens with an appliance front width of 595 mm
- all steam ovens with an appliance front width of 595 mm
- all coffee machines with an appliance front width of 595 mm
- all microwaves with an appliance front width of 595 mm
- the Dialog oven with an appliance front width of 595 mm

The combination appliance is placed on top of the drawer without the need for an interim shelf.

The drawer is available in 3 models, which differ in height. The building-in dimensions for the drawer must be added to the building-in dimensions for the combination appliance to establish the niche size required.

Installation dimensions ESW 7010, ESW 7110

All dimensions are given in mm.

Combination appliance for niches with a height of 450 mm

The furniture housing unit must not have a back panel fitted behind the building-in niche.

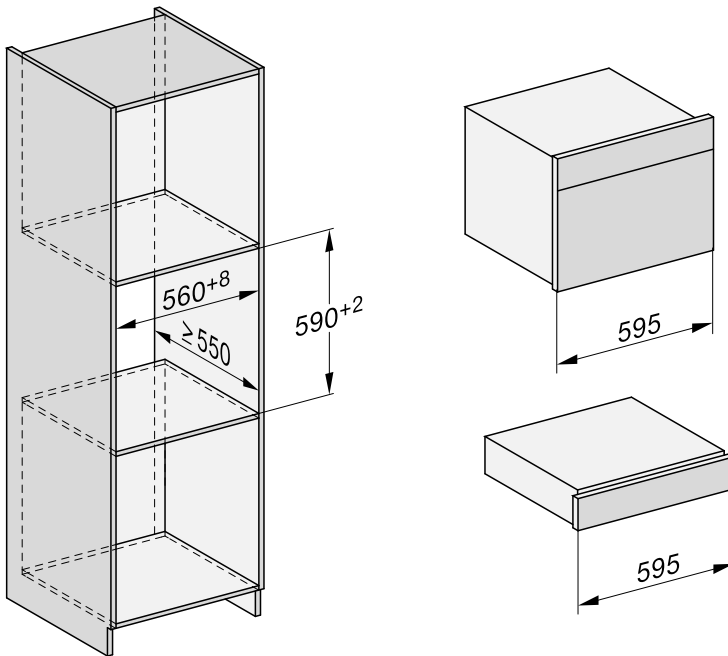

Installation

Combination appliance for niches with a height of 590 mm

The furniture housing unit must not have a back panel fitted behind the building-in niche.

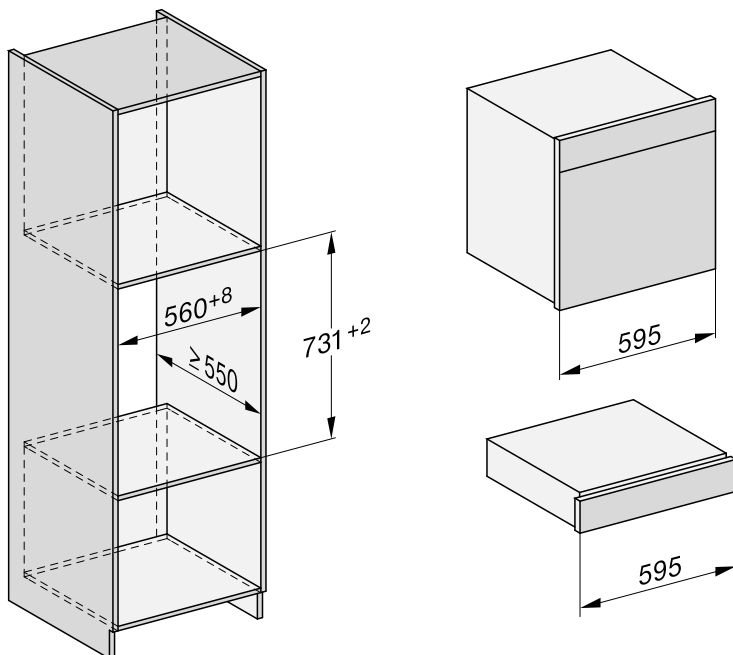

Side view

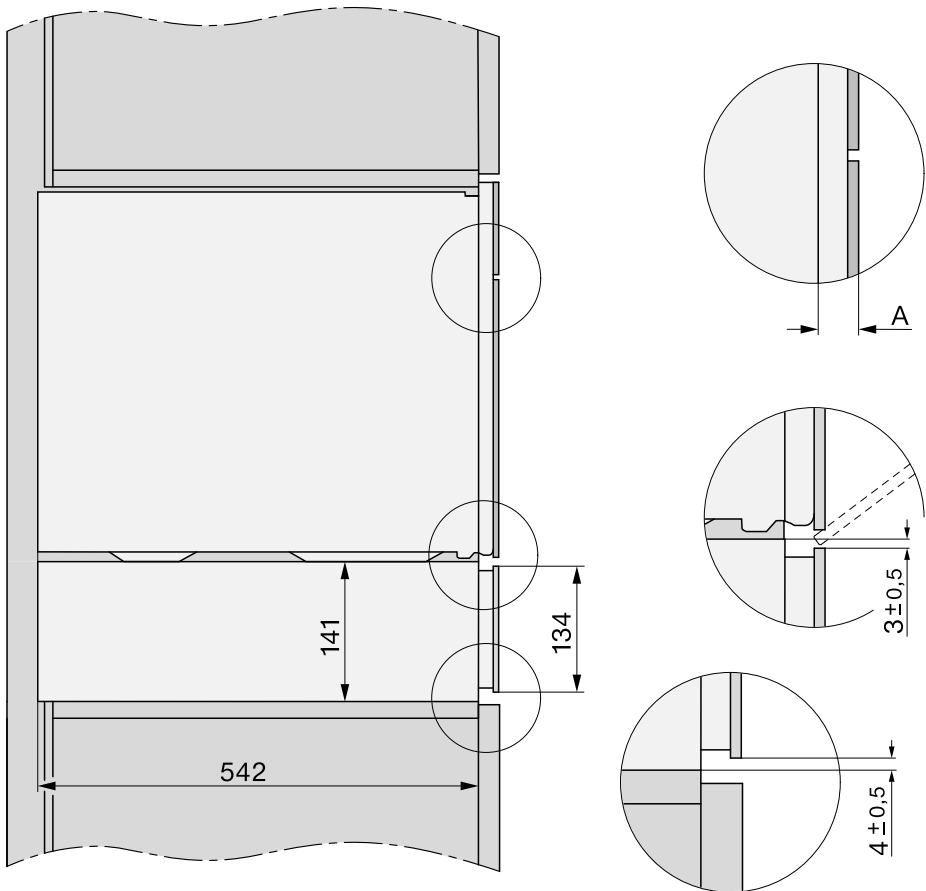

- A** ESW 70x0: 22 mm
ESW 71x0: 23.3 mm

Installation

Connections and ventilation

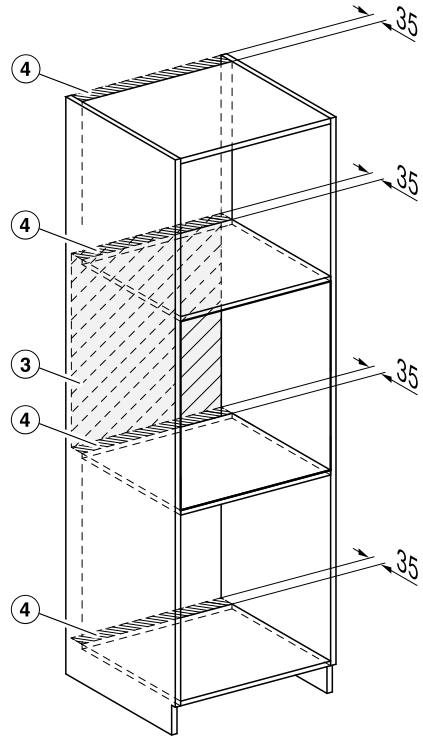
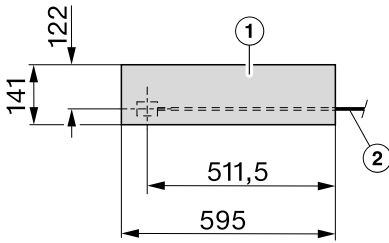

- ① View from the front
- ② Mains connection cable, L = 2000 mm
- ③ No connections permitted in this area
- ④ Ventilation cut-out, min. 1800 mm²

Installation dimensions ESW 7020, ESW 7120

All dimensions are given in mm.

Combination appliance for niches with a height of 450 mm

The furniture housing unit must not have a back panel fitted behind the building-in niche.

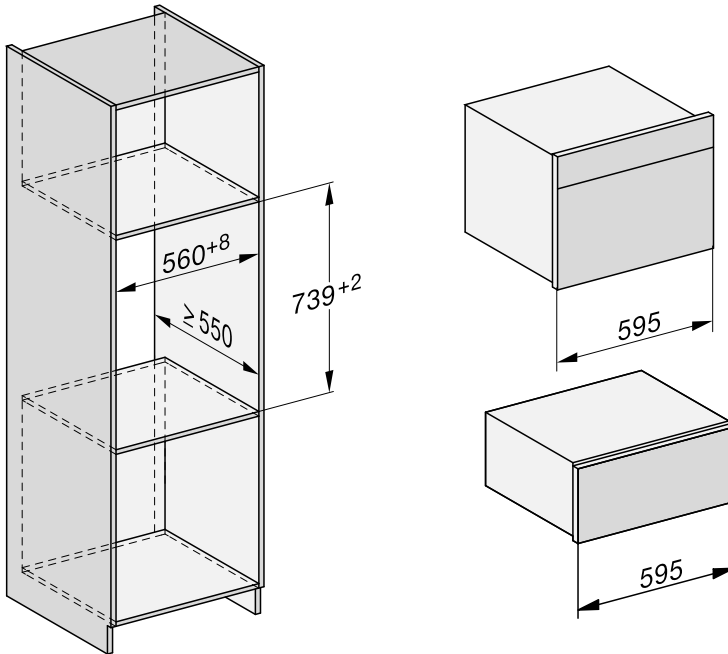

Installation

Combination appliance for niches with a height of 590 mm

The furniture housing unit must not have a back panel fitted behind the building-in niche.

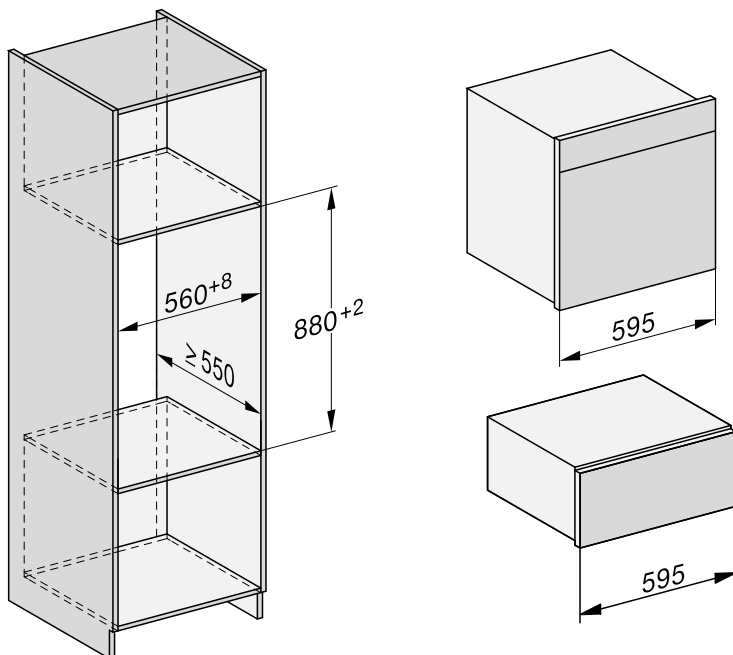

Side view

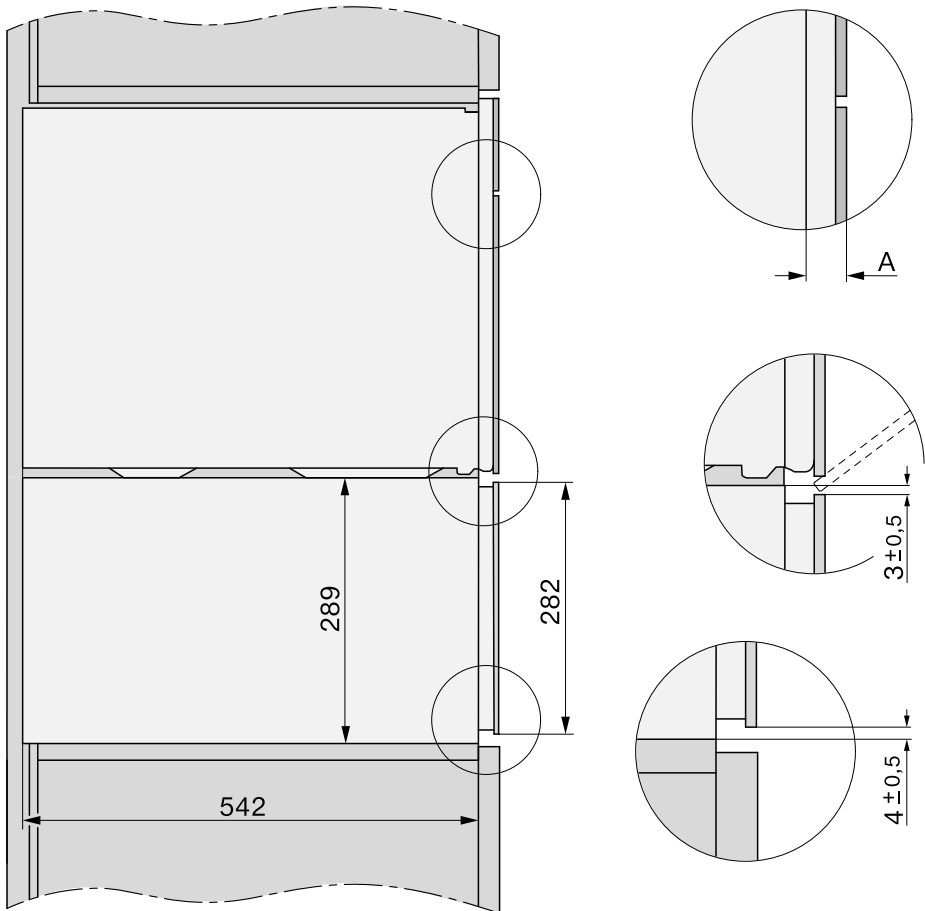

- A** ESW 70x0: 22 mm
ESW 71x0: 23.3 mm

Installation

Connections and ventilation

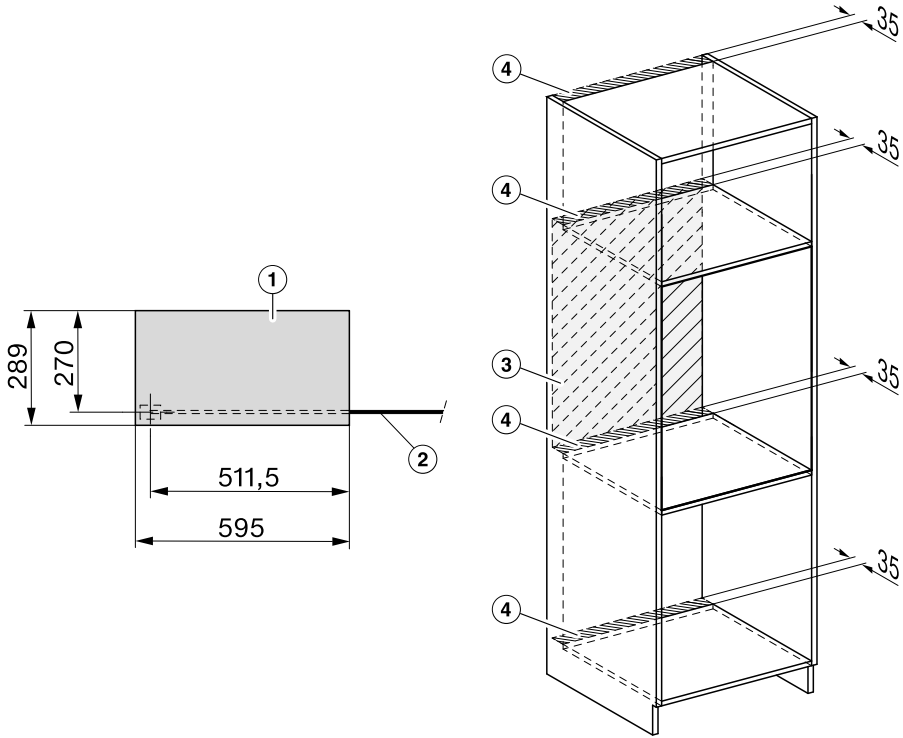

- ① View from the front
- ② Mains connection cable, L = 2000 mm
- ③ No connections permitted in this area
- ④ Ventilation cut-out, min. 1800 mm²

Installation dimensions ESW 7030

All dimensions are given in mm.

Combination appliance for niches with a height of 450 mm

The furniture housing unit must not have a back panel fitted behind the building-in niche.

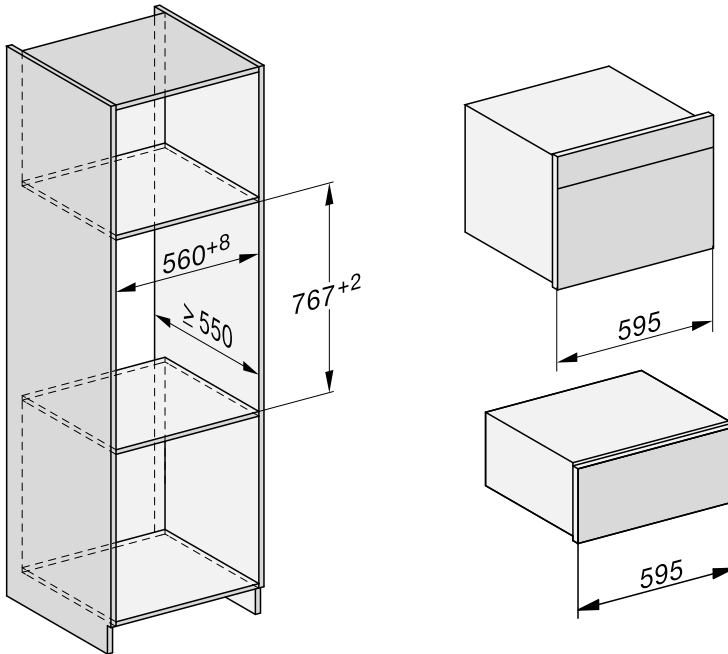

Installation

Combination appliance for niches with a height of 590 mm

The furniture housing unit must not have a back panel fitted behind the building-in niche.

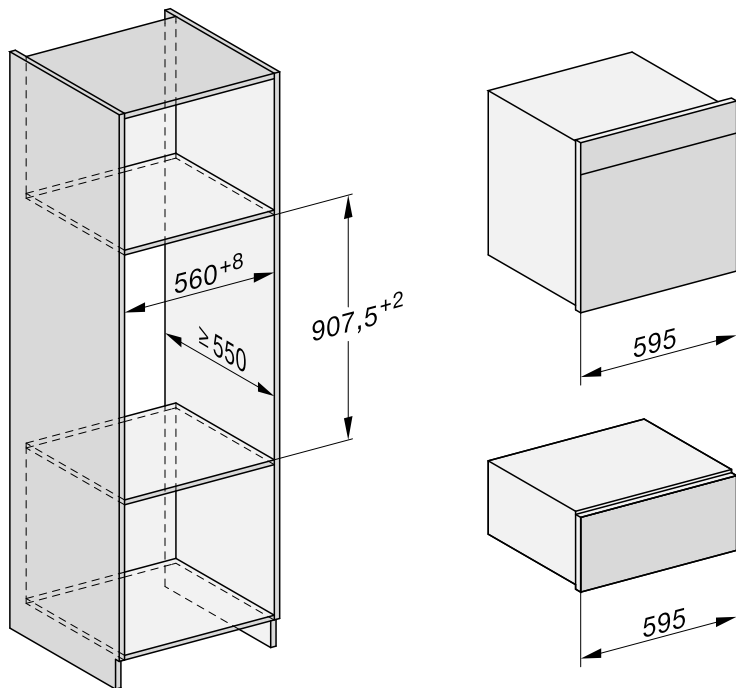

Side view

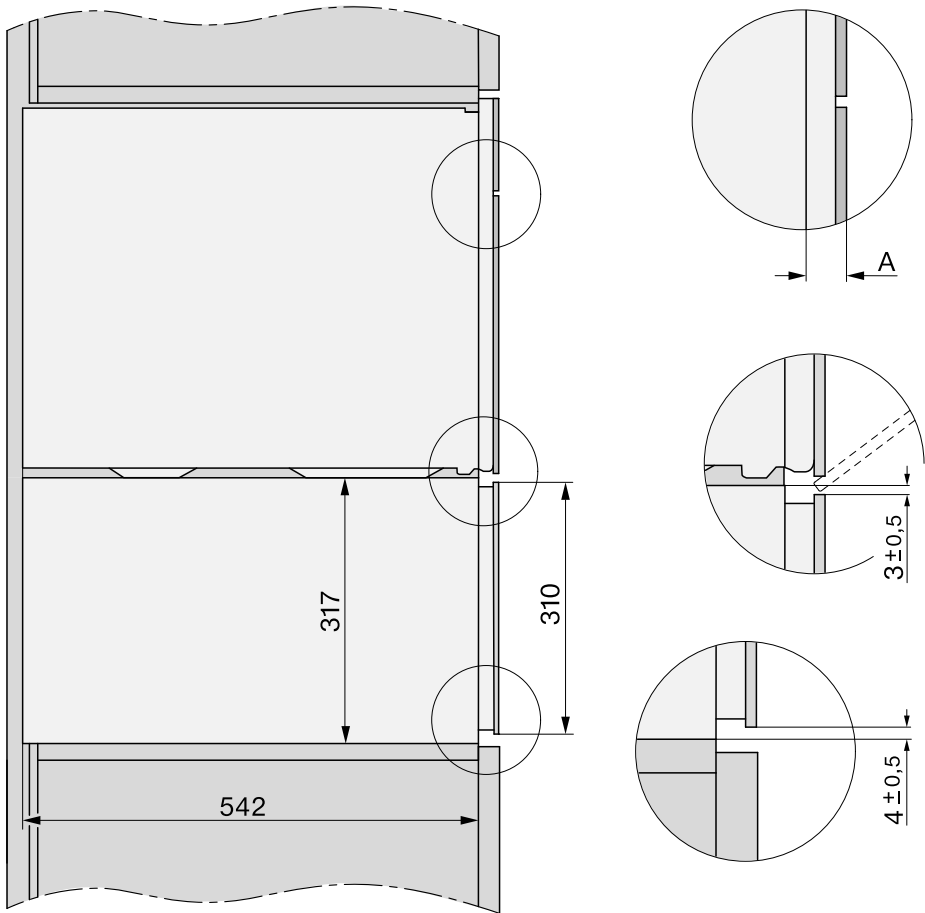

A ESW 7030: 22 mm

Installation

Connections and ventilation

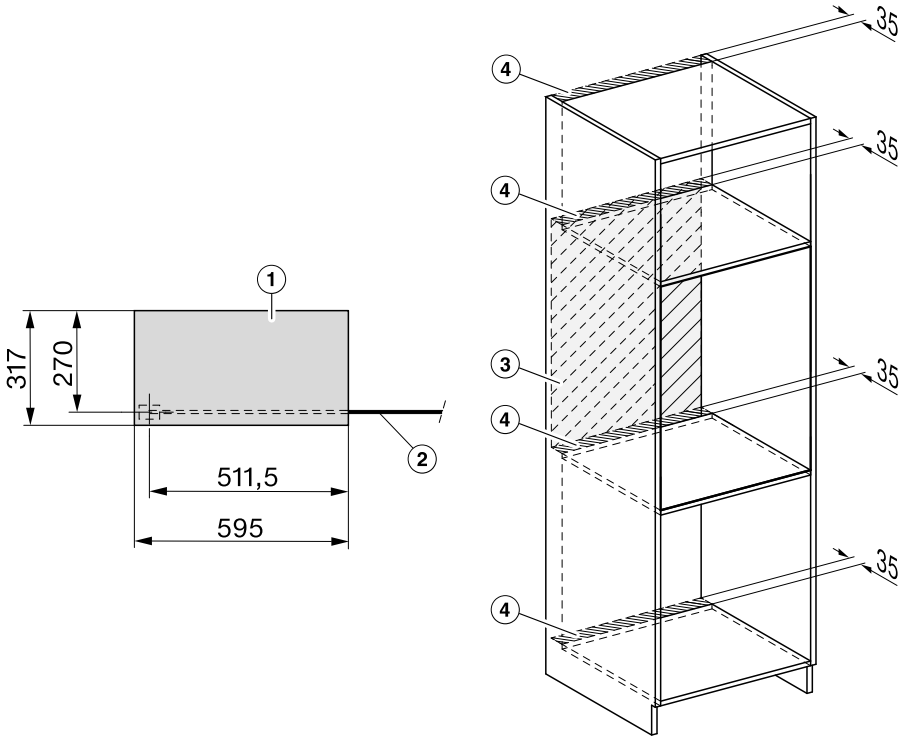

- ① View from the front
- ② Mains connection cable, L = 2000 mm
- ③ No connections permitted in this area
- ④ Ventilation cut-out, min. 1800 mm²

Installation

Check that the base on which the drawer will sit is clean and level (use a spirit level). This is important for the appliance to function correctly.

- Push the drawer into the housing unit until the drawer front is flush with the housing unit and make sure that it is correctly aligned in the unit.

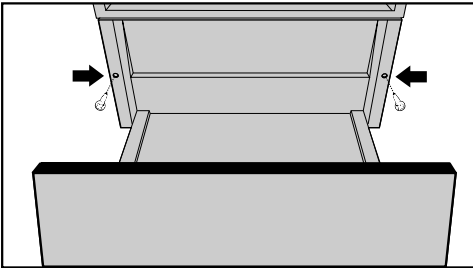

- Open the drawer, and use the 2 screws supplied to secure it to the side walls of the housing unit.
- When installing the combination appliance, protect the top edge of the front panel from abrasive marks.
- Install the combination appliance in accordance with the operating and installation instructions supplied with it.

Installation

Electrical connection

We recommend that you connect the drawer to the mains via a suitable switched electrical socket. This makes it easier to perform servicing work. The socket and on-off switch should be easily accessible after the drawer has been installed.

 Danger of injury due to unauthorised installation, maintenance and repairs.

Installation, repairs and other work by unqualified persons could be dangerous. Miele cannot be held liable for unauthorised work.

Miele cannot be held liable for damage or injury caused by the lack of or inadequacy of an on-site earthing system (e.g. electric shock).

If the plug is removed from the connection cable or if the cable is supplied without a plug, the drawer must be connected to the electrical supply by a suitably qualified electrician.

If the socket is no longer accessible, or if a hard-wired connection is planned, an additional means of disconnection must be provided for all poles. Suitable means of disconnection include switches with an all-pole contact gap of at least 3 mm. These include miniature circuit breakers, fuses and contactors. The required connection data is given on the data plate. Please ensure this information matches the mains supply.

After installation, ensure that all electrical components are shielded and cannot be accessed by users.

Total power rating

See data plate

Connection data

The connection data is quoted on the data plate. Please ensure these match the household mains supply.

Residual current device

For extra safety, it is advisable to protect the drawer with a suitable residual current device (RCD) with a trip range of 30 mA.

Disconnecting from the mains



Risk of electric shock.

There is a risk of electric shock if the appliance is connected to the mains supply during repair or service work. After disconnection, ensure the appliance cannot be switched back on by mistake.

To disconnect the appliance from the mains power supply, do one of the following depending on installation:

Safety fuses

- Completely remove fuses.

Automatic circuit breakers

- Press the (red) test button until the middle (black) button springs out.

Built-in circuit breakers

- Circuit breakers at least type B or C:
Switch the lever from 1 (on) to 0 (off).

Residual current device (RCD)

- Switch the main switch from 1 (on) to 0 (off) or press the test button.

Replacing the mains connection cable

When replacing the mains connection cable, please use cable type H 05 VV-F with a suitable cross-section. These cables are available from the manufacturer or from Miele Service.

EU Conformity declaration

Miele hereby declares that this drawer complies with Directive 2014/53/EU.

The complete text of the EU declaration of conformity is available from one of the following internet addresses:

- Products, Download from www.miele.ie
- For service, information, operating instructions etc: go to www.miele.ie/domestic/customer-information-385.htm and enter the name of the product or the serial number

Frequency band of the WiFi module	2.4000 GHz – 2.4835 GHz
-----------------------------------	-------------------------

Maximum transmitting power of the WiFi module	< 100 mW
---	----------

UK Conformity declaration

Miele hereby declares that this drawer complies with UK Radio Equipment Regulations 2017, as amended.

The complete text of the UK declaration of conformity is available from one of the following internet addresses:

- Products, Download from www.miele.co.uk
- For service, information, operating instructions etc: go to www.miele.co.uk and enter the name of the product or the serial number

Frequency band of the WiFi module	2.4000 GHz – 2.4835 GHz
-----------------------------------	-------------------------

Maximum transmitting power of the WiFi module	< 100 mW
---	----------

United Kingdom

Miele Co. Ltd., Fairacres, Marcham Road, Abingdon, Oxon, OX14 1TW

Tel: 0330 160 6600, Internet: www.miele.co.uk/service, E-mail: info@miele.co.uk

Australia

Miele Australia Pty. Ltd.
ACN 005 635 398
ABN 96 005 635 398
1 Gilbert Park Drive
Knoxfield, VIC 3180
Tel: 1300 464 353
Internet: www.miele.com.au

China Mainland

Miele Electrical Appliances Co., Ltd.
1-3 Floor, No. 82 Shi Men Yi Road
Jing' an District
200040 Shanghai, PRC
Tel: +86 21 6157 3500
Fax: +86 21 6157 3511
E-mail: info@miele.cn
Internet: www.miele.cn

Hong Kong, China

Miele (Hong Kong) Ltd.
41/F - 4101, Manhattan Place
23 Wang Tai Road
Kowloon Bay, Hong Kong
Tel: (852) 2610 1025
Fax: (852) 3579 1404
Email:
customerservices@miele.com.hk
Website: www.miele.hk

India

Miele India Pvt. Ltd.
1st Floor, Copia Corporate Suites,
Commercial Plot 9,
Mathura Road, Jasola,
New Delhi - 110025
E-mail: customercare@miele.in
Website: www.miele.in

Ireland

Miele Ireland Ltd.
2024 Bianconi Avenue
Citywest Business Campus
Dublin 24
Tel: (01) 461 07 10
Fax: (01) 461 07 97
E-Mail: info@miele.ie
Internet: www.miele.ie

Malaysia

Miele Sdn Bhd
Suite 12-2, Level 12
Menara Sapura Kencana
Petroleum
Solaris Dutamas No. 1
Jalan Dutamas 1
50480 Kuala Lumpur, Malaysia
Phone: +603-6209-0288
Fax: +603-6205-3768

New Zealand

Miele New Zealand Limited
IRD 98 463 631
8 College Hill
Freemans Bay, Auckland 1011
New Zealand
Tel: 0800 464 353
Internet: www.miele.co.nz

Singapore

Miele Pte. Ltd.
29 Media Circle
#11-04 ALICE@Mediapolis
Singapore 138565
sTel: +65 6735 1191
Fax: +65 6735 1161
E-Mail: info@miele.com.sg
Internet: www.miele.sg

South Africa

Miele (Pty) Ltd.
63 Peter Place
Bryanston 2194
P.O. Box 69434
Bryanston 2021
Tel: (011) 875 9000
Fax: (011) 875 9035
E-mail: info@miele.co.za
Internet: www.miele.co.za

Thailand

Miele Appliances Ltd.
BHIRAJ TOWER at EmQuartier
43rd Floor Unit 4301-4303
689 Sukhumvit Road
North Klongton Sub-District
Vadhana District
Bangkok 10110, Thailand

United Arab Emirates

Miele Appliances Ltd.
Showroom 1
Eiffel 1 Building
Sheikh Zayed Road, Umm Al Sheif
P.O. Box 114782 - Dubai
Tel. +971 4 3044 999
Fax. +971 4 3418 852
800-MIELE (64353)
E-Mail: info@miele.ae
Website: www.miele.ae

Manufacturer: Miele & Cie. KG, Carl-Miele-Straße 29, 33332 Gütersloh, Germany

ESW 7010, ESW 7020, ESW 7030, ESW 7110, ESW 7120

en-GB

M.-Nr. 11 226 210 / 08