

## **At A Glance**

### **What's In The Box**

**Step 1. Prepare the Door**

**Step 2. Install the Deadbolt**

**Step 3. Install the Exterior Assembly**

**Step 4. Install the Interior Assembly**

**Step 5. Install the Strike Plate**

**Step 6. Set up the System**

## At A Glance

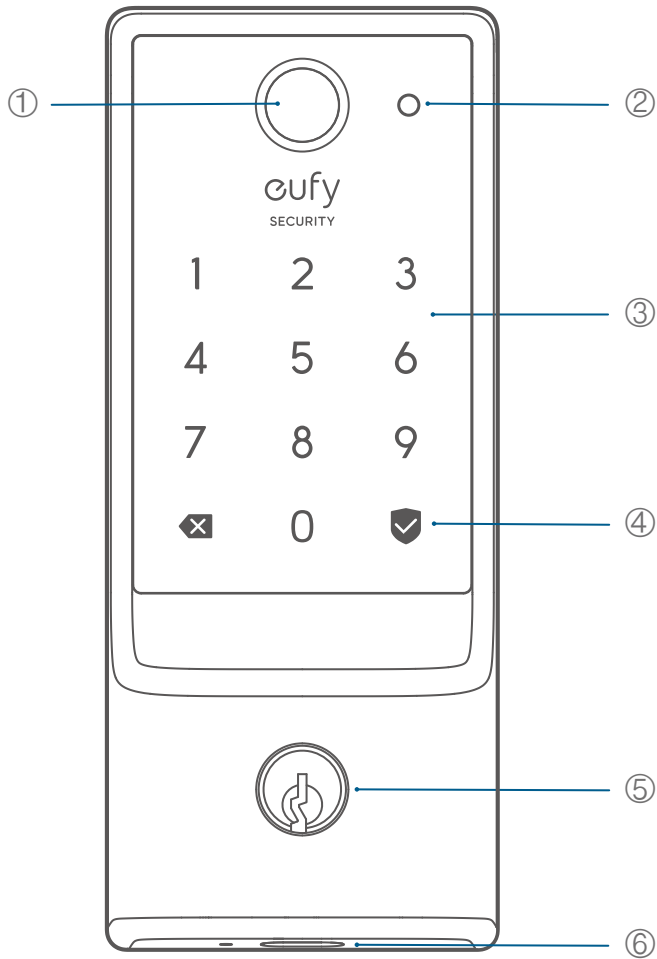

1. Fingerprint Button
2. Battery Indicator
3. Keypad
4. Status Light and Lock / Unlock Button  
Blue: Door unlocked  
Orange: Door locked  
Red: Abnormal state
5. Keyway: Can be copied, can't be rekeyed.
6. USB-C Port: Charges the lock in emergency situations.

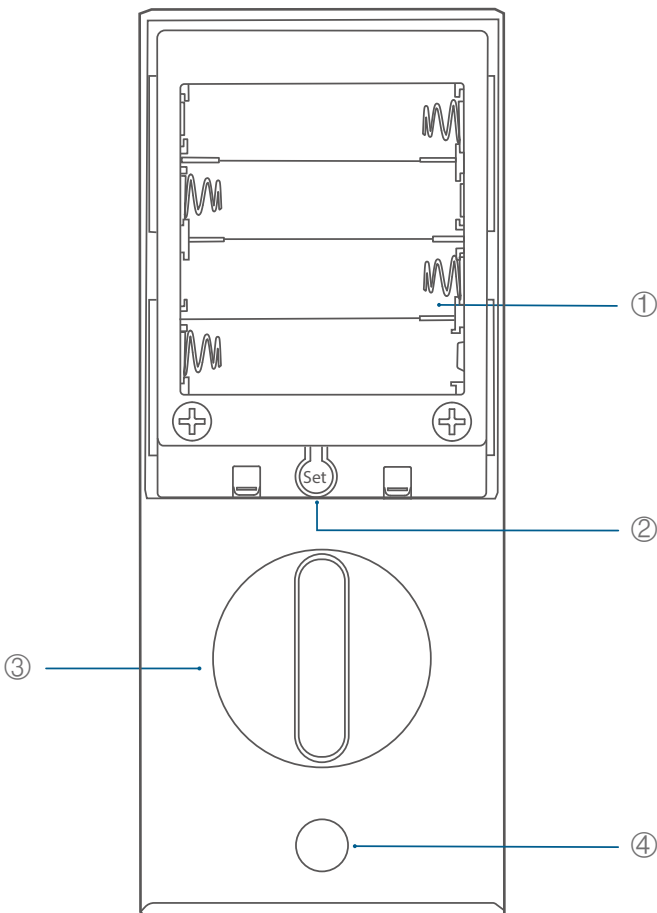

1. Battery Compartment
2. Setup Button
3. Thumbturn
4. Screw Hole

# What's In The Box

## (Step 2) Deadbolt Installation Set

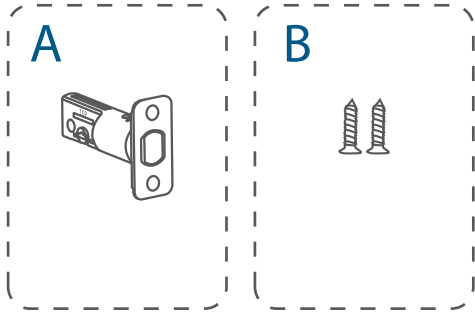

Deadbolt

Deadbolt Screws × 2

## (Step 3) Exterior Assembly

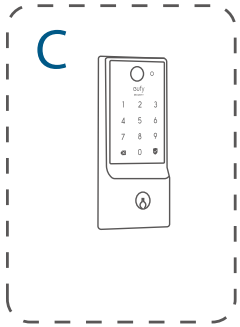

Exterior Assembly

## (Step 4) Interior Assembly Installation Set

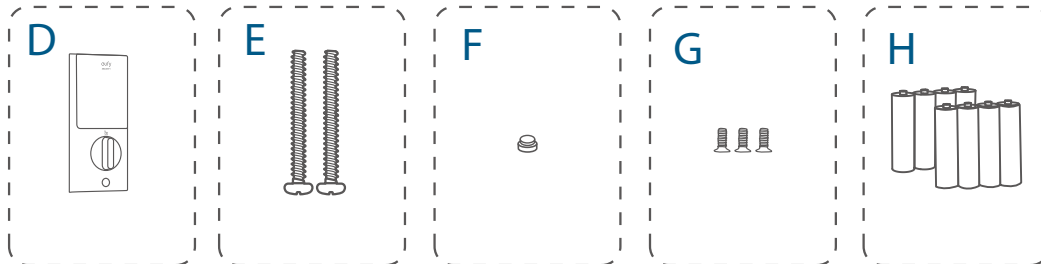

Interior Assembly

Screws

Silicone Plugs

Interior Assembly Screws

Batteries

## (Step 5) Strike Plate Installation Set



Strike Plate

Strike Screws

Keys

## Step 1. Prepare the Door

1. Remove the existing lock and check your door.
2. Check if your door has holes like the one below. Standard US doors are already compatible.

If not, follow the template to drill holes on your door.

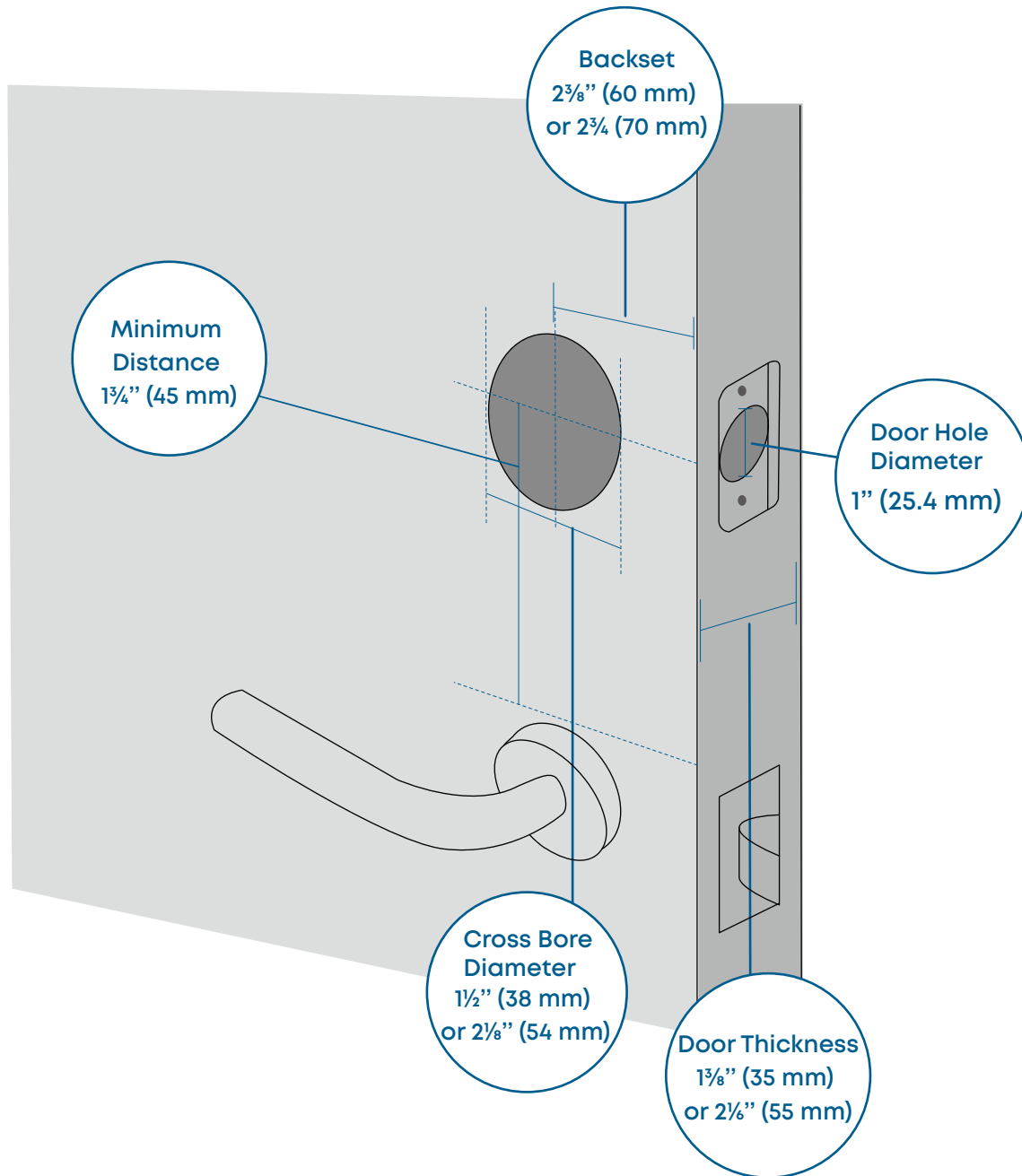

## Step 2. Install the Deadbolt

### 1. Adjust the Deadbolt

Measure the distance between center of the door hole to the edge of the door.

If the backset is  $2\frac{3}{8}$  in (60 mm), insert the deadbolt directly.

If the backset is  $2\frac{3}{4}$  in (70 mm), rotate the faceplate of the deadbolt  $180^\circ$  to adjust the deadbolt to 70 mm.

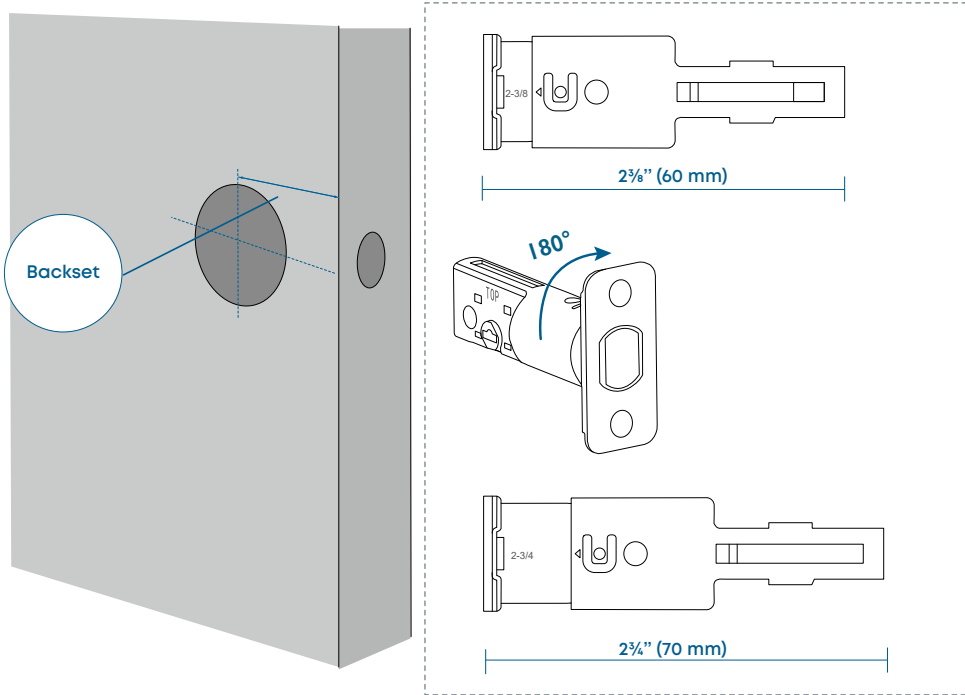

### 2. Check the Latch Recess

If your latch recess is **round**, contact eufy Support to get a round drive-in faceplate, and replace the existing one.

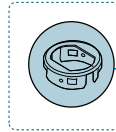
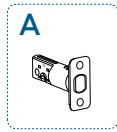
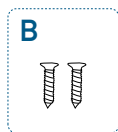
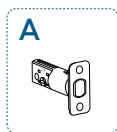
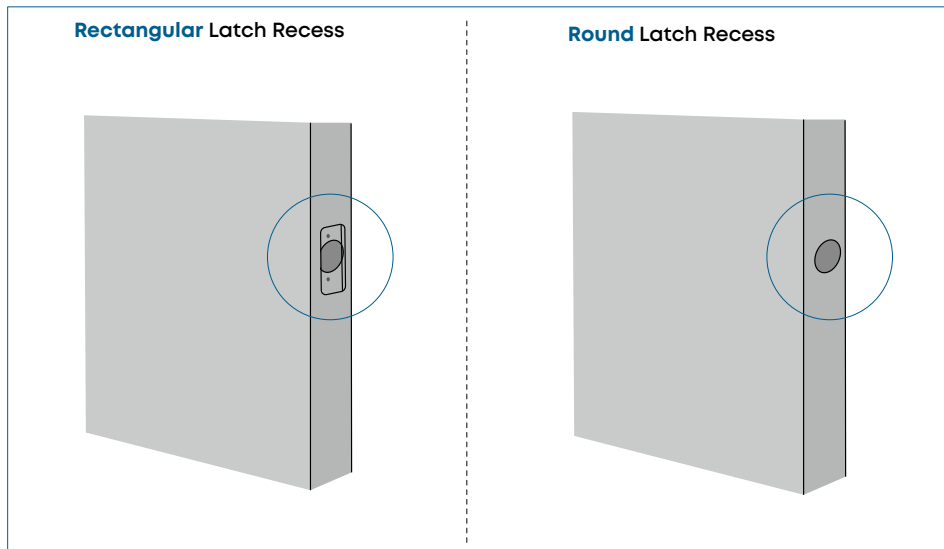

 Call eufy Support

### 3. Install the Deadbolt

- » If your latch recess is **rectangular**, insert and screw the provided deadbolt directly. Ensure the word "**TOP**" on the deadbolt faces up and the T-shaped hub is centered.

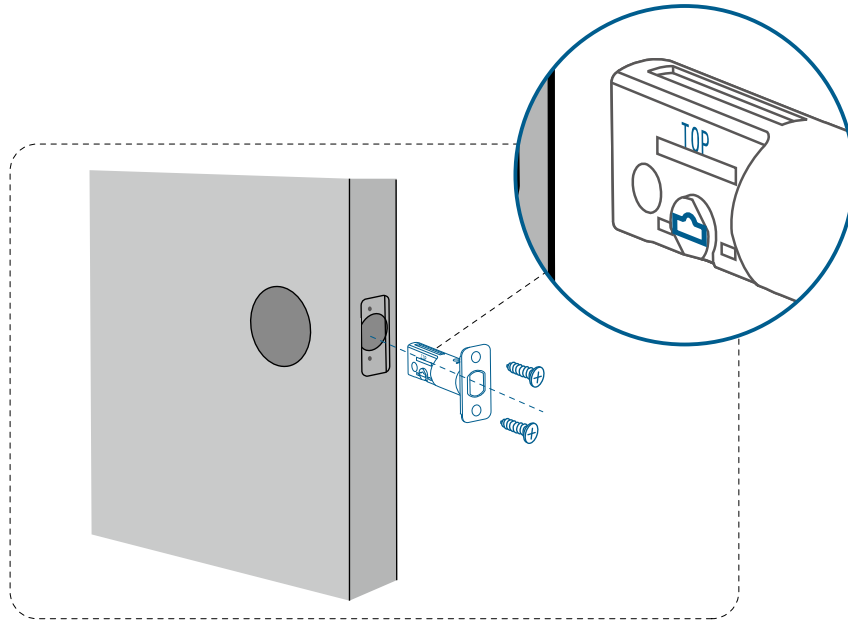

- » If your latch recess is **round**, swap the faceplate first:
  - 1) Take apart the current faceplate with a flathead screwdriver.
  - 2) Take off the other part of the faceplate.
  - 3) Slide the round drive-in faceplate onto the deadbolt.And then install the deadbolt into the door frame.

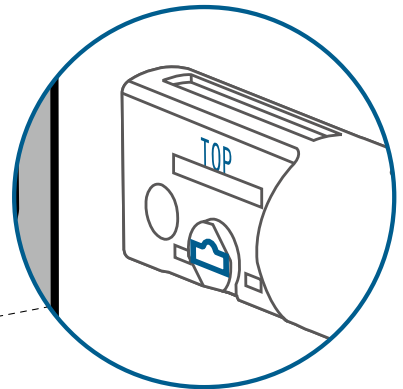
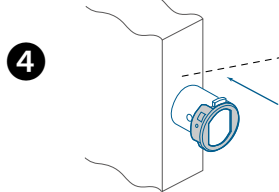
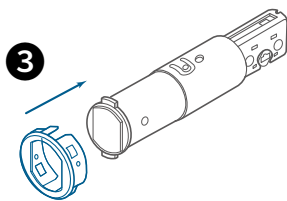
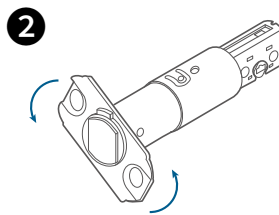
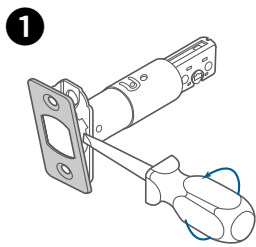

## Step 3. Install the Exterior Assembly

### 1. Measure Cross Bore Diameter

- If **2 1/8 in (54 mm)**, install the exterior assembly.
- If **1 1/2 in (38 mm)**, remove the spacer first, and install the exterior assembly.

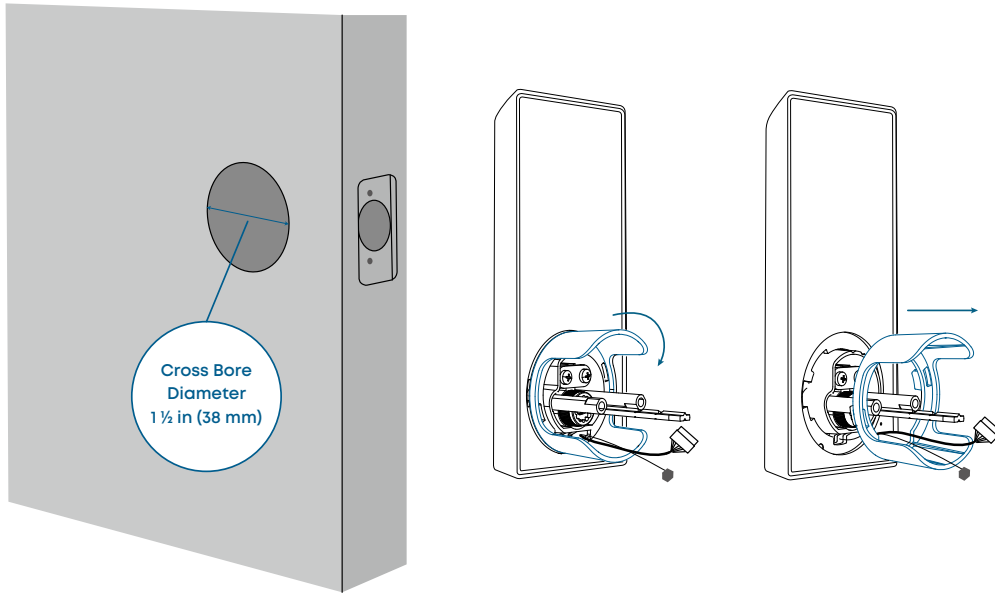

### 2. Attach Exterior Assembly to the Door

1. Feed the T-shaped tailpiece of the exterior assembly through the T-shaped tailpiece slot on the deadbolt.
2. Make sure the cables go underneath the deadbolt.

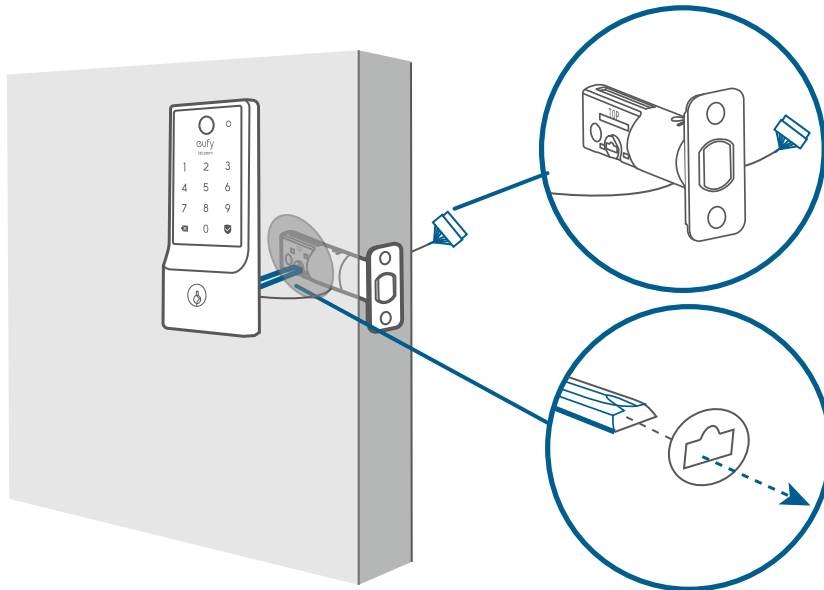

## Step 4. Install the Interior Assembly

1. Detach the back cover from the interior assembly.

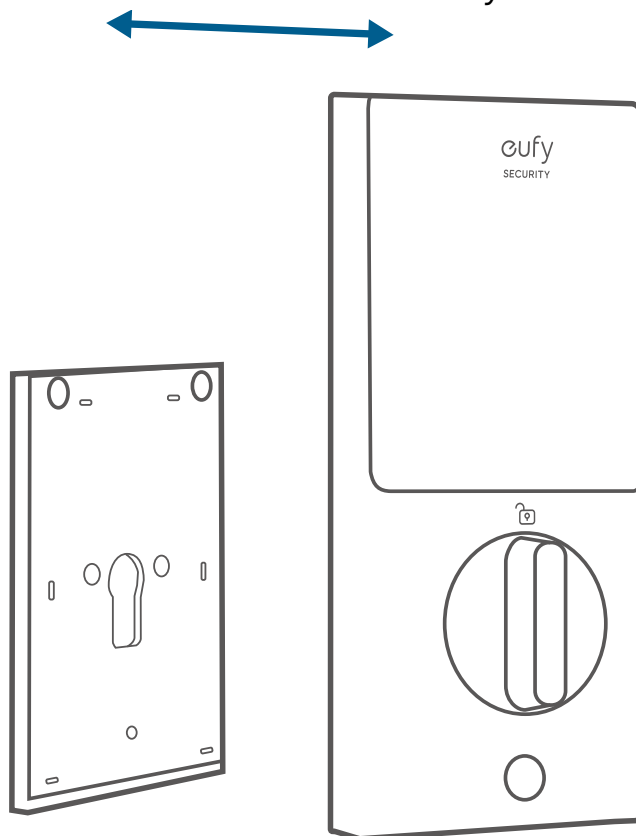

2. Run the wires through the back cover.

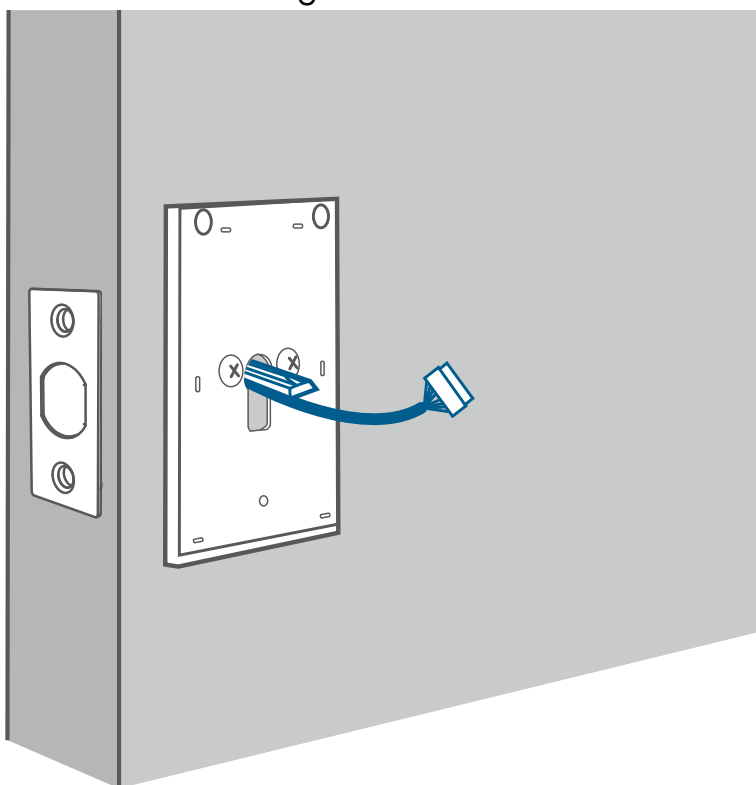

3. Secure the back cover with screws.

Tightly fasten the screws in place. Set the screws with your hands, then use a screwdriver to secure them.

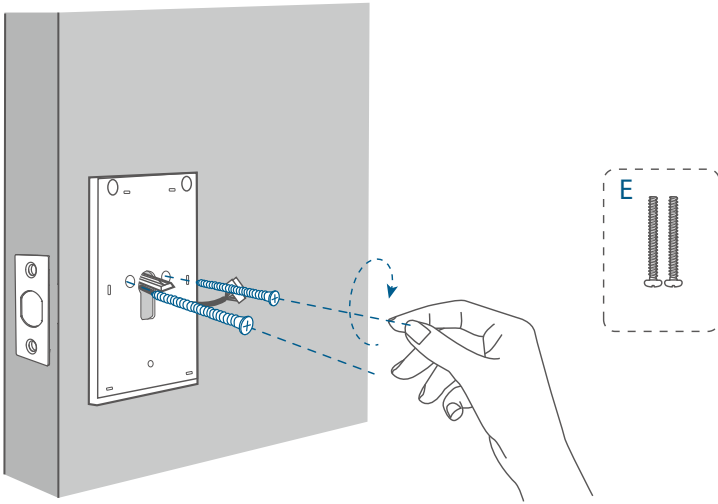

4. Wire to the interior assembly.

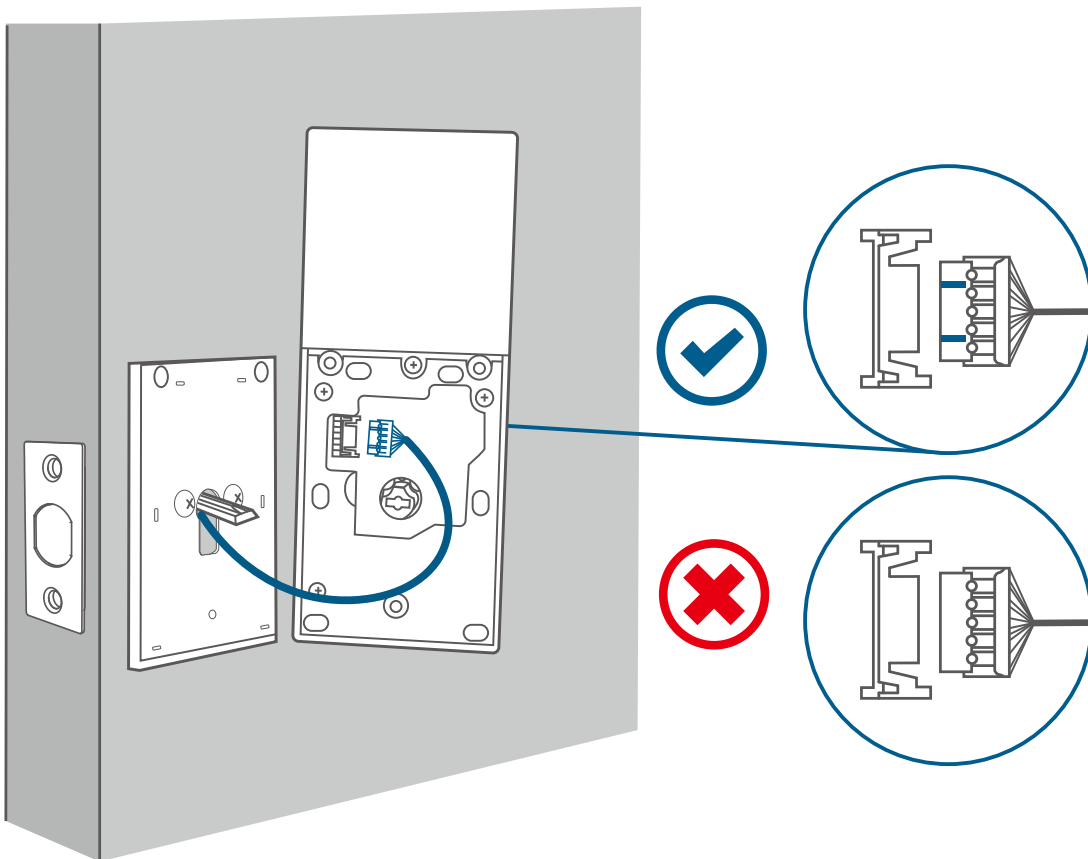

5. Mount the interior assembly. Make sure both wires are tucked into the cabin on the back of the interior assembly.

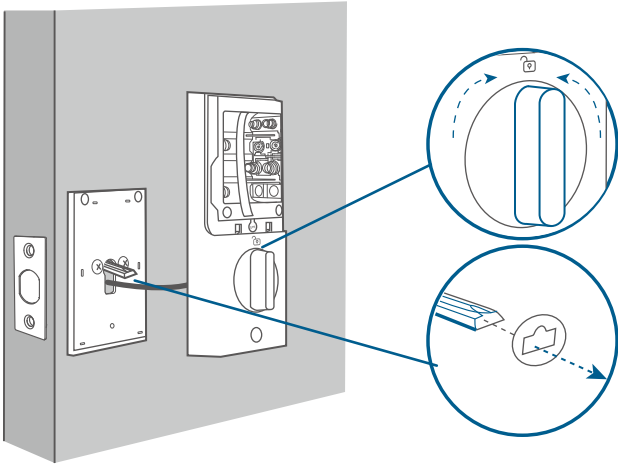

Make sure the deadbolt is retracted and the thumb turn knob is on the 'unlock' position, check if the deadbolt moves properly by turning the thumbturn.

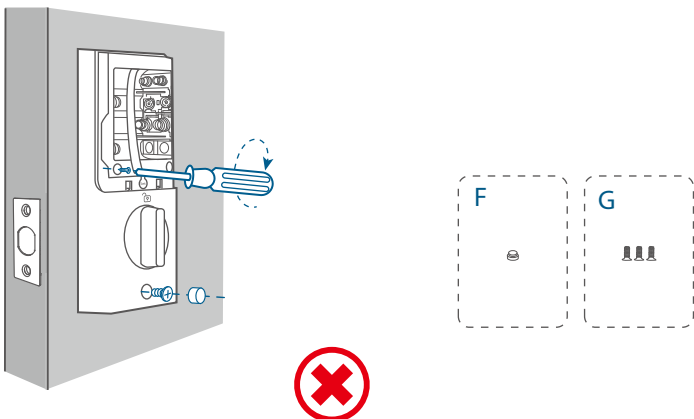
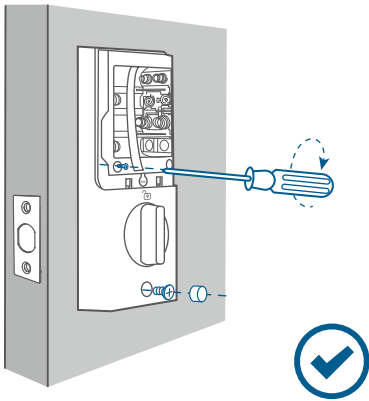
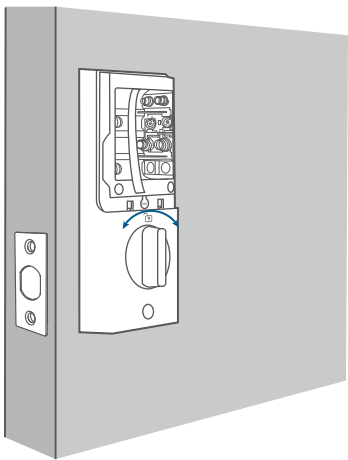

\*Use a long screwdriver to fasten the interior assembly screws.

6. Install the 8 AA batteries provided with the correct polarity. Don't put on the cover until the system setup is done in the app.

\*For your convenience, please first install the bottom layer of 4 AA batteries.

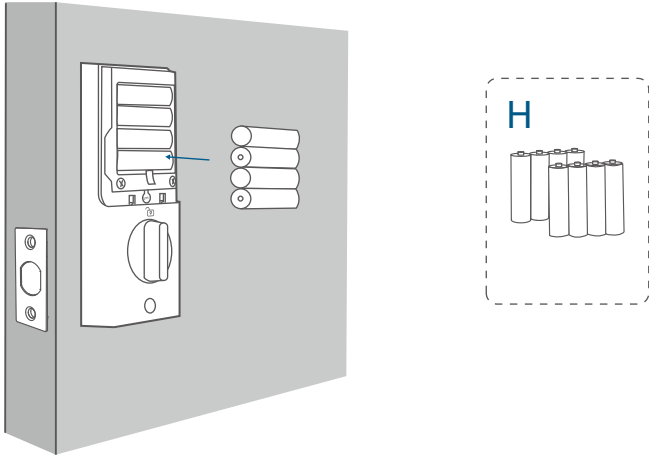

Friendly Reminder: When removing the batteries, first remove the upper layer, then gently pull the ribbon to lift the remaining batteries out of the compartment.

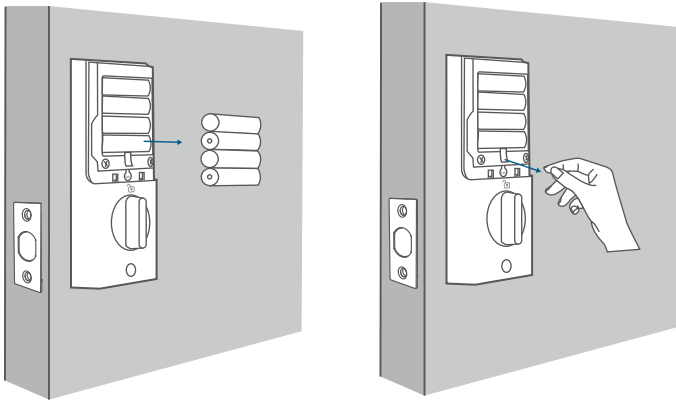

## Step 5. Install the Strike Plate

Make sure the depth of the latch hole on door frame is deep enough (1" / 25.4 mm), otherwise the calibration might fail during the setup.

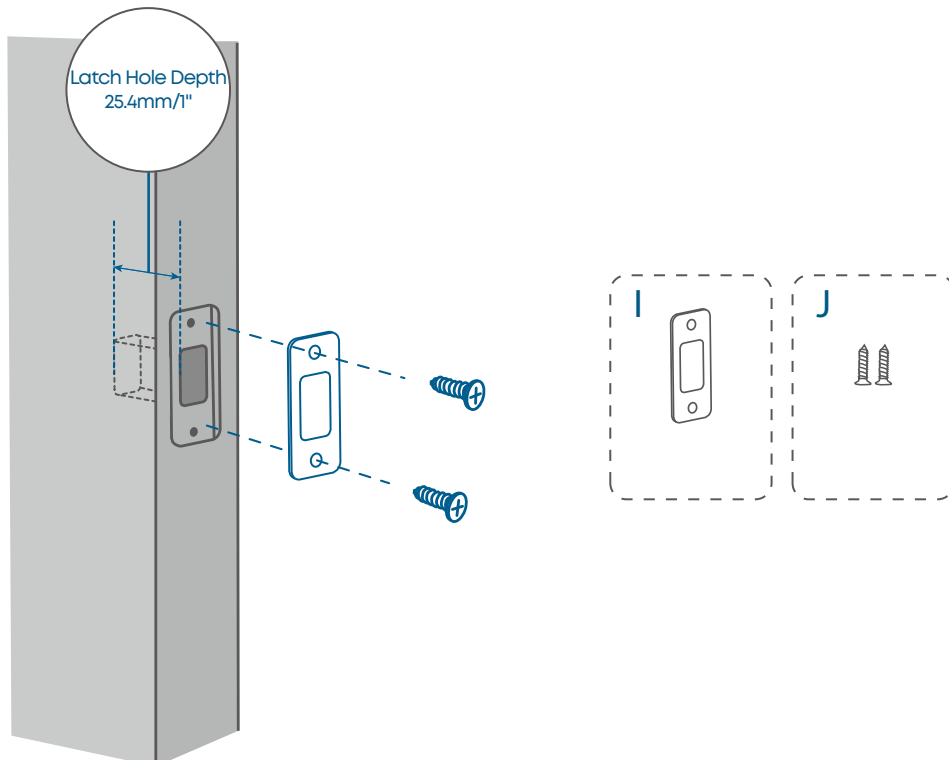

## Step 6. Set up the System

1. Download and install the eufy Security app, then sign up for an account.



2. Follow the in-app instructions to add the C220 Smart Lock to your device list.  
Please visit <https://support.eufylife.com/s/> or scan the QR code for more information.

