

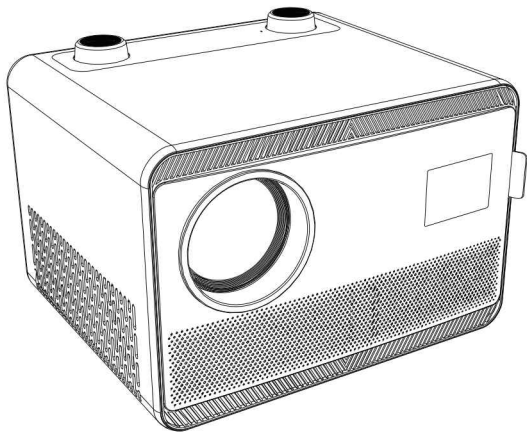

User Manual

Where Imagination Meets Reality



Model: C58

Please read this manual carefully before using the projector.

Important Safety Considerations

Attentions:

Thank you for purchasing this series of video projectors.

Please read through this User's manual for proper use of this product.



Friendly Reminder:

- 1 Do not look directly into the lens while the projector is running, as strong light may damage your eyes.
- 2 Do not block the air outlet to prevent the projector from cooling down because internal electronics are damaged.
- 3 Keep the projector and accessories out of the reach of children.
- 4 Please make sure that the working environment of the projector is dry and ventilated.
- 5 To prevent electric shock, please keep the projector out of the rain and away from moisture, it is recommended to switch off the projector after it has run for 6 hours non-stop.
- 6 Do not press hard on the projector, as it may damage the product.
- 7 Do not throw, hit, or shake the projector to avoid damaging the circuit board.
- 8 Any questions after receiving the projector, please contact us, we will quickly and correctly solve your problem within 24 hours and give you a satisfactory answer.

Any questions about this item, please.

-  1-888-986-2646(US)
-  US:service@happrunlife.com
-  EU:service.eu@happrunlife.com
-  UK:service.uk@happrunlife.com

Function Overview

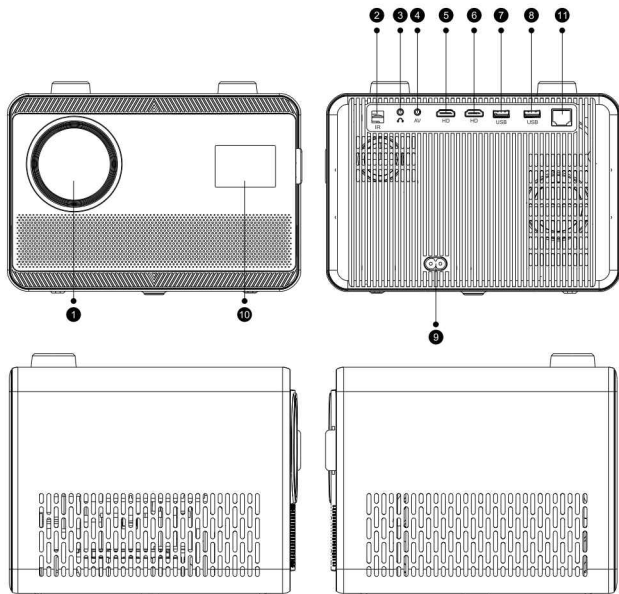

- ① Focus Lens
- ② IR
- ③ 3.5 mm Port for Audio Output
- ④ AV Port
- ⑤ HDMI 1
- ⑥ HDMI 2
- ⑦ USB 1
- ⑧ USB 2
- ⑨ Power
- ⑩ Camera & IR
- ⑪ LAN

Function Overview

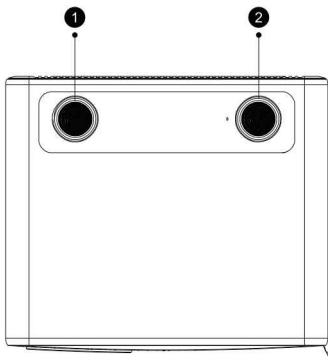

- 1** Focusing knob/BT shortcut key
(The left and right rotation buttons adjust the focus, and pressing the button quickly enters Bluetooth speaker mode.)
- 2** Volume knob / Power key
(The left and right rotation adjust the volume, and pressing the button turns the device on/off.)

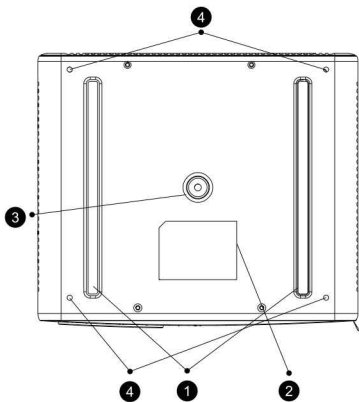

- 1** Rubber Foot Mats
- 2** Bottom Label
- 3** Ceiling Mounting Holes for the projector, M6.
- 4** Ceiling Mounting Holes for the projector, M4.

Tip: The projector ceiling mount bracket is not included. Additionally, when purchasing a projector mount, please ensure that the screw size and number of holes are compatible with the projector. We recommend purchasing a projector mount with four holes.

Remote Control Instructions

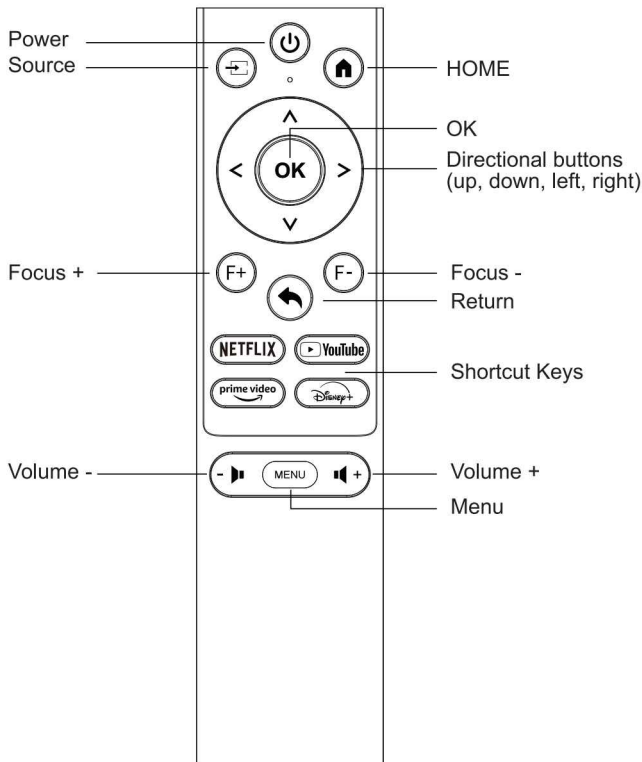

Note: Please install 2 AAA batteries (not included) into the remote control before use.

Operating Instructions

Power On/Off

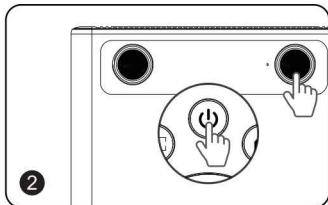
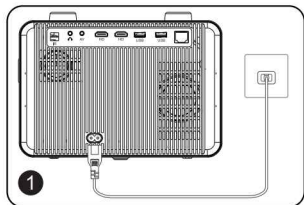

Connect the power adapter to an outlet.

Power on: When the power cord is properly connected, you can press the power button on the device or remote control to turn it on.

Standby mode: Press the power button to enter standby mode in use.

Power off: Press the power button for 3 seconds to shut down.

Launcher introduction

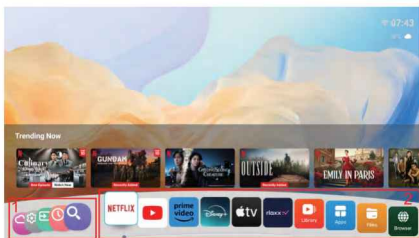

1. Quick Access

- ①. Weather: By default, the climate and temperature of the current city on the 7th this week are displayed. Change City can switch city display
- ②. Setting: Used for various functional debugging settings.
- ③. Source: Data source, used to connect with the data source.
- ④. Recently viewed: Record what users watch and use the App.
- ⑤. Search: global search function.

Operating Instructions

Home-settings



Picture: Image settings

Sound: Sound settings

Network: Connect Wi-Fi and settings.

Bluetooth: Connet the other BT device.

Operating Instructions

Network (Wi-Fi)



Scan QR Code

Go to the network settings, click "Connect to Network," select the corresponding Wi-Fi, and connect to the network.

Operating Instructions

Bluetooth

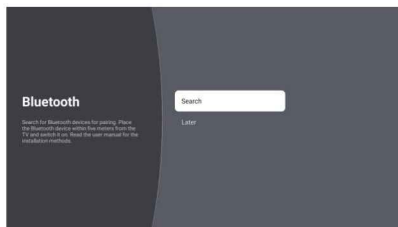
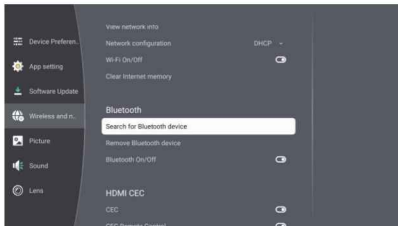
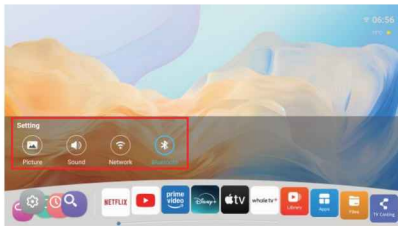

Scan QR Code

Go to the Bluetooth settings, click "Search for Bluetooth device," search for Bluetooth devices, and connect to the device.

Operating Instructions

Lens

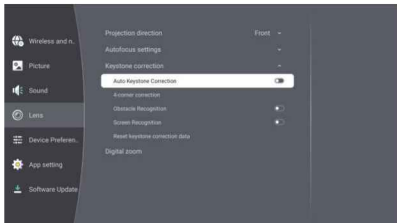

Scan QR Code

Projection Direction:
Adjust different projection methods.

Autofocus Settings:
The projector will enter auto focus mode. The projector can automatically adjust for a clear image. After completing auto focus but the image is still unclear, you can press "F+/F_" for electronic focus to make the image clear.

Keystone Correction:

① **Auto Keystone Correction:** When the position of the device changes, it will adjust the image to ensure the projection is squared. (Note: The Auto Keystone function is best experienced when the projector is tilted at an angle of 15 degrees.)

② **Obstacle Recognition:** When the device encounters an obstacle, the projection automatically avoids it.

(Note: The best experience for the automatic obstacle avoidance function is achieved when the projector's tilt angle is within 15 degrees, and the obstacle does not block the focus point of the screen.)

③ **Screen Recognition:** When the device projects onto a screen with black borders, the projection automatically adapts to fit accurately within the screen's interior.

Operating Instructions

Whale OS Cast

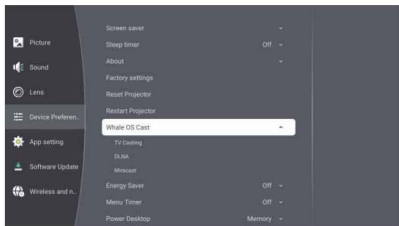

Scan QR Code

Click on " Settings" on the home page, select" Set Preferences", and then open" Whale OSCast".

iPhone Screen Mirroring



1. Make sure your phone and the projector are on the same network.
2. Click "click here to open TV Casting".
3. On your phone, open the screen mirroring button and select the projector to start mirroring.

NOTES:

iPad users need to scan the QR code above to download and install the app. iPhone users do not need to download it.

And then Open the app on your iPad, select the device, and start screen mirroring.

Operating Instructions

Android Screen Mirroring

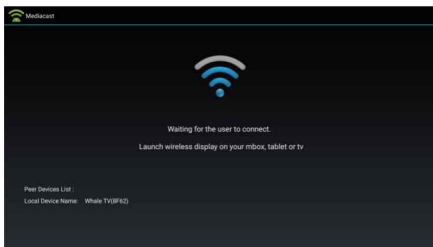
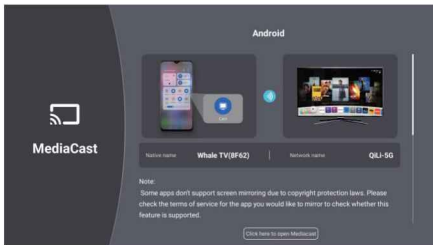

1. Make sure your phone and the projector are on the same network.
2. Click "click here to open MediaCast", Enter the MediaCast waiting page.
3. On your phone, open the screen mirroring button and select the projector to start mirroring.

PS: Some apps may not allow screen mirroring due to copyright issues. This is normal and unrelated to the projector.

Operating Instructions

Home-Source

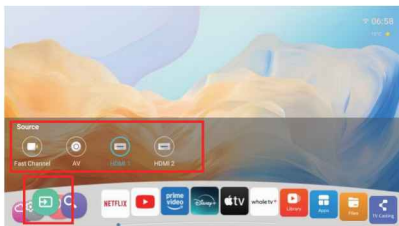

Scan QR Code

After plugging in the USB drive, wait for 3-5 seconds, then open "Files" from the app list to browse videos, music, and pictures on the USB drive.

USB Connet



Scan QR Code

Connect the projector to external devices using an HD cable, select the corresponding HD port, and immerse yourself in the big-screen experience.

Operating Instructions

Home-Recently

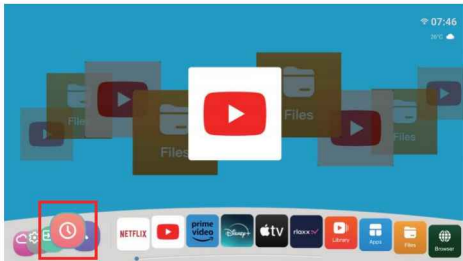

Recently displays information such as applications and content recently used by the user.

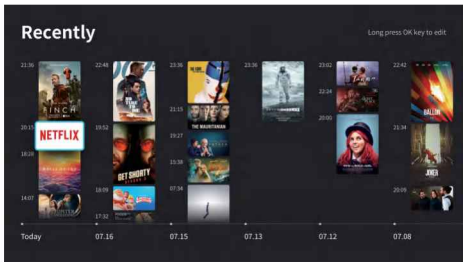

The last 7 days of data are recorded on a daily basis. If there is no usage data on that day, it will be collapsed and not displayed.

Operating Instructions

Home-Search



The secondary menu displays recommended Movie content (click to enter Library).

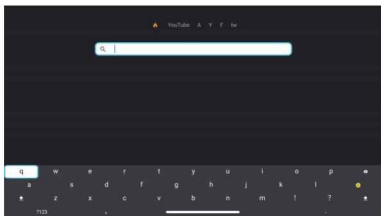

Search & Search Results.

Operating Instructions

Home-Apps

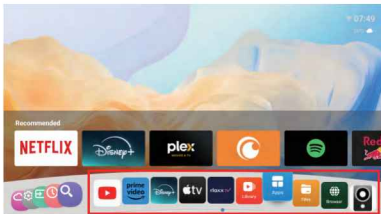

Displays the commonly used apps you have installed. If you want to install more apps, you can open "Apps" from the app list entry and download the apps you want.

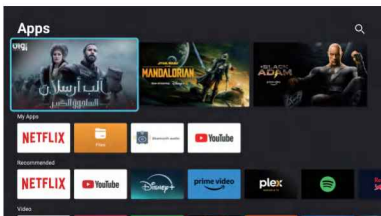

Display popular applications.

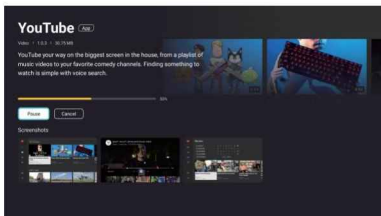

Application download.

Operating Instructions

Player

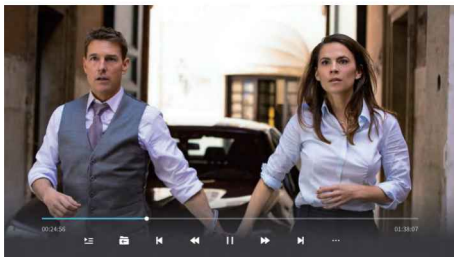

Functions are introduced from left to right:

- | | |
|--------------|----------------|
| 1. Playlist | 5. Pause/ play |
| 2. File back | 6. Forward |
| 3. Previous | 7. Next |
| 4. Rewind | 8. More |

Play-Mode

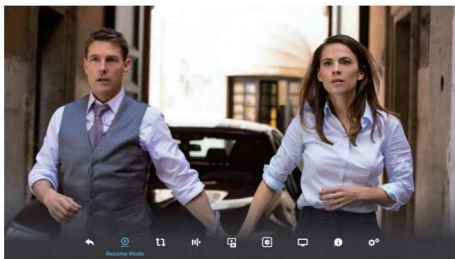

Packing List

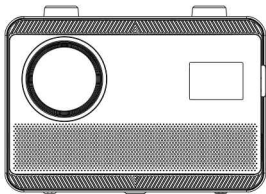

Projector



User Manual



HD Cable



Remote

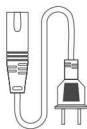

Power Cable

Specification

Model	C58
Display Technology	LCD
Light Source	LED
Resolution	1920*1080P
Installation Type	Front / Rear / Ceiling
Focus	Auto, Electric, Manual
Keystone	Auto, Electric
Speaker	10W*2
Power Input	AC 100~240V, 50/60Hz
Unit Dimension	7.6*7.6*3.2 inch
Unit Net Weight	72 lb
Photo Format Supported	JPEG/PNG/BMP
Audio Format Supported	MP2 / MP3 / WAV / AAC / AAC2 / AMR / Vorbis / FLAC / OGG / WMA / WMA2
Video Format Supported	H264 / MPEG2 / MPEG4 / VC1 / V-VP8 / WMVP9 / MJPEG / AVC / FLV1 / M-JPEG / Xvid
Mounting Screws	M6 or M4 (not included)
Input Ports	AV*1, HDMI*2, USB*2, LAN*1
Output Ports	3.5 mm Headphone
Operating System	Android
Working Temperature	0~35°C

TOP SERVICE:

Any questions about this item, please

 1-888-986-2646(US)

 US:service@happrunlife.com

 EU:service.eu@happrunlife.com

 UK:service.uk@happrunlife.com

