

# Swanson

## Installation Manual

Model: 50901 New Bronze  
50909 Matte Silver  
50908 Fresh White  
Fan weight  $\pm 2$  lbs: 16.1 lbs (7.3 kg)

*Hunter*

© 2019 Hunter Fan Company  
7130 Goodlett Farms Pkwy, Suite 400  
Memphis TN 38016 PG3847 r120519

The ceiling fan you purchased will provide comfort and performance in your home or office for many years. This instruction manual contains complete instructions for installing and operating your fan. We are proud of our work and appreciate the opportunity to supply you with the best ceiling fan available anywhere in the world.

## We are here to help!

This Instruction Manual is designed to make installation as simple as possible. While working through this Instruction Manual, keep your smartphone or tablet nearby. We have added video links to help you through the more technical sections. If you are unfamiliar or uncomfortable with wiring, contact a qualified electrician. We also provide telephone support at 1.888.830.1326 or visit us at [HunterFan.com](http://HunterFan.com).



**READ and SAVE These Instructions**

**WARNING**



This product conforms to UL Standard 507.

## Warning

w.1 - To reduce the risk of fire, electrical shock, or personal injury, mount fan directly from building structure and/or an outlet box marked acceptable for fan support of 70 lbs (31.8 kg) and use the mounting screws provided with the outlet box.

w.2 - To avoid possible electrical shock, before installing or servicing your fan, disconnect the power by turning off the circuit breakers to the outlet box and associated wall switch location. If you cannot lock the circuit breakers in the off position, securely fasten a prominent warning device, such as a tag, to the service panel.

w.3 - To reduce the risk of electric shock, this fan must be installed with an isolating wall control/switch.

w.4 - To reduce the risk of personal injury, do not bend the blade brackets when installing the blade brackets, balancing the blades, or cleaning the fan. Do not insert foreign objects in between rotating fan blades.

## Caution

c.1 - All wiring must be in accordance with national and local electrical codes ANSI/NFPA 70. If you are unfamiliar with wiring, use a qualified electrician.

c.2 - Use only Hunter replacement parts.

This equipment has been tested and found to comply with the limits for a Class B digital device, pursuant to part 15 of the FCC Rules. These limits are designed to provide reasonable protection against harmful interference in a residential installation. This equipment generates, uses and can radiate radio frequency energy and if not installed and used in accordance with the instructions may cause harmful interference to radio communications.

However, there is no guarantee that interference will not occur in a particular installation. If this equipment does cause harmful interference to radio or television reception, which can be determined by turning the equipment off and on, the user is encouraged to try to correct the interference by one or more of the following measures:

- Reorient or relocate the receiving antenna.
- Increase the separation between the equipment and receiver.
- Connect the equipment into an outlet on a circuit different from that to which the receiver is connected.
- Consult the dealer or an experienced radio/TV technician for help.

Caution: modifications not approved by the party responsible for compliance could void user's authority to operate the equipment.

This device complies with Part 15 of the FCC Rules. Operation is subject to the following two conditions: (1) This device may not cause harmful interference, and (2) this device must accept any interference received, including interference that may cause undesired operation.

## Limited Lifetime Warranty

Hunter Fan Company grants this limited warranty to the original purchaser of this Hunter ceiling fan. This document can be found at [www.HunterFan.com](http://www.HunterFan.com).

Thank you for choosing Hunter!

### How Can Warranty Service Be Obtained?

**Proof of purchase is required** when requesting warranty service. The original purchaser must present a sales receipt or other document that establishes proof of purchase. Hunter, at its sole discretion, may accept a gift receipt. To obtain service, contact Hunter Fan Company online or by phone.

[www.HunterFan.com/Support/Contact-Us/](http://www.HunterFan.com/Support/Contact-Us/)  
1-888-830-1326

Please do not ship your fan or any fan parts to Hunter. Delivery will be refused.

### What Does This Warranty Cover?

#### Motor — Limited Lifetime Warranty

If any part of your ceiling fan motor fails during your ownership of the fan due to a defect in material or workmanship, as determined solely by Hunter, Hunter will provide you with a replacement fan free of charge.\* The foregoing limited warranty applies only to the motor itself and does not apply to electronic controls – such as remote control transmitters, remote control receivers, or capacitors – used in conjunction with the motor. Such electronic control items are included in the one-year limited warranty below.

#### Other — One-Year Limited Warranty

Except as otherwise indicated throughout this warranty, if any part of your Hunter ceiling fan fails at any time within one year of the date of purchase due to a defect in material or workmanship, as determined solely by Hunter, Hunter will provide a replacement part free of charge.\*

#### Light Kits — Warranty May Vary

Light kits are included in the one-year limited warranty. However, you may qualify for additional warranty coverage if your fan includes one of the following:

- **LED Light Kits — Three-Year Limited Warranty**  
If your LED light kit module (not including glass components) or LED bulb fails at any time within three years of the date of purchase due to a defect

in material or workmanship, as determined solely by Hunter, Hunter will provide a replacement part free of charge.\*

*\* If no replacement product/part can be provided for your fan, we will provide a comparable or superior replacement product/part at the sole discretion of Hunter.*

### What Does This Warranty NOT Cover?

**Labor Excluded.** This warranty does not cover any costs or fees associated with the labor (including electrician's fees) required to install, remove, or replace a fan or any fan parts. There is no warranty for light bulbs (except where otherwise noted); remote control batteries; fans purchased or installed outside the United States; fans owned by someone other than the original purchaser; fans for which proof of purchase has not been established; fans purchased from an unauthorized dealer; ordinary wear and tear; minor cosmetic blemishes; refurbished fans; and fans that are damaged due to any of the following: improper installation, misuse, abuse, improper care, failure to follow Hunter instructions, accidental damage caused by the fan owner or related parties, modifications to the fan, improper or incorrectly performed maintenance or repair, improper voltage supply or power surge, use of improper parts or accessories, failure to provide maintenance to the fan, or acts of God (e.g. flood).

ORIGINAL PURCHASER'S SOLE AND EXCLUSIVE REMEDY FOR A CLAIM OF ANY KIND WITH RESPECT TO THIS PRODUCT SHALL BE THE REMEDIES SET FORTH HEREIN. HUNTER FAN COMPANY IS NOT RESPONSIBLE FOR CONSEQUENTIAL OR INCIDENTAL DAMAGES, DUE TO PRODUCT FAILURE, WHETHER ARISING OUT OF BREACH OF WARRANTY, BREACH OF CONTRACT, OR OTHERWISE. Some States do not allow the exclusion or limitation of incidental or consequential damages, so the above limitation or exclusion may not apply to you. ANY IMPLIED WARRANTIES OF MERCHANTABILITY OR FITNESS FOR A PARTICULAR PURPOSE APPLICABLE TO THIS PRODUCT ARE LIMITED IN DURATION TO THE PERIOD OF COVERAGE OF THE APPLICABLE LIMITED WARRANTIES SET FORTH ABOVE. Some States do not allow limitations on how long an implied warranty lasts, so the above limitation may not apply to you.

### How Does State Law Affect Warranty Coverage?

This warranty gives you specific legal rights. You may also have other rights which vary from state to state.

Here are the tools you'll need to complete your installation:

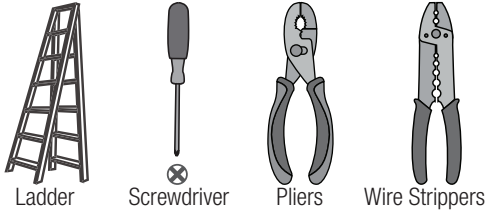

### OPTIONAL

If mounting to a support structure, you will also need these tools.

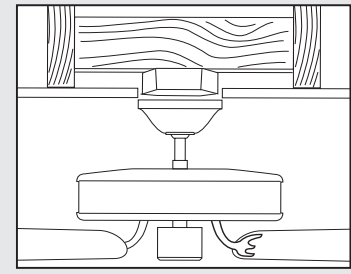
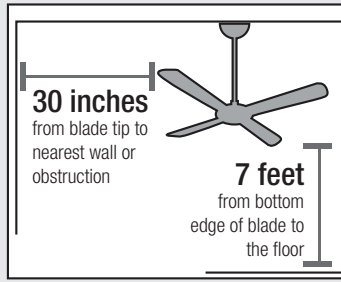
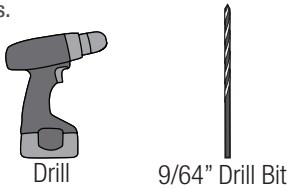

You must be able to secure the fan to building structure or fan-rated outlet box.

Preparation

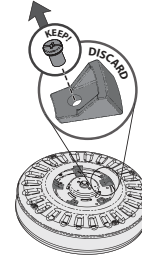
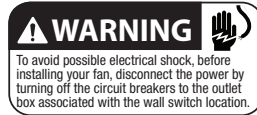
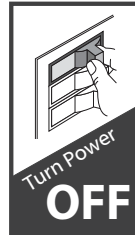

Remove the shipping blocks from the motor. Save the screws. They will be needed for blade iron installation.

## Assembly Instructions

STEP 1

### OPTION 1: Machine Screws

Use machine screws (provided with outlet box) and washers when securing to existing ceiling fan-rated outlet box. Make sure it is securely installed and is acceptable for fan support of 31.8 kg (70 lbs) or less.

### OPTION 2: Wood Screws

Use wood screws and washers (included) when securing to support structure with approved electrical outlet box. Drill 9/64" pilot holes in support structure to aid in securing ceiling bracket with hardware found in the ★ hardware bag.



For installing the hanger bracket and wiring the fan x2

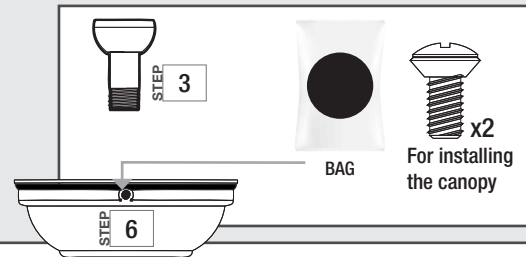
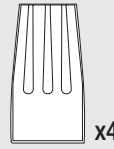

STEP 4

Place the downrod ball into the slot in the ceiling bracket.

### NOTICE

To prevent damage to fan, ALWAYS lift holding either the fan housing or the downrod.

STEP 5 See back for wiring

### WARNING

#### FAN FALL HAZARD

- To prevent SERIOUS INJURY or DEATH:
- ALWAYS tighten setscrew with pliers.
- DO NOT hand tighten setscrew.
- CHECK the setscrew is tight using pliers each time you change fan direction.

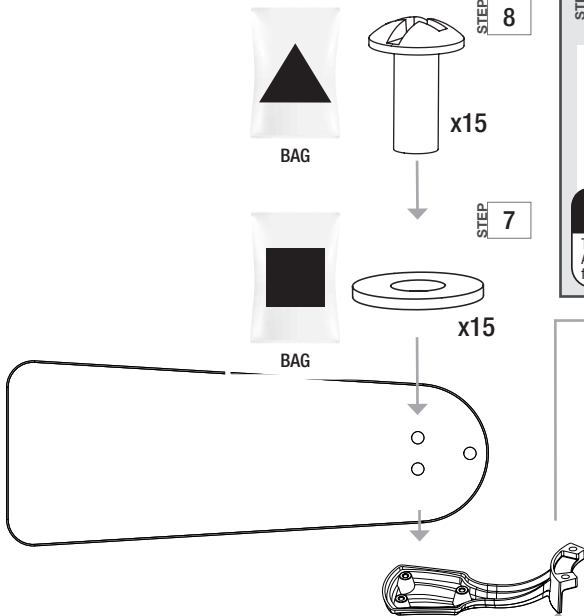

For installing the blades x5

You will find these screws in the motor's shipping blocks.



STEP 16 Connect the fan pull chain pendant to the short chain coming from the switch housing.

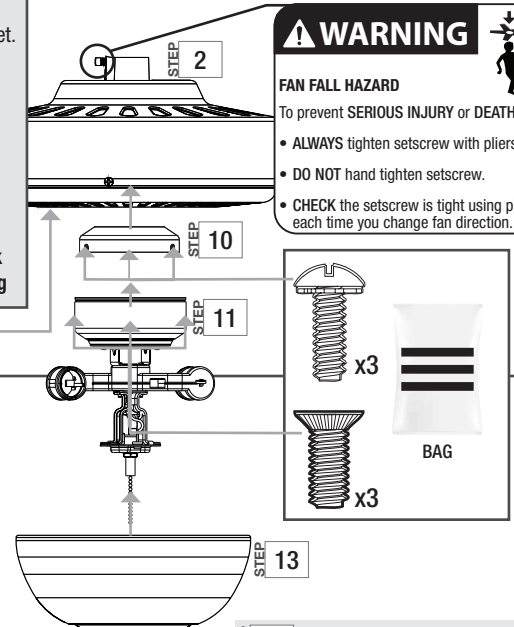

For installing the light kit

Single switch:

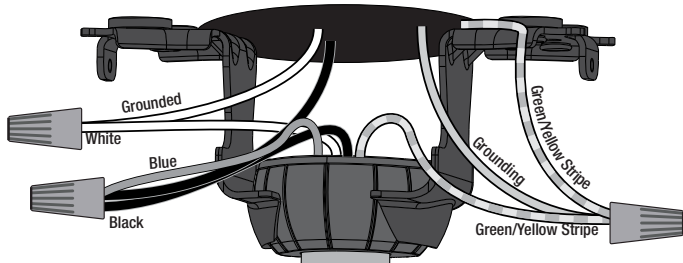

**WARNING**  
The ceiling fan must be grounded. If the ground wire for the installation site is not present, immediately **STOP** installation and consult a qualified electrician.

**WARNING**  
All wiring must be in accordance with national and local electrical codes ANSI/NFPA 70. If you are unfamiliar with wiring or in doubt, consult a qualified electrician.

1. Connect the three grounding wires (green, green/yellow stripe, or bare copper) coming from the ceiling, downrod, and hanging bracket.
2. Connect the white (grounded) wire from the ceiling to the white wire from the fan.
3. Connect the black (ungrounded) wire from the ceiling to the black wire and blue wire from the fan.

Dual switches:

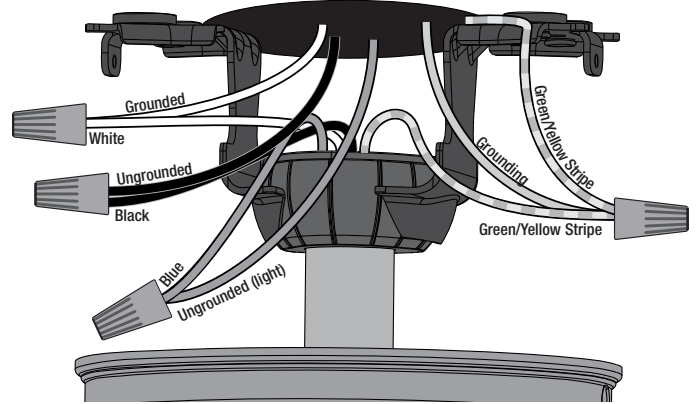

1. Connect the three grounding wires (green, green/yellow stripe, or bare copper) coming from the ceiling, downrod, and hanging bracket.
2. Connect the white (grounded) wire from the ceiling to the white wire from the fan.
3. Connect the black (ungrounded) wire from the ceiling to the black wire from the fan.
4. Connect the second ungrounded (light) wire from the ceiling to the blue wire from the fan.

**Note:** To connect the wires, hold the bare metal leads together and place a wire connector over them, then twist clockwise until tight. Turn the splices upward and push them carefully back through the hanger bracket into the outlet box. Spread the wires apart, with the grounded wires on one side of the outlet box and the ungrounded wires on the other side of the outlet box.

Troubleshooting

Fan Doesn't Work

- Make sure power switch is on.
- Pull the pull chain to make sure it is on.
- Push the motor reversing switch firmly left or right to ensure that it is engaged.
- Check the circuit breaker to ensure the power is turned on.
- Make sure the blades spin freely.
- Turn off power from the circuit breaker, then loosen the canopy and check all the connections according to the wiring diagram.
- Check the plug connection in the switch housing.

Excessive Wobbling

- Make sure the blades are properly installed on the blade iron posts.
- Turn the power off, support the fan carefully, and check that the hanger ball is properly seated.
- Use the provided balancing kit and instructions to balance the fan.

Noisy Operation

- Make sure the blades are properly installed.
- Check to see if any of the blades are cracked. If so, replace all of the blades.

Down Rod

If you need a different downrod length follow these steps:

Follow steps 1-5 to remove standard downrod pipe

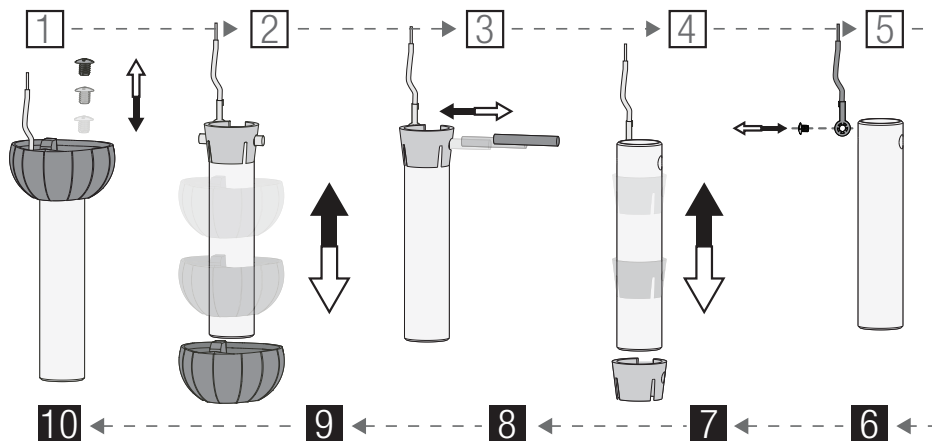

Follow steps 6-10 to reassemble with new downrod

**WARNING**  
**FAN FALL HAZARD**  
To prevent **SERIOUS INJURY** or **DEATH**:  
• **ALWAYS** follow the downrod assembly instructions exactly.  
• **VERIFY** the downrod is assembled correctly by firmly pulling on the hanger ball.