

ENGLISH

Canon

DIGITAL
IXUS 970 IS

Camera User Guide



Getting Started

p. 9

Ensure that you read the Safety Precautions (pp. 205 – 213).

DiGiC III



Exif Print



Confirming the Package Contents

The following items are included in the package. If something is missing please contact the retail outlet at which you purchased the product.

1 Camera

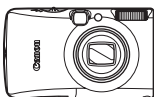

2 Battery Pack NB-5L
(With Terminal Cover)



3 Battery Charger
CB-2LX/CB-2LXE

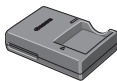

4 Memory Card
(32 MB)



5 Interface Cable
IFC-400PCU

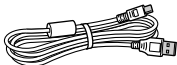

6 AV Cable
AVC-DC400

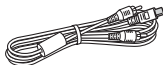

7 Wrist Strap
WS-DC2



8 Canon Digital
Camera Solution
Disk



9 European
Warranty System
(EWS) Booklet



10 User Guides



Getting Started Guide



Canon Digital Camera
Manuals Disk

- "Use of Genuine Canon Accessories Recommended" Leaflet

You may not be able to achieve the full performance of this camera with the included memory card.

Let's Get Started!

This guide is divided into the following two sections.

First...

Getting Started

p. 9

This section explains how to prepare the camera for use and the basics of shooting, viewing and printing images. Start out by familiarizing yourself with the camera and mastering the basics.

Next...

Learning More

p. 39

Once you have mastered the basics, use the camera's many features to shoot more challenging photos. Details on using each function are described in this section, including how to connect the camera to a television to view images, and how to make My Camera settings.



The PDF Manuals are included in the supplied CD-ROM.

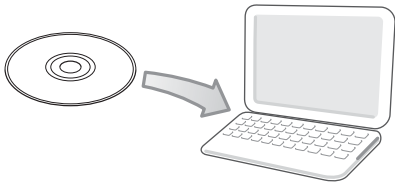

Adobe Reader is required to view the PDF Manuals.
<http://www.adobe.com>

Table of Contents

Items marked with a ☆ are lists or charts that summarize camera functions or procedures.

Please Read	7
-------------------	---

Getting Started 9

Preparations	10
Shooting Still Images (📷 Mode)	16
Viewing Still Images	18
Erasing	19
Printing	20
Embedding the Date in the Image Data	22
Shooting Movies (🎥 Standard Mode)	24
Viewing Movies	26
Downloading Images to a Computer	27
System Map	34

Learning More 39

Components Guide 40











Using the Control Dial	43
Using the (⏪) Button	44
How to Use the Mode Dial	45
Indicators	46

Basic Operations 48

☆ Menus and Settings	48
☆ Information Displayed on the LCD Monitor and Menus ...	50
Using the LCD Monitor	60

Commonly Used Shooting Functions 62

🔍 📷 Using the Optical Zoom	62
Using the Digital Zoom/ Digital Tele-Converter	62
Magnified Close-Up Shooting (Digital Macro)	66

 Using the Flash	66
  Shooting Close-Ups/Infinity	67
 Using the Self-Timer	68
Changing the Recording Pixels (Still Images)	70
Changing the Compression (Still Images)	71
Setting the Image Stabilizer Function	72
 Adjusting the ISO Speed	74
Advanced Shooting Functions	75
<hr/>	
Shooting Modes for Specific Scenes	75
Shooting in Manual Mode	78
 Continuous Shooting	78
Setting the Flash	80
 Movie Shooting	82
Shooting Panoramic Images (Stitch Assist)	88
Checking the Focus and Peoples' Expressions	90
Selecting an AF Frame Mode	93
Selecting a Subject to Focus On (Face Select and Track)	96
Shooting Hard-to-Focus Subjects (Focus Lock, AF Lock)	97
Locking the Exposure Setting (AE Lock)	99
Locking the Flash Exposure Setting (FE Lock)	100
Adjusting the Exposure Compensation	101
Switching between Metering Modes	102
Setting the Shutter Speed (Long Shutter Mode)	103
Adjusting the Tone (White Balance)	104
Shooting in a My Colors Mode	107
Changing the Colors and Shooting	109
Setting the Display Overlays	114
Categorizing Images Automatically (Auto Category)	115
Registering Settings to the  Button	116
Playback/Erasing	118
<hr/>	
 Viewing Magnified Images	118
 Viewing Images in Sets of Nine (Index Playback)	119
Checking the Focus and Peoples' Expressions (Focus Check Display)	120
 Jumping to Images	122

Organizing Images by Category (My Category)	124
Trimming a Portion of an Image	127
Viewing Movies	129
Editing Movies	131
Rotating Images in the Display	134
Playback with Transition Effects	135
Automated Playback (Slide Shows)	136
Red-Eye Correction Function	142
Adding Effects with the My Colors Function	147
Resizing Images	149
Attaching Sound Memos to Images	151
Sound-Only Recording (Sound Recorder)	152
Protecting Images	154
Erasing Images	158
Registering Functions to the  Button	163
Print Settings/Transfer Settings	165
Setting the DPOF Print Settings	165
Setting the DPOF Transfer Settings	172
Configuring the Camera	174
Power Saving Function	174
Setting the World Clock	175
Formatting Memory Cards	178
Resetting the File Number	179
Creating an Image Destination (Folder)	181
Setting the Auto Rotate Function	183
Resetting Settings to Their Default Values	184
Connecting to a TV	186
Shooting/Playback Using a TV	186
Customizing the Camera (My Camera Settings)	188
Changing My Camera Settings	188
Registering My Camera Settings	189
Troubleshooting	191

List of Messages	201
<hr/>	
Appendix	205
<hr/>	
Safety Precautions	205
Preventing Malfunctions	210
Using the AC Adapter (Sold Separately)	214
Using an Externally Mounted Flash (Sold Separately)	215
Camera Care and Maintenance	217
Specifications	218
Index	228
<hr/>	
 Functions Available in Each Shooting Mode	232
<hr/>	

Please Read

Test Shots

Before you try to photograph important subjects, we highly recommend that you shoot several trial images to confirm that the camera is operating and being operated correctly.

Please note that Canon Inc., its subsidiaries and affiliates, and its distributors are not liable for any consequential damages arising from any malfunction of a camera or accessory, including memory cards, that results in the failure of an image to be recorded or to be recorded in a way that is machine readable.

Warning Against Copyright Infringement

Please note that Canon digital cameras are intended for personal use and should never be used in a manner that infringes upon or contravenes international or domestic copyright laws and regulations. Please be advised that in certain cases the copying of images from performances, exhibitions, or commercial properties by means of a camera or other device may contravene copyright or other legal rights even if the image was shot for personal use.

Warranty Limitations

For information on your camera's warranty, please refer to the Canon European Warranty System (EWS) Booklet supplied with your camera. **For Canon Customer Support contacts, please see the European Warranty System (EWS) Booklet.**

Camera Body Temperature

If your camera is used for prolonged periods, the camera body may become warm. Please be aware of this and take care when operating the camera for an extended period.

About the LCD Monitor

The LCD monitor is produced with extremely high-precision manufacturing techniques. More than 99.99% of the pixels operate to specification. Less than 0.01% of the pixels may occasionally misfire or appear as red or black dots. This has no effect on the recorded image and does not constitute a malfunction.

Video Format

Please set the camera's video signal format to the one used in your region before using it with a TV monitor ([p. 186](#)).

Language Setting

Please see *Setting the Display Language* ([p. 15](#)) to change the language setting.

Getting Started

- **Preparations**
- **Shooting Still Images**
- **Viewing Still Images**
- **Erasing**
- **Printing**
- **Embedding the Date in the Image Data**
- **Shooting Movies**
- **Viewing Movies**
- **Downloading Images to a Computer**
- **System Map**

Preparations

Charging the Battery

1. Insert the battery into the battery charger.

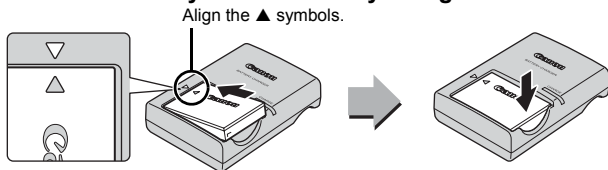

2. Plug the battery charger (CB-2LX) into a power outlet, or attach the power cord to the battery charger (CB-2LXE) and plug it into a power outlet.

Battery charger model names and types vary by region.

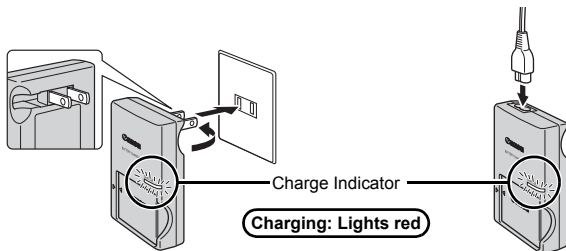

3. Remove the battery after charging is complete.

Charging takes approximately 2 hours 5 minutes.

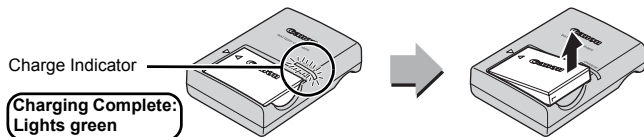

To protect the battery and prolong its life, do not charge it for longer than 24 hours continuously.

Installing the Battery and Memory Card

1. Slide the cover (①) and open it (②).

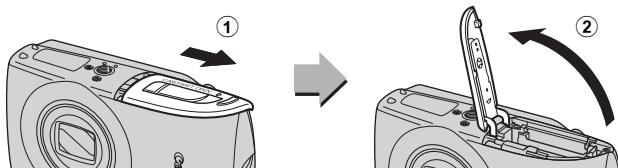

2. Insert the battery.

It will lock into place with a click.

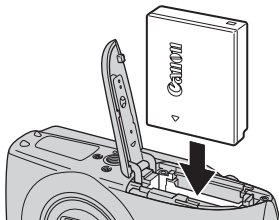

3. Insert the memory card until it clicks into place.

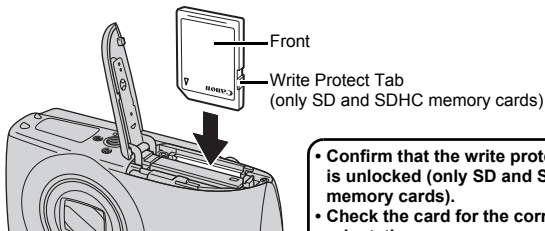

- Confirm that the write protect tab is unlocked (only SD and SDHC memory cards).
- Check the card for the correct orientation.

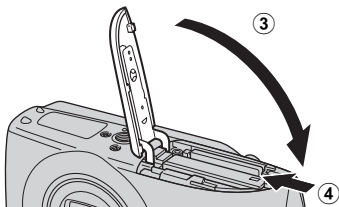

Ensure that the memory card is correctly oriented before inserting it in the camera. Inserting it backward may cause the camera to fail to recognize the memory card or to malfunction.

4. Close the cover (③, ④).**To Remove the Battery**

Press the battery lock in the direction of the arrow (①) and pull the battery out (②).

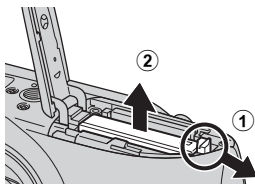
**To Remove the Memory Card**

Push the memory card with your finger or the toggle on the wrist strap until the memory card clicks and then release it.

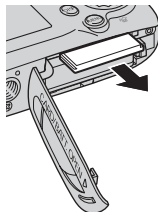
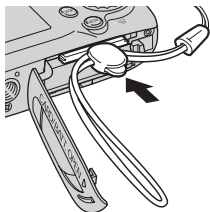
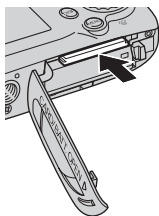

Attaching the Wrist Strap

Use the wrist strap to avoid dropping the camera during use.

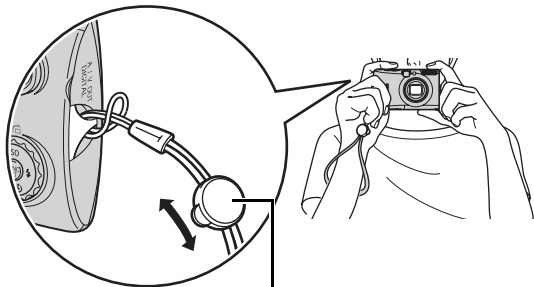

Toggle

The toggle's position on the strap can be changed. The toggle can be used to open the terminal cover and when inserting or removing a memory card.

Opening the Terminal Cover

Hook your fingernail or the wrist strap toggle under the left edge of the terminal cover and open it to the right.

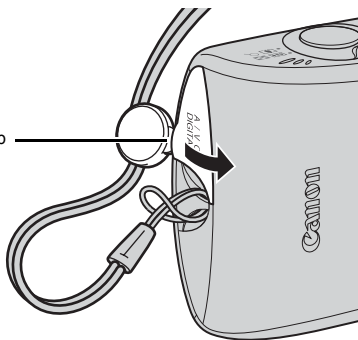

Setting the Date and Time

The Date/Time settings menu will appear the first time the power is turned on.

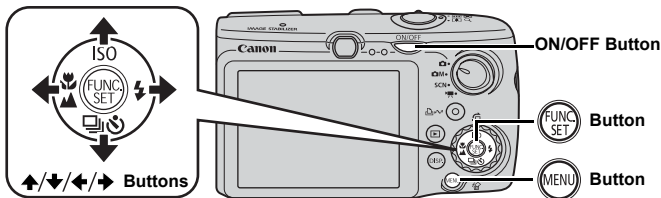

1. Press the ON/OFF button.
2. Select the month, day, year and time, and the display order.
 1. Use the \leftarrow or \rightarrow button to select an option.
 2. Use the \uparrow or \downarrow button to set the value.
3. Press the button.

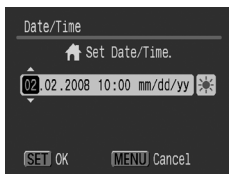

To Change a Previously Set Date/Time

Use the following procedures to display the Date/Time settings menu, and then perform Steps 2 and 3 above.

1. Press the button.
2. Use the \leftarrow or \rightarrow button to select the (Set up) menu.
3. Use the \uparrow or \downarrow button to select [Date/Time].
4. Press the button.





- A rechargeable lithium battery is built into the camera to save such settings as the date/time. Insert a charged battery into the camera. Or if you use the separately sold AC Adapter Kit ACK-DC30, the battery will charge in about four hours. It will charge even if the camera is turned off.
- The date/time settings may be lost after approximately three weeks if you remove the main battery. Reset the date/time settings if this occurs.

Setting the Display Language

You can change the language displayed in the LCD monitor menus and messages.

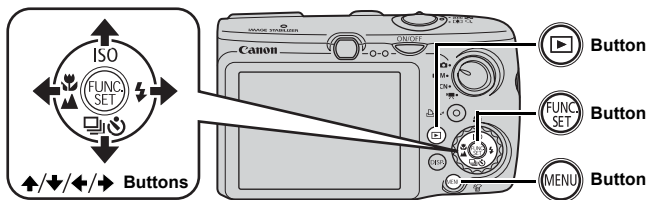

1. Press the button.
2. Hold down the button and press the button.
3. Use the , , or button to select a language.
4. Press the button.

Shooting Still Images (📷Mode)

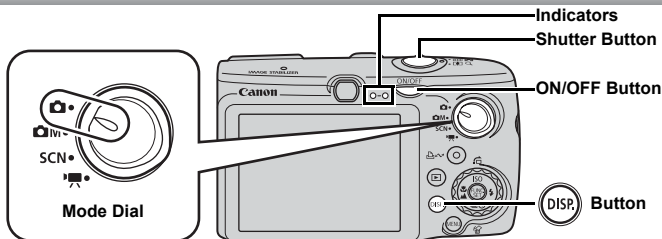

1. Press the ON/OFF button.

- The start-up sound will play and the start-up image will display in the LCD monitor.
- Pressing the ON/OFF button again turns the power off.

2. Select a shooting mode.

1. Set the mode dial to 📷 (Auto).

3. Aim the camera at the subject.



Avoiding Camera Shake

Keep your arms tight against your body while holding the camera firmly by the sides. Using a tripod is also effective.

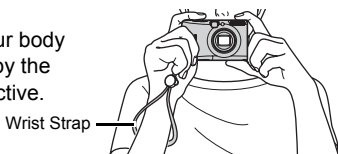

Use the wrist strap to avoid dropping the camera during use.

4. Press the shutter button lightly (halfway) to focus.

- When the camera focuses, it beeps twice and the indicator lights green (orange when the flash fires).

5. Press the shutter button fully (all the way) to shoot.

- The shutter sound will play once and the image will record.
- Recorded images are displayed on the LCD monitor for approximately 2 seconds immediately after shooting (Rec. Review). You can shoot by pressing the shutter button even when an image is being displayed.
- If you hold the shutter button down after a shot, the image will continue to display.
- The indicator will blink green and the file will record to the memory card.

To Shoot Images in Focus

The camera automatically sets the focus when you press the shutter button halfway*.

* The shutter button has a two-stage action. Pressing it down to the first stage is referred to as “pressing halfway”.

Correct

Press halfway to set the focus

Press fully

Incorrect

Just pressing fully

AF Frame

An AF frame will display in green on the LCD monitor at the point of focus.



Mute Setting

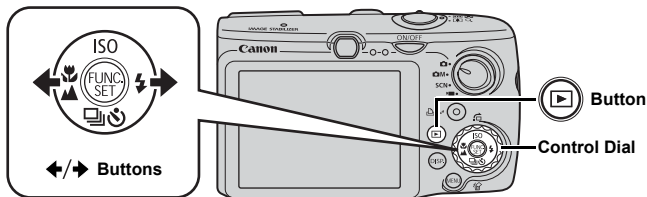

Pressing the **DISP.** button while turning on the camera power will silence all camera sounds except for warning sounds. You can change the setting in [Mute] in the **11** (Set up) menu (p. 57).

Viewing Still Images



1. Press the  button.

2. Use the  or  button to display the image you wish to view.

- Use the  button to move to the previous image and the  button to move to the next image.
- The images advance more quickly if you keep the button pressed, but they will appear coarse.
- You can also select images by using the control dial. Turning it counterclockwise displays the previous image while turning it clockwise displays the next image.



- Setting [Resume] to either [Last seen]* or [Last shot] in the  menu allows you to specify the image to display in playback mode. (* Default setting). If you select [Last seen], the last image viewed will display (Resume Playback).
- The following actions will display the most recent image regardless of the [Resume] settings. Shooting an image, changing the memory card, or editing an image on the memory card using a computer.

Erasing

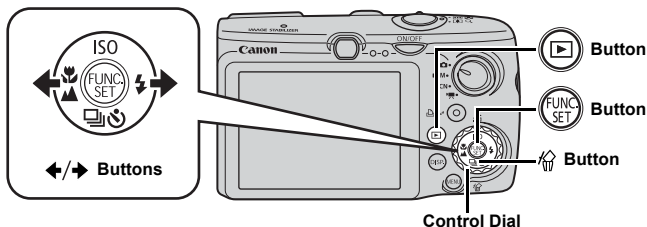

1. Press the button.
2. Use the or button to select an image to erase and press the button.

You can also select images by using the control dial.

3. Confirm that [Erase] is selected and press the button.

To exit instead of erasing, select [Cancel].



Please note that erased images cannot be recovered. Exercise adequate caution before erasing an image.

Printing

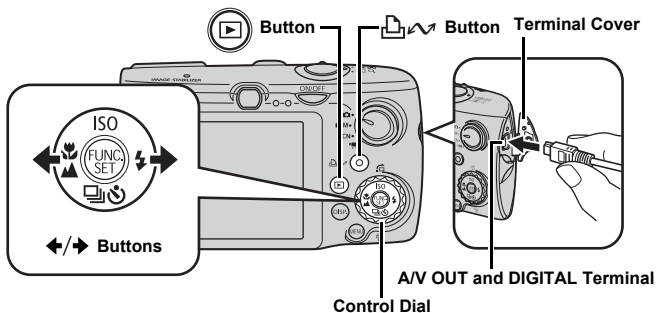

1. Connect the camera to a direct print compatible printer.

- Slip your fingernail or the toggle on the wrist strap under the left edge of the terminal cover to open it and insert the interface cable all the way into the connector.
- See the printer's user guide for connection instructions.
- Since this camera uses a standard protocol (PictBridge), you can use it with other PictBridge-compliant printers in addition to Canon-brand printers.
For detail, see the *Direct Print User Guide*.

2. Turn on the printer.

3. Press the camera's button to turn on the power.

- The  button will light blue.

4. Use the or button to select an image to print and press the button.

- The  button will blink blue and printing will start.
- You can also select images by using the control dial.
- After you finish printing, turn off the camera and the printer and disconnect the interface cable.





Printing from a Print List



You can add images directly to a print list by merely pressing the  button immediately after shooting or playing back an image. You can then print the images from the print list easily, when connecting the camera to a printer.

Add to the Print List

1. Press the  button (still images only).

2. Add to the print list.

1. Use the  or  button to select the number of print copies.
2. Use the  or  button to select [Add].
3. Press the  button.

- To remove an image from the print list, press the  button again, use the  or  button to select [Remove] and press the **FUNC./SET** button.

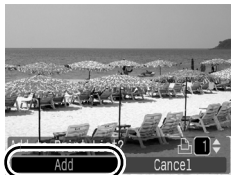





Printing Images in a Print List

This explanation is based on the use of a Canon SELPHY ES series or SELPHY CP series printer.

1. Connect the camera to the printer.

2. Print the image.

1. Use the  or  button to select [Print now].

- You can use the  or  button to confirm the images added to the print list.

2. Press the  button.

- Printing will start.
- If printing is halted and resumed, printing will start from the next image in the queue.

Number of copies to print



Embedding the Date in the Image Data

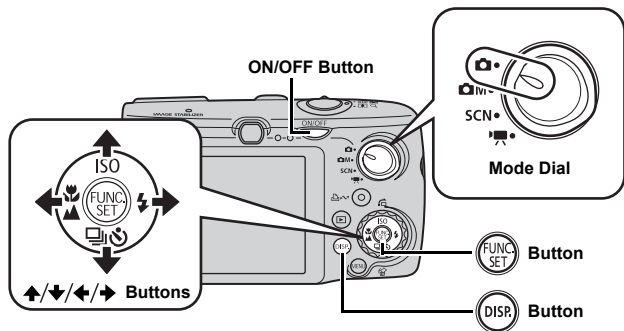





This section explains how to embed date information on images as they are recorded (Date Stamp).







- The date stamp cannot be deleted from the image data once it has been embedded. Ensure that the camera's date/time is set correctly beforehand (p. 14).
- The image size is fixed to the 2M (1600 × 1200) setting and the compression to Fine (appropriate for printing L-size or postcard-size prints.)



1. Press the ON/OFF button.

2. Set the mode dial to (Auto).

- You can also make this setting in  (except ,  and ) and **SCN** (except ) modes.

3. Select (Date Stamp).

1. Press the  button.
2. Use the  or  button to select .
3. Use the  or  button to select .

- The area that will not print displays in gray.
- Press the **DISP.** button to switch to [Date & Time] with the  or  button.





You can use the following methods to imprint the date on images lacking imprinted date stamps.

- Set with the camera's Digital Print Order Format (DPOF) function. Set [Date] option to [On] in [Print Settings] in the  (Print) menu.
- Connect the camera to a printer and imprint the date. See the *Direct Print User Guide*.
- Insert a memory card into the printer and imprint the date. See your printer user guide.
- Use the supplied software. See the *Software Starter Guide*.

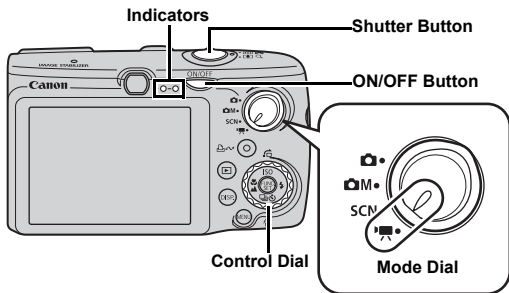
Shooting Movies (Standard Mode)



- 1.** Press the ON/OFF button.
- 2.** Select a shooting mode.
 1. Set the mode dial to  (Movie).
 2. Use the control dial to select  (Standard).
- 3.** Aim the camera at the subject.



- Do not touch the microphone while recording.
- Do not press any buttons other than the shutter button. The sound that buttons make will be recorded in the movie.

Microphone

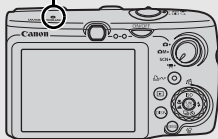

4. Press the shutter button halfway to focus.

- When the camera focuses, it beeps twice and the indicator lights green.
- The exposure, focus and white balance are automatically set.



5. Press the shutter button fully to shoot.

- Recording starts.
- During the recording, the elapsed recording time and [●Rec.] will display in the LCD monitor.

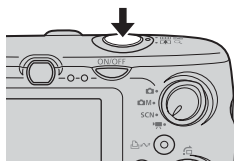

Elapsed Time

6. Press the shutter button fully again to stop recording.

- The indicator will blink green and the data will be recorded onto the memory card.
- Recording will stop automatically when the maximum recording time elapses, or the built-in memory or memory card become full.

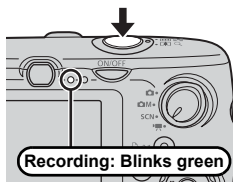

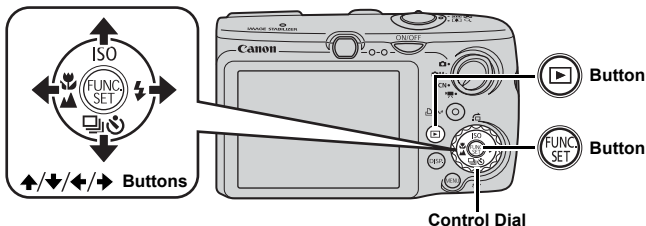

Recording: Blinks green

Viewing Movies





1. Press the  button.

2. Use the  or  button to display a movie and press the  button.

- Images with a   icon are movies.
- You can also select images by using the control dial.



3. Use the  or  button to select  (Play) and press the  button.

- The movie will start playing.
- If you press the **FUNC./SET** button during playback, you can pause and restart the movie.
- You can adjust the playback volume with the  or  button.



Downloading Images to a Computer

We recommend to use the supplied software.

Items to Prepare

- Camera and computer
- Canon Digital Camera Solution Disk supplied with the camera
- Interface cable supplied with the camera

System Requirements

Please install the software on a computer meeting the following minimum requirements.

■ Windows

OS	Windows Vista Windows XP Service Pack 2 Windows 2000 Service Pack 4
Computer Model	The above OS should be pre-installed on computers with built-in USB ports.
CPU	Windows Vista : Pentium 1.3 GHz or higher Windows XP / Windows 2000 : Pentium 500 MHz or higher
RAM	Windows Vista : 512 MB or more Windows XP / Windows 2000 : 256 MB or more
Interface	USB
Free Hard Disk Space	<ul style="list-style-type: none"> • Canon Utilities - ZoomBrowser EX : 200 MB or more - PhotoStitch : 40 MB or more • Canon Camera TWAIN Driver : 25 MB or more
Display	1,024 × 768 pixels/High Color (16 bit) or better

■ Macintosh

OS	Mac OS X (v10.3 – v10.4)
Computer Model	The above OS should be pre-installed on computers with built-in USB ports.
CPU	PowerPC G3/G4/G5 or Intel Processor
RAM	256 MB or more
Interface	USB
Free Hard Disk Space	<ul style="list-style-type: none"> • Canon Utilities - ImageBrowser : 300 MB or more - PhotoStitch : 50 MB or more
Display	1,024 × 768 pixels/ 32,000 Colors or better

Preparing to Download Images

With Windows 2000, ensure that you install the software first before connecting the camera to the computer.

1. Installing the software.

■ Windows

1. Place the Canon Digital Camera Solution Disk in the computer's CD-ROM drive.
2. Click [Easy Installation].
Follow the onscreen messages to proceed with the installation.



3. Click [Restart] or [Finish] once the installation is complete.

When the installation is finished, [Restart] or [Finish] will display. Click the button that appears.



4. Remove the CD-ROM from the drive when your normal desktop screen appears.

■ Macintosh

Double-click the  icon in the CD-ROM window. When the installer panel appears, click [Install]. Follow the onscreen instructions to proceed.



2. Connecting the camera to a computer.

1. Connect the supplied interface cable to the computer's USB port and to the camera's A/V OUT and DIGITAL terminal.

Slip your fingernail or the toggle on the wrist strap under the left edge of the terminal cover to open it and insert the interface cable all the way into the connector.

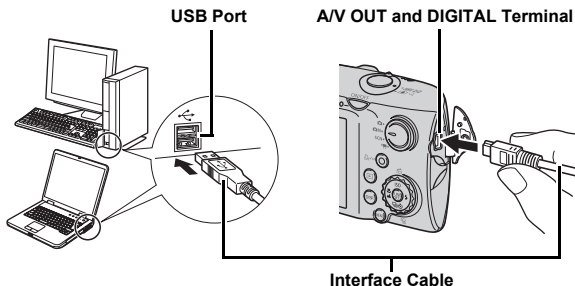

3. Preparing to download images to the computer.

1. Press the  button to turn the camera on.

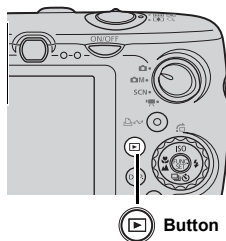

If the Digital Signature Not Found window appears, click [Yes]. The USB driver will automatically finish installing onto the computer when you attach the camera and open a connection.

4. Open the CameraWindow.

■ Windows

Select [Canon CameraWindow] and click [OK].

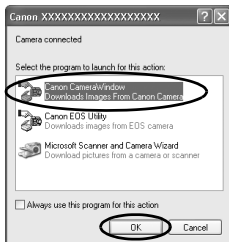

If the window above does not appear, click the [Start] menu and select [All Programs] or [Programs], followed by [Canon Utilities], [CameraWindow], [CameraWindow] and [CameraWindow].

CameraWindow appears.

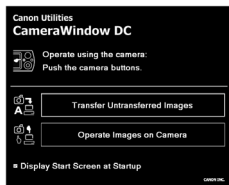

■ Macintosh

The CameraWindow will appear when you establish a connection between the camera and computer. If it fails to appear, click the [CameraWindow] icon on the Dock (the bar which appears at the bottom of the desktop).

Preparations for downloading images are now finished. Please proceed to the *Downloading Images Using the Camera* section (p. 31) (except Windows 2000).



- Refer to the *Software Starter Guide* for details on downloading images using the computer.
- With Windows 2000, you can download images using the computer.

Downloading Images Using the Camera (Direct Transfer)

Use this method to download images using camera operations (except Windows 2000).

Install the software before downloading images via the direct transfer method for the first time (p. 28).

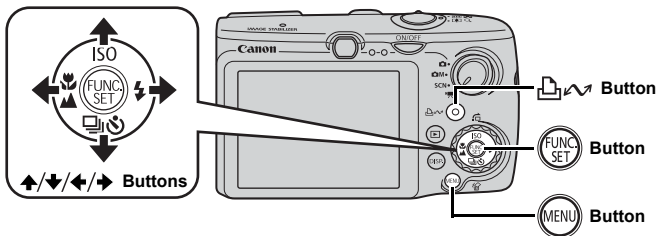

1. Confirm that the Direct Transfer menu is displayed on the camera's LCD monitor.

- The  button will light blue.
- Press the **MENU** button if the Direct Transfer menu fails to appear.







Direct Transfer Menu

2. Press the button.

- Images not previously downloaded will download to the computer.

You can also use the following options in the Direct Transfer menu to set the method for downloading images.

	All Images	Transfers and saves all images to the computer.
	New Images	Transfers and saves to the computer only the images that have not been previously transferred.
	DPOF Trans. Images	Transfers and saves to the computer only the images with DPOF Transfer Order settings.
	Select & Transfer	Transfers and saves single images to the computer as you view and select them.
	Wallpaper	Transfers and saves single images to the computer as you view and select them. The transferred images display as the background on the computer desktop.







All Images/New Images/DPOF Trans. Images

1. Use the  or  button to select ,  or  and press the  button.

- The images will download. The  button will blink blue while downloading is in progress.
- The display will return to the Direct Transfer menu when the download is complete.
- Pressing the **FUNC./SET** button will cancel a download in progress.



Select & Transfer/Wallpaper

1. Use the  or  button to select  or  and press the  button (or  button).

2. Use the **←** or **→** button to select images to download and press the button.

- The images will download. The  button will blink blue while downloading is in progress.



3. Press the button after downloading finishes.

- You will return to the Direct Transfer menu.



Only JPEG images can be downloaded as wallpaper for a computer.



The option selected with the  button is retained even when the camera's power is turned off. The previous setting will be in effect the next time the Direct Transfer menu is displayed. The image selection screen will appear directly when the [Select & Transfer] or the [Wallpaper] option was last selected.

Click [x] at the bottom right of the window to close CameraWindow, the downloaded images will display on the computer.

■ Windows

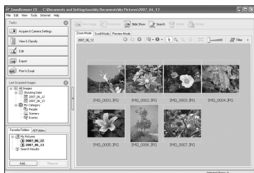

ZoomBrowser EX

■ Macintosh



ImageBrowser

By default, the downloaded images are saved into folders according to their shooting dates.

System Map

Supplied with Camera

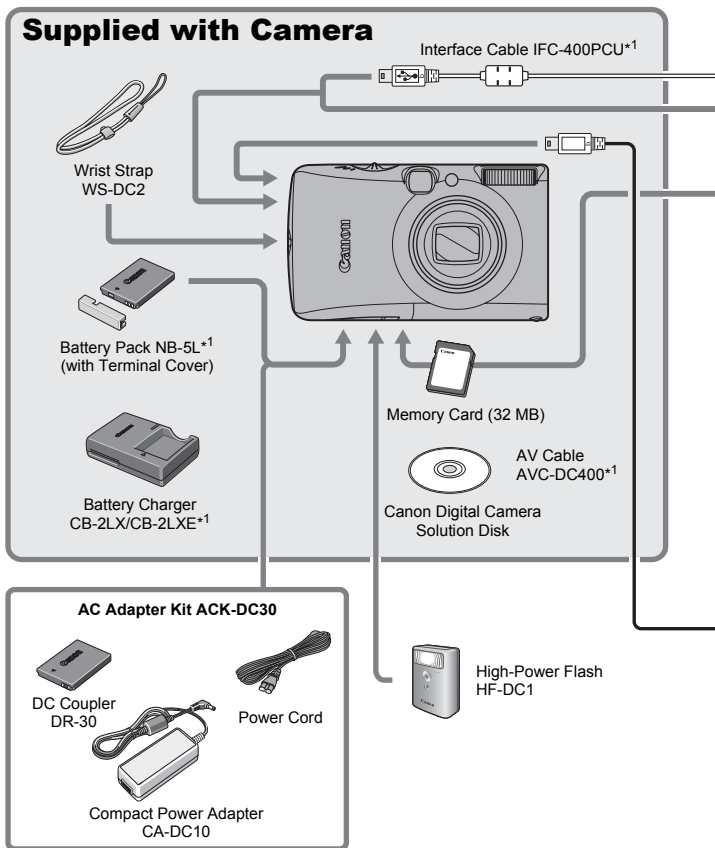

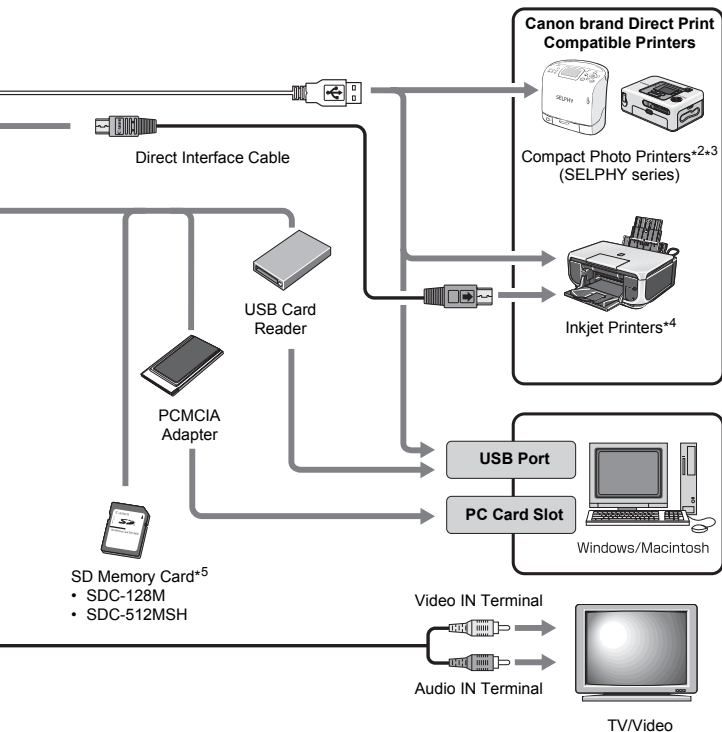

SD Memory Card*⁵

- SDC-128M
- SDC-512MSH

*1 Also available for purchase separately.

*2 See the user guide supplied with the printer for more information on the printer.

*3 This camera can also be connected to the Card Photo Printer CP-10/CP-100/CP-200/CP-300.

*4 See the user guide supplied with the inkjet printer for more information on the printer and interface cables.

*5 Not sold in some regions.

Optional Accessories

The following camera accessories are sold separately. Some accessories are not sold in some regions, or may no longer be available.

Flash

- **High-Power Flash HF-DC1**

This attachable supplementary flash can be used to capture photographic subjects that are too distant for the built-in flash to illuminate.

Power Supplies

- **AC Adapter Kit ACK-DC30**

This kit lets you power the camera from any standard household power outlet. Recommended to power a camera for an extended period of time or when connecting to a computer. (Cannot be used to charge the camera battery.)

- **Battery Charger CB-2LX/CB-2LXE**

An adapter for charging Battery Pack NB-5L.

- **Battery Pack NB-5L**

Rechargeable lithium-ion battery.

Other Accessories

- **SD Memory Card**

SD memory cards are used to store images recorded by the camera. Canon brand cards are available in 128 MB and 512 MB capacities.

- **Interface Cable IFC-400PCU**

Use this cable to connect the camera to a computer, Compact Photo Printer (SELPHY series), or to a inkjet printer (refer to your inkjet printer user guide).

- **AV Cable AVC-DC400**

Use this cable to connect the camera to a TV set.

Direct Print Compatible Printers

Canon offers the following separately sold printers for use with the camera. You can produce photo quality prints quickly and easily by connecting them to the camera with a single cable and operating the camera's controls.

- **Compact Photo Printers (SELPHY series)**
- **Inkjet Printers**

For more information, visit your nearest Canon retailer.

Use of genuine Canon accessories is recommended.

This product is designed to achieve excellent performance when used with genuine Canon accessories. Canon shall not be liable for any damage to this product and/or accidents such as fire, etc., caused by the malfunction of non-genuine Canon accessories (e.g., a leakage and/or explosion of a battery pack). Please note that this warranty does not apply to repairs arising out of the malfunction of non-genuine Canon accessories, although you may request such repairs on a chargeable basis.



Learning More

Components Guide

■ Front View

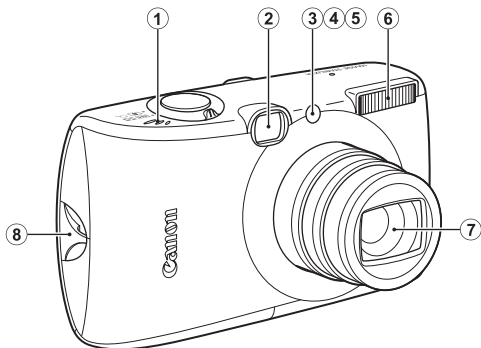

- ① Speaker
- ② Viewfinder Window (p. 41)
- ③ AF-assist Beam (p. 55)
- ④ Red-Eye Reduction Lamp (p. 80)
- ⑤ Self-Timer Lamp (p. 68)
- ⑥ Flash (p. 66)
- ⑦ Lens
- ⑧ Wrist Strap Mount (p. 13)

■ Back View

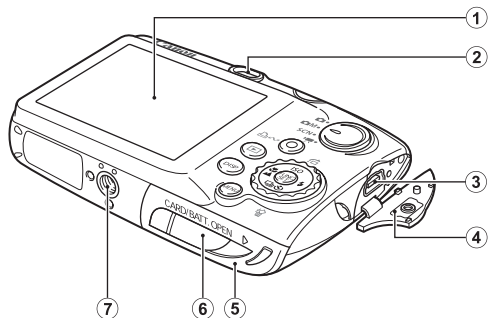

- ① LCD Monitor (p. 60)
- ② Viewfinder
- ③ AV OUT (Audio/Video output) and DIGITAL Terminal (pp. 20, 29, 186)
- ④ Terminal Cover (p. 13)
- ⑤ Memory Card Slot / Battery Cover (p. 11)
- ⑥ DC Coupler Terminal Cover (p. 214)
- ⑦ Tripod Socket

Using the Viewfinder

The viewfinder can be used to conserve power by turning the LCD monitor off (p. 60) while shooting.



The LCD monitor may be covered with a thin plastic film for protection against scratches during shipment. If so, remove the film before using the camera.

■ Controls

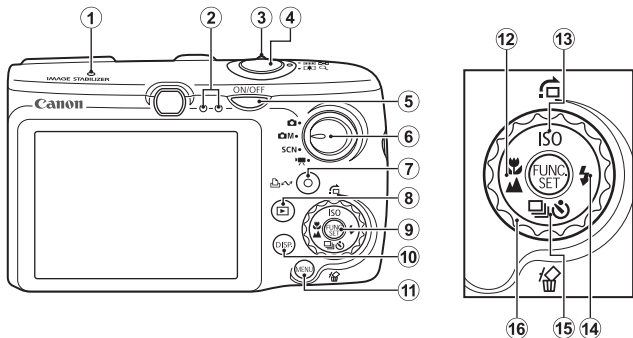

- ① Microphone (pp. 24, 151)
- ② Indicator (p. 46)
- ③ Zoom Lever (pp. 62, 118)
Shooting: (Wide Angle)/ (Magnify)
Playback: (Index)/ (Magnify)
- ④ Shutter Button (pp. 16, 24)
- ⑤ ON/OFF Button (p. 14)
- ⑥ Mode Dial (pp. 16, 24, 45)
- ⑦ (Print/Share) Button (pp. 20, 31, 116)
- ⑧ (Playback) Button (pp. 18, 26, 44)
- ⑨ **FUNC./SET** (Function/Set) Button (p. 48)
- ⑩ **DISP.** (Display) Button (p. 60)
- ⑪ **MENU** Button (p. 49)
- ⑫ (Macro)/ (Infinity)/ Button (p. 67)
- ⑬ **ISO**/ (Jump)/ Button (pp. 74, 122)
- ⑭ (Flash)/ Button (p. 66)
- ⑮ (Continuous)/ (Self-timer)/ (Single Image Erase)/ Button (pp. 19, 68, 78)
- ⑯ Control Dial (p. 43)

Using the Control Dial

Turning the control dial counterclockwise is equivalent to pressing the ◀ button, while turning the control dial clockwise is equivalent to pressing the ▶ button (it is equivalent to pressing the ▲ or ▼ button with some functions).

You can perform the following operations when you turn the control dial.



Operation is carried out using control dial.

Disappears after a few seconds.

■ The Shooting Functions

- Selecting the shooting modes (pp. 75, 82)
- Selecting ⚡/🌸/▲/📷/🕒/ISO (pp. 66, 67, 68, 74, 78)
- Selecting the FUNC. menu item (p. 48)
- Moving the Face Detect function's face frame (p. 96)
- Adjusting the exposure (p. 101)



■ The Playback Functions

- Selecting an image (pp. 18, 118, 119, 122)
- Operating when viewing/editing movies (pp. 26, 129, 131)
- Operating the sound memos or sound recorder (pp. 151, 152)
- Operating DPOF print settings and transfer settings (pp. 165, 172)

■ The Shooting and Playback Functions

- Selecting a menu item (pp. 48, 49)
- Selecting a time zone (p. 175)
- Changing the clock display color (p. 47)
- Registering My Camera contents (p. 188)

Using the Button

The  button can turn the camera on/off and switch between the shooting/playback modes. In addition, you can register slideshow or sound recorder functions to the  button ([p. 163](#)).

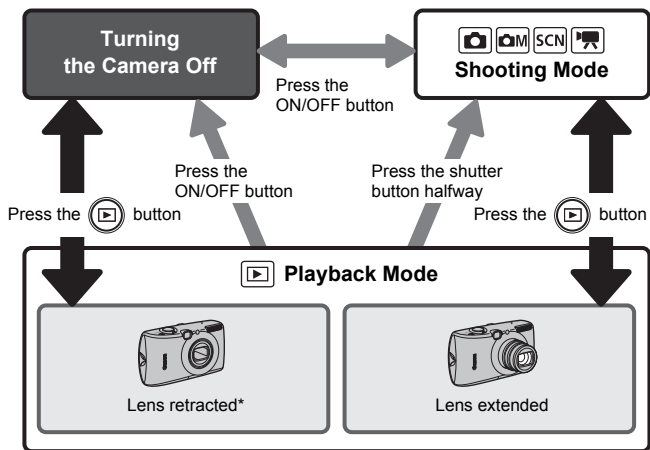
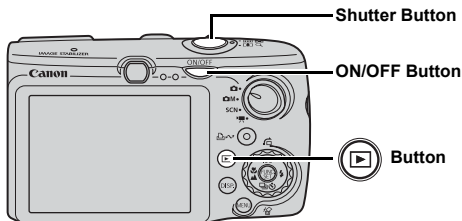

• May operate differently than above when functions are registered to the  button ([p. 163](#)).

* The amount of time before the lens automatically retracts can be set in [Lens Retract] in the  (Set up) menu ([p. 58](#)).

How to Use the Mode Dial

Turn the mode dial to the mode you wish to use.

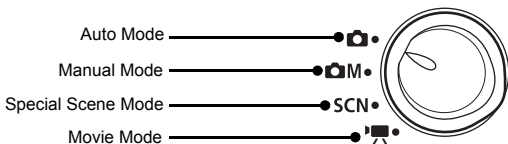

: Auto Mode (p. 16)

Manual Mode

: Manual (p. 78)

: Digital Macro (p. 66)

: Color Accent (p. 109)

: Color Swap (p. 111)

: Stitch Assist (p. 88)

SCN Special Scene Mode

: Portrait (p. 75)

: Night Snapshot (p. 75)

: Kids&Pets (p. 76)

: Indoor (p. 76)

: Sunset (p. 76)

: Foliage (p. 76)

: Snow (p. 76)

: Beach (p. 76)

: Fireworks (p. 77)

: Aquarium (p. 77)

: ISO 3200 (p. 77)

Movie Mode (pp. 24, 82)

: Standard

: Compact

: Color Accent

: Color Swap

: Time Lapse

Indicators

The camera indicators will light or blink under the following conditions.

• Left Side Indicator

- Green : Ready to shoot (camera beeps twice)/when display off
- Blinking Green : Time Lapse (movie) recording/Image recording/reading/erasing/transferring (when connected to a computer or printer)
- Orange : Ready to shoot (flash on)
- Blinking Orange : Ready to shoot (camera shake warning)

• Right Side Indicator

- Yellow: Macro mode/Infinity mode/AF lock mode
- Blinking Yellow: Focusing difficulty (camera beeps once)



Never do the following while the indicator blinks green. These actions may corrupt image data.

- Shake or jolt the camera.
- Shut off the power, or open the memory card slot/battery cover.

Using the Clock

You can display the current date and time for a 5-second* interval using the following two methods.

* Default setting

A digital display showing the date '15 08' and the time '14'. The numbers are arranged in a grid: '1' and '5' in the first row, '0' and '8' in the second row, and '1' and '4' in the third row. There is a small square icon between '08' and '14'.

- ① Hold the **FUNC./SET** button down while turning on the power.
- ② In a shooting/playback mode, press the **FUNC./SET** button for more than one second.

If you hold the camera horizontally, it displays the time. If you hold it vertically, the time and date display. However, if you hold the camera vertically and use method ① to display the date and time, the time will be initially displayed in the same way as when the camera is held horizontally.

- You can change the display color by pressing the ◀ or ▶ button, or using the control dial.
- The clock display will disappear when the display interval is over or when a button is operated for a subsequent operation.
- The clock's display interval can be changed in the  menu (p. 58).
- The clock cannot be displayed when images are magnified or it is in the index playback mode.

Basic Operations

Menus and Settings

Settings for the shooting or playback modes or such camera settings as the print settings, date/time and sounds are set using the FUNC. menu or the Rec., Play, Print, Set up or My Camera menu.

FUNC. Menu (**Button**)

This menu sets many of the common shooting functions.

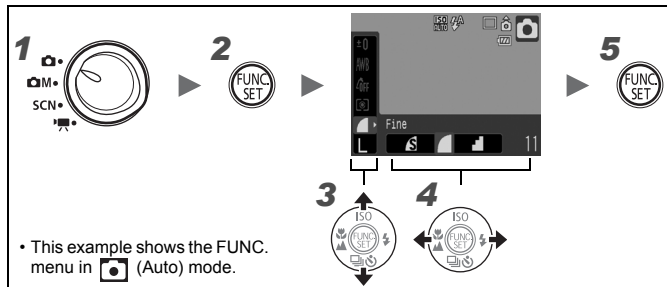

1 Set the mode dial to , ,  or .

2 Press the  button.

3 Use the  or  button to select a menu item.
Some items may not be selectable in some shooting modes.

4 Use the  or  button to select an option for the menu item.

- Items showing the  icon can be changed with the **DISP.** button.
- After selecting an option, you can press the shutter button to shoot immediately. After shooting, the menu will appear again, allowing you to adjust the settings easily.
- You can also use the control dial to select an option for the menu item.

5 Press the  button.

Rec., Play, Print, Set up and My Camera Menus (MENU Button)

Convenient settings for shooting, playback or printing can be set with these menus.

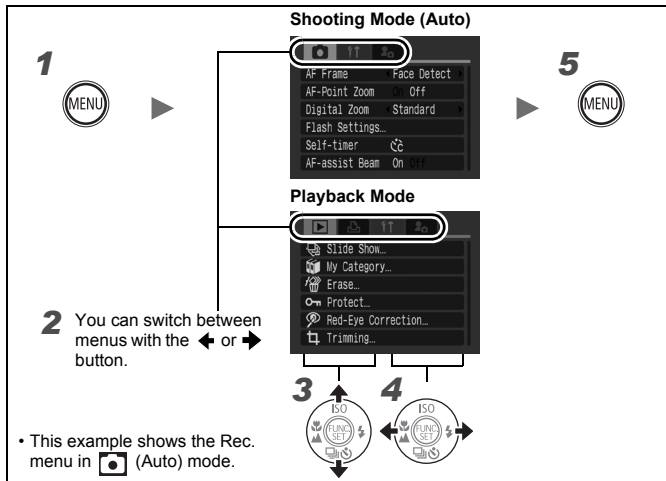







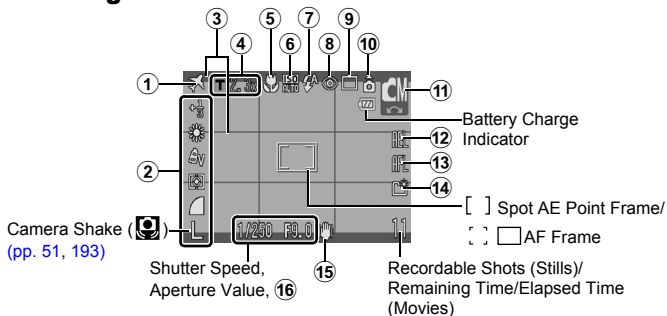

- 1** Press the **MENU** button.
- 2** Use the **←** or **→** button to switch between menus.
 - You can also use the zoom lever to switch between menus.
- 3** Use the **↑** or **↓** button to select a menu item.
 - Some items may not be selectable in some shooting modes.
 - You can also use the control dial to select a menu item.
- 4** Use the **←** or **→** button to select an option.
 - Menu items followed by an ellipsis (...) can only be set after pressing the **FUNC./SET** button to display the next menu. Press the **FUNC./SET** button again to confirm the setting and press the **MENU** button to return the menu screen.
- 5** Press the **MENU** button.

Information Displayed on the LCD Monitor and Menus

Shooting Mode





	Information Displayed	Setting Method
①	Time Zone (Home/World)	MENU button (Set up menu)
②	Exposure Compensation (-2...+2) or Recording Pixels, etc.	FUNC./SET button
③	Display Overlays	MENU button (Rec. menu)
④	Digital Zoom Factor/ Digital Tele-Converter (T 1.4x/2.3x)	MENU button (Rec. menu)
⑤	Macro (M)/Infinity (∞)	M / ∞ button
⑥	ISO Speed (ISO AUTO HI 80 100 200 400 800 1600 3200)	ISO button (ISO 3200 selected in SCN mode)
⑦	Flash (A, lightning bolt, off)	lightning bolt button
⑧	Red-Eye Corr. (eye icon)	MENU button ([Flash Settings] menu in the Rec. menu)
⑨	Drive Mode (square, circle, etc. icons)	drive mode button
⑩	Auto Rotate (camera icons)	MENU button (Set up menu)
⑪	Shooting Mode	Mode dial, Control dial
⑫	AE Lock (AEL)/FE Lock (FEL)	ISO button

	Information Displayed	Setting Method
13	AF Lock (AFL) 	 button
14	Create Folder ()	MENU button (Set up menu)
15	Camera Shake (   )	MENU button (Rec. menu)
16	Exposure Shift Bar (Movies) 	ISO button

About the Battery Charge Indicator

• The following icon and message will display.

Icons/message	Summary
	Sufficient battery charge.
	Recharge the battery soon for extended use.
 (blinking red)	Low battery charge. Recharge the battery.
Change the battery	Battery is depleted and the camera can no longer operate. Charge the battery immediately.



If the indicator blinks orange and the camera shake warning icon () displays, this indicates that a slow shutter speed may have been selected due to insufficient illumination. Use the following methods to shoot:

- Set the IS mode to any setting other than [Off] (p. 72)
- Raise the ISO speed (p. 74)
- Select a setting other than  (flash off) (p. 66)
- Attach the camera to a tripod or other device

Playback Mode (Detailed)

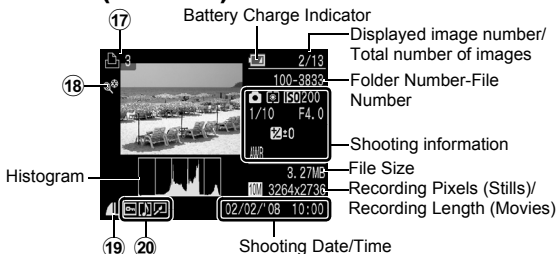

	Information Displayed	Setting Method
17	Print List	button, MENU button (Print menu)
18	Auto Category/My Category ()	MENU button (Rec. menu/Play menu)
19	Compression (Still Images)/Recording Pixels (Still Images), Movie ()	FUNC./SET button (FUNC. menu)
20	Red-Eye Correction Function/ Resized image/Trimmed image/ My Colors (Playback) ()	MENU button (Play menu)
	Image with Sound Memo ()	
	Protection Status ()	

The following information may also be displayed with some images.

	A file in a format other than the WAVE format is attached.
	JPEG image not conforming to Design rule for Camera File System Standards.
	RAW image
	Unrecognized data type



- Information for images shot on other cameras may not display correctly.
- Overexposure Warning
In the following cases, overexposed portions of the image blink.
 - When reviewing an image right after shooting in the LCD monitor (detailed display)
 - When using the detailed display mode of the playback mode

Histogram Function

The histogram is a graph that allows you to check the brightness of an image. The greater the bias toward the left in the graph, the darker the image. The greater the bias toward the right, the brighter the image. By using the exposure compensation function, you can correct the image brightness before shooting (p. 101).

Sample Histograms



Dark Image



Balanced Image

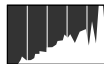

Bright Image

Shooting Mode

Menu Item		Reference Page
Auto Mode		p. 16
Manual Mode		pp. 66, 78, 88, 109, 111
Special Scene Mode		p. 75
Movie Mode		pp. 24, 82











FUNC. Menu

Menu Item		Reference Page
Exposure Compensation		p. 101
Long Shutter Mode		p. 103
White Balance		p. 104
My Colors		p. 107
Metering Mode		p. 102
Compression		p. 71
Shooting Interval (Movie)		p. 87
Recording Pixels (Still Image)	 	p. 70
Recording Pixels (Movie)		p. 86

Rec. Menu

* Default setting

Menu Item	Options	Summary/ Reference Page
AF Frame	Face Detect*/AiAF/Center	p. 93
AF Frame Size	On*/Off	p. 95
AF-Point Zoom	On/Off*	p. 90
Digital Zoom		p. 62
(Still Image)	Standard*/Off/1.4x/2.3x	
(Movies)	Standard*/Off (In standard movie mode only)	
Flash Settings		p. 80
Slow Synchro	On/Off*	
Red-Eye Corr.	On/Off*	
Red-Eye Lamp	On*/Off	

Menu Item	Options	Summary/ Reference Page
Self-timer	Delay: 0 – 10*, 15, 20, 30 sec. Shots: 1 – 10 (Default setting is 3 shots.)	p. 68
AF-assist Beam	On*/Off	p. 40
Review	Off/ 2* sec. to 10 sec./Hold	You can set the length of time images display after being shot (p. 17).
Review Info	Off*/Detailed/Focus Check	p. 96
Save Original	On/Off*	p. 113
Auto Category	On*/Off	p. 115
Disp. Overlay		
(Still image)	Off*/Grid Lines/3:2 Guide/ Both	p. 114
(Movie)	Off*/Grid Lines	
IS Mode		
(Still image)	Continuous*/Shoot Only/ Panning/Off	p. 72
(Movie)	Continuous*/Off	
Set  button	 */  /  /WB/  /  /  /  /  /  / 	p. 116

Play Menu

Menu Item	Reference Page
Slide Show	p. 136
My Category	p. 124
Erase	p. 158
Protect	p. 154
Red-Eye Correction	p. 142
Trimming	p. 127
Resize	p. 149
My Colors	p. 147

Menu Item	Reference Page
Sound Memo	p. 151
Sound Recorder	p. 152
Rotate	p. 134
Transfer Order	p. 172
Set Play button	p. 163
Resume	p. 18
Transition	p. 135

Print Menu



Menu Item	Summary	Reference Page
Print	Displays the print menu.	–
Select Image & Qty.	Configures print settings for individual images as you view them.	p. 165
Select Range	Selects a range of sequential images and makes print settings for all the images in that range.	
Select by Date	Configures print settings for images corresponding to the selected date.	
Select by Category	Configures print settings for images in the selected category.	
Select by Folder	Configures print settings for images in the selected folder.	
Select All Images	Configures print settings for all images.	
Clear All Selections	Removes all print settings from images.	
Print Settings	Sets the print style.	

Set up Menu





Menu Item	Options	Summary/Reference Page
Mute	On/Off*	Set to [On] to silence all operation sounds*. * Except for when the memory card slot/ battery cover is opened during recording.
Volume	Off/ 1 / 2*/ 3 / 4 / 5	Adjusts the volume of the start-up sound, operation sound, selftimer sound, shutter sound and playback sound. The volume cannot be adjusted if [Mute] is set to [On].
Start-up Vol.		Adjusts the volume of the start-up sound when the camera is turned on.
Operation Vol.		Adjusts the volume of the operation sound that beeps when any button other than the shutter button is pressed.
Selftimer Vol.		Adjusts the volume of the selftimer sound played 2 sec. before the shutter is released.
Shutter Volume		Adjusts the volume of the sound played when the shutter releases. The shutter sound does not play when a movie is recording.
Playback Vol.		Adjusts the volume of movie sounds or sound memos.
LCD Brightness	-7 to 0* to +7	Use the ◀ or ▶ button to adjust the brightness. You can check the brightness in the LCD monitor while you are adjusting the setting.
Power Saving		p. 174
Auto Power Down	On*/Off	
Display Off	10 sec./20 sec./30 sec./1 min.* / 2 min. / 3 min.	

Menu Item	Options	Summary/Reference Page
Time Zone	Home*/World	p. 175
Date/Time		p. 14
Clock Display	0 – 5* – 10 sec./ 20 sec./30 sec./ 1 min./2 min./3 min.	
Format		You can also select a low level format (p. 178).
File Numbering	Continuous*/ Auto Reset	p. 179
Create Folder		
Create New Folder	Check mark (On)/ No check mark (Off)	p. 181
Auto Create	Off*/Daily/Monday- Sunday/Monthly (Creation time also can be set)	
Auto Rotate	On*/Off	p. 183
Lens Retract	1 minute*/0 seconds	Sets the lens retraction timing when switching from shooting mode to playback mode (p. 44).
Language		p. 15
Video System	NTSC/PAL	p. 186
Print Method	Auto*/ 	See below.
Reset All		p. 184

Print Method

The connection method with the printer can be changed for printing. Although it is normally not necessary to change the setting, select  when borderless printing an image shot in  (Widescreen) mode on wide size paper using Canon compact photo printer SELPHY CP750/CP740/CP730/CP720/CP710/CP510/CP520. As this setting will be stored to memory even when the power is turned off, to print using an image size other than , return the mode to [Auto] (however, the connection method cannot be changed while connected to a printer).

My Camera Menu

Menu Item	Summary	Reference Page
Theme	Selects a common theme for each My Camera settings item.	p. 188
Start-up Image	Sets the image displayed when the camera power is turned on.	
Start-up Sound	Sets the sound played when the camera power is turned on.	
Operation Sound	Sets the sound played when any button other than the shutter button is pressed.	
Selftimer Sound	Sets the sound played 2 seconds before the shutter releases in self-timer mode.	
Shutter Sound	Sets the sound played when the shutter button is pressed. (There is no shutter sound for movies.)	
My Camera Menu Contents	 (Off) /  * /  / 	

Using the LCD Monitor

Switching LCD Monitor Display Modes

Each press of the **DISP.** button, changes the display mode of the LCD monitor. See *Information Displayed on the LCD Monitor and Menus* for details (p. 50).

(The following are the screens that display when shooting in  (Auto) mode.)

■ Shooting Mode

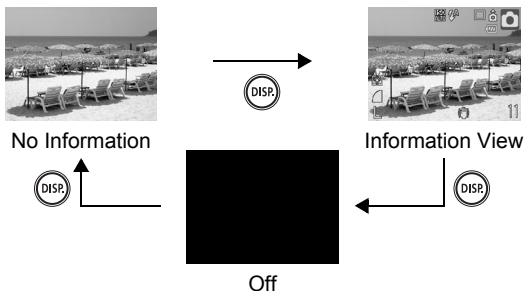

■ Playback Mode or Rec. Review (Right After Shooting)

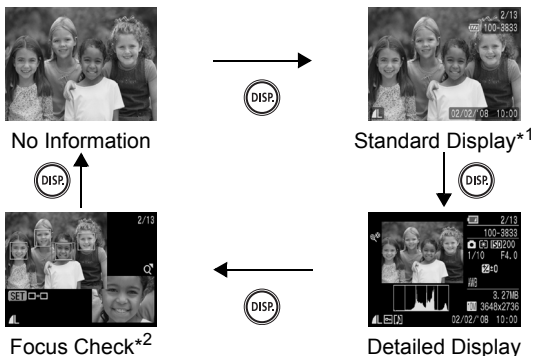

*1 Playback mode only

*2 Still image only



- The LCD monitor on or off setting is retained even after the camera power is turned off.
- The LCD monitor does not shut off in the , , , , or Movie mode.
- The LCD monitor is set to the Information View in the , , , or mode.
- The LCD monitor will not switch to the detailed display or focus check display in magnified display (p. 118), or index playback mode (p. 119).

LCD Monitor Brightness Settings

The brightness of the LCD monitor can be changed in the following two ways.

- **Changing settings using the Set up menu (p. 57)**
- **Changing settings using the DISP. button (Quick-bright LCD Function)**

You can set the LCD monitor to the brightest setting regardless of the option selected in the Set up menu by pressing the **DISP.** button for more than one second*.

- To restore the previous brightness setting, press the **DISP.** button for more than one second again.
- The next time you turn on the camera, the LCD monitor will be at the brightness setting selected in the Set up menu.

* You cannot change the brightness of the LCD monitor with this function if you have already set it to its highest setting in the Set up menu.

Night Display

When shooting at dusk or during the evening when the dark surroundings make it difficult to view the LCD monitor, the camera's "night view" option* displays the subject brightly in the LCD monitor. This will allow you to compose a shot even in dark environments (this setting cannot be turned off).

* Although noise may appear and the movement of the subject shown on the LCD monitor may appear somewhat jagged, there is no effect on the recorded image. The brightness of the image displayed in the monitor, and the brightness of the actual image recorded will be different.

Commonly Used Shooting Functions

You can also use the control dial to select shooting modes or FUNC. menu options. See [p. 43](#).



Using the Optical Zoom



The zoom can be adjusted from 37 – 185 mm (focal length) in 35mm film equivalent terms.

1 Press the zoom lever toward

 or .

-  Wide Angle: Zooms out from the subject.
-  Telephoto: Zooms in on the subject.

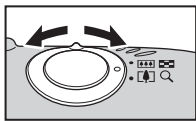

Using the Digital Zoom/ Digital Tele-Converter





Available Shooting Modes >> [p. 232](#)

You can combine digital zoom with optical zoom when shooting. The available shooting characteristics and focal lengths (35mm film equivalent) are as follows.

Selection	Focal Length	Shooting Characteristics
Standard	37 – 740 mm	Enables shooting at zoom factors of up to 20x with digital and optical zoom combined.
Off	37 – 185 mm	Enables shooting without digital zoom.
1.4x	51.8 – 259 mm	Digital zoom is fixed at the selected zoom factor, and the focal length shifts to maximum telephoto.
2.3x	85.1 – 425.5 mm	This enables a faster shutter speed and less chance of camera shake than a shot taken at the same angle of view with [Standard] or [Off].

About the Safety Zoom



Depending on the number of recording pixels set, you can shift from optical zoom to digital zoom without pausing up to a factor where the image quality does not deteriorate (Safety Zoom).  displays when reaching the maximum zoom factor without image deterioration.

Pressing the zoom lever toward  again allows you to zoom even further (not available in ).



Depending on the number of recording pixels set, the Safety Zoom zone varies as follows.

Safety Zoom Factor

Recording pixels	Optical zoom	Digital zoom
L	5.0x	
M1	5.0x	
M2	7.0x	
M3		11x
S		20x

 : Zone without deterioration  : Zone with deterioration



- The digital zoom cannot be used when the LCD monitor is turned off.
- The digital zoom cannot be used in  (Date Stamp) or  (Widescreen) modes.



Shooting with the Digital Zoom

1 Select [Digital Zoom].

1. Press the  button.
2. In the  menu, use the  or  button to select [Digital Zoom].



2 Make settings.

1. Use the  or  button to select [Standard].
2. Press the  button.



3 Press the zoom lever toward and shoot.

- The combined digital and optical zoom factor will display in the LCD monitor.
- The image may appear coarse depending upon the selected recording pixels. The zoom factor appears in blue.
- Press the zoom lever toward  to zoom out.

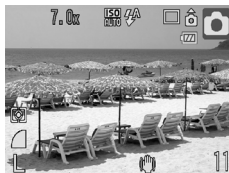

Shooting with the Digital Tele-Converter



The digital tele-converter feature uses digital zoom to achieve the effects of a tele-converter (a lens used in telephoto shooting).

1 Select [Digital Zoom].

1. Press the  button.
2. In the  menu, use the  or  button to select [Digital Zoom].



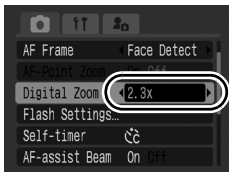

2 Make settings.

1. Use the  or  button to select [1.4x] or [2.3x].
2. Press the  button.



3 Adjust the angle of view with the zoom lever and shoot.

-  and the zoom factor appear on the LCD monitor.
- The image may appear coarse depending upon the selected recording pixels (the  icon and the zoom factor appear in blue).



Magnified Close-Up Shooting (Digital Macro)



Available Shooting Modes >> p. 232

You can shoot a subject 2 – 10 cm (0.79 – 3.9 in.) from the end of the lens at the maximum wide angle setting. With the digital zoom, the image area is 7 × 5 mm (0.28 × 0.20 in.) at maximum zoom (approximately 4.0x).

1 Select Digital Macro.

1. Set the mode dial to M.
2. Use the control dial to select D.



2 Choose the angle of view with the zoom lever and shoot.

- The zoom factor appears on the LCD monitor.

⚡ Using the Flash



Available Shooting Modes >> p. 232

1 Press the ⚡ button.

1. Use the or button to select the flash settings.

: [Auto]

: [On]

: [Off]



- You can configure detailed settings for the flash (Slow Synchro, Red-Eye Corr. and Red-Eye Lamp) when you press the **MENU** button while this screen is displayed (p. 80).



You are recommended to shoot with the camera attached to a tripod or other device if the camera shake warning icon () appears.



Shooting Close-Ups/Infinity







Available Shooting Modes >> p. 232

You can shoot close-ups or infinity shots.

	Macro	Use this mode to shoot close-ups of flowers or small items. Area at Minimum Focusing Distance from End of Lens to Subject Maximum wide angle setting: 30 × 22 mm (1.2 × 0.87 in.) (Minimum focusing distance: 2 cm (0.79 in.))
	Infinity	Use this mode to record subjects 3 m (9.8 ft.) or more from the end of the lens.





1

Press the button.

- Use the  or  button to select  or .



To Cancel the Macro Mode:

Press the  button and use the  or  button to select  (Normal).





- Use the LCD monitor to compose close-ups in macro mode since the view through the viewfinder may not match the image taken.
- Using the flash in macro mode may cause image edges to darken.

🕒 Using the Self-Timer



Available Shooting Modes >> [p. 232](#)

You can set the time delay and the numbers of shots you wish to take in advance.

	<p>10 sec. Self-Timer: The shutter releases 10 seconds after the shutter button is pressed.</p> <ul style="list-style-type: none"> • 2 seconds before the shutter releases, the self-timer sound beeps quickly* and the lamp will speed up.
	<p>2 sec. Self-Timer: The shutter releases 2 seconds after the shutter button is pressed.</p> <ul style="list-style-type: none"> • The self-timer sound beeps quickly* and the self-timer lamp blinks when the shutter button is pressed and the shutter releases 2 seconds later.
	<p>Custom Timer: You can change the delay time (0 – 10, 15, 20, 30 sec.) and number of shots (1 – 10).</p> <ul style="list-style-type: none"> • When a delay time of over 2 seconds is set for the [Delay] option, the self-timer sound beeps* quickly 2 seconds before the shutter releases. If multiple shots have been specified for the [Shots] option, the sound will play for the first shot only.

* This may differ depending on your My Camera settings ([p. 188](#)).

1 Press the 🕒 button.

1. Use the **↑** or **↓** button to change the self-timer mode.
- Pressing the **MENU** button while this screen is displayed will allow you to set the delay and number of shots as when Custom Timer is selected ([p. 69](#)).



2 Shoot.

- When you press the shutter button fully, the self-timer lamp will blink.*

* When [Red-Eye Lamp] is set to [On] in [Flash Settings] in the Rec. menu, the self-timer lamp will light 2 seconds before the flash fires (p. 80).

To Cancel the Self-Timer:

Press the  button and the  or  button to select .







Changing the Delay Time and Number of Shots (🕒)

1 Select [Self-timer].

1. Press the  button.
2. In the  menu, use the  or  button to select [Self-timer].
3. Press the  button.



2 Make settings.

1. Use the  or  button to select [Delay] or [Shots] and the  or  button to change the settings.
2. Press the  button.
3. Press the  button.

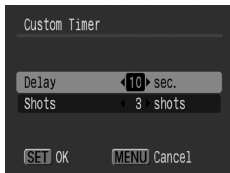

If the [Shots] option is set to 2 or more shots, the following occurs.

- The exposure and white balance are locked at the settings selected for the first shot.
- If the flash is used, the interval between shots lengthens.
- The interval between shots may lengthen when the built-in memory of the camera fills.
- Shooting will automatically cease if the memory card becomes full.

Changing the Recording Pixels (Still Images)



Available Shooting Modes >> p. 232

1 Select the recording pixels.

1. Press the button.
2. Use the or button to select **L** and the or button to change the recording pixels.
3. Press the button.

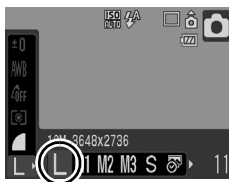

Approximate Values for Recording Pixels

Recording Pixels				Purpose*
L Large	10M	3648 × 2736	High Low	Printing to about A2-size 420 × 594 mm (16.5 × 23.4 in.)
M1 Medium 1	6M	2816 × 2112		Printing to about A3-size 297 × 420 mm (11.7 × 16.5 in.)
M2 Medium 2	4M	2272 × 1704		Printing to about A4-size 210 × 297 mm (8.3 × 11.7 in.) Printing to about Letter-size 216 × 279 mm (8.5 × 11 in.)
M3 Medium 3	2M	1600 × 1200		Printing postcard-size prints 148 × 100 mm (6 × 4 in.) Printing L-size prints 119 × 89 mm (4.7 × 3.5 in.)
S Small	0.3M	640 × 480		Sending images as e-mail attachments or shoot more images.
Date Stamp	2M	1600 × 1200		Printing date-stamped images (p. 22), in L-size or postcard-size (you can check the print area at a 3:2 aspect ratio as you shoot).
Widescreen		3648 × 2048		Printing on wide size paper (you can check the composition at a 16:9 aspect ratio. Areas that will not be recorded appear on the LCD monitor as a black border.)

: Approximate recording pixel numbers are shown. (M is short for megapixels.)

* Paper sizes vary according to region.









- See *Memory Cards and Estimated Capacities* (p. 223)
- See *Image Data Sizes (Estimated)* (p. 225)

Changing the Compression (Still Images)







Available Shooting Modes >> p. 232

1 Select a compression setting.

1. Press the  button.
2. Use the  or  button to select  and the  or  button to change the option.
3. Press the  button.



Approximate Values for Compression Settings

Compression		Purpose
 Superfine	High Quality	Shoot higher quality images.
 Fine	 Normal	Shoot normal quality images.
 Normal		Shoot more images.



- See *Memory Cards and Estimated Capacities* (p. 223)
- See *Image Data Sizes (Estimated)* (p. 225)

Setting the Image Stabilizer Function



Available Shooting Modes >> p. 232

The lens-shift type image stabilizer function allows you to minimize the camera shake effect (blurred images) when you shoot distant subjects that have been magnified or when you shoot in dark conditions without a flash.

	Off	–
	Continuous	You can check the effect of the IS mode on image blur on the LCD monitor since the IS mode runs continually. This makes it easier to compose images and focus on subjects.
	Shoot Only	Shoot Only IS mode is only activated when the shutter button is pressed. When set to [Continuous], some blurring may occur depending on the subjects. In Shoot Only mode, subjects can be taken without concern for any unnatural movement that may appear on the LCD monitor.
	Panning	This option only stabilizes the effect of up and down camera motions on the image. This option is recommended for shooting objects moving horizontally.

1 Select [IS Mode].

1. Press the button.
2. In the menu, use the or button to select [IS Mode].

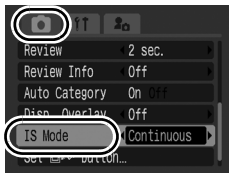

2 Make settings.

1. Use the or button to select the image stabilizer settings.
2. Press the button.

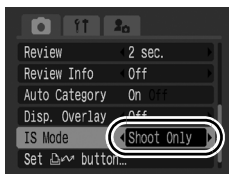



- Camera shake may not be fully corrected when shooting with slow shutter speeds, such as with evening shots. Use of a tripod is recommended.
- If camera shake is too strong, it may not be fully corrected.
- Hold the camera horizontally while [Panning] (stabilization does not work when the camera is held vertically).
- If you shoot a movie after setting [IS Mode] to [Shoot Only] or [Panning], the setting will change to [Continuous].

ISO Adjusting the ISO Speed



Available Shooting Modes >> p. 232

Raise the ISO speed to use a fast shutter speed when you wish to reduce the effects of camera shake or avoid blurry subjects, or to turn the flash off when shooting in a dark area.

1 Press the **ISO** button.

1. Use the **↑** or **↓** button to change the ISO speed.

- You can advance to the next option each time you press the **ISO** button.
- When you select **ISO AUTO** (Auto) or **ISO HI** (High ISO Auto), the camera sets the optimal ISO speed for the light level when shooting. As the ISO speed will automatically be raised in dark places, shutter speed will increase, reducing camera shake and subject blurring.
- Select **ISO AUTO** to put priority on image quality.
- When you select **ISO HI**, the camera also detects motion and sets the optimum ISO speed. As the shutter speed becomes even faster*, camera shake and blurred photos caused by subject movement will be reduced even more than when shooting the same scene in **ISO AUTO**.

* Noise may increase in the captured image compared to **ISO AUTO**.



- You can set the ISO speed to **ISO 3200** (p. 74).
- The camera automatically applies noise reduction processing when you shoot at a high ISO speed.
- If the camera is set at **ISO AUTO** or **ISO HI**, the ISO speed automatically set by the camera will be displayed when pressing the shutter button halfway or in playback information.



Kids&Pets

Allows you to capture subjects that move around, such as children and pets, without missing photo opportunities.



Indoor

Prevents camera shake and maintains the subject's true color when shooting under fluorescent or tungsten lighting.



Sunset

Allows you to shoot sunsets in vivid colors.

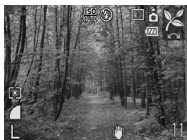

Foliage

Shoots trees and leaves - such as new growth, autumn leaves or blossoms - in vivid colors.

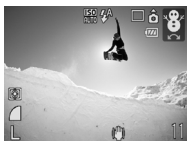

Snow

Shoots without a blue tinge and without making people appear dark against a snowy background.



Beach

Shoots without making people appear dark near water or sand where reflected sunlight is strong.



Fireworks

Captures fireworks in the sky sharply and at optimal exposure.



Aquarium

Selects the optimal ISO speed, white balance and color balance to capture fish and other items in an indoor aquarium.

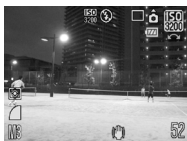







ISO 3200

Shoots with the ISO speed set to 3200, twice as fast as ISO 1600. Use when a high ISO speed is required. Avoids blurring of the subject and the effects of camera shake.

Recording pixels are fixed at  (1600 × 1200).



- The shutter speed is slow in  mode. Always use a tripod to avoid camera shake.
- In , ,  or  mode, the ISO speed may increase and cause noise in the image depending on the scene being shot.
- With , image noise may be prominent.

Shooting in Manual Mode



Available Shooting Modes >> p. 232

Allows you to select settings yourself, such as the exposure compensation, white balance or My Colors.

1 Select manual mode.

1. Set the mode dial to .
2. Use the control dial to select .



Continuous Shooting



Available Shooting Modes >> p. 232

In this mode, the camera shoots continuously while the shutter button is held down.

If you use the recommended memory card*, you can shoot continuously (smooth continuous shooting) at a set shooting interval until the memory card is full (p. 223).

*Recommended Memory Card:

Super high-speed SDC-512MSH memory card (sold separately) to which low-level formatting (p. 178) is conducted immediately before shooting.

- This reflects standard shooting criteria established by Canon. Actual results may vary according to the subject and shooting conditions.
- Even if continuous shooting suddenly stops, the memory card may not be full.

1 Press the button.

1. Use the  or  button to select

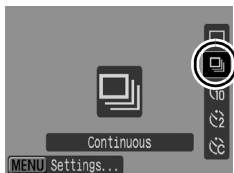

2 Shoot.

- The camera will continue to record successive images while the shutter button is held down. Recording will cease when the shutter button is released.

To Cancel Continuous Shooting:

Follow Step 1 to select .



- The interval between shots lengthens when the built-in memory of the camera fills.
- If the flash is used, the interval between shots lengthens because the flash must charge.

Setting the Flash



Available Shooting Modes >> p. 232

You can make detailed flash settings to fit the shooting conditions.

Flash Settings

Slow Synchro	The flash timing is adjusted to slow shutter speeds. This reduces the chance that only the background will appear dark when a night scene or an interior shot is taken. Using Slow Synchro increases the chances for camera shake. Use of a tripod is recommended.
Red-Eye Corr.	Automatically searches for and corrects red eyes in the image when the flash fires.
Red-Eye Lamp	This feature reduces the effect of light reflecting back from the eyes and making them appear red. When set to [On], the red-eye reduction lamp lights orange before the flash fires.



About Red-Eye Correction

- When [Red-Eye Corr.] is set to [On], only the corrected image is recorded to the memory card.
- If the area around the eyes is red, for example from using red eye shadow, that area may also be corrected. If this happens, set [Red-Eye Corr.] to [Off].
- Red eyes may not be automatically detected or may not be fully corrected on some images. In either case, you can correct images with [Red-Eye Correction] in the Play menu (p. 142).

1 Select [Flash Settings].

1. Press the  button.
2. In the  menu, use the  or  button to select [Flash Settings].
3. Press the  button.

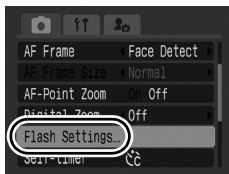

2 Make settings.

1. Use the \uparrow or \downarrow to select the option.
2. Use the \leftarrow or \rightarrow button to make the setting.
3. Press the  button.

- [Flash Settings] can also be displayed by pressing the \downarrow button, followed by the **MENU** button.



3 Press the button.





Movie Shooting



Available Shooting Modes >> p. 232

The following movie modes are available.

The recording time will differ according to the memory card used (p. 224).



	Standard
<p>You can select the recording pixels and record until the memory card is full*¹. The digital zoom can be used while shooting in this mode (p. 62).</p>	
<ul style="list-style-type: none"> • Maximum Size: 4 GB/movie*² 	
	Compact
<p>Since there are few recording pixels and also the data size is small, this mode is convenient for sending movies as e-mail attachments or when the memory card capacity is low.</p>	
<ul style="list-style-type: none"> • Maximum Clip Length: 3 minutes 	
	Color Accent,  Color Swap
<p>You can have only the specified color remain and change all others into black and white, or change a specified color into a different color. (pp. 109, 111). As with the Standard mode, you can select the recording pixels and record until the memory card is full*¹.</p>	
<ul style="list-style-type: none"> • Maximum Size: 4 GB/movie*² 	
	Time Lapse
<p>Select a shooting interval (1 or 2 sec.) to have a single frame shot at that interval. When played back, two hours worth of recorded frames is compressed to 8 minutes (1-sec. interval) or 4 minutes (2-sec. interval). You can record events from a fixed perspective, such as the spectacle of a flower budding over time, or view changing elements in a short period. Sound cannot be recorded in this mode.</p>	
<ul style="list-style-type: none"> • Maximum recording session: 2 hours 	

*1 When a super high-speed memory card is used, such as the recommended SDC-512MSH.

*2 Even if the file size has not reached 4 GB, the recording is stopped when the recording time reaches one hour. Depending on memory card capacity and data write speed, recording may stop before the file size reaches 4 GB or the recording time reaches one hour.

1 Select a movie mode.

1. Set the mode dial to .
2. Use the control dial to select a movie mode.

- See *Changing Colors* (p. 109) for the procedures for using  and .











2 Shoot.

- Pressing the shutter button halfway automatically sets the exposure, focus and white balance settings.
- Pressing the shutter button fully starts recording video and sound simultaneously.
- During shooting, the recording time and [●Rec] appear on the LCD monitor.
- Pressing the shutter button fully again stops recording. Recording will stop automatically under the following circumstances.
 - When the maximum recording time or maximum recording capacity is reached
 - When the built-in memory or memory card becomes full





- You are recommended to use a memory card that has been formatted in your camera to shoot movies (p. 178). The card supplied with the camera may be used without further formatting.
- Be careful of the following while recording.
 - Try not to touch the microphone (p. 42).
 - Do not press any buttons other than the shutter button. The sound that buttons make will be recorded in the movie.
 - The camera will automatically adjust the exposure and white balance to suit the shooting conditions during a recording. Please note, however, that the sounds made by the camera while automatically adjusting the exposure may also be recorded.
- The focus and optical zoom settings remain fixed for subsequent frames at the values selected for the first frame.









- Adjust the zoom setting before shooting. The combined digital and optical zoom factor will display on the LCD monitor. When the zoom factor displays in blue, the image will deteriorate.
- You can use digital zoom during the movie shooting in  mode only.
- Before recording, you can set the AE lock and exposure shift. This is effective on ski slopes and the beach when the contrast is too strong between the subject and background or where there are both light and dark areas in the scene and it is desirable to adjust the exposure.
 - 1 Press the **ISO** button.
The exposure will lock (AE lock) and the exposure shift bar will appear in the LCD monitor.
 - 2 Use the  or  button to adjust the exposure.
Press the **ISO** button again to release the setting. Also, the setting will be canceled if you press the **MENU** button or change the white balance, My Colors or shooting mode settings.
- If you register the  function to the  button, you can start shooting a movie simply by pressing the  button even if the mode dial is set to ,  or **SCN** (p. 163).
- QuickTime is required to play back movies (Data type: AVI/ Compression method: Motion JPEG) on a computer (Windows 2000 only).

Changing Movie Recording Pixels/Frame Rates

You can change the recording pixels and frame rate when the movie mode is set to  (Standard),  (Color Accent) or  (Color Swap). (The frame rate can be set depending on the recording pixels.)





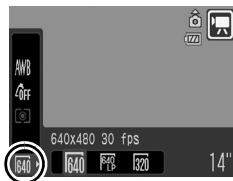





1 Select the recording pixels.

1. Press the  button.
2. Use the  or  button to select  and the  or  button to change the recording pixels.
3. Press the  button.



Movie Recording Pixels and Frame Rates

Frame rates indicate the number of frames recorded or played back each second. The higher the frame rate, the smoother the appearance of motion.

 Standard	 *1	640 × 480 recording pixels, 30 frames/sec.
 Color Accent	 *2	640 × 480 recording pixels, 30 frames/sec. LP
 Color Swap		320 × 240 recording pixels, 30 frames/sec.
 Compact		160 × 120 recording pixels, 15 frames/sec.
 Time Lapse		640 × 480 recording pixels, 15 frames/sec.*3

*1 Default setting.

*2 When priority is on movie length rather than image quality, select . You can shoot for twice as long in this mode compared to a file of the same size shot in the other modes.







*3 Frame rate when playing back.



- See *Memory Cards and Estimated Capacities* (p. 224).
- See *Image Data Sizes (Estimated)* (p. 225)

Changing the Shooting Interval (Time Lapse)

1 Select a shooting interval.

1. Press the  button.
2. Use the  or  button to select  and the  or  to change the option.
3. Press the  button.

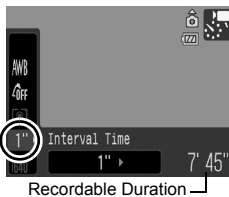

- The indicator will blink green while the camera is recording.



- You are recommended to use a fully charged battery or an AC adapter since the recording period may be lengthy.
- The power saving setting (p. 174) will determine whether or not the LCD monitor shuts off. The LCD monitor will turn on if something other than the ON/OFF button or shutter button is operated.
- The LCD monitor displays the elapsed time from the start of recording to the end in playback mode, but the actual playback time is shorter than the displayed time.

Shooting Panoramic Images (Stitch Assist)



Available Shooting Modes >> p. 232

Stitch Assist can be used to shoot overlapping images that can later be merged (stitched) to create one panoramic image on a computer.



The overlapping seams of several adjacent images can be joined into a single panoramic image.



1 Select the shooting direction.

1. Set the mode dial to M.
2. Use the control dial to select or .

: Left to right horizontally

: Right to left horizontally



2 Shoot the first frame of the sequence.

- The exposure and white balance are set and locked with the first image.



3 **Compose the second image so that it overlaps a portion of the first and shoot.**

- You can press the ◀ or ▶ button to return to the previously recorded image to retake the shot.
- Minor discrepancies in the overlapping portions can be corrected when the images are stitched together.

4 **Repeat the procedure for additional images.**

- A sequence may contain up to 26 images.

5 **Press the button after the last shot.**



- You cannot display the images on a TV when shooting in Stitch Assist mode.
- The settings for the first image are applied to the second image onward.



Use PhotoStitch, a supplied software program, to merge the images on a computer.

Checking the Focus and Peoples' Expressions



Available Shooting Modes >> p. 232

You can zoom the display of the AF frame to check focus when shooting or right after taking a shot.

Zooming the AF Frame and Shooting

When [AF Frame] is set to [Face Detect] or [Center], the AF frame area can be zoomed to check focus while shooting. When you want to capture people's expressions, set [AF Frame] to [Face Detect]. When you want to check the focus while shooting in macro mode, set [AF Frame] to [Center].

1 Select [AF-Point Zoom].

1. Press the button.
2. In the menu, use the or button to select [AF-Point Zoom].

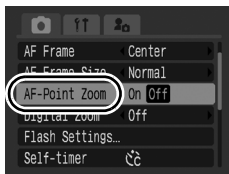

2 Make settings.

1. Use the or button to select [On].
2. Press the button.

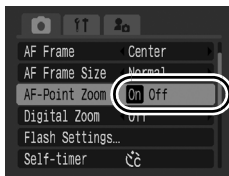

3 Press the shutter button halfway.

- Pressing the shutter button halfway zooms a section of the display according to the following AF Frame mode settings (p. 93).
 - [Face Detect] : The face detected as the main subject will appear zoomed.
 - [Center] : The center of the image will appear zoomed in the LCD monitor.

4 Press the shutter button fully to shoot.



The AF frame cannot be zoomed under the following circumstances:

- When [AF Frame] is set to [Face Detect] and a face is not detected, or when the face is extremely large in relation to the overall composition.
- When the camera cannot focus.
- When the digital zoom is in use.
- When the LCD monitor is off.
- When a TV is being used as the display.

Checking Focus Right After Shooting (Focus Check)

Allows you to check the focus of an image taken. It is also easy to check peoples' expressions and look for closed eyes when shooting because a frame the size of the face displays when AF frame mode is set to [Face Detect] (p. 93).

You are recommended to set [Review] to [Hold] in the  menu in advance.

1 Select [Review Info].

1. Press the  button.
2. In the  menu, use the  or  button to select [Review Info].



2 Make settings.

1. Use the ◀ or ▶ button to select [Focus Check].
2. Press the  button.



3 Shoot.

- The recorded image will be displayed.

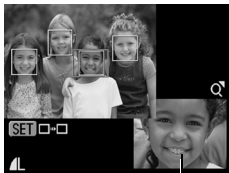

- Frames are displayed as follows.

Orange frame contents



Frame color	Content
Orange	Displays the area of the image shown at the bottom right.
White	Displays at the focal point (AF frame).

- The orange frame can be shown at a different magnification, moved or switched to a different frame (p. 120).

To Cancel the Focus Check:

Press the shutter button halfway.



- Pressing the  button while the image is displayed will erase the image (p. 19). However, when the bottom right of the image is enlarged, pressing the  button will not delete the image.
- You can check the focus even during playback mode (p. 120).

Selecting an AF Frame Mode



Available Shooting Modes >> p. 232

The AF frame indicates the area of the composition on which the camera focuses.

	Face Detect	<p>The camera detects a face and sets the focus, exposure*¹ and white balance*². In addition, the camera meters the subject so that the face is correctly illuminated when the flash fires. If no face is detected, the camera shoots using [AiAF].</p> <p>*1 Only in evaluative metering mode (p. 102). *2 Only in AWB (p. 104)</p>
	AiAF	<p>The camera automatically selects between 9 AF frames to focus on according to the shooting conditions.</p>
	Center	<p>The AF frame will be fixed to center. This is recommended when the target subject is at the center of the composition. You can change the AF frame size (p. 95).</p>

1 Select [AF Frame].

1. Press the button.
2. In the menu, use the or button to select [AF Frame].

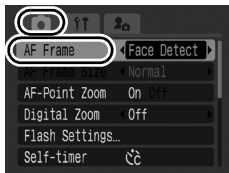

2 Make settings.

1. Use the or button to select an AF frame option.
 2. Press the button.
- See *Changing the AF Frame Size* (p. 95).

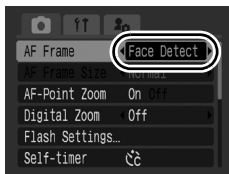



- [Face Detect] cannot be used when the LCD monitor is turned off.
- The AF frame appears as follows when the shutter button is pressed halfway.
 - Green : In focus
 - Yellow : Focusing difficulty ([Center] option)
 - No AF frame : Focusing difficulty ([Face Detect] or [AiAF] option)

Face Detect Feature

- Maximum of three AF frames will be displayed at the positions of faces the camera recognizes. At this point, the frame the camera judges to be the main subject appears in white while the others appear in gray. When the shutter button is pressed halfway and the camera focuses, up to 9 green AF frames may appear.
- The camera will shoot using [AiAF] not the [Face Detect] function if a white frame fails to appear and only gray frames display, or if a face is not detected.
- The camera may mistakenly identify non-human subjects as a face.
- In certain cases, faces may not be detected.

Examples:

- If faces are at the edge of the screen, or appear extremely small, large, dark or bright, relative to the overall composition.
- Faces turned to the side or at a diagonal, or faces with a portion hidden.

Changing the AF Frame Size



When the [AF Frame] is set to [Center], the AF frame can be resized to correspond to the subject. Select [Small] to constrict the focal frame to suit a small subject or to focus on a particular area of a subject.

1 Select [AF Frame Size].

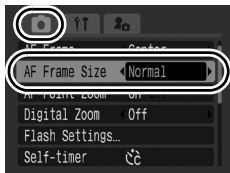
1. Press the  button.
2. In the  menu, use the  or  button to select [AF Frame Size].



2 Make settings.

1. Use the  or  button to select [Normal] or [Small].
2. Press the  button.

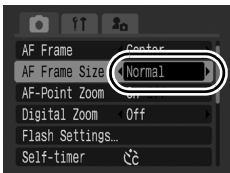

The setting is configured to [Normal] when the digital zoom or digital tele-converter is used.

Selecting a Subject to Focus On (Face Select and Track)





Available Shooting Modes >> p. 232

Once the focus is fixed to a subject's face, the frame can be set to follow the subject within a certain range.



To use the Face Select and Track function, first configure the following settings.

- Set [AF Frame] to [Face Detect] (p. 93).
- Register the  (Face Detect) function to the  button (p. 116).



1 Select a face you wish to focus on.

1. When a face is detected, press the  button.

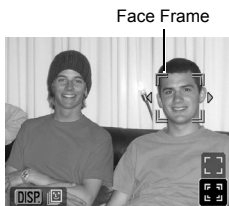
- The camera enters face designation mode, and the face frame () of the main subject displays in green. Even if the subject moves, the frame will follow the subject within a certain range.



2. Select the person you wish to focus on.

- When several faces have been detected, using the  or  button or control dial will move the face frame to another subject.
- The face frame will not display when a face is not detected.
- Holding down the **DISP.** button will display face frames (up to 35) of all the detected faces (green: face of main subject, white: detected faces).
- Pressing the  button will release the face designation mode.

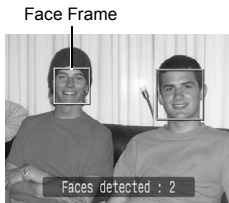

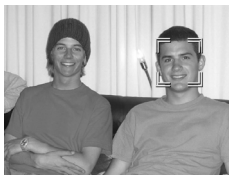

3. Press the  button again.

- The camera exits face designation mode, and the face frame () of the main subject will change to white (the frame will continue to follow the subject within a certain range).



2 Shoot.

1. Press the shutter button halfway.

- The face frame () of main subject will change into .

2. Press the shutter button fully.



In the following cases, the face select mode will be canceled.

- When turning the power back on
- Using the digital zoom
- When the **MENU** button is pressed to display the menu
- When a selected face cannot be tracked for several seconds
- When the display is turned off

Shooting Hard-to-Focus Subjects (Focus Lock, AF Lock)



Available Shooting Modes  [p. 232](#)

It may be difficult to focus on the following types of subjects.

- Subjects with extremely low contrast to the surroundings
- Scenes with a mixture of near and far subjects
- Subjects with extremely bright objects at the center of the composition
- Subjects that are moving quickly
- Subjects through glass

Shooting with the Focus Lock

You can operate in all shooting modes.

- 1 Aim the camera so that an object at the same focal distance as the main subject is centered in the viewfinder or in the AF frame displayed on the LCD monitor.**
- 2 Keep the shutter button pressed halfway while you recompose the image.**
- 3 Press the shutter button fully to shoot the image.**

Shooting with the AF Lock

- 1 Turn on the LCD monitor.**
- 2 Aim the camera so that an object at the same focal distance as the main subject is centered in the AF frame.**
- 3 Press and hold the shutter button halfway and press the  button.**
 - The **AF-L** icon will display.
- 4 Re-aim the camera to compose the shot as desired and shoot.**

To Release the AF Lock:

Press the  button.







- When shooting with the focus lock or AF lock using the LCD monitor, setting [AF Frame] to [Center] (p. 93) makes shooting easier since the camera focuses using the center AF frame only.
- The AF lock is convenient because you can let go of the shutter button to compose the image. Moreover, the AF lock is still effective after the picture is taken, allowing you to capture a second image with the same focus.
- AF frames do not display in movie mode.
- Try to shoot as close to the glass as possible to reduce the chances of light reflecting back off the glass when you shoot a subject through glass.

Locking the Exposure Setting (AE Lock)

Available Shooting Modes >> p. 232

You can set the exposure and focus separately. This is effective when the contrast is too strong between the subject and background or when a subject is backlit.

- 1 Turn on the LCD monitor.**
- 2 Press the  button and select  (flash off).**
- 3 Aim the camera at the subject on which you wish to lock the exposure.**
- 4 Press and hold the shutter button halfway and press the  button.**
 - The  icon will display.
- 5 Re-aim the camera to compose the shot as desired and press the shutter button fully.**

To Release the AE Lock:

Press the  button.







- In movie mode, AE lock can also be set/canceled (p. 85).
- You can use the FE lock when using the flash.

Locking the Flash Exposure Setting (FE Lock)



Available Shooting Modes >> p. 232

You can lock the flash exposure so that the exposure settings are correctly set regardless of the composition of your subject.

- 1 Turn on the LCD monitor.**
- 2 Press the  button and select  (flash on).**
- 3 Aim the camera at the subject on which you wish to lock the exposure.**
- 4 Press and hold the shutter button halfway and press the  button.**
 - The flash will pre-fire and  will display.
- 5 Re-aim the camera to compose the shot as desired and press the shutter button fully.**

To Release the FE Lock:







Press the  button.

Adjusting the Exposure Compensation

Available Shooting Modes >> [p. 232](#)

Adjust the exposure compensation to a positive value to avoid making the subject too dark when it is backlit or shot against a bright background. Adjust the exposure compensation to a negative value to avoid making the subject too bright in night shots or when shot against a dark background.

1 Configure the setting.

1. Press the  button.
2. Use the  or  button to select ± 0 and use the  or  button to adjust the exposure compensation.
3. Press the  button.



To Cancel the Exposure Compensation:

Restore the compensation value to [0].



In movie mode, the exposure shift can be set/canceled ([p. 85](#)).

Switching between Metering Modes



Available Shooting Modes >> p. 232

	Evaluative	Appropriate for standard shooting conditions, including backlit scenes. The camera divides images into several zones for metering. It evaluates complex lighting conditions, such as the position of the subject, the brightness, the direct light, and the backlighting, and adjusts the settings to the correct exposure for the main subject.
	Center Weighted Avg.	Averages the light metered from the entire frame, but gives greater weight to the subject matter at the center.
	Spot	Adjusts the exposure according to the subject in the center of the frame (meters the area within the spot AE point at the center of the LCD monitor). Use this mode when there is a large divergence in brightness between the subject and surroundings.

1 Change the metering mode.

1. Press the button.
2. Use the or button to select and the or button to change the option.
3. Press the button.



The metering method is fixed to Evaluative in the Long Shutter mode.

Setting the Shutter Speed (Long Shutter Mode)



Available Shooting Modes >> p. 232

You can set the shutter speed to a slow setting to make dark subjects appear brighter.

1 Select the Long Shutter Mode.

1. Press the button.
2. Use the or button to select .
3. Press the .



2 Change the shutter speed.

1. Use the or button to change the shutter speed.
2. Press the .

- The higher the value, the brighter the recorded image becomes.
- If you press the **DISP.** button at this point, you will return to the Exposure Compensation setting screen.





- The brightness of the image appearing on the LCD monitor and the recorded image may differ.
- The nature of CCDs is such that noise in the recorded image increases at long shutter speeds. This camera, however, applies special processing to images shot at shutter speeds of 1.3 seconds or slower to eliminate the noise, thereby producing high-quality images. A certain amount of processing time, however, may be required before the next image can be shot.









- Use the LCD monitor to confirm that the image was recorded at the desired brightness.
- Please note that camera shake becomes a factor at low shutter speeds. Shoot with the camera attached to a tripod.
- Use of the flash may result in an over-exposed image. If this occurs, shoot with the flash set to .







Adjusting the Tone (White Balance)

Available Shooting Modes  p. 232

Normally, the  (Auto) white balance setting selects an optimal white balance. When the  setting cannot produce natural looking colors, change the white balance using a setting appropriate for the light source.

	Auto	Settings are automatically set by the camera.
	Day Light	For recording outdoors on a bright day.
	Cloudy	For recording under overcast, shady or twilight skies.
	Tungsten	For recording under tungsten and bulb-type 3-wavelength fluorescent lighting.
	Fluorescent	For recording under warm-white, cool-white or warm-white (3-wavelength) fluorescent lighting.
	Fluorescent H	For recording under daylight fluorescent, or daylight fluorescent-type 3-wavelength fluorescent lighting.
	Custom	For recording with the optimal white balance data memorized in the camera from a white-colored object, such as white paper or cloth.

1 Select a white balance setting.

1. Press the  button.
2. Use the  or  button to select  and the  or  button to change the option.
3. Press the  button.





The white balance setting cannot be adjusted when or is selected for My Colors.

Using the Custom White Balance

Take a custom white balance (Custom) reading for the following situations that are difficult for the (Auto) setting to detect correctly.

- Shooting subjects of monotone color (such as sky, sea or forest)
- Shooting with a particular source of light (such as a mercury-vapor lamp)
- Shooting close-ups (Macro)

1 Select .

1. Press the button.
2. Use the or button to select and use the or button to select .





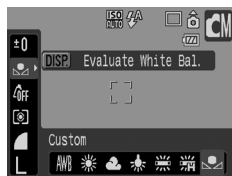

2 Aim the camera at a piece of white paper or cloth and press the button.

- Ensure that the LCD monitor is completely filled with the white image. Please note, however, that the center frame will not display when the digital zoom is used or when is displayed.
- You can also use the viewfinder to take a custom white balance reading.



3 Press the button.















- You are recommended to set the shooting mode to  and the exposure compensation setting to $[\pm 0]$ before setting a custom white balance. The correct white balance may not be obtained when the exposure setting is incorrect (image appears completely black or white).
- Shoot with the same settings as when reading the white balance data. If the settings differ, the optimal white balance may not be set. In particular, the following should not be changed.
 - ISO speed
 - Flash:
Setting the flash to  or  is recommended. If the flash fires when reading the white balance data with the flash set to , make sure that you also use the flash when you shoot.
- Since the white balance data cannot be read in Stitch Assist mode, preset the white balance in another shooting mode beforehand.
- The white balance data is retained even after the camera power is turned off.

Shooting in a My Colors Mode



Available Shooting Modes >> p. 232

You can change the look of an image when it is shot.

	My Colors Off	Records normally with this setting.
	Vivid	Emphasizes the contrast and color saturation to record bold colors.
	Neutral	Tones down the contrast and color saturation to record neutral hues.
	Sepia	Records in sepia tones.
	B/W	Records in black and white.
	Positive Film	Use this option to make blue, green or red colors more intense like the Vivid Blue, Vivid Green or Vivid Red effects. It can produce intense natural-appearing colors like those obtained with positive film.
	Lighter Skin*	Use this option to make skin tones lighter.
	Darker Skin*	Use this option to make skin tones darker.
	Vivid Blue	Emphasize blue tints. Use to make blue subjects, such as the sky or ocean, more vivid.
	Vivid Green	Emphasize green tints. Use to make green subjects, such as mountains, new growth, flowers and lawns, more vivid.
	Vivid Red	Emphasize red tints. Use to make red subjects, such as flowers or cars, more vivid.
	Custom Color	Use this option to adjust the contrast, sharpness or saturation settings or the color balance between red, green, blue and skin tones*. It can be used to make subtle adjustments, such as making blue colors more vivid or face colors brighter.

* If the image contains colors that are the same as human skin, those colors will also be changed. You may not obtain the expected results depending on the skin color.

☐OFF / **Av** / **AvN** / **Se** / **BW** / **Ap** / **AL** / **AD** / **AB** / **AG** / **AR**

1 Select a My Colors setting.

1. Press the **FUNC SET** button.
2. Use the **↑** or **↓** button to select **☐OFF** and the **←** or **→** button to change the option.
3. Press the **FUNC SET** button.

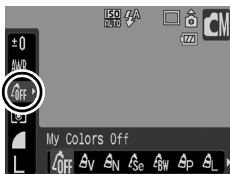

AC (Setting the Custom Color Mode)

1 Select **AC**.

1. Press the **FUNC SET** button.
2. Use the **↑** or **↓** button to select **☐OFF** and the **←** or **→** button to select **AC**.

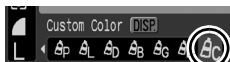

2 Adjust the setting.

1. Press the **DISP.** button.
2. Use the **↑** or **↓** button to select [Contrast], [Sharpness], [Saturation], [Red], [Green], [Blue] or [Skin Tone].
3. Use the **←** or **→** button to adjust the setting.



Select an item Adjust

- The adjustment results show in the LCD monitor.
- If you press the **DISP.** button, you will return to the screen where you can select a My Colors mode.



3 Press the button.

- Return to the shooting screen to shoot.

Changing the Colors and Shooting

Available Shooting Modes >> p. 232

You can easily change the colors in an image when it is shot both stills and movies, allowing you to enjoy producing various effects. Depending on the shooting conditions, however, the images may appear rough, or you may not get the expected color. Before photographing important subjects, we recommend taking trial shots and checking the results. By setting the [Save Original] function (p. 113) to [On] when shooting stills, you can also record both the altered image and the original, unaltered image.

	Color Accent	Use this option to have only the color specified in the LCD monitor remain and to transform all others to black and white.
	Color Swap	Use this option to transform a color specified in the LCD monitor into another. The specified color can only be swapped into one other color, and multiple colors cannot be chosen.





Depending on the scene being shot, the ISO speed may increase, increasing the amount of noise in the image.

Shooting with Color Accent Mode



1 Select the Color Accent mode.

Still image:

1. Set the mode dial to .
2. Use the control dial to select .





Movie:

1. Set the mode dial to .
2. Use the control dial to select .

**2 Press the  button.**

- The camera will switch to color input mode, and the display will alternate between the original image and the Color Accent image (using the previously set color).

**3 Aim the camera so that the color you wish to retain appears at the center of the LCD monitor and press the  button.**

- Only one color can be specified.
- You can use the  or  button or the control dial to specify the range of the colors that are retained.
 - 5 : Only takes the color that you want to retain.
 - +5 : Also takes colors close to the one that you want to retain.

4 Press the  button to complete the setting, then shoot.

- The default Color Accent is green.
- You may not obtain the expected results after color input mode if you use the flash.
- The specified Color Accent is retained even if the camera's power is turned off.

Shooting with Color Swap Mode

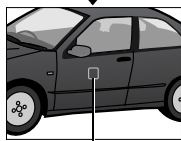
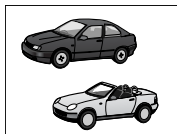

Original Color
(Before Swapping)

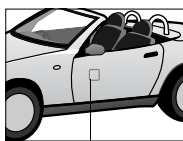

Desired Color
(After Swapping)

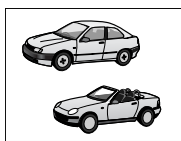

1 Select the Color Swap mode.

Still image:

1. Set the mode dial to M.
2. Use the control dial to select S.



Movie:

1. Set the mode dial to M.
2. Use the control dial to select S.



2 Press the button.

- The camera will switch to color input mode, and the display will alternate between the original image and the color swap image (using the previously set color).



3 Aim the camera so that the original color appears at the center of the LCD monitor and press the ← button.

- Only one color can be specified.
- You can use the ↑ or ↓ button or the control dial to specify the range of colors that are changed.
 - 5 : Only takes the color that you want to swap.
 - +5 : Also takes colors close to the one that you want to swap.

4 Aim the camera so that the desired color appears at the center of the LCD monitor and press the → button.

- Only one color can be specified.

5 Press the button to complete the setting, then shoot.



- The default setting for Color Swap changes green into white.
- You may not obtain the expected results if you use the flash.
- The colors specified in the Color Swap mode are retained even if the camera's power is turned off.

Saving Original Images



Not only can you save images with altered colors when shooting still images with the Color Accent or Color Swap modes, but you can also choose to save the original images (before the color change).

1 Select [Save Original].

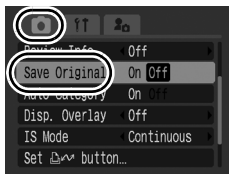
1. Press the  button.
2. In the  menu, use the  or  button to select [Save Original].



2 Make settings.

1. Use the  or  button to select [On] or [Off].
2. Press the  button.



If [Save Original] is set to [On]

- Only the transformed image displays in the LCD monitor while shooting in the Color Accent or Color Swap mode.
- The transformed image is reviewed in the LCD monitor after shooting in the Color Accent or Color Swap mode. If you erase the image at this point, the original image is erased along with the transformed image. Exercise adequate caution before deleting a file.
- The images are numbered consecutively. The original images are assigned the lower number and the transformed color accent or color swap images the next number.
- Since two images are recorded with each shot, the number of shots remaining is approximately half the number displayed when this function is set to [Off].

Setting the Display Overlays



Available Shooting Modes >> p. 232

You can display vertical and horizontal grid lines, a 3:2 print area guide, or both on the LCD monitor while shooting to help check the position of your subject.

Off	–
Grid Lines	Displays grid lines to divide the screen into 9 parts. Helps confirm the vertical and horizontal positioning of the subject.
3:2 Guide	Helps confirm the print area for L-size or postcard size in 3:2 aspect ratio*. Areas outside the printable area are grayed out. * Images are still recorded at the standard aspect ratio of 4:3.
Both	Displays both the grid lines and the 3:2 guide simultaneously.

1 Select [Disp. Overlay].

1. Press the button.
2. In the menu, use the or button to select [Disp. Overlay].



2 Make settings.

1. Use the or button to select the option.
2. Press the button.



- Only grid lines can be configured for the or mode.
- The grid lines and 3:2 guide will not be recorded in the image.

Categorizing Images Automatically (Auto Category)



Available Shooting Modes >> p. 232

If you set Auto Category to [On], images are automatically sorted into preset categories as they are recorded.

	People	For images shot in , or mode, or images with faces detected when [AF Frame] is set to [Face Detect].
	Scenery	For images shot in or mode.
	Events	For images shot in , , or mode.

1 Select [Auto Category].

1. Press the button.
2. In the menu, use the or button to select [Auto Category].

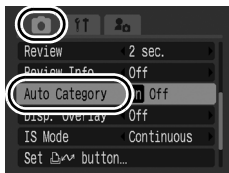

2 Make settings.

1. Use the or button to select [On] or [Off].
2. Press the button.















Movies are not automatically categorized, but they can be categorized using the My Category function (p. 124).

Registering Settings to the Button



Available Shooting Modes >> p. 232

You can register a function that you often use when shooting with the  button.

Menu Item	Page	Menu Item	Page
 Not Assigned	–	 Red-Eye Corr.	p. 80
 Face Select and Track	p. 96	 Digital Tele-converter	p. 65
 Exposure Compensation	p. 101	 DISP. Overlay	p. 114
 White Balance	p. 104	 Movies	p. 82
 Custom White Balance	p. 105	 Display Off	p. 117
		 Play Sound Effect*	p. 117





* Sets the sound registered to , found in the [Shutter Sound] section of the My Camera menu.

1 Select [Set button].



1. Press the  button.
2. In the  menu, use the  or  button to select [Set  button].
3. Press the  button.



2 Make settings.

1. Use the , , , or  button to select the function you wish to register.
2. Press the  button.
3. Press the  button.























- If  displays to the icon's lower right, you can register the function, but you cannot use it with some shooting modes or settings even if you press the  button.

To Cancel the Shortcut Button:

Select  in Step 2.

Using the Button

1 Press the button.

- For ,  and , each time that the  button is pressed, the settings of the registered functions are switched.
- For ,  and , the corresponding setup screen is displayed.
- For , each press of the  button records the white balance data. Since the frame does not appear at this point, ensure that the white paper or cloth is positioned so it appears at the center of the LCD monitor and then press the  button. After using this function once, the white balance setting changes to .
- For , the movie recording starts with the recording pixels and frame rate settings selected in the  (Standard) mode when you press the  button even if the mode dial is set to ,  or .
- For , pressing the  button turns off the LCD monitor. The next time a button is pressed, the LCD monitor will turn back on.
- For , this function is useful for directing your subject's attention to the camera right before taking a shot because it plays a sound when you press the  button.

Playback/Erasing

In playback mode, you can select images with the control dial. Turning it counterclockwise selects the previous image while turning it clockwise selects the next image. Please also see *Viewing Still Images* (p. 18).

🔍 Viewing Magnified Images



1 Press the zoom lever toward 🔍.

- A magnified portion of the image will display.
- Images can be magnified up to a factor of approximately 10x.



Approximate location of the displayed area

2 Use the ↑, ↓, ← or → button to move around the image.

- If you use the control dial while in the magnified display mode, the camera will switch to the previous or next image at the same level of magnification.
- You can change the magnification level with the zoom lever.

To Cancel the Magnified Display:

Press the zoom lever toward 🗄️. (You can also cancel it immediately by pressing the **MENU** button.)







Movie frames and index playback images cannot be magnified.

Viewing Images in Sets of Nine (Index Playback)



1 Press the zoom lever toward .

- Up to nine images can be viewed at once in index playback.
- Use the , ,  or  button or control dial to change the image selection.







To Return to Single Image Playback:

Press the zoom lever toward .

Switching between Sets of Nine Images

The jump bar will display if you press the zoom lever toward  while in index playback and you can switch the display between sets of nine images.

- Use the  or  button to move to the previous or next set of 9 images.
- Hold the **FUNC./SET** button down and press the  or  button to jump to the first or last set.

To Return to Single Image Playback:

Press the zoom lever toward .



Checking the Focus and Peoples' Expressions (Focus Check Display)



Focus Check display allows you to check the focus of images taken. Moreover, as you can change the display size and switch images, you can easily check facial expressions and whether a subject's eyes are closed.

Displaying the Focus Check

1

Press the  button several times until the Focus Check displays.

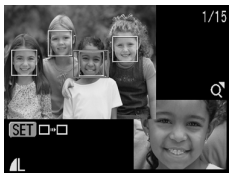

- Frames are displayed on the image as follows.

Frame color	Content
Orange	Displays the range of the image displayed at bottom right.
White	The frame is displayed at a position at which the image is in focus.
Gray	Displays frames in positions where faces were detected during playback.

- The orange frames allow you to change the display size, move the display position, and switch between display frames.





Changing the Display Size and Switching Frames

2 Press the zoom lever toward .

- Bottom right of the screen will be displayed prominently and the display size and display position can be changed.



3 Change the setting.

- You can change the display size by pressing the zoom lever.
- You can change the display position by using the , ,  or  button.
- When you press the **FUNC./SET** button, the orange frame returns to its original position.



To Cancel Changing the Display Position:

Press the **MENU** button.

Switching Frames







2 Press the button.

- When multiple in-focus frames are displayed, or when multiple faces are detected, the position of the orange colored frame will change each time the **FUNC./SET** button is pressed. After you change the display size, the orange frame will adjust to the size of the face when you switch the position of the frame.



Jumping to Images

When you have many images recorded onto a memory card, it is handy to use the search keys below to jump over images to find the object of your search.

	Jump Shot Date	Jumps to the first image of each shooting date.
	Jump to My Category	Jumps to the first image of each folder sorted by the Auto Category (p. 115) or My Category (p. 124) functions.
	Jump to Folder	Displays the first image in each folder.
	Jump to Movie	Jumps to a movie.
	Jump 10 images	Jumps over 10 images at a time.
	Jump 100 images	Jumps over 100 images at a time.

1 In single image playback mode, press the button.

- The camera will switch to jump search mode.

2 Use the or button to select a search key.

- The screen sample will vary slightly according to the search key.
- You can show/hide image information using the **DISP.** button.



Image Information

3 Display the Images.

Selected

- Use the or to select date, category or folder for playback.
 - You can check the target image by using the control dial.
 - If you select when an image has not been assigned to any category, you will only be able to select (none) as a search key.



Select the search key

- Press the button.

- The camera will switch to defined playback mode and display a blue frame. You can limit playback to the images corresponding to the search key.
- Press the button to cancel defined playback mode.

Selected

- Press the or button.

- Pressing the **MENU** button cancels the setting.
- Press the **FUNC./SET** button to switch the camera to defined playback mode when is selected.



The defined playback mode will be canceled under the following circumstances.

- Changing categories (while using My Category to define images).
- When selecting images in a range
- When displaying images not supported in defined playback
- When newly saving images that have effects added or edited
- When images are deleted using [Erase] from the menu

Organizing Images by Category (My Category)



You can organize images into prepared categories. The following operations can be performed if the images are sorted into categories.

- Image searches (p. 122)
- Slide Show (p. 136)
- Protect (p. 154)
- Erase (p. 158)
- Configure print settings (p. 165)

	People
	Scenery
	Events

	My Category 1 – 3
	To Do

Category Selection Methods

Select	For viewing and selecting images singly.
Select Range	For picking a first and last image and selecting all the images in the range.

1 Select [My Category].

1. Press the button.
2. In the menu, use the or button to select .
3. Press the button.

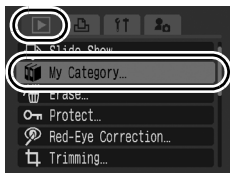

2 Choose a selection method.

1. Use the or button to choose a selection method.
2. Press the button.

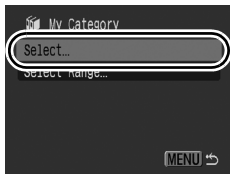

[Select]**3 Categorize the images.**



1. Use the **←** or **→** button to select images to categorize.
2. Use the **↑** or **↓** button to select a category.
3. Press the  button.



- Pressing the **FUNC./SET** button again cancels the setting.
- This also can be set in the index playback mode.
- Press the **MENU** button to complete the setting.

[Select Range]**3 Select the first image.**

- You can use the control dial to select the first or last image.

1. Press the  button.
2. Use the **←** or **→** button to select the first image in the range to categorize.
3. Press the  button.



4 Select the last image.

1. Use the **→** button to highlight the last image window.
2. Press the **FUNC SET** button.
3. Use the **←** or **→** button to select the last image in the range to categorize.
4. Press the **FUNC SET** button.
 - An image with a lower number than the first image cannot be selected as the last image.
 - Up to 500 images can be selected.



5 Select a category.

1. Press the **↓** button.
2. Use the **←** or **→** button to select a category.

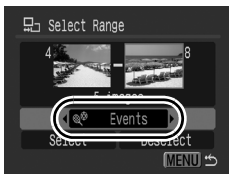

6 Make settings.

1. Press the **↓** button to choose [Select].
2. Press the **FUNC SET** button.
 - The screen will return to the selection method screen.
 - Selecting [Deselect] cancels categorization of the selected range.



Trimming a Portion of an Image



You can trim a required portion of a recorded image and save it as a new image file.

1 Select [Trimming].

1. Press the  button.
2. In the  menu, use the  or  button to select .
3. Press the  button.



2 Select an image.

1. Use the  or  button to select an image for trimming.
2. Press the  button.
 - The trimming frame (the area of the image which can be trimmed) is displayed in green.

Trimming Frame





Image After Trimming

3 Adjust the trimming frame.

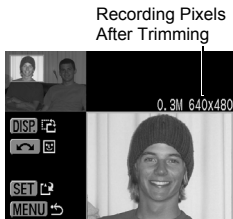
- You can change the size of the trimming frame using the zoom lever. However, the number of the recording pixels of the saved image will differ according to the size of the trimmed image.
- You can change the position of the trimming frame using the \uparrow , \downarrow , \leftarrow or \rightarrow button.
- Press the **DISP.** button to change the vertical/horizontal orientation of the trimming frame.
- If a face is detected, a gray frame appears around the face displayed in the top left screen. Trimming can be performed around this gray frame. If multiple frames are displayed, you can switch between frames by turning the control dial.





4 Save the image.

1. Press the  button.
2. Use the \leftarrow or \rightarrow to select [OK].
3. Press the  button.

- The trimmed image will be saved in a new file.
- If you wish to continue trimming of another image, repeat operations from Step 2.



5 Display the saved image.

1. Press the  button.
2. Use the \leftarrow or \rightarrow button to select [Yes].
3. Press the  button.

- Selecting [No] returns to the Play menu.





- Movies, **S** or **XS** images, and images recorded in **W** cannot be trimmed.
- Some images shot with another camera cannot be trimmed.
- The aspect ratio for images which can be trimmed will be fixed to 4:3 (or 3:4 if the image is vertically oriented).
- The recording pixels of a trimmed image will be less than the image before trimming.

Viewing Movies



1 Display a movie.

1. Use the **←** or **→** button to select a movie.
 2. Press the **FUNC./SET** button.
- Images with a **SET** icon are movies.



2 Play the movie.

1. Use the **←** or **→** button to select .
2. Press the **FUNC./SET** button.









- The movie will pause if you press the **FUNC./SET** button during playback. It will resume when you press the button again.
- When playback ends, the movie stops at the last frame displayed. Press the **FUNC./SET** button to display the movie control panel.
- You can switch between showing/hiding the playback progress bar by pressing the **DISP.** button while playing a movie.
- If playback was halted partway through in the prior viewing session, playback will resume from the last frame displayed.

Movie Control Panel



Operating the Movie Control Panel

Use the **←** or **→** button to select a control and press the **FUNC./SET** button.

	Exit	Ends playback and returns to single image playback.
	Print	An icon will display when a printer is connected. See the <i>Direct Print User Guide</i> for details.
	Play	Starts playback.
	Slow Motion	You can use the ← button to slow down or the → button to speed up playback.
	First Frame	Displays the first frame.
	Previous Frame	Rewinds if the FUNC./SET button is held down.
	Next Frame	Fast Forwards if the FUNC./SET button is held down.
	Last Frame	Displays the last frame.
	Edit	Switches to the movie editing mode.



Movies cannot be played in the index playback mode.



- Use the television's controls to adjust the volume when playing a movie on a TV set (p. 186).
- The sound cannot be played in slow motion playback or .

Editing Movies



You can delete portions of recorded movies.



Movies 1 second or longer before editing can be edited in 1-second increments, but those that are protected or less than 1 second long (15 seconds*¹ or 30 seconds*² in ) cannot be edited.

*1 [Interval Time]: 1 second *2 [Interval Time]: 2 seconds

1

Select [Edit].







1. Use the  or  button to select .





2. Press the  button.

- The movie editing panel and the movie editing bar will display.









2 Edit the movie.

1. Use the  or  button to select  (Cut Beginning) or  (Cut End).
2. Use the  or  button to specify the cut point (.

- While moving the cut point using the  or  button,  is displayed at each 1 second interval (or every 15 second*¹ or 30 second*² interval in ) , allowing you to cut the movie at the indicated point.

*1 When the shooting interval is 1 sec.

*2 When the shooting interval is 2 sec.





- Even if you specify the cut point at a position other than , selecting  will delete the beginning portion of the movie up to the  point just before your specified cut point, and selecting  will delete the latter portion of the movie from the  point just after your specified cut point. The edited movie will be saved.
- To check a temporarily edited movie, select  (Play) and press the **FUNC./SET** button.
- To continue editing, repeat Step 2.
- Selecting  (Exit) cancels the edit and restores the movie control panel.

Movie Editing Panel



Movie Editing Bar

3 Select [Save].

1. Use the  or  button to select .
2. Press the  button.

4 Save the file.

1. Use the **↑**, **↓**, **←** or **→** button to select [New File] or [Overwrite].
2. Press the  button.

- [New File] saves the edited movie under a new file name. The pre-edit data is left unchanged. Note, if you press the **FUNC./SET** button while saving the movie, saving is canceled.
- [Overwrite] saves the edited movie with its original name. The pre-edit data is lost.
- When there is not enough space left on the memory card, only [Overwrite] can be selected.



Depending on the movie's file size, it may take some time to save an edited movie. If the battery runs out of charge partway through, edited movie clips cannot be saved. When editing movies, it is recommended to use a fully charged battery or the separately sold AC Adapter Kit ACK-DC30 (p. 214).

Rotating Images in the Display



Images can be rotated clockwise 90° or 270° in the display.



Original



90°



270°

1 Select [Rotate].

1. Press the button.
2. In the menu, use the or button to select .
3. Press the button.

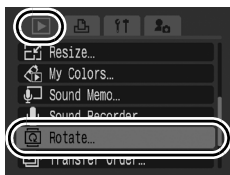

2 Rotate the image.

1. Use the or button to select an image to rotate.
2. Press the button.
 - Cycle through the 90°/270°/original orientations with each press of the **FUNC./SET** button.
 - This also can be set in the index playback mode.





When images are downloaded to a computer, the orientation of images rotated by the camera will depend upon the software used to download the images.



As the orientation of an image is recorded, the image will be shown in its rotated orientation the next time it is displayed.

Playback with Transition Effects

You can select the transition effect displayed when switching between images.

	No transition effect.
	The displayed image darkens and the next image gradually brightens until it is displayed.
	Press the ← button to have the previous image display from the left and the → button to have the next image display from the right.

1 Select [Transition].

1. Press the  button.
2. In the  menu, use the ↑ or ↓ button to select .



2 Make settings.







1. Use the ← or → button to select a transition effect.
2. Press the  button.



Automated Playback (Slide Shows)

Automated playback of memory card images.

Image settings for slide shows are based on the Digital Print Order Format (DPOF) standard (p. 165).

	All Images	Plays all images on a memory card in order.
	Date	Plays images bearing a specified date in order.
	My Category	Plays the images in the selected category in order.
	Folder	Plays images in a specified folder in order.
	Movies	Plays movie files only, in order.
	Stills	Plays still images only, in order.
	Custom 1 – 3	Plays the images selected for each slide show, Custom 1, Custom 2 or Custom 3, in order (p. 140).

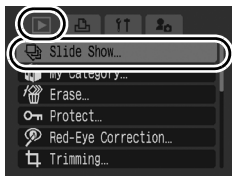

1 Select [Slide Show].

1. Press the  button.
2. In the  menu, use the  or  button to select .
3. Press the  button.



2 Select a playback method.

1. Press the **▲** button.
2. Use the **◀** or **▶** button to select the slide show type.

- , ,  : Press the **FUNC./SET** button to select a date, category or folder to be played back (p. 139).
- ***1** – ***3** : Press the **FUNC./SET** button to select the images to be played back (p. 140).
- If you want to add a transition effect to play back images, use the **▲** button to select [Effect] and choose the type of effect with the **◀** or **▶** button (p. 138).



3 Start the slide show.

1. Press the **▼** button.
2. Use the **◀** or **▶** button to select [Start].
3. Press the  button.

- The following functions are available during slide shows.
 - Pausing/resuming: Press the **FUNC./SET** button.
 - Fast forwarding/rewinding: Press the **◀** or **▶** button (continue to hold the button to switch between images more rapidly).







To Stop the Slide Show:

Press the **MENU** button.

Transition Effects

You can select the transition effect used when one image is replaced by another.

	No transition effect.
	The new image gradually brightens as it moves upward from the bottom.
	The new image first appears in a cross shape and gradually expands to display the full image.
	Portions of the new image move horizontally, then the image expands to display the full image.



In single image playback mode, you can start a slide show from the current image displayed by holding the **FUNC./SET** button while you press the  button. Please note that if you do this while the last image shot is displayed, the slide show will start from the first image using the same date.



Select a date/category/folder to play back (, ,)

1 Select a playback method.



1. Use the  or  button to select ,  or .
2. Press the  button.



2 Select images to play back.

1. Use the  or  button to select a date/category/folder to playback.
2. Press the  button.



- A  will appear on selected images.
- To cancel the selection: Press the **FUNC./SET** button again.
- Multiple selections can be made for the date/category/folder.
- The images will play back in the order of selection.
- You can check the images for each date/category/folder by using the  or  button.
- Pressing the **MENU** button completes the setting.

Selecting Images for Playback (*1 - *3)

Select only the images that you wish to play back and save them as a slide show (Custom 1, 2 or 3). Up to 998 images can be selected. They will be played back in their order of selection.

1

Select a playback method.

- Use the ◀ or ▶ button to select *1, *2 or *3.

- Only the *1 icon will display at first.

- Press the  button.

- When you set *1, the icon will change to *1✓ and *2 will display. *2 and *3 will change in the same way when they are set.



2

Select images to play back.

- Use the ◀ or ▶ button to choose images to play back.

- Use the  button to select/deselect the images.

- You can also select images in the index playback mode.
- Pressing the **MENU** button completes the setting.

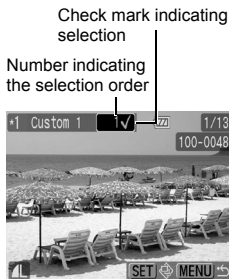



Selecting All Images

- 1 After selecting **1** – **3** in Step 1, use the **▲** button to select [Mark all] and press the **FUNC./SET** button.
- 2 Use the **▲** button to select [Mark all], press the **FUNC./SET** button.
- 3 Use the **▶** button to select [OK] and press the **FUNC./SET** button.

To deselect all images, select [Reset].

Adjusting the Play Time and Repeat Settings

• Play Time

Sets the duration that each image displays. Choose between 3 – 10 seconds, 15 seconds and 30 seconds. Displaying time can vary slightly depending on the image.

• Repeat

Sets whether the slide show stops when all the slides have been displayed or continues until stopped.

1

Select [Set up].

1. Use the **◀** or **▶** button to select [Set up].
2. Press the **FUNC./SET** button.



2

Configure the setting.

1. Use the **▲** or **▼** button to select [Play Time] or [Repeat].
2. Use the **◀** or **▶** button to select a setting.
3. Press the **MENU** button.



Red-Eye Correction Function



You can correct red eyes in recorded images.



Red eyes may not be automatically detected in some images or the results may not turn out as you intended.

We recommend that you use [New File] to save corrected images.

Examples:

- Faces near the screen edges or faces that appear extremely small, large, dark or bright in relation to the overall image.
- Faces turned to the side or at a diagonal, or faces with a portion hidden.

1 Select [Red-Eye Correction].

1. Press the button.
2. In the menu, use the or button to select .
3. Press the button.



2 Select an image.

1. Use the or button to select the image you wish to correct red eyes.
2. Press the button.

- A frame will automatically display where red-eye is detected.
- If red-eye is not automatically detected, select [Add Frame] with the or button and press **FUNC./SET** button (p. 145).
- To cancel the correction frame, select [Remove Frame] and press the **FUNC./SET** button (p. 146).



3 Correct the image.

1. Use the **↑**, **↓**, **←** or **→** button to select [Start].
2. Press the  button.





4 Save the image.

1. Use the **↑**, **↓**, **←** or **→** button to select [New File] or [Overwrite].
2. Press the  button.



- [New File]: Saved as new file with a new name. The uncorrected image is stored. The new image is stored as the last file.
- [Overwrite]: Saved with the same file name as the uncorrected image. The uncorrected image is erased.
- When [New File] is selected, proceed to Step 5.
- If you wish to continue correcting another image, repeat operations from Step 2.

5 Display the saved image.

1. Press the  button.
2. Use the **←** or **→** button to select [Yes].
3. Press the  button.

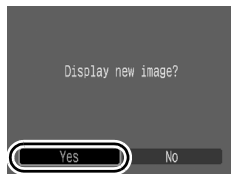

- Selecting [No] returns to the Play menu.



- Red-eye correction cannot be performed on movies.
- Overwriting cannot be performed on protected images.



- When there is not enough space left on the memory card, red-eye correction cannot be performed.
- Although you can apply red-eye correction any number of times to an image, the image quality will gradually deteriorate with each application.
- Since the correction frame will not appear automatically on images that have already been corrected once with the Red-Eye Correction function, use the [Add Frame] option to correct them.

Add Correction Frame

1 Select [Add Frame].

1. Use the \uparrow , \downarrow , \leftarrow or \rightarrow button to select [Add Frame].
2. Press the  button.

- A green frame will display.



2 Adjust the position of the correction frame.

1. Use the \uparrow , \downarrow , \leftarrow or \rightarrow button to move the frame.

- Size of the frame can be changed with the zoom lever.



3 Add additional correction frames.

1. Press the  button.

- A correction frame is added and the frame color changes to white.
- If you wish to add additional frames, adjust the position and press the **FUNC./SET** button.
- Up to 35 additional frames can be added.
- To end the adding of correction frames, press the **MENU** button.



To correctly perform red-eye correction, take note of the following (refer to the image in Step 2):

- Adjust the correction frame size so that it only surrounds the red-eye portion to be corrected.
- When there are several subjects with red-eye, be sure to add one correction frame per subject.

Removing Correction Frames

1 Select [Remove Frame].

1. Use the **↑**, **↓**, **←** or **→** button to select [Remove Frame].
2. Press the  button.



2 Select a frame you wish to remove.

1. Use the **←** or **→** button to select a frame to remove.
- The selected frame will appear in green.



3 Delete the frame.

1. Press the  button.
- The selected frame will disappear.
 - To continue deleting frames, repeat operations from Step 2.
 - When you finish deleting frames, press the **MENU** button.

Adding Effects with the My Colors Function



You can add effects to recorded images (stills only) using the My Colors function. The following selection of My Colors effects is available. For details, see [p. 107](#).

Vivid	Lighter Skin Tone
Neutral	Darker Skin Tone
Sepia	Vivid Blue
B/W	Vivid Green
Positive Film	Vivid Red

1 Select [My Colors].

1. Press the button.
2. In the menu, use the or button to select .
3. Press the button.



2 Select an image.

1. Use the or button to select an image.
2. Press the button.



3 Select a My Colors type.

- Use the ◀ or ▶ button to select the My Colors type.
 - The displayed image will reflect the My Colors effect.
 - You can press the zoom lever toward 🔍 to check the image at a higher magnification. While the image is zoomed, you can press the **FUNC./SET** button to switch between the image transformed with the My Colors effect and the original non-transformed image.
- Press the  button.





4 Save the image.

- Use the ◀ or ▶ button to select [OK].
- Press the  button.
 - The newly saved image transformed with the My Colors effect will be the last one in the list.
 - To continue adding effects to other images, repeat the procedures from Step 2 onward.



5 Display the saved image.

- Press the  button.
- Use the ◀ or ▶ button to select [Yes].
- Press the  button.
 - Selecting [No] returns to the Play menu.





- When there is not enough space left on the memory card, the My Colors effects cannot be added.
- Although My Colors effects can be added any number of times to an image, the image quality will gradually deteriorate with each application and the intended colors may not be achieved.
- Color in images taken using My Colors (p. 107) in shooting mode and images edited with the My Colors function in playback mode may differ slightly.

Resizing Images



You can resave images that were recorded at high recording pixel settings at lower settings.

M3	1600 × 1200 pixels
S	640 × 480 pixels
XS	320 × 240 pixels

1 Select [Resize].

1. Press the **MENU** button.
2. In the  menu, use the **↑** or **↓** button to select .
3. Press the **FUNC./SET** button.



2 Select an image.

1. Use the **←** or **→** button to select an image to resize.
 2. Press the **FUNC./SET** button.
- The **FUNC./SET** button is not selectable for images that cannot be resized.



3 Select a resolution.

1. Use the **←** or **→** button to select a resolution.
2. Press the **FUNC SET** button.
 - If a resolution cannot be selected due to a lack of free space on the memory card, **⊘** will display.



4 Save the image.

1. Use the **←** or **→** button to select [OK].
2. Press the **FUNC SET** button.
 - The resized image will be saved in a new file. The original image will remain.
 - If you wish to continue resizing of another image, repeat operations from Step 2.



5 Display the saved image.

1. Press the **MENU** button.
2. Use the **←** or **→** button to select [Yes].
3. Press the **FUNC SET** button.
 - Selecting [No] returns to the Play menu.



Movies and images shot in **WV** mode cannot be resized.

Attaching Sound Memos to Images



In playback mode, you can attach sound memos (up to 1 min.) to an image. The sound data is saved in the WAVE format.

1 Select [Sound Memo].

1. Press the button.
2. In the menu, use the or button to select .
3. Press the button.



2 Select an image.

1. Use the or button to select an image to which you wish to attach a sound memo.
2. Press the button.

- The sound memo control panel will display.



3 Record the memo.

1. Use the or button to select .
2. Press the .

- The elapsed time and the remaining time display.
- Pressing the **FUNC./SET** button pauses the recording. Pressing it again resumes recording.
- Up to 1 minute of recordings can be added to any one image.
- Press the **MENU** button several times to complete the setting.

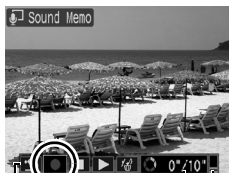





Sound Memo Panel

Elapsed Time/
Remaining Time

Volume _____
(Adjust it with the or button)

Sound Memo Panel

Use the ← or → button to select an option and press **FUNC./SET** button.

	Exit	Returns to the playback screen.
	Record	Starts recording.
	Pause	Pauses recording or playback.
	Play	Begins playback.
	Erase	Erases sound memos. (Select [Erase] and in the confirmation screen press the FUNC./SET button.)



- You cannot attach sound memos to movies.
- Sound memos for protected images cannot be erased.

Sound-Only Recording (Sound Recorder)



You can record sound only, without images, for up to two hours at one time.

1 Select [Sound Recorder].

1. Press the  button.
2. In the  menu, use the ↑ or ↓ button to select .
3. Press the  button.



2 Record a sound.

1. Use the ◀ or ▶ to select .
2. Press the  button.

- The elapsed recording time displays.
- You can use the ▲ or ▼ button to change the sampling rate. The recording quality rises progressively as you select [11.025 kHz], [22.050 kHz] or [44.100 kHz], but the recorded file sizes increase correspondingly.
- Press the **FUNC./SET** button to stop the recording session. Pressing the button again starts a new recording session.

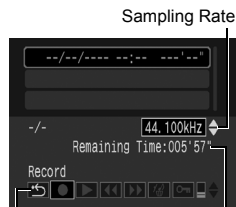









Sound Recorder Panel

Remaining Time

Sound Recorder Panel

Use the ◀ or ▶ button to select an option and press **FUNC./SET** button.

	Exit	Returns to the menu screen.
	Record	Starts recording.
	Pause	Stops recording, playback.
	Play	Use the ▲ or ▼ button to select a sound to play and press the FUNC./SET button.
	Rewind	Holding down the FUNC./SET button rewinds. The sound cannot be heard while rewinding.
	Fast Forward	Holding down the FUNC./SET button fast forwards. The sound cannot be heard while fast forwarding.
	Erase	Select [Erase] or [Erase all] in the confirmation screen and press the FUNC./SET button.
	Protect	Protects against accidental erasure. Use the ▲ or ▼ button to select a sound and the FUNC./SET button to select/deselect protection.
	Volume	You can use the ▲ or ▼ button to adjust the volume.



- See *Sound Recorder Data Rates and Recording Durations (Estimated)* (p. 224).
- Recording will automatically stop when the memory card is full.

Protecting Images



You can protect important images and movies from accidental erasure.



Select	You can configure the protection settings for each image singly while viewing them.
Select Range	You can select a first and last image and protect all the images in the range.
Select by Date	You can protect the images from a specified date.
Select by Category	You can protect the images in a specified category.
Select by Folder	You can protect the images in a specified folder.
All Images	You can protect all the images on a memory card.

1 Select [Protect].

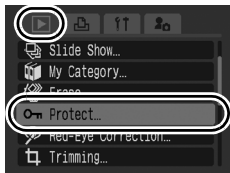
1. Press the  button.
2. In the  menu, use the  or  button to select .
3. Press the  button.



2 Choose a selection method.

1. Use the  or  button to choose a selection method.
 - Pressing the **MENU** button returns to the prior screen.
2. Press the  button.

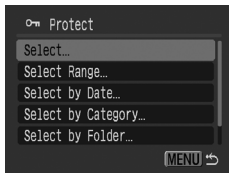

[Select]**3 Protect the image.**

1. Use the ◀ or ▶ button to select an image to protect.

2. Press the  button.

- Pressing the **FUNC./SET** button again cancels the setting.
- To continue protecting other images, repeat the procedure.
- You can also protect images in the index playback mode.
- Press the **MENU** button to complete the setting.



Protection Icon

[Select Range]**3 Select the first image.**

• You can use the control dial to select the first or last image.



1. Press the  button.

2. Use the ◀ or ▶ button to select the first image in the range to protect.

3. Press the  button.



4 Select the last image.

1. Use the **▶** button to switch to selecting the last image.
2. Press the  button.
3. Use the **◀** or **▶** button to select the last image in the range.
4. Press the  button.
 - An image with a lower number than the first image cannot be selected as the last image.
 - Up to 500 images can be selected.



5 Protect the images.

1. Press the **▼** button to select [Protect].
2. Press the  button.
 - The screen will return to the selection method screen.
 - Selecting [Unlock] cancels selection of the protected image.



[Select by Date]/[Select by Category]/[Select by Folder]

3 Select the images.

- Use the **▲** or **▼** button to select a date/category/folder to protect.
- Press the **FUNC./SET** button.
 - A **✓** will appear on selected images.
 - Pressing the **FUNC./SET** button again cancels the setting.
 - You can select multiple dates, categories or folders.
 - Use the **◀** or **▶** button to confirm each date, category or folder image.
- Press the **MENU** button.



4 Protect the images.

- Use the **▲** or **▼** button to select [Protect].
- Press the **FUNC./SET** button.
 - Returns to the selection method screen.
 - Selecting [Unlock] removes protection for the selected images.
 - Selecting [Stop] cancels protection settings for the current selection.



[All Images]

3 Protect the images.

1. Use the **↑** or **↓** button to select [Protect].
2. Press the  button.

- Returns to the selection method screen.
- Selecting [Unlock] removes protection for all the images.
- Selecting [Stop] cancels protection settings for the current selection.



Erasing Images



You can erase images from a memory card.

Select	Erase images after selecting them one at a time.
Select Range	For picking a first and last image and erasing all the images in the range.
Select by Date	Erases images corresponding to the selected date.
Select by Category	Erases images in the selected category.
Select by Folder	Erases images in the selected folder.
All Images	Erases all images on a memory card.





- Note that erased images cannot be recovered. Exercise adequate caution before erasing an image.
- Protected images cannot be erased with this function.

1 Select [Erase].

1. Press the  button.
2. In the  menu, use the  or  button to select .
3. Press the  button.





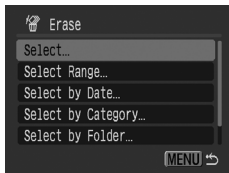

2 Select an erasure method.

1. Use the  or  button to select an erasure method.
 - Pressing the **MENU** button returns to the prior screen.
2. Press the  button.



[Select]

3 Select the image.

1. Use the  or  button to select an image to erase.
2. Press the  button.
 - Pressing the **FUNC./SET** button again deselects the setting.
 - This also can be set in the index playback mode.
3. Press the  button.



4 Erase the image.



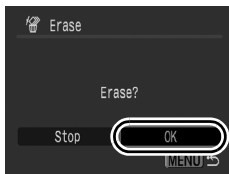

1. Use the  or  button to select [OK].
2. Press the  button.
 - Selecting [Stop] cancels selection of the image you are about to erase and returns to Step 2.



[Select Range]





3 Select the first image.

- You can use the control dial to select the first or last image.

- Press the  button.
- Use the  or  button to select the first image in the range to erase.
- Press the  button.



4 Select the last image.

- Use the  button to switch to selecting the last image.
- Press the  button.
- Use the  or  button to select the last image in the range.
- Press the  button.

- An image with a lower number than the first image cannot be selected as the last image.
- Up to 500 images can be selected.



5 Erase the images.

1. Press the **↓** button to select [Erase].
2. Press the **FUNC./SET** button.

- Pressing the **MENU** button cancels selection of the image you are about to erase and returns to Step 2.



[Select by Date]/[Select by Category]/[Select by Folder]

3 Select the images.

1. Use the **↑** or **↓** button to select a date/category/folder to erase.

2. Press the **FUNC./SET** button.

- A **✓** will appear on selected images.
- Pressing the **FUNC./SET** button again cancels the setting.
- You can select multiple dates, categories or folders.
- Use the **←** or **→** button to confirm each date, category or folder image.

3. Press the **MENU** button.



4 Erase the images.

1. Use the **←** or **→** button to select [OK].

2. Press the **FUNC./SET** button.

- Selecting [Stop] cancels selection of the image you are about to erase and returns to Step 2.

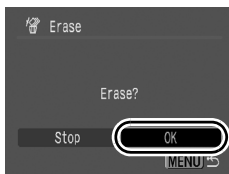

[All Images]

3 Erase the images.

1. Use the ← or → button to select [OK].

2. Press the  button.



- Selecting [Cancel] cancels selection of the image you are about to erase and returns to Step 2.



- Pressing the **FUNC./SET** button while erasing is in progress cancels the procedure.
- Please format the memory card when you want to erase not only image data but also all the data contained on the memory card ([p. 178](#)).

Registering Functions to the Button

You can register a function that you often use to the  button. The following functions can be registered.

	Function	Reference Page
	Standard* ¹	–
	Slide Show* ²	p. 136
	Sound Recorder	p. 152

*1 Default setting (It can be used to switch between power off/playback mode/shooting mode (p. 44).



*2 Slide Show will not play in the index playback mode.

1 Select [Set Play button].

1. Press the  button.
2. In the  menu, use the  or  button to select .
3. Press the  button.



2 Make settings.

1. Use the  or  button to select a function you wish to register.
2. Press the  button.



To cancel:



Select  in Step 2.

Using the Button

1 In playback mode, press the button.

- This will call up the registered function.



- When you press the  button in shooting mode, it switches the camera to playback mode. Then when it is pressed a second time, the registered function is called up.
- Registering a function other than  to the  button disables its ability to turn off the camera power.

Print Settings/Transfer Settings

You can also use the control dial to select images and perform various operations. See [p. 43](#).

Setting the DPOF Print Settings

You can select images on a memory card for printing and specify the number of print copies in advance using the camera. The settings used on the camera comply with the Digital Print Order Format (DPOF) standards. This is extremely convenient for printing on a direct print compatible printer, or for sending the images to a photo developing service that supports DPOF.







- The specified print settings are also applied to the Print List ([p. 21](#)).
- The output of some printers or photo developing services may not reflect the specified print settings.
- Print settings cannot be set for movies.
- The  icon may display for a memory card with print settings set by a different DPOF-compliant camera. These settings will be overwritten by those set by your camera.









Setting the Print Style

After setting the print style, select the images for printing. The following settings can be selected.

* Default setting





Print Type	 Standard*	Prints one image per page.
	 Index	Prints the selected images together at a reduced size in an index format.
	 Both	Prints the images in both the standard and index formats.
 Date (On/Off*)		Adds the date to the print.
 File No. (On/Off*)		Adds the file number to the print.
Clear DPOF data (On*/Off)		Clears all print settings after the images print.

1 Select [Print Settings].



1. Press the  button.
2. Press the  button.
3. Use the  or  button to select the  menu.
4. Use the  or  button to select [Print Settings].
5. Press the  button.

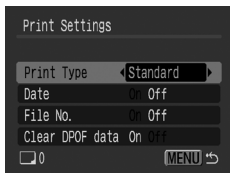

2 Make settings.

1. Use the  or  button to select an option.
2. Use the  or  button to specify the settings.
3. Press the  button.



- The Date and File No. settings change according to the Print Type as follows.
 - [Index]:
[Date] and [File No.] cannot be set to [On] at the same time.
 - [Standard] or [Both]:
[Date] and [File No.] can be set to [On] at the same time, however, the printable information may vary between printers.
- Images dated using  (Date Stamp) (p. 22) are always printed with the date, regardless of the [Date] setting. As a result, some printers may print the date twice on these images if [Date] is also set to [On].
- Dates print in the style specified in [Date/Time] in the  menu (pp. 14, 58).









Select a print settings method

Select Images & Qty.	Configures print settings for single images as you view them.
Select Range	For picking a first and last image and printing all the images in the range.
Select by Date	Configures print settings for images corresponding to the selected date.
Select by Category	Configures print settings for images in the selected category.
Select by Folder	Configures print settings for images in the selected folder.
Select All Images	Configures print settings for all images.
Clear All Selections	Removes all print settings from images.



Only one copy will be printed for each selected image. With the [Select Images & Qty.] option, you can only set the number of copies to print when the [Print Type] option is set to [Standard] or [Both] (p. 165).

1 Choose a selection method.

1. Press the  button.
2. Press the  button.
3. Use the  or  button to select the  menu.
4. Use the  or  button to choose a selection method.
5. Press the  button.





[Select Images & Qty.]



2 Select the images.

Selection methods differ depending on the Print Type settings (p. 165).

Standard (■)/Both (■) (■)

1. Use the ◀ or ▶ button to select the images.
2. Press the  button.
3. Use the ▲ or ▼ button to select the number of print copies (up to 99).
4. Press the  button.

Index (■)

1. Use the ◀ or ▶ button to select the images.
 2. Select and deselect with  button.
 3. Press the  button.
- This also can be set in the index playback mode.

Number of Print Copies







Index Print Selection



[Select Range]





2 Select the first image.

- You can use the control dial to select the first or last image.

- Press the  button.
- Use the  or  button to select the first image in the print range.
- Press the  button.



3 Select the last image.

- Use the  button to switch to selecting the last image.
 - Press the  button.
 - Use the  or  button to select the last image in the range.
 - Press the  button.
- An image with a lower number than the first image cannot be selected as the last image.
 - Up to 500 images can be selected.



4 Configure the print settings.



1. Press the **↓** button to select [Order].
2. Press the  button.

- The screen will return to the selection method screen.
- Pressing the **MENU** button cancels the print settings for the selected range of images.



[Select by Date]/[Select by Category]/[Select by Folder]

2 Select the images.

1. Use the **↑** or **↓** button to select a date/category/folder to print.
2. Press the  button.
 - A **✓** will appear on selected images.
 - Pressing the **FUNC./SET** button again cancels the setting.
 - You can select multiple dates, categories or folders.
 - Use the **←** or **→** button to confirm each date, category or folder image.
3. Press the  button.



3 Configure the print settings.

1. Use the **←** or **→** button to select [OK].
2. Press the  button.

- The screen will return to the selection method screen.
- Selecting [Stop] cancels print settings of the selected image.



[Select All Images]

2 Configure the print settings.

1. Use the ← or → button to select [OK].

2. Press the  button.

- The screen will return to the selection method screen.
- Selecting [Cancel] cancels print settings of the selected image.

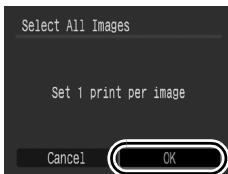

[Clear All Selections]



2 Deselect the images.

1. Use the ← or → button to select [OK].

2. Press the  button.

- The screen will return to the selection method screen.
- Selecting [Cancel] cancels the operation.



- Images are printed in order according to the file number.
- A maximum of 998 images can be selected.
- When the camera is connected to a printer, the  button will light blue. At this time, printing will begin after performing the following.
 - 1 Press the  button.
 - 2 Confirm that [Print] is selected, then press the **FUNC./SET** button.

Setting the DPOF Transfer Settings

You can use the camera to specify settings for images before downloading to a computer. Refer to the *Software Starter Guide* for instructions on how to transfer images to your computer. The settings used on the camera comply with the DPOF standards.





The  icon may display for a memory card with transfer settings set by a different DPOF-compliant camera. These settings will be overwritten by those set by your camera.

1 Select [Transfer Order].

1. Press the  button.
2. In the  menu, use the  or  button to select .
3. Press the  button.



2 Select an order method.

1. Use the  or  button to select an order method.
 - Order : Select single images.
 - Mark all : Select all the images on a memory card.
2. Press the  button.



- Selecting [Reset] cancels all transfer order settings.

Single Images

3 Select an image to transfer.

1. Use the **←** or **→** button to select an image to transfer.
2. Press the **FUNC./SET** button.
 - Pressing the **FUNC./SET** button again deselects the setting.
 - You can also select images in the index playback mode.
 - Press the **MENU** button to end the setting.

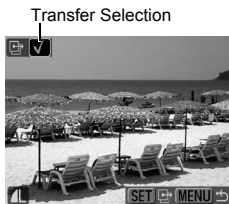

Mark all

3 Execute the transferring images.

1. Use the **←** or **→** button to select [OK].
2. Press the **FUNC./SET** button.
 - Press the **MENU** button to end the setting.



- Images are transferred in order according to the file number.
- A maximum of 998 images can be selected.

Configuring the Camera







Power Saving Function



This camera is equipped with a power saving function, which can automatically turn off the power or LCD monitor.



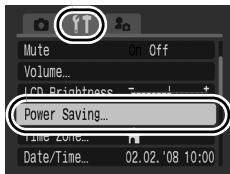

Auto Power Down	<p>When set to [On], the power will shut off in the following circumstances. Press the ON/OFF button again to restore power.</p> <p>Shooting mode: Approximately 3 minutes after the last control is accessed on the camera</p> <p>Playback mode or when connected to a printer: Approximately 5 minutes after the last control is accessed on the camera.</p>
Display Off	<p>In shooting mode, the LCD monitor automatically turns off after the selected time if no control is accessed, regardless of the [Auto Power Down] setting. Press any button other than the ON/OFF button or change the camera orientation to turn the LCD monitor back on.</p>

1 Select [Power Saving].

1. Press the  button.
2. Use the  or  button to select the  menu.
3. Use the  or  button to select [Power Saving].
4. Press the  button.



2 Make settings.

1. Use the  or  button to select an option.
2. Use the  or  button to make settings.
3. Press the  button.

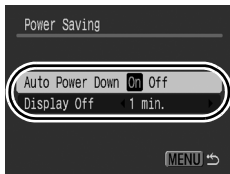

3 Press the button.



The power saving function will not activate during a slide show or while the camera is connected to a computer.







Setting the World Clock



When traveling abroad, you can record images with local dates and times simply by switching the time zone setting if you pre-register the destination time zones. You can enjoy the convenience of not having to switch the Date/Time settings.



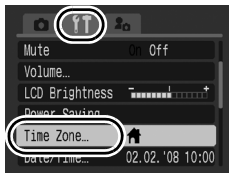

Setting the Home/World Time Zones

1 Select [Time Zone].

1. Press the  button.
2. Use the  or  button to select the  menu.
3. Use the  or  button to select [Time Zone].
4. Press the  button.



2 Select (Home).

1. Use the  or  button to select .
 2. Press the  button.
- When using for the first time, confirm that the screen to the right appears, then press the **FUNC./SET** button.



3 Select an area as home.

1. Use the ◀ or ▶ button to select a home time zone.

2. Press the  button.

- To set the daylight saving option, use the ▲ or ▼ button to display . The time will advance by 1 hour.

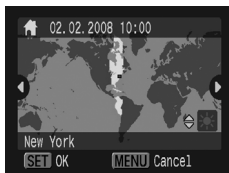

4 Select (World).

1. Use the ▼ button to select .

2. Press the  button.



5 Select a destination area.

1. Use the ◀ or ▶ button to select a destination time zone.

2. Press the  button.





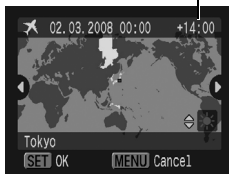

- As in Step 3, you can set daylight saving time.

Time Difference from
the Home Time Zone







Switching to the Destination Time Zone

1 Select [Time Zone].

1. Press the  button.
2. Use the  or  button to select the  menu.
3. Use the  or  button to select [Time Zone].
4. Press the  button.



2 Select (World).

1. Use the  or  button to select .
 2. Press the  button twice.
- To change the destination time zone, use the **FUNC./SET** button.
 - When you switch to the destination time zone,  will display on the LCD monitor.

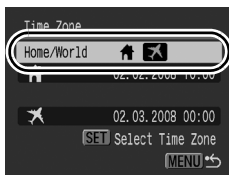

If you change the date and time when the World option is selected, the Home date and time will also change automatically.

Formatting Memory Cards









You should always format a new memory card or one from which you wish to erase all images and other data.







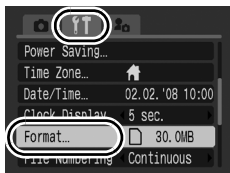

- Please note that formatting (initializing) a memory card erases all data, including protected images and other file types.
- When the  icon is displayed, sound data recorded with the sound recorder exists. Exercise adequate caution before formatting the memory card.

1 Select [Format].

1. Press the  button.
2. Use the  or  button to select the  menu.
3. Use the  or  button to select [Format].
4. Press the  button.



2 Make settings.

1. Use the  or  button to select [OK].
2. Press the  button.
 - To perform a low level format, use the  button to select [Low Level Format] and the  or  button to add a check mark.
 - You can stop formatting a memory card when [Low Level Format] is selected by pressing the **FUNC./SET** button. You can still use a memory card without problem when formatting is halted, but its data will be erased.

Displays when sound data recorded with the sound recorder is present ([p. 152](#))

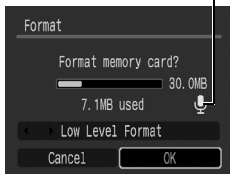



Low Level Format

We recommend you select [Low Level Format] when you think that the recording/reading speed of a memory card has dropped. A low level format may require 2 to 3 minutes with some memory cards.







Resetting the File Number



The images you shoot are automatically assigned file numbers. You can select how the file number is assigned.

Continuous	<p>A number one higher than the last one recorded is assigned to the next image. This is convenient for managing all your images together on a computer because you avoid file name duplication when changing folders or memory cards.*</p> <p>* When a blank memory card is used. If a memory card with recorded data is used, the 7-digit number for the last recorded folder and image is compared with the last one on the memory card, and the larger of the two is utilized as the basis for new images.</p>
Auto Reset	<p>The image and folder number are reset to the starting value (100-0001).* This is convenient for managing images on a folder-by-folder basis.</p> <p>* When a blank memory card is used. If a memory card with recorded data is used, the number following the 7-digit number for the last recorded folder and image on the memory card is utilized as the basis for new images.</p>

1 Select [File Numbering].

1. Press the  button.
2. Use the  or  button to select the  menu.
3. Use the  or  button to select [File Numbering].



2 Make settings.

1. Use the ◀ or ▶ button to select a file numbering setting.
2. Press the  button.

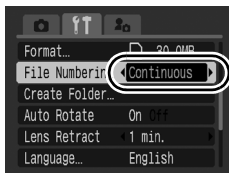

File and Folder Numbers

Recorded images are assigned consecutive file numbers starting with 0001 and ranging up to 9999, while folders are assigned numbers starting with 100 and ranging up to 999. Up to 2000 images can be saved into a single folder.

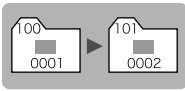
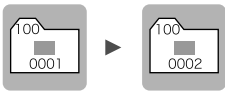
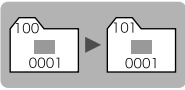
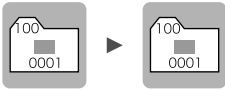
	New Folder Created	Memory Card Exchanged for Another
Continuous	Memory Card 1 	Memory Card 1 Memory Card 2 
Auto Reset	Memory Card 1 	Memory Card 1 Memory Card 2 

- Images may be saved to a new folder when there is insufficient free space even if the total number of images in a folder is less than 2000 because the following types of images are always saved together into the same folder.
 - Images from continuous shooting
 - Self-timer images (custom)
 - Stitch Assist mode images
 - Still images shot in Color Accent/Color Swap mode with the [Save Original] category set to [On].
- Images cannot be played back when the folder numbers are duplicated or image numbers are duplicated within folders.
- Please refer to the *Software Starter Guide* for information regarding folder structures or image types.

Creating an Image Destination (Folder)



You can create a new folder at any time and the recorded images will be automatically saved to that folder.

Create New Folder	Creates a new folder the next time you shoot images. To create an additional folder, insert the check mark again.
Auto Create	You can also specify a date and time if you wish to create a new folder using a shooting time after the specified date and time.

Creating a Folder the Next Time You Shoot

1 Select [Create Folder].

1. Press the button.
2. Use the or button to select the menu.
3. Use the or button to select [Create Folder].
4. Press the button.



2 Make settings.





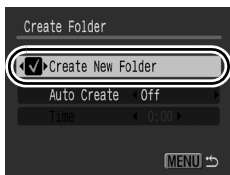

1. Use the or button to check mark [Create New Folder].
2. Press the button twice.

- will be displayed on the LCD monitor when shooting. The symbol will disappear from the screen when a new folder is created.











Setting the Day or Time for Automatic Folder Creation

1 Select [Create Folder].

1. Press the  button.
2. Use the  or  button to select the  menu.
3. Use the  or  button to select [Create Folder].
4. Press the  button.



2 Make settings.

1. Use the  or  button to select [Auto Create] and the  or  button to select a creation date.
2. Use the  or  button to select [Time] and the  or  button to select a time.
3. Press the  button twice.

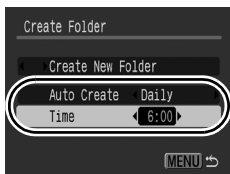

-  displays when the specified time arrives. The symbol will cease to display after the new folder is created.









Up to 2000 images can be saved into one folder. A new folder will automatically be created when you record more than that number even if you are not creating new folders.

Setting the Auto Rotate Function







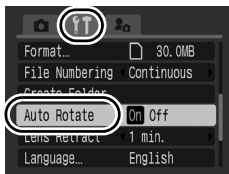

Your camera is equipped with an Intelligent Orientation sensor that detects the orientation of an image shot with the camera held vertically and automatically rotates it to the correct orientation when viewing it in the LCD monitor.

1 Select [Auto Rotate].

1. Press the  button.
2. Use the  or  button to select the  menu.
3. Use the  or  button to select [Auto Rotate].



2 Make settings.

1. Use the  or  button to select [On] or [Off].
2. Press the  button.
 - When the Auto Rotate function is set to [On] and the LCD monitor is set to the detailed display mode in the shooting mode,  (normal),  (right end is down) or  (left end is down) will appear in the display.



- This function may not operate correctly when the camera is pointed straight up or down. Check that the arrow  is pointing in the right direction and if it is not, then set the Auto Rotate function to [Off].
- Even if the Auto Rotate function is set to [On], the orientation of images downloaded to a computer will depend upon the software used to download the images.









When the camera is held vertically to shoot, the Intelligent Orientation sensor judges the upper end to be “up” and the lower end to be “down”. It then regulates the optimal white balance, exposure and focus for vertical photography. This function operates regardless of the on/off status of the Auto Rotate function.

Resetting Settings to Their Default Values





1 Select [Reset All].

1. Press the  button.
2. Use the  or  button to select the  menu.
3. Use the  or  button to select [Reset All].
4. Press the  button.



2 Make settings.

1. Use the  or  button to select [OK].
2. Press the  button.

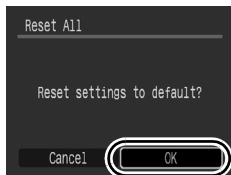



- Settings cannot be reset when the camera is connected to a computer or to a printer.
- The following cannot be reset.
 - The shooting mode.
 - The [Time Zone], [Date/Time], [Language] and [Video System] options in the **II** menu (p. 58)
 - White balance data recorded with the custom white balance function (p. 105)
 - Colors specified in the [Color Accent] (p. 109) or [Color Swap] (p. 111) modes
 - Newly added My Camera settings (p. 189)

Connecting to a TV

Shooting/Playback Using a TV



You can use the supplied AV cable to shoot or playback images using a TV.

1 Turn off the camera and the TV.

2 Connect the AV cable to the camera's A/V OUT and DIGITAL terminal.

- Slip your fingernail or the toggle on the wrist strap under the left edge of the terminal cover to open it and insert the AV cable all the way into the connector.

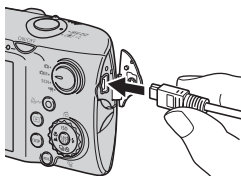

3 Plug the other ends of the AV cable to the VIDEO IN and AUDIO IN jacks on the TV.

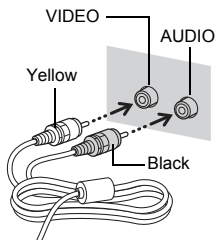

4 Turn on the TV and switch it to video mode.

5 Turn on the camera.



- The video output signal can be switched (NTSC or PAL) to accommodate different regional standards (p. 58). The default setting varies between regions.
 - NTSC: Japan, U.S.A., Canada, Taiwan and others
 - PAL: Europe, Asia (excluding Taiwan), Oceania and others
- If the video system is set incorrectly, the camera output may not display properly.

Customizing the Camera (My Camera Settings)







You can also use the control dial to select images and perform various operations. See [p. 43](#).

My Camera allows you to customize the start-up image and start-up, operation, self-timer and shutter sounds. You can change and register these settings, enabling you to customize the camera to suit your own tastes.

Changing My Camera Settings



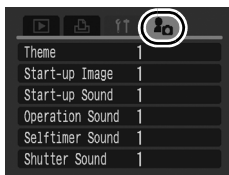

1 Select a menu item.

1. Press the  button.
2. Use the  or  button to select the  menu.
3. Use the  or  button to select menu item.



2 Make settings.

1. Use the  or  button to select contents you wish to set.
2. Press the  button.
 - Select [Theme] to set all to the same settings.

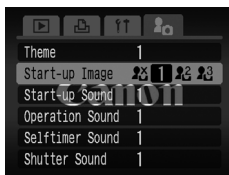

Registering My Camera Settings



Images recorded onto the memory card and newly recorded sounds can be added as My Camera settings to the and menu items. You can also use the supplied software to upload your computer's images and sounds to the camera.



A computer is required to restore the My Camera settings to the defaults. Use the supplied software (ZoomBrowser EX/ImageBrowser) to restore the default settings to the camera.

1 Select a menu item.

1. Press the button.
2. Use the or button to select the menu.
3. Use the or button to select menu item to register.

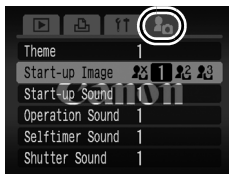

2 Select a setting.

1. Use the or button to select or .
2. Press the button.

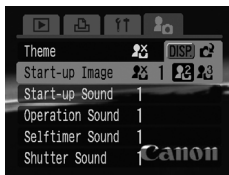







3 Make settings.

[Start-up Image]

1. Use the or button to select image to register.
2. Press the button.



[Start-up Sound]/[Operation Sound]/ [Selftimer Sound]/[Shutter Sound]

1. Use the ◀ or ▶ button to select  (Record).
2. Press the  button.
3. After recording, use the ◀ or ▶ button to select  (Register).
4. Press the  button.
 - Recording will automatically stop when the recording time elapses.
 - To play it, select  (Play).
 - To exit instead of registering, select  (Exit).

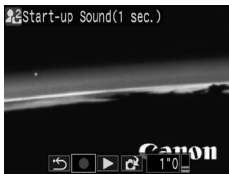

4 Register the setting.

1. Use the ◀ or ▶ button to select [OK].
2. Press the  button.
 - To cancel registering, select [Cancel].



- The following cannot be registered as My Camera settings.
 - Movies
 - Sounds recorded with the sound memo function (p. 151)
 - Sounds recorded with the Sound Recorder (p. 152)
- The prior setting is erased when a new My Camera setting is added.



See the supplied *Software Starter Guide* for more information on creating and adding to the My Camera data.

Troubleshooting

- Camera (p. 191)
- When the power is turned on (p. 192)
- LCD monitor (p. 192)
- Shooting (p. 194)
- Shooting movies (p. 198)
- Playback (p. 199)
- Battery/Battery Charger (p. 199)
- TV monitor output (p. 200)
- Printing with a direct print compatible printer (p. 200)

Camera

Camera will not operate.

Power is not turned on.	<ul style="list-style-type: none"> ● Press the ON/OFF button (p. 42).
Memory card slot/battery cover is open.	<ul style="list-style-type: none"> ● Confirm that the Memory card slot/ battery cover is securely closed (p. 11).
Battery charge insufficient to operate camera ("Change the battery pack" message displays).	<ul style="list-style-type: none"> ● Insert a fully charged battery into the camera (p. 10). ● Use the AC Adapter Kit ACK-DC30 (sold separately) (pp. 36, 214).
Poor contact between camera and battery terminals.	<ul style="list-style-type: none"> ● Polish the terminals with a soft cotton swab before charging or using the battery (p. 207).

Sounds come from the camera interior.

The camera's horizontal/ vertical orientation was changed.	<ul style="list-style-type: none"> ● The camera's orientation mechanism is operating. There is no malfunction.
--	---

When the power is turned on

“Card locked!” message appears.

The SD memory card's or SDHC memory card's write protect tab is set to “Write protect”.

- When recording to, erasing from or formatting the memory card, slide the write protect tab upward (p. 212).

The Date/Time menu appears.

The built-in rechargeable lithium battery charge is low.

- Recharge the built-in battery immediately (p. 15).

LCD monitor

Nothing displays.

The LCD monitor is set not to display.

- Press the **DISP.** button to turn on the LCD monitor (p. 60).

[Power Saving] is set to [Display Off].

- Press any button other than the ON/OFF button or change the camera orientation to turn the LCD monitor back on (p. 174).

The LCD monitor will shut off during shooting.

If [Power Saving] is set to [Display Off], the power saving function will shut down the LCD monitor while shooting in  mode.

Camera screen is black at start-up.

Incompatible image has been selected as the startup image in the My Camera settings.

- Change the start-up image in the My Camera settings (p. 188) or use the supplied software program ZoomBrowser EX or ImageBrowser to restore the default settings.

The display darkens.

The image in the LCD monitor will darken in strong sunlight or bright light.

- This is a normal occurrence in devices containing CCDs and does not constitute a malfunction. This image will not be recorded when shooting still photos, but it will be recorded when shooting movies.

Display flickers.

Display flickers when shot under fluorescent lighting.

- This is not a camera malfunction (flickering recorded in movies, but not in still images).

A bar of light (purplish red) appears on the LCD monitor.

Sometimes appears when shooting a bright subject, such as the sun or other light source.

- This is a normal occurrence in devices containing CCDs and does not constitute a malfunction. (This bar of light will not be recorded when shooting still photos, but it will be recorded when shooting movies.)

appears.

A slow shutter speed has likely been selected because of insufficient lighting.

- Set the IS Mode to any setting other than [Off] (p. 72).
- Raise the ISO speed (p. 74).
- Set the flash to any setting other than  (flash off) (p. 66).
- Set the self-timer and secure the camera to something, such as a tripod.

appears.

This displays when using a memory card that has print settings, transfer settings or slide show image settings set by other DPOF-compliant cameras.

- These settings will be overwritten by those set by your camera (pp. 136, 165, 172).

Noise displays./Subject's movements are irregular.

Camera automatically lightened the image displayed on the LCD monitor to make it easier to see when shooting in a dark area (p. 61).

- There is no effect on the recorded image.

Shooting

Camera will not record.

Camera is in playback mode.

- Switch to Shooting mode (p. 44).

Camera is connected to computer or printer.

- Disconnect the interface cable, and switch to a shooting mode.

Flash is charging.

- When the flash is charged, the indicator will light orange. Shooting is now possible (p. 46).

Memory card is full.

- Insert a new memory card (p. 11).
- If required, download the images to a computer and erase them from the memory card to make space.

Memory card is not formatted correctly.

- Format the memory card (p. 178).
- If reformatting does not work, the memory card logic circuits may be damaged. Consult the nearest Canon Customer Support Help Desk.

SD memory card or SDHC memory card is write protected.

- Slide the write protect tab upward (p. 212).

Image Seen in Viewfinder vs. Recorded Image.

Usually the recorded image contains more of the scene than is seen in the viewfinder.

- Confirm the actual image size with the LCD monitor. Use the LCD monitor when taking close-up shots (p. 60).

Image is blurred or out of focus.

The camera moves when the shutter button is pressed.

- Confirm the procedures in “ appears” (p. 193).

AF-assist Beam is set to [Off].

- In dark places where it is difficult for the camera to focus, the AF-assist Beam will emit to assist focusing. As the AF-assist Beam will not function when turned off, set it [On] to activate it (p. 55). Take care not to obstruct the AF-assist Beam with your hand when used.

Subject is out of focal range.

- Shoot with the subject at the correct focusing distance (p. 218).
- The camera may be set to an unintended function (such as macro). Cancel the setting.

The subject is hard to focus on.

- Use the focus lock or AF lock to shoot (p. 97).

Subject in recorded image is too dark.

Insufficient light for shooting.

- Set the built-in flash to  (Flash on) (p. 66).

The subject is underexposed because the surroundings are too bright.

- Set the exposure compensation to a positive (+) setting (p. 101).
- Use the AE lock or spot metering function (pp. 99, 102).

Subject is too far away for flash to reach.

- Shoot within correct flash range of the subject when using the built-in flash (p. 219).
- Raise the ISO speed and then shoot (p. 74).

Subject in recorded image is too bright, or image flashes white.











Subject is too close, making the flash too strong.	<ul style="list-style-type: none"> ● Shoot within correct flash range of the subject when using the built-in flash (p. 219).
The subject is overexposed because the surroundings are too dark.	<ul style="list-style-type: none"> ● Set the exposure compensation to a negative (–) setting (p. 101). ● Use the AE lock or spot metering function (pp. 99, 102).
Too much light is shining directly into the camera, or is being reflected off the subject.	<ul style="list-style-type: none"> ● Change the shooting angle.
Flash is set to  (Flash on).	<ul style="list-style-type: none"> ● Set the flash to  (Flash off) (p. 66).

Image contains noise.

ISO speed is too high.	<ul style="list-style-type: none"> ● Higher ISO speeds and  (High ISO Auto) setting may increase image noise. For higher image quality, use as low an ISO speed as possible (p. 74). ● In , , , , ,  and  mode, the ISO speed increases and noise can appear.
------------------------	---

White dots appear on the image.

Light from the flash has reflected off dust particles or insects in the air. This is particularly noticeable when shooting using the wide angle.	<ul style="list-style-type: none"> ● This is a phenomenon that occurs with digital cameras and does not constitute a malfunction.
--	--

Eyes appear red.

Light is reflected back from the eyes when the flash is used in dark areas.

- Shoot with [Red-Eye Lamp] in the [Flash Settings] menu set to [On] (p. 80). For this mode to be effective, the subject must be looking right at the red-eye reduction lamp. Try asking them to look directly at the lamp. Even better results can be obtained by increasing the lighting in indoor settings or approaching closer to the subject. The shutter will not activate for approximately 1 second after the red-eye reduction lamp fires in order to improve the effect.
- If you set the [Red Eye Corr.] in the [Flash Settings] to [On], the camera will automatically correct red eyes while shooting and record the image to the card (p. 80).
- You can correct red eyes in recorded images using the [Red-Eye Correction] in the Playback menu (p. 142).

Continuous shooting slows down.

The memory card's performance has dropped.

- To enhance the continuous shooting performance, you are recommended to low level format the memory card in the camera after you save all its images to your computer (p. 178).

Recording images to memory card takes a long time.

Memory card was formatted in another device.

- Use a memory card formatted in your camera (p. 178).

Lens will not retract.

Memory card slot/battery cover was opened with power on.

- After closing the memory card slot/battery cover, turn the power on then back off.

Shooting movies

The recording time may not display properly or shooting may stop unexpectedly.

The following types of memory cards are used.

- Slow recording cards.
- Cards formatted on a different camera or a computer.
- Cards which have had images recorded and erased repeatedly.

- Although the recording time may not display properly during shooting, the movie will be recorded correctly on the memory card. Recording time will display properly if you format the memory card in this camera (excluding slow recording memory cards) (p. 178).

“!” displayed on the LCD monitor in red and shooting automatically stopped.

There is insufficient free space in the camera's built-in memory.

- Try the following procedures.
 - Format the card with a low level format before filming (p. 178).
 - Lower the recording pixels or frame rate (p. 86).
 - Use a high-speed memory card (SDC-512MSH, etc.).

Zoom does not operate.

Zoom lever was pressed while shooting in movie mode.

- Operate the zoom before shooting in movie mode (p. 62). Note the digital zoom is available while shooting (only in Standard movie mode) (p. 62).

Playback

Cannot play back.

You attempted to play back images shot with another camera or images edited with a computer.

- Computer images that cannot be played back may play back if they are added to the camera using the supplied software program ZoomBrowser EX or ImageBrowser.

File name was changed with a computer or file location was changed.

- Set the file name or location on the file format/structure of the camera (Refer to the *Software Starter Guide* for details).

Images cannot be edited.

Some images shot with another camera cannot be edited.

Movies do not play back correctly.

Movies recorded with high recording pixels may momentarily stop playing if played on slow reading memory cards.

You may experience frame dropping and audio breakup when playing back a movie on a computer with insufficient system resources.

Movies shot with this camera may not play back correctly on another camera.

Reading images from memory card is slow.

Memory card was formatted in another device.

- Use a memory card formatted in your camera ([p. 178](#)).

Battery

Battery consumed quickly.

Battery is not being used to its full capacity.

- See *Battery* ([p. 210](#)).

Battery life exceeded if battery loses its charge quickly at normal temperature (23 °C/73 °F).

- Replace the battery with a new one (p. 11).

Battery will not charge.

Battery life exceeded.

- Replace the battery with a new one (p. 11).

TV monitor output

Image is distorted or not showing on TV monitor.

Incorrect video system setting.

- Set the video system to the appropriate setting, NTSC or PAL, for your TV (p. 58).

Shooting in Stitch Assist mode.

- The output will not appear on a TV in Stitch Assist mode. Shoot in a different shooting mode (p. 45).

Printing with a direct print compatible printer

Cannot print

The camera and printer are not properly connected.

- Securely connect the camera and printer with the specified cable.

The printer power is not turned on.

- Turn on the printer power.

The print connection method is not correct.

- Select [Print Method] and select [Auto] (p. 58).

List of Messages

The following messages may appear on the LCD monitor during shooting or playback. Please refer to the *Direct Print User Guide* for the messages that display during a printer connection.

Busy...

Image is being recorded onto the memory card, red eye correction is being processed. Resetting all the camera and menu settings to default.

No memory card

You turned on the camera without a memory card installed, or with a memory card installed in the wrong orientation (p. 11).

Card locked!

The SD memory card or SDHC memory card is write protected (p. 212).

Cannot record!

You attempted to shoot an image without a memory card installed, with a memory card installed in the wrong orientation, or attempted to attach a sound memo to a movie.

Memory card error

The memory card may be malfunctioning. By formatting the malfunctioning memory card with the camera, you may be able to continue using it (p. 178). However, if this error message appears even when using the supplied memory card, contact your Canon Customer Support Help Desk as there may be a problem with the camera.

Memory card full

Memory card is full of images and no more can be recorded or saved. In addition, no more image settings, or sounds or sound memos can be recorded.

Naming error!

The file name could not be created because there is an image with the same name as the folder that the camera is attempting to create, or the highest possible file number has already been reached. In the Set up menu, set [File Numbering] to [Auto Reset]; alternatively, save all the images you wish to retain onto a computer, then reformat the memory card. Please note that formatting will erase all the existing images and other data.

Change the battery pack.

Battery charge is insufficient to operate the camera. Replace it at once with a charged one or recharge the battery. Also refer to *Battery* (p. 210).

No image.

No images recorded on memory card.

Image too large.

You attempted to play back an image larger than 5616 × 3744 pixels or with a large data size.

Incompatible JPEG

You attempted to play back an incompatible JPEG image (edited with a computer, etc.).

RAW

You attempted to play back a different type of RAW image.

Unidentified Image

You attempted to play back an image with corrupted data, an image with a recording type specific to another manufacturer's camera, or an image that has been downloaded to a computer and altered.

Cannot magnify!

You attempted to magnify an image recorded in a different camera or data type, an image edited with a computer, or a movie.

Cannot rotate

You attempted to rotate the image shot with a different camera or data type, or an image edited with a computer.

Incompatible WAVE

A sound memo cannot be added to this image since the data type of the existing sound memo is incorrect. In addition, sound cannot be played back.

Cannot register this image!

You attempted to register an image recorded in a different camera or a movie as a start-up image.

Cannot modify image

You attempted to resize or perform red eye correction on a movie or an image recorded with another camera. Or you attempted to resize an image already resized to **XS** or an image shot in **W**. Or, you attempted to trim an image recorded using **W**, or a **S** or **XS** image.

Cannot assign to category

You attempted to categorize an image recorded in a different camera.

Cannot Modify

Cannot apply red-eye correction as no red-eye is detected.

Cannot transfer!

When transferring images to your computer using the Direct Transfer menu, you attempted to select a RAW image, an image with corrupted data, an image taken with a different camera or data type. You may have also attempted to select a movie when [Wallpaper] was selected in the Direct Transfer menu.

Protected!

You attempted to erase or edit a protected image, movie or sound memo.

Too many marks

Too many images have been marked with print settings or transfer settings. Cannot process any more.

Cannot complete!

Could not save a part of the print or transfer settings.

Unselectable image

You attempted to set the print settings for a non-JPEG image.

Cannot select

In selecting the image range for categorizing via the My Category function, protecting images, erasing images or specifying print settings, you selected a starting image with a file number higher than the last image or a last image with a file number lower than the starting image. Or, you specified more than 500 images.

Communication error

The computer was unable to download the image due to the large amount of images (approx. 1000) stored on the memory card. Use a USB card reader or a PCMCIA card adapter to download the images.

Lens error, restart camera

An error was detected while the lens was in motion, and the power has been automatically turned off. This error can occur if you hold the lens while it is in motion or you operate it in a location with excessive dust or sand in the air. Try turning the power back on, and resume shooting or playback. If this message continues to display, contact your Canon Customer Support Help Desk as there may be a problem with the lens.

Exx

(xx: number) Camera detected an error. Turn the power off and then back on, then shoot or play back. A problem exists if the error code reappears. Note the number and contact your Canon Customer Support Help Desk. If an error code displays directly after taking a picture, the shot may not have been recorded. Check image in playback mode.

Appendix

Safety Precautions

- Before using the camera, please ensure that you read the safety precautions described below and in the “Safety Precautions” section. Always ensure that the camera is operated correctly.
- The safety precautions noted on the following pages are intended to instruct you in the safe and correct operation of the camera and its accessories to prevent injuries or damage to yourself, other persons and equipment.
- Equipment refers to the camera, battery charger or compact power adapter (sold separately).
- Battery refers to the battery pack.

Warnings

Equipment

- **Do not point the camera at bright light sources (the sun in bright clear skies, etc.).**
 - Doing so could damage the camera's CCD.
 - Doing so can damage your eyesight.
- **Store this equipment out of the reach of children and infants.**
 - Wrist strap: Placement of the strap around the child's neck could result in asphyxiation.
 - Memory card: It may be swallowed accidentally. If this occurs, contact a doctor immediately.

-
- **Do not attempt to disassemble or alter any part of the equipment that is not expressly described in this guide.**
 - **To avoid the risk of high-voltage electrical shock, do not touch the flash portion of the camera if it has been damaged.**
 - **Stop operating the equipment immediately if it emits smoke or noxious fumes.**
 - **Do not allow the equipment to come into contact with, or become immersed in, water or other liquids. If the exterior comes into contact with liquids or salt air, wipe it dry with a soft, absorbent cloth.**

Continued use of the equipment may result in fire or electrical shock. Immediately turn the camera power off and remove the camera battery or unplug the battery charger or compact power adapter from the power outlet. Please consult your camera distributor or the closest Canon Customer Support Help Desk.

-
- **Do not use substances containing alcohol, benzene, thinners or other flammable substances to clean or maintain the equipment.**
 - **Do not cut, damage, alter or place heavy items on the power cord.**
 - **Use only recommended power accessories.**
 - **Remove the power cord on a regular periodic basis and wipe away the dust and dirt that collects on the plug, the exterior of the power outlet and the surrounding area.**
 - **Do not handle the power cord if your hands are wet.**

Continued use of the equipment may result in fire or electrical shock.

Battery

- **Do not place the battery near a heat source or expose it to direct flame or heat.**
- **The battery should not be immersed in water or sea water.**
- **Do not attempt to disassemble, alter or apply heat to the battery.**
- **Avoid dropping or subjecting the battery to severe impacts that could damage the casing.**
- **Use only recommended battery and accessories.**

Failure to follow these precautions may cause explosions or leaks, resulting in fire, injury and damage to the surroundings. In the event that a battery leaks and the eyes, mouth, skin or clothing contact these substances, immediately flush with water and seek medical assistance.

- **Disconnect the battery charger and compact power adapter from both the camera and the power outlet after recharging or when not in use to avoid fire and other hazards.**
- **Do not place anything, such as tablecloths, carpets, bedding or cushions, on top of the battery charger while it is charging.**

Leaving the units plugged in for a long period of time may cause them to overheat and distort, resulting in fire.

- **Use only the specified battery charger to charge the battery.**
- **The battery charger and compact power adapter are designed for exclusive use with your camera. Do not use it with other products or batteries.**

There is a risk of overheating and distortion which could result in fire or electrical shock.

- **Before you discard a battery, cover the terminals with tape or other insulators to prevent direct contact with other objects.**

Contact with the metallic components of other materials in waste containers may lead to fire or explosions.

Others

- **Do not trigger the flash in close proximity to human or animal eyes. Exposure to the intense light produced by the flash may damage eyesight.**

In particular, remain at least one meter (39 inches) away from infants when using the flash.

- **Keep objects that are sensitive to magnetic fields (such as credit cards) away from the speaker of the camera.**

Such items may lose data or stop working.

Cautions

Equipment

- **Do not sit with the camera in your back pocket.**

Doing so may cause malfunction or damage the LCD monitor.

- **Be careful not to bang the camera or subject it to strong impacts or shocks that could lead to injury or damage the equipment when wearing or holding it by the strap.**

- **Be careful not to bump or strongly push the end of the lens.**

The above-mentioned could lead to injury or damage the equipment.

- **Be careful not to allow dust or sand into the camera when using it at a beach or place with strong winds.**

Such conditions could lead to damage.

- **Do not store the equipment in humid or dusty areas.**

- **During shooting, do not allow metal objects (such as pins or keys) or dirt to contact the charger terminals or plug.**

Such conditions could lead to fire, electrical shock or other damage.

- **Avoid using, placing or storing the equipment in places subject to strong sunlight or high temperatures, such as the dashboard or trunk (boot) of a car.**
- **Do not use the equipment in a manner that exceeds the rated capacity of the electrical outlet or wiring accessories. Also, do not use the equipment if the cable or plug is damaged, or if the plug is not fully inserted into the power outlet.**
- **Do not use in locations with poor ventilation.**

The above-mentioned can cause leakage, overheating or explosion, resulting in fire, burns or other injuries. High temperatures may also cause deformation of the casing.

- **When not using the camera for extended periods of time, remove the battery from the camera or battery charger and store the equipment in a safe place.**

If the battery is left inside the camera, damage caused by leakage may occur.

- **Do not connect compact power adapters or battery chargers to devices such as electrical transformers for foreign travel because it may lead to malfunctions, excessive heat generation, fire, electric shock or injury.**

Flash

- **Do not operate the flash with dirt, dust or other items stuck to the surface of the flash.**
- **Be careful not to cover the flash with your fingers or clothing when shooting.**

The flash may be damaged and emit smoke or noise. The resulting heat build-up could damage the flash.

- **Do not touch the surface of the flash after taking several pictures in rapid succession.**

Doing so could result in burns.

Preventing Malfunctions

Camera

Avoid Strong Magnetic Fields

- **Never place the camera in close proximity to electric motors or other equipment generating strong electromagnetic fields.**

Exposure to strong magnetic fields may cause malfunctions or corrupt image data.

Avoid Condensation Related Problems

- **When moving the equipment rapidly from cold to hot temperatures, you can avoid condensation by placing the equipment in an airtight, resealable plastic bag and letting it adjust to temperature changes slowly before removing it from the bag.**

If condensation forms on the camera, remove the memory card and battery, and set the camera aside in room temperature to allow the condensation to naturally evaporate before using the camera again.

Battery

- **Keep the battery terminals clean at all times.**

Dirty terminals may cause poor contact between the battery and camera. Polish the terminals with a soft cotton swab before charging or using the battery.

- **At low temperatures, battery performance may be reduced and the low battery icon  (blinks red) may appear earlier than usual.**

Under these conditions, restore the battery performance by warming it in a pocket immediately before use.

- **Do not put the battery into a pocket together with metallic items such as a key ring.**

The battery may be short circuiting.

- Do not allow any metal objects such as key rings to touch the (+) and (−) terminals (Fig. A). To carry the battery or store it during periods of disuse, always replace the terminal cover (Fig. B).

These conditions can damage the battery. You may be able to check the charge state depending upon how the terminal cover is attached (Fig. C, D).

Fig. A



Fig. B

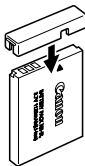
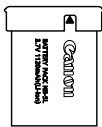

Fig. C

Fully Charged Battery



Attach it so the ▲ is visible

Fig. D

Used Battery



Attach in the opposite way of Fig. C.

- You are recommended to use it in the camera until it is depleted and to store it in an indoor location with low relative humidity and between the temperatures of 0 – 30 °C (32 – 86 °F).

Storing a fully charged battery for long periods of time (about one year) may shorten its life cycle or affect its performance. If you do not use the battery for long periods of time, charge it fully and discharge it in the camera about once a year before returning it to storage.

- Since this is a lithium-ion battery, you need not deplete it before recharging.
- You are advised to charge the battery on the day of use, or one day before, to ensure a full charge.

Even charged batteries continue to discharge naturally.

- It takes approximately 2 hours 5 minutes to fully charge the battery from a depleted state (based on Canon's testing standards).
- Charging it within a temperature range of 5 – 40 °C (41 – 104 °F) is recommended.
- Charge times may vary according to the ambient temperature and the battery's charge state.

- If the performance of the battery diminishes substantially even when it is fully charged, its life has been exceeded and it should be replaced.

Memory Card

- **SD Memory Card or SDHC Memory Card Write Protect Tab**

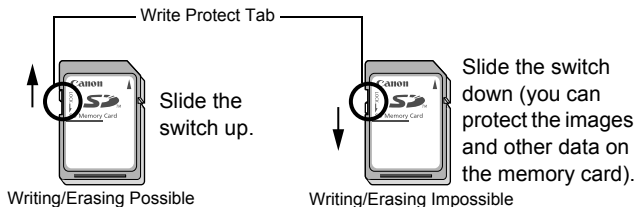

- **Memory cards are high-precision electronic devices. Do not bend them, apply force to them, or subject them to shocks or vibration.**
- **Do not attempt to disassemble or alter the memory card.**
- **Do not allow dirt, water or foreign objects to contact the terminals on the back of the memory card. Do not touch the terminals with your hands or metal objects.**
- **Do not peel away the original label on the memory card or cover it with another label or sticker.**
- **When writing on the memory card, do not use a pencil or ballpoint pen. Only use a soft point pen (e.g. felt-tip pen).**
- **Do not use or store memory cards in the following locations.**
 - Locations subject to dust or sand
 - Locations subject to high humidity and high temperatures
- **Since some or all of the data recorded on the memory card may be corrupted or erased by electrical noise, static electricity, camera or memory card malfunction, making a backup copy of important data is recommended.**
- **Please note that formatting (initializing) an memory card erases all data, including protected images.**

-
- **You are recommended to use memory cards that have been formatted in your camera.**
 - The memory card supplied with the camera may be used without further formatting.
 - When the camera is malfunctioning, a corrupted memory card might be the cause. Reformatting the memory card may solve the problem.
 - When a non-Canon brand memory card is malfunctioning, reformatting it may solve the problem.
 - Memory cards formatted in other cameras, computers, or peripheral devices may not operate correctly in this camera. When that happens, reformat the memory card with this camera.
-
- **If formatting in the camera does not work properly, turn the camera off and re-insert the memory card. Then turn the camera back on and format again.**
-
- **Be careful when transferring or disposing of a memory card. Formatting or erasing the data on a memory card merely changes the file management information on the memory card and does not ensure that its contents are completely deleted. When disposing of a memory card, take precautions, such as physically destroying the memory card, to prevent personal information leaks.**
-

Using the AC Adapter (Sold Separately)

It is best to power the camera with AC Adapter Kit ACK-DC30 (sold separately) when you are using it for long periods of time or connecting it to a computer.



Turn the camera power off before connecting or disconnecting the AC adapter.

- 1 Connect the power cord to the compact power adapter first and then plug the other end into the power outlet.**

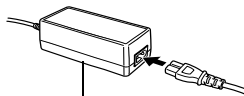

Compact Power Adapter
CA-DC10

- 2 Open the memory card slot/battery cover, push the battery lock in the direction of the arrow and insert the DC coupler until it locks.**

- Slide the memory card slot/battery cover closed.

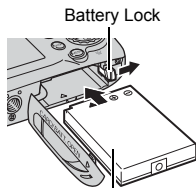

DC Coupler DR-30

- 3 Open the DC coupler terminal cover and attach the cord to the DC terminal.**

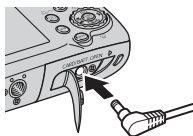

Using an Externally Mounted Flash (Sold Separately)

High-Power Flash HF-DC1

This flash is used to supplement the camera's built-in flash when the subject is too far away for proper illumination. Use the following procedures to affix the camera and High-Power Flash to the supporting bracket.

Please read the instructions accompanying the flash along with this explanation.

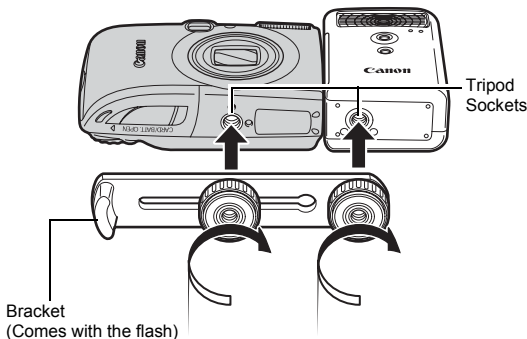

- The flash charge time will lengthen as the battery charge gets weaker. Always set the power/mode switch to off when you finish using the flash.
- Be careful not to touch the flash window or sensor windows with your fingers while the flash is in use.
- The flash may fire if another flash is being used in close proximity.
- The High-Power Flash may not fire outdoors in daylight or when there are no reflective items.
- For continuous shooting, although the flash fires for the first shot, it does not fire for subsequent shots.

- Fasten the attachment screws securely so that they do not loosen. Failure to do so may lead to the dropping of the camera and flash resulting in damage to both.



- Before attaching the bracket to the flash, check that the lithium battery (CR123A or DL123) is installed.
- To illuminate the subjects properly, install the flash so that it is up against the side of the camera and parallel with the camera's front panel.
- A tripod can be used even when the flash is attached.

Batteries

- Charge becomes Severely Limited

If the battery usage time has considerably diminished, wipe the battery terminals well with a dry cloth. The terminals may be dirty from fingerprints.

- Usage in Cold Temperatures

Get a spare generic lithium battery (CR123A or DL123). You are recommended to place the spare battery in your pocket to warm it up before switching it for the battery in the flash.

- Non-Use over Extended Periods

Leaving batteries in the High-Power Flash could allow the battery fluid to leak, damaging the product. Remove the batteries from the High-Power Flash and store them in a cool, dry place.

Camera Care and Maintenance



Never use thinners, benzine, detergents or water to clean the camera. These substances may distort or damage the equipment.

Camera Body

Gently wipe dirt off the camera body with a soft cloth or eyeglass lens wiper.

Lens

First use a lens blower brush to remove dust and dirt, then remove any remaining dirt by wiping the lens lightly with a soft cloth.



Never use organic solvents on the camera body or lens. If dirt remains, contact the closest Canon Customer Support Help Desk as listed in the European Warranty System (EWS) Booklet.

Viewfinder and LCD Monitor

Use a lens blower brush to remove dust and dirt. If necessary, gently wipe with a soft cloth or an eyeglass lens wiper to remove stubborn dirt.



Never rub or press strongly on the LCD monitor. These actions may damage it or lead to other problems.

Specifications

All data is based on Canon's standard testing methods. Subject to change without notice.

DIGITAL IXUS 970 IS (W): Max. wide angle (T): Max. telephoto

Camera Effective Pixels	: Approx. 10.0 million
Image Sensor	: 1/2.3-inch type CCD (Total number of pixels: Approx. 10.3 million pixels)
Lens	: 6.6 (W) – 33.0 (T) mm (35mm film equivalent: 37 (W) – 185 (T) mm) f/3.2 (W) – f/5.7 (T)
Digital Zoom	: Approx. 4.0x (Up to approx. 20x in combination with the optical zoom)
Optical Viewfinder	: Real-image zoom viewfinder
LCD Monitor	: 2.5-inch type, low-temperature polycrystalline silicon TFT color LCD (Pure Color LCD II), approx. 230,000 dots, picture coverage 100%
AF System	: TTL autofocus AF frame mode: Face Detect ^{*1*2/} AiAF (9-points)/Center ^{*3} ^{*1} AF frame can be moved and fixed to specified face. ^{*2} If no face is detected, AiAF (9-points) is used. ^{*3} Normal or small sizes can be selected.
Focusing Range (From the front of the lens)	: Normal: 50 cm (1.6 ft.) – infinity Macro: 2 – 50 cm (W) (0.79 in. – 1.6 ft. (W)) Infinity: 3 m (9.8 in.) – infinity Kids&Pets: 1 m (3.3 ft.) – infinity (W/T)
Shutter	: Mechanical shutter and electronic shutter
Shutter Speeds	: 1/60 – 1/1600 sec. 15 – 1/1600 sec. (Total shutter speed range. Available range varies by shooting mode.) • Slow shutter speeds of 1.3 sec. or slower operate with noise reduction.

Image Stabilization	: Lens-shift type Continuous/Shoot Only*/Panning*/Off * Still images only.
Metering System	: Evaluative* ¹ /Center-weighted average or Spot* ² * ¹ Facial brightness is also evaluated in Face Detect AF. * ² Fixed to center.
Exposure Compensation	: ±2 stops in 1/3-stop increments
ISO Speed (Standard Output Sensitivity, Recommended Exposure Index)	: Auto* ¹ , High ISO Auto* ² , ISO 80/100/200/400/ 800/1600 * ¹ Camera automatically sets the optimal speed according to shooting mode and subject brightness. * ² Camera automatically sets the optimal speed according to shooting mode, subject brightness and subject movement. However, the ISO speed is set relatively higher than Auto.
White Balance	: Auto*, Day Light, Cloudy, Tungsten, Fluorescent, Fluorescent H or Custom * The colors of faces are evaluated in Face Detect AF.
Built-in Flash	: Auto*, on*, off * Facial brightness is also evaluated in Face Detect AF.
Built-in Flash Range	: 30 cm – 3.5 m (12 in. – 11 ft.) (W)/ 30 cm – 2.0 m (12 in. – 6.6 ft.) (T) • Brightness of image periphery may reduce depending on shooting distance.
Shooting Modes	: Auto, Manual, Digital macro, Color Accent, Color Swap, Stitch Assist, SCN* ¹ , Movie* ² * ¹ Portrait, Night Snapshot, Kids&Pets, Indoor, Sunset, Foliage, Snow, Beach, Fireworks, Aquarium, ISO 3200. * ² Standard, Compact, Color Accent, Color Swap, Time Lapse.
Continuous Shooting	: Approx. 1.2 shots/sec.
Self-timer	: Approx. 10-sec./approx. 2-sec. delay or custom
Recording Media	: SD memory card/SDHC memory card/ MultiMediaCard/MMCplus card/HC MMCplus card
File Format	: Design rule for camera file system and DPOF compliant

Data Type	: Still images: Exif 2.2 (JPEG)* : Movies: AVI (Image data: Motion JPEG; Audio data: WAVE (monaural)) : Sound Memo or Sound Recorder: WAVE (monaural) * This digital camera supports Exif 2.2 (also called "Exif Print"). Exif Print is a standard for enhancing the communication between digital cameras and printers. By connecting to an Exif Print-compliant printer, the camera's image data at the time of shooting is used and optimized, yielding extremely high quality prints.
Compression	: Superfine, Fine, Normal
Number of (Still images)	: Large : 3648 × 2736 pixels
Recording	Medium 1 : 2816 × 2112 pixels
Pixels	Medium 2 : 2272 × 1704 pixels
	Medium 3 : 1600 × 1200 pixels
	Small : 640 × 480 pixels
	Date Stamp : 1600 × 1200 pixels
	Widescreen : 3648 × 2048 pixels
(Movies)	: Standard, Color Accent, Color Swap : 640 × 480 pixels (30 frames/sec.) : 640 × 480 pixels (30 frames/sec. LP) : 320 × 240 pixels (30 frames/sec.) Recording can continue until the memory card is full* ¹ (can record up to a maximum of 4 GB at one time* ²) : Compact: 160 × 120 pixels (15 frames/sec.) Maximum recording length per clip: 3 min. : Time Lapse : 640 × 480 pixels (1 frame/sec. (shooting interval: 1 sec.), 0.5 frame/sec. (shooting interval: 2 sec.)) (15 frames/sec. (during playback)) Maximum recording length per clip: 2 hours * ¹ Using super high-speed memory cards (SDC-512 MSH recommended). * ² Even if the file size has not reached 4 GB, the recording is stopped when the recording time reaches one hour. Depending on memory card capacity and data write speed, recording may stop before the file size reaches 4 GB or the recording time reaches one hour.

Sound Memo	: Bit Rate: 16 bits Sampling Rate Sound memo, movie (Compact): 11.025 kHz Movie (other than Compact): 44.100 kHz Sound Recorder: 11.025 kHz/22.050 kHz/ 44.100 kHz
Playback Modes	: Single (histogram displayable), Index (9 images), Magnified (approx. 2x to 10x max.), Resume Playback, Image Inspection Tool, Jump, My Category, Movie Playback (slow motion available), Rotate, Slide Show, Red-Eye Correction, Trimming, Resize, My Colors, Sound (recording/playback up to 1 min.), Sound Recorder (up to 2 hours sound-only recording/playback possible) or Protect.
Direct Print	: PictBridge compliant, and Canon Direct Print and Bubble Jet Direct compatible
My Camera Settings	: Start-up image, start-up sound, operation sound, self-timer sound, and shutter sound.
Interface	: Hi-Speed USB (Dedicated connector with integrated type of digital, audio and video*) * mini-B compatible. Audio/Video output (NTSC or PAL selectable, monaural audio)
Communication Settings	: MTP, PTP
Power Source	: Battery Pack NB-5L (Rechargeable lithium-ion battery) AC Adapter Kit ACK-DC30
Operating Temperatures	: 0 – 40 °C (32 – 104 °F)
Operating Humidity	: 10 – 90%
Dimensions (excluding protrusions)	: 95.4 × 57.3 × 27.4 mm (3.76 × 2.26 × 1.08 in.)
Weight (camera body only)	: Approx. 155 g (5.47 oz.)

Battery Capacity

Number of Images Shot		Playback Time
LCD Monitor On Playback Time (Based on the CIPA standard)	LCD Monitor Off	
Approx. 320 images	Approx. 800 images	Approx. 7 hours

- The actual figures will vary according to the shooting conditions and settings.
- Movie data is excluded.
- At low temperatures, the battery performance may diminish and the low battery icon  (blinks red) may appear very rapidly. In these circumstances, the performance can be improved by warming the battery in a pocket before use.

Test Conditions

Shooting: Normal temperature (23 °C ±2 °C/73 °F ±3.6 °F), normal relative humidity (50% ±20%), alternating wide angle end and telephoto end shots at 30 second intervals with the flash fired once every two shots and the camera power turned off after every tenth shot. Power is left off for a sufficient amount of time*, then the power is turned back on and the testing procedure is repeated.

• A Canon-brand memory card is used.

* Until the battery returns to normal temperature





















Playback: Normal temperature (23 °C ±2 °C/73 °F ±3.6 °F), normal relative humidity (50% ±20%), continuous playback at 3 seconds per image.



See *Battery* (p. 210).

Memory Cards and Estimated Capacities

: Memory card included with the camera











Recording Pixels	Compression	32 MB	SDC-128M	SDC-512MSH
L (Large) 3648 × 2736 pixels		6	28	110
		11	47	186
		23	99	386
M1 (Medium 1) 2816 × 2112 pixels		10	45	176
		17	75	292
		37	156	603
M2 (Medium 2) 2272 × 1704 pixels		14	61	237
		26	109	425
		52	217	839
M3 (Medium 3) 1600 × 1200 pixels		29	121	471
		52	217	839
		99	411	1590
S (Small) 640 × 480 pixels		111	460	1777
		171	711	2747
		270	1118	4317
 (Date Stamp) 1600 × 1200 pixels		52	217	839
W (Widescreen) 3648 × 2048 pixels		8	37	147
		15	64	249
		31	132	511

: Capable of smooth continuous shooting (p. 78) (When card has been formatted with a low level format).

This reflects standard shooting criteria established by Canon. Actual results may vary according to the subject and shooting conditions.



Movie

: Memory card included with the camera

	Recording Pixels/ Frame Rate		32 MB	SDC-128M	SDC-512MSH
 Standard	 640P	640 × 480 pixels 30 frames/sec.	14 sec.	1 min. 1 sec.	3 min. 57 sec.
 Color Accent	 640P	640 × 480 pixels 30 frames/sec. LP	27 sec.	1 min. 56 sec.	7 min. 30 sec.
 Color Swap	 320P	320 × 240 pixels 30 frames/sec.	38 sec.	2 min. 42 sec.	10 min. 29 sec.
 Compact	 160P	160 × 120 pixels 15 frames/sec.	3 min. 9 sec.	13 min. 2 sec.	50 min. 21 sec.
 Time Lapse	 1" *1	640 × 480 pixels	7 min. 30 sec.	31 min. 45 sec.	2 hrs. 3 min. 30 sec.
	 2" *2		15 min.	1 hr. 3 min. 30 sec.	4 hrs. 7 min.

*1 1 frame/sec. (shooting interval: 1 sec.)

*2 0.5 frame/sec. (shooting interval: 2 sec.)











- Maximum movie clip length at : 3 min., : 2 hours. The figures indicate the maximum continuous recording time.
- As  plays back at 15 frames/sec., the recording time and the playback time will differ.











Sound Recorder Data Rates and Recording Durations (Estimated)

: Card included with the camera

	Sound Size	32 MB	SDC-128M	SDC-512MSH
11.025 kHz	22 KB/sec.	23 min. 28 sec.	1 hr. 36 min. 59 sec.	6 hrs. 14 min. 16 sec.
22.050 kHz	44 KB/sec.	11 min. 44 sec.	48 min. 30 sec.	3 hrs. 7 min. 8 sec.
44.100 kHz	88 KB/sec.	5 min. 52 sec.	24 min. 15 sec.	1 hr. 33 min. 34 sec.

Image Data Sizes (Estimated)

Recording Pixels	Compression		
			
 3648 × 2736 pixels	4332 KB	2565 KB	1226 KB
 2816 × 2112 pixels	2720 KB	1620 KB	780 KB
 2272 × 1704 pixels	2002 KB	1116 KB	556 KB
 1600 × 1200 pixels	1002 KB	558 KB	278 KB
 640 × 480 pixels	249 KB	150 KB	84 KB
 1600 × 1200 pixels	–	558 KB	–
 3648 × 2048 pixels	3243 KB	1920 KB	918 KB

	Recording Pixels/Frame Rate		File size
 Standard		640 × 480 pixels 30 frames/sec.	1963 KB/sec.
 Color Accent		640 × 480 pixels 30 frames/sec. LP	1003 KB/sec.
 Color Swap		320 × 240 pixels 30 frames/sec.	703 KB/sec.
 Compact		160 × 120 pixels 15 frames/sec.	131 KB/sec.
 Time Lapse	 *1	640 × 480 pixels	64 KB/sec.
	 *2		32 KB/sec.

*1 1 frame/sec. (shooting interval: 1 sec.)

*2 0.5 frames/sec (shooting interval: 2 sec.)

SD Memory Card

Interface	Compatible with SD memory card standards
Dimensions	32.0 × 24.0 × 2.1 mm (1.26 × 0.94 × 0.08 in.)
Weight	Approx. 2 g (0.07 oz.)

MultiMediaCard

Interface	Compatible with MultiMediaCard standards
Dimensions	32.0 × 24.0 × 1.4 mm (1.26 × 0.94 × 0.06 in.)
Weight	Approx. 1.5 g (0.05 oz.)

Battery Pack NB-5L

Type	Rechargeable lithium-ion battery
Nominal Voltage	3.7 V DC
Typical Capacity	1120 mAh
Battery Life (Charge Cycles)	Approx. 300 times
Operating Temperatures	0 – 40 °C (32 – 104 °F)
Dimensions	32.0 × 44.9 × 7.9 mm (1.26 × 1.77 × 0.31 in.)
Weight	Approx. 25 g (0.88 oz.)

Battery Charger CB-2LX/CB-2LXE

Rated Input	100 – 240 V AC (50/60 Hz) 0.085 A (100 V) – 0.05 A (240 V)
Rated Output	4.2 V DC, 0.70 A
Charging Time	Approx. 2 hrs. 5 min. (for Battery Pack NB-5L)
Operating Temperatures	0 – 40 °C (32 – 104 °F)
Dimensions	57.5 × 81.6 × 21.0 mm (2.26 × 3.21 × 0.83 in.)
Weight	Approx. 65 g (2.29 oz.) (CB-2LX) Approx. 59 g (2.08 oz.) (CB-2LXE) (excluding power cord)

Compact Power Adapter CA-DC10

(Included with the separately sold AC Adapter Kit ACK-DC30)

Rated Input	100 – 240 V AC (50/ 60 Hz)
Rated Output	4.3 V DC, 1.5 A
Operating Temperatures	0 – 40 °C (32 – 104 °F)
Dimensions	42.6 × 104.4 × 31.4 mm (1.68 × 4.11 × 1.24 in.)
Weight	Approx. 180 g (6.35 oz.) (excluding power cord)

Index

Numerics

3:2 Guide 114

A

AC Adapter Kit ACK-DC30 214

Accessory 36

AE Lock 99

AF Frame 50, 93

AF Lock 98

AF-assist Beam 40, 55

AF-Point Zoom 90

Auto Category 115

AUTO Mode 16

Auto Rotate 183

B

Battery

Battery Charge Indicator 51

Capacity 222

Charging 10

Installing 11

C

Camera Shake Warning 51, 193

Card

Estimated Capacities 223

Formatting 178

Installing 11

Checking Focus 90, 120

Clock Display 47

Components Guide 40

Compression 71

Computer

Connecting 29

Downloading Images 27

System Requirements 27

Continuous Shooting 78

Control Dial 43

Create Folder 181

D

Date and Time 14

Date Stamp 22

Date/Time

Clock Display 47

World Clock 175

Default setting 54

Digital Tele-Converter 62

Digital Zoom 62

Direct Print Compatible Printers

..... 37

Direct Transfer 31

Display Language 15

Display Overlays 114

DPOF Print Settings 165

DPOF Transfer Settings 172

E

Embedding the Date in the

Image Data 22

Erasing 19, 158

Exif Print 220

F

Face Detect 93

Face Select and Track 96

FE Lock 100

File Numbering 179

- Flash
 - Settings 80
 - Shooting 66
- Focus 17
- Focus Check Display ... 60, 91, 120
- Focus Lock 98
- Frame Rates 86

- G**
- Grid Lines 114

- H**
- High-Power Flash 215
- Histogram 53

- I**
- Image Stabilizer 72
- Index Playback 119
- Indicators 46
- Infinity 67
- ISO Speed 74

- J**
- Jump (Searching the Images) .. 122

- L**
- LCD Monitor 41, 60
 - Display 50
 - Quick-bright LCD Function 61
- Lens Retract 58
- List of Messages 201
- Long Shutter Mode 103

- M**
- Macro 67
- Manual Mode 78
- Memory Cards
 - Estimated Capacities 223

- Menu
 - FUNC. Menu 54
 - My Camera Menu 59
 - Play Menu 56
 - Print Menu 56
 - Rec. Menu 54
 - Set up Menu 57
 - Settings 48
 - Metering Mode 102
 - Microphone 24, 42
 - Mode Dial 45
 - Movie
 - Editing 131
 - Shooting 24, 82
 - Viewing 26, 131
 - Mute 57
 - My Camera 188
 - Changing 188
 - Registering 189
 - My Category 124
 - My Colors 107
 - My Colors (Playback) 147

- N**
- Night View 61

- O**
- Overexposure Warning 53

- P**
- Playback Button 44
- Power Saving 57, 174
- Pressing Fully 17, 25
- Pressing Halfway 16, 25
- Print List 21
- Print Method 58
- Print/Share Button 42, 116
- Printing 20
- Protect 154

R

Rec. Review	17
Recording Pixels	70, 86
Red-Eye Correction (Playback)	142
Red-Eye Correction (Shooting) ..	80
Red-Eye Reduction	80
Registering Functions Set Play Button	163
Registering Settings	116
Reset All	184
Resize	149
Review	55
Review Info	55
Rotate	134

S

Safety Zoom	63
Self-Timer	68
Shooting Mode	75
Color Accent	109
Color Swap	111
Digital Macro	66
Functions Available	232
Special Scene	75
Stitch Assist	88
Shutter Button	16, 42
Slide Shows	136
Sound Memos	151
Sound Recorder	152
System Map	34

T

Telephoto	62
Time Lapse	87
Time Zone	175
Transfer Settings (DPOF)	172
Transition	135
Trimming	127
TV Set	186

V

Video Output Signal	58, 186
Viewfinder	41
Volume	57

W

White Balance	104
Wide Angle	62
Wrist Strap	13

Disclaimer

- While every effort has been made to ensure that the information contained in this guide is accurate and complete, no liability can be accepted for any errors or omissions.
- Canon reserves the right to change the specifications of the hardware and software described herein at anytime without prior notice.
- No part of this guide may be reproduced, transmitted, transcribed, stored in a retrieval system, or translated into any language in any form, by any means, without the prior written permission of Canon.
- Canon makes no warranties for damages resulting from corrupted or lost data due to a mistaken operation or malfunction of the camera, the software, SD memory cards (SD cards), personal computers, peripheral devices, or use of non-Canon SD cards.

















Trademark Acknowledgments

- Microsoft, Windows Vista and the Windows Vista logo are trademarks or registered trademarks of Microsoft Corporation in the United States and/or other countries.
- Macintosh, the Mac logo, QuickTime and the QuickTime logo are trademarks of Apple Inc., registered in the U.S. and other countries.
- The SDHC logo is a trademark.

Functions Available in Each Shooting Mode

Only functions with settings that change with the shooting mode are listed here.

Function		Shooting Mode	CAM					CAM	
			CM	Long Shutter	P	A/S	TV		CM
Exposure Compensation (p. 101)			○	—	○	—	○	—	
Long Shutter Mode (p. 103)			—	○	—	—	—	—	
ISO Speed (p. 74)	Auto ¹⁾		○	—	○	○	○	○	
	High ISO Auto		○	—	○	—	—	○	
	ISO 80 – 1600		○	○	○	—	—	—	
White Balance (p. 104)	Auto ¹⁾		○	○	○	○	○	○	
	Other than Auto		○	○	○	—	○	—	
Drive Mode (pp. 68, 78)	Single Shot		○	○	○	○	○	○	
	Continuous		○	○	○	—	—	—	
	Self-timer	2 sec. / 10 sec.		○	○	○	○	○	○
		Custom Timer		○	○	○	—	—	○
My Colors (p. 107)			○	○	○	—	○	—	
Metering System (p. 102)	Evaluative		○	○	○	○	○	○	
	Center Weighted Average		○	—	○	—	—	—	
	Spot		○	—	○	—	—	—	
Number of Recording Pixels, Compression (still images) (pp. 70, 71)			○	○	○ ³⁾	○	○ ³⁾	○	
Date Stamp (Date, Date & Time) (p. 22)			○	○	—	○	—	○	
Number of Recording Pixels, Frame Rate, (movies) (p. 82)	640 × 480, 30 fps / 30 fps LP		—	—	—	—	—	—	
	640 × 480, 1/0.5 fps		—	—	—	—	—	—	
	320 × 240, 30 fps		—	—	—	—	—	—	
	160 × 120, 15 fps		—	—	—	—	—	—	
AE Lock (p. 99)			○	—	○	—	—	—	
FE Lock (p. 100)			○	—	—	—	—	—	
AF Lock (p. 97)			○	○	○	—	—	—	
Shooting Zone (p. 67)	Normal		○	○	—	○	○	○	
	Macro		○	○	○	○	○	○	
	Infinity		○	○	—	○	○	—	
Face Select and Track (p. 96)			○	○	○	○	—	○	
Flash (p. 66)	Auto		○	—	—	○	—	○	
	On		○	○	—	○	○	—	
	Off		○	○	○	○	○	○	
LCD Monitor Setting (p. 60)	Off		○	○	—	—	—	○	
	No Information		○	○	○	—	—	○	
	Information View		○	○	○	○	○	○	

SCN														
														
○	○	○	○	○	○	○	○	○	○	—	—	—	—	—
—	—	—	—	—	—	—	—	—	—	—	—	—	—	—
○	○	○	○	○	○	○	○	○	○	—	○	○	○	○
—	—	—	—	—	—	—	—	—	—	—	—	—	—	—
—	—	—	—	—	—	—	—	—	—	— ²⁾	—	—	—	—
○	○	○	○	○	○	○	○	○	○	○	○	○	○	○
—	—	—	—	—	—	—	—	—	—	—	○	○	○	—
○	○	○	○	○	○	○	○	○	○	○	○	○	○	○
○	○	○	○	○	○	○	○	○	○	○	—	—	—	—
○	○	○	○	○	○	○	○	○	○	○	○	○	○	○
○	○	○	○	○	○	○	○	○	○	○	—	—	—	—
—	—	—	—	—	—	—	—	—	—	—	○	○	○	—
○	○	○	○	○	○	○	○	○	○	○	○	○	○	○
—	—	—	—	—	—	—	—	—	—	—	—	—	—	—
—	—	—	—	—	—	—	—	—	—	—	—	—	—	—
○	○	○	○	○	○	○	○	○	○	○ ⁴⁾	—	—	—	—
○	○	○	○	○	○	○	○	○	○	—	—	—	—	—
—	—	—	—	—	—	—	—	—	—	—	○	—	—	○
—	—	—	—	—	—	—	—	—	—	—	—	—	○ ⁵⁾	—
—	—	—	—	—	—	—	—	—	—	—	○	—	—	○
—	—	—	—	—	—	—	—	—	—	—	—	○	—	—
—	—	—	—	—	—	—	—	—	—	—	○	○	○	—
—	—	—	—	—	—	—	—	—	—	—	—	—	—	—
—	—	—	—	—	—	—	—	—	—	—	○	○	○	—
○	○	○	○	○	○	○	○	○	○	○	○	○	○	○
○	○	—	○	—	○	○	○	—	○	○	○	○	○	○
○	○	—	○	—	○	○	○	—	○	○	○	○	○	○
○	○	○	○	○	○	○	○	—	○	○	—	—	—	—
○	○	○	○	○	○	○	○	—	—	—	—	—	—	—
○	○	○	○	○	○	○	○	—	○	—	—	—	—	—
○	○	○	○	○	○	○	○	○	○	○	—	—	—	—
○	○	○	○	○	○	○	○	○	○	○	—	—	—	—
○	○	○	○	○	○	○	○	○	○	○	○	○	○	○
○	○	○	○	○	○	○	○	○	○	○	○	○	○	○

Function		Shooting Mode					CAM					
			Long Shutter									
Stitch Direction Selection (Right, Left) (p. 88)		—	—	—	—	○	—	—	—	—	—	
AF Frame (p. 93)	Face Detect	○	○	○	○	—	—	—	—	—		
	AiAF (9-point)	○	○	○	○	—	—	—	—	—		
	Center	○	○	○	○	○	○	○	○	○		
AF Frame Size Selection (p. 95)		○	○	—	—	—	—	—	—	—		
AF-Point Zoom (p. 90)		○	○	—	○	—	—	—	—	—		
Digital Zoom ⁶⁾ (p. 62)	Standard	○	○	○ ⁷⁾	—	—	—	—	—	—		
	Digital Tele-converter	○	○	—	—	—	—	—	—	—		
Flash Settings (p. 80)	Slow Synchro	○	○ ⁷⁾	—	—	○	—	—	—	—		
	Red-Eye Lamp	○	○	—	○	○	○	○	○	○		
	Red-Eye Correction	○	○	—	—	—	—	—	—	—		
Custom Timer (delay, shots) (p. 68)		○	○	○	—	—	—	—	—	—		
AF-assist Beam (p. 55)		○	○	○	○	○	○	○	○	○		
Review (Rec. Review) (p. 17)		○	○	○	○	○	○	○	○	○		
Review Info. (p. 55)	Off	○	○	○	○	○	○	○	○	○		
	Detailed / Focus Check	○	○	○	○	—	—	—	—	—		
Auto Category (p. 115)		○	○	○	○	○	○	○	○	○		
Disp. Overlay (p. 114)	Grid Lines	○	○	○	○	—	—	—	—	—		
	3:2 Guide / Both	○	○	○	○	—	—	—	—	—		
Registering settings to the Print/Share button (p. 116)		○	○	○	○	○	○	○	○	○		

- : Setting available or optimum value is automatically set by the camera. As a rule, with , only the first image is available.
 — : Not available.

- 1) Set to optimum value depending on each shooting mode.
- 2) The value is fixed to ISO 3200.
- 3) Date Stamp or Widescreen cannot be selected.
- 4) The recording size is fixed to Medium 3 (1600 × 1200).
- 5) 15 fps in playback mode.
- 6) Not available when Date Stamp or Widescreen is selected.
- 7) Always set to on.
- 8) Only available when the flash is set to [On].

SCN														
—	—	—	—	—	—	—	—	—	—	—	—	—	—	—
○	○	○	○	○	○	○	○	—	○	○	—	—	—	—
○	○	○	○	○	○	○	○	—	○	○	○	○	○	○
○	○	○	○	○	○	○	○	○	○	○	—	—	—	—
—	—	—	—	—	—	—	—	—	—	—	—	—	—	—
○	○	○	○	○	○	○	○	○	○	○	—	—	—	—
○	○	○	○	○	○	○	○	○	○	—	○	—	—	—
○	○	○	○	○	○	○	○	○	○	—	—	—	—	—
—	○ ⁷⁾	—	—	○ ⁷⁾	—	—	—	—	—	—	—	—	—	—
○	○	○	○	○	○	○	○	—	○	—	—	—	—	—
○	○	○	○	○	○	○	○	—	○	—	—	—	—	—
○	○	○	○	○	○	○	○	○	○	—	—	—	—	—
○	○	○	○	○	○	○	○	○	○	○	—	—	—	—
○	○	○	○	○	○	○	○	○	○	○	○	○	○	○
○	○	○	○	○	○	○	○	○	○	○	—	—	—	—
○	○	○	○	○	○	○	○	○	○	○	—	—	—	—
○	○	○	○	○	○	○	○	○	○	○	○	○	○	○
○	○	○	○	○	○	○	○	○	○	○	—	—	—	—
○	○	○	○	○	○	○	○	○	○	○	○	○	○	○

Canon