



APPLICATION AND DESIGN GUIDELINES



TABLE OF CONTENTS

Introduction 1

Piping Limits 1

Recommended Components 3

Liquid Line Quick Select 3

Vapor Line Quick Select 6

Long Line Requirements 6

Fundamentals and Theory 7

Line Sizing in Detail 9

System Control 21

System Operation 23

Appendix A 24

Appendix B — XC25 / XP25 Line Set Requirements . 33

Glossary 34

Introduction

The piping design of any air conditioning system will affect the performance, reliability, and applied cost of that system. The design of refrigerant piping systems involves capacity and efficiency, reliability, oil management, refrigerant charge, sound level, liquid refrigerant control, modulation effectiveness and cost. Therefore it is essential that the installing contractor understand the effect of piping and be able to make intelligent decisions in order to do the best job possible on the installation. This material below will clearly explain the basic effects on system performance of the piping design.

In most typical installations with lines less than 50 feet, the line sizes will match up to the connections on the outdoor unit. However, with installations involving long line sets or elevation differences between the outdoor unit and the indoor unit, the piping must be sized carefully. System performance may be improved even in a typical installation by optimizing pipe sizes.

IMPORTANT !

The intent of this manual is to represent generally accepted safe engineering practices. Specifications and limits outlined in this manual are subject to change. System design should conform to all codes, laws and regulations applying at the site at the time of installation. Additional documents that should be followed include The Safety Code for Mechanical Refrigeration and the Code for Refrigeration Piping, both available from ASHRAE. In addition, the procedures and limits outlined in this manual do not supersede local, state or national codes under any circumstances.

Piping Limits

All expansion valves (TXV) listed in the following tables can be used in either air conditioner or heat pump systems. These TXVs incorporate a check valve for heat pump system applications.

Table 1. Indoor HFC-410A —TXV

Unit Size	Catalog Number
2-Ton	Y0498
3-Ton	Y0499
4-Ton	Y0500
5-Ton	Y0501
6-Ton	Y0502

Table 2. Indoor HCFC-22 —TXV

Unit Size	Catalog Number
2-Ton	Y0512
3-Ton	Y0513
4-Ton	Y0514
5-Ton	Y0515
6-Ton	Y0516

COOLING SYSTEM

HFC-410A

- Total equivalent length = 240 feet (Piping and all fittings, etc).

NOTE — Length is general guide. Lengths may be more or less, depending on remaining system design factors.

- Maximum linear (actual) length = 200 feet.
- Maximum linear liquid lift = 60 feet.

NOTE — Maximum lifts are dependent on total length, number of elbows, etc that contribute to total pressure drop.

- Maximum length vapor riser = 125 feet.
- Up to 50 linear feet: use rated line sizes listed in unit specifications or installation instructions.



- If 51 to 80 linear feet: Crankcase heater required, non-bleed port TXV (see *TXV note*) preferred (RFCIV acceptable with maximum vertical of 25 feet).
- If 81 - 200 linear feet: Crankcase heater and non-bleed port TXV (see *TXV note*) required.
- Over 200 linear feet: not recommended.

TXV NOTE:

- a) Indoor Factory Installed non-bleed, non-adjustable TXV can be used on the system if it can maintain superheat lower than 25°F at outdoor unit service valve. Superheat is critical to compressor operating conditions.
- b) **If indoor unit does not have a factory installed TXV, or factory installed TXV needs replacing due to system match, up or the factory TXV is not capable of maintaining low enough superheats, use table 1 for ordering the correct TXV for specific size indoor unit.** All of these are indoor non-bleed adjustable thermostat expansion valves. Superheat adjustment procedures can be found in the TXV kit instruction.
 - If not factory provided, **high and low pressure switches are recommended**
 - If not factory provided, **a liquid line filter drier is required**
 - For HFC-410A recommend adding oil to system based on the amount of refrigerant charge in the system. No need to add oil in systems with 20 pounds of refrigerant or less. For systems over 20 pounds - add one ounce of every five pounds of refrigerant.

HCFC-22

Total equivalent length = 240 feet (Piping and all fittings, etc).

NOTE — Length is general guide. Lengths may be more or less, depending on remaining system design factors.

- Maximum linear (actual) length = 200 feet.
- Maximum linear liquid lift = 50 feet.

NOTE — *Maximum lifts are dependent on total length, number of elbows, etc that contribute to total pressure drop.*

- Maximum length vapor riser = 125 feet.
- Up to 50 linear feet: use rated line sizes listed in unit specifications or installation instructions.
- If 51 to 80 linear feet: Crankcase heater required, non-bleed port TXV (see *TXV note*) preferred (RFCIV acceptable with maximum vertical of 25 feet).
- If 81 - 200 linear feet: Crankcase heater and non-bleed port TXV (see *TXV note below*) required.
- Over 200 linear feet: not recommended.

TXV NOTE:

- a) **Indoor Factory Installed** non-bleed, non-adjustable TXV can be used on the system if it can maintain superheat lower than 25°F at outdoor unit service valve. (Superheat is critical to compressor operating conditions)
- b) **If indoor unit does not have a factory installed TXV, or factory installed TXV needs replacing due to system match, up or the factory TXV is not capable of maintaining low enough superheats, use table 2 for ordering the correct TXV for specific size indoor unit.** All of these are indoor non-bleed adjustable thermostat expansion valves. Superheat adjustment procedures can be found in the TXV kit instructions.
 - If not factory provided, **high and low pressure switches are recommended**
 - If not factory provided, **a liquid line filter drier is required**
 - For HFC-22 systems with suction lines over 50 feet with lines that are 7/8" or smaller, add three ounces of oil every 10 feet of line over 50 feet. For systems with 1-1/8" and larger suction lines, add four ounces of oil every 10 feet of line over 50 feet.

HEAT PUMP SYSTEM

HFC-410A

- Total equivalent length = 240 feet (Piping and all fittings, etc)

NOTE — Length is general guide. Lengths may be more or less, depending on remaining system design factors.

- Maximum linear (actual) length = 200 feet.
- Maximum linear liquid lift = 60 feet.

NOTE — Maximum lifts are dependent on total length, number of elbows, etc that contribute to total pressure drop plus when the outdoor unit is above the indoor unit.

- Maximum length vapor riser = 60 feet.
- Up to 50 linear feet: use rated line sizes listed in unit specifications or installation instructions.
- If 51 to 200 linear feet: Crankcase heater required, non-bleed port TXV (see *TXV note*) required.
- If 81 - 200 linear feet: Crankcase heater and non-bleed port TXV (see *TXV note below*) required.
- Over 200 linear feet: not recommended.

TXV NOTE:

- a) **Indoor Factory Installed** non-bleed, non-adjustable TXV can be used on the system if it can maintain superheat lower than 25°F at outdoor unit service valve. Superheat is critical to compressor operating conditions.



b) **If indoor unit does not have a factory installed TXV, or factory installed TXV needs replacing due to system match, up or the factory TXV is not capable of maintaining low enough superheats, use table 1 for ordering the correct TXV for specific size indoor unit.** All of these are indoor non-bleed adjustable thermostat check expansion valves. Superheat adjustment procedures can be found in the TXV kit instructions.

- If not factory provided, **high and low pressure switches are recommended.** Low pressure switch bypass switch will be required on units that do not have provision to ignore the switch when unit is operating in ambient temperatures below 15°F.
- If not factory provided, **a liquid line filter drier is required.**
- For HFC-410A recommend adding oil to system based on the amount of refrigerant charge in the system. No need to add oil in systems with 20 pounds of refrigerant or less. For systems over 20 pounds - add one ounce of every five pounds of refrigerant.

HCFC-22

- Total equivalent length = 180 feet (Piping and all fittings, etc).

NOTE — Length is general guide. Lengths may be more or less, depending on remaining system design factors.

- Maximum linear (actual) length = 150 feet.
- Maximum linear liquid lift = 50 feet.

NOTE — Maximum lifts are dependent on total length, number of elbows, etc that contribute to total pressure drop plus when the outdoor unit is above the indoor unit.

- Maximum length vapor riser = 50 feet.
- Up to 50 linear feet: use rated line sizes listed in unit specifications or installation instructions.
- If 51 to 150 linear feet: Crankcase heater required, non-bleed port TXV (*see TXV note below*) required.
- If 81 - 200 linear feet: Crankcase heater and non-bleed port TXV (*see TXV note*) required.
- Over 150 linear feet: not recommended.

TXV NOTE:

- a) **Indoor Factory Installed** non-bleed, non-adjustable TXV can be used on the system if it can maintain superheat lower than 25°F at outdoor unit service valve. (Superheat is critical to compressor operating conditions)
- b) **If indoor unit does not have a factory installed TXV, or factory installed TXV needs replacing due to system match, up or the factory TXV is not capable of maintaining low enough superheats, use table 2 for ordering the correct TXV for specific size indoor unit.** All of these are indoor non-bleed adjustable thermostat check expansion valves. Superheat adjustment procedures can be found in the TXV kit instructions.

- If not factory provided, **high and low pressure switches are recommended.** Low pressure switch bypass switch will be required on units that do not have provision to ignore the switch when unit is operating in ambient temperatures below 15°F.
- If not factory provided, **a liquid line filter drier is required.**
- For HFC-22 systems with suction lines over 50 feet with lines that are 7/8" or smaller, add three ounces of oil every 10 feet of line over 50 feet. For systems with 1-1/8" and larger suction lines, add four ounces of oil every 10 feet of line over 50 feet.

Recommend Components

PRESSURE TAPS

Should be installed at the inlet and outlets of indoor coils to allow field measurement of saturated pressures for calculating superheats and sub-cooling values.

ANTI-SHORT PROTECTION

Systems should have anti-short cycle.

- **ON** - usually four minutes.
- Timed **OFF** - usually five minutes and timer

NOTE — A number of electronic thermostats contain these features)

OPTIONAL SIGHT GLASS

A glass window type device placed in a liquid line and used for visual inspection of the liquid. It can also be used to determine the point at which all gas bubbles are removed from liquid line. A sight glass is not a good indicator of sub-cooling and cannot be used to determine charge. Optional Sight Glass Catalog Numbers are listed in table 3.

Table 3. Sight Glass Catalog Numbers

Liquid Line Size	Catalog Number
3/8"	57K19
1/2"	19B62
5/8"	19B63

Liquid Line Quick Select

Table 4 should be used to size the liquid line when there is a liquid lift. Follow this procedure for sizing the liquid line:

1. Find your unit on the left side of table 4.
2. Start with the rated liquid line size on the outdoor unit (refer to engineering handbook or installation instructions)
3. Read over to the linear length shown at the top of table 4.
4. Does maximum elevation meet your needs? If yes, use this size liquid line.
5. If not, consider the larger line size shown in table 4.

For variable capacity systems see section *Line Sizing in Detail*.

Table 4 simplifies liquid line selection by incorporating all of the calculations involving liquid line sizing, pressure drop, velocity range and tonnage.



Table 4. Liquid Line Quick Select

UNIT	UNIT TONS	LINE SIZE	HCFC-22								HFC-410A							
			UP TO 25 FEET	50	75	100	125	150	175	200	UP TO 25 FEET	50	75	100	125	150	175	200
012	1	5/16"	25	50	50	50	50	49	47	45	25	50	60	60	60	60	60	60
		3/8"	25	50	50	50	50	50	50	50	50	25	50	60	60	60	60	60
018	1.5	5/16"	25	50	48	44	41	37	33	29	25	50	60	60	55	51	46	42
		3/8"	25	50	50	50	50	50	50	49	49	25	50	60	60	60	60	60
024	2	5/16"	25	47	41	34	28	21	15	8	25	50	55	48	40	33	25	18
		3/8"	25	50	50	50	50	46	44	42	42	25	50	60	60	60	60	59
030	2.5	5/16"	25	45	38	30	23	15	8	NR	25	50	52	43	35	26	17	8
		3/8"	25	50	50	46	43	39	36	32	32	25	50	60	60	58	54	50
036	3	3/8"	25	50	46	41	36	32	27	22	25	50	60	56	51	45	39	34
		1/2"	25	50	50	50	50	50	50	50	50	25	50	60	60	60	60	60
042	3.5	3/8"	25	47	41	34	28	22	15	9	25	50	56	48	41	33	26	19
		1/2"	25	50	50	50	50	50	50	48	48	25	50	60	60	60	60	60
048	4	3/8"	25	44	36	28	20	12	4	NR	25	50	50	41	31	22	13	NR
		1/2"	25	50	50	50	50	49	47	45	45	25	50	60	60	60	60	60
060	5	3/8"	25	36	24	12	NR	NR	NR	NR	25	50	36	22	8	NR	NR	NR
		1/2"	25	50	50	49	47	44	41	38	38	25	50	60	60	60	59	56
072	6	1/2"	25	50	49	46	42	38	35	31	25	50	60	60	57	53	49	45
		5/8"	25	50	50	50	50	50	50	50	50	25	50	60	60	60	60	60
090	7.5	5/8"	25	50	50	50	50	50	50	48	25	50	60	60	60	60	60	60
		3/4"	25	50	50	50	50	50	50	50	50	25	50	60	60	60	60	60
120	10	5/8"	25	50	50	50	47	45	42	40	25	50	60	60	60	60	57	54
		3/4"	25	50	50	50	50	50	50	50	50	25	50	60	60	60	60	60
180 (2-COMP)	15	5/8" X 2	25	50	50	50	50	50	50	48	25	50	60	60	60	60	60	60
		3/4" X 2	25	50	50	50	50	50	50	50	50	25	50	60	60	60	60	60
240 (2-COMP)	20	5/8" X 2	25	50	50	50	47	45	42	40	25	50	60	60	60	60	57	54
		3/4" X 2	25	50	50	50	50	50	50	50	50	25	50	60	60	60	60	60

EXAMPLE 1: LIQUID LINE SIZING

Given: 10-ton, HCFC-22 A/C cooling only condensing unit on ground level with a 10 ton evaporator on the third level above ground (40 feet elevation) and a total of 100 feet (linear) of piping (see figure 1).

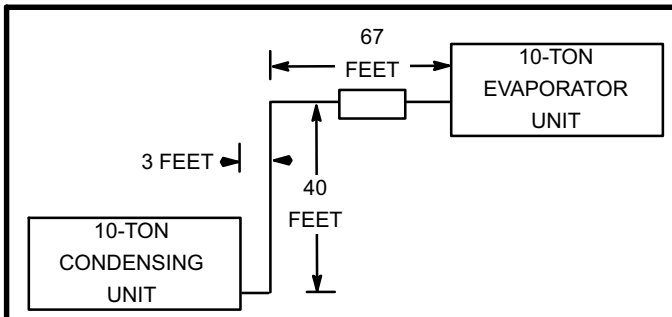

Figure 1. Liquid Line Sizing Example

Find: Select liquid line size from table 4.

Solution:

Find the 10-ton unit on the left side. Start with the 5/8" liquid line size which is the rated liquid line size listed in the engineering handbook. Read over to 100 feet of linear length.

50 feet of elevation is allowed for this liquid line size, so this meets the 40 foot requirement in this installation. If it did not meet your requirements, you would need to consider a larger liquid line listed for the 10 ton unit in table 4.



Table 5 – HCFC-22 and HFC-410A Vapor Lines

UNIT	UNIT TONS	SUCTION / VAPOR LINE SIZE	HCFC-22 PRESSURE DROP PSI/100 FEET	HFC-410A PRESSURE DROP PSI/100 FEET	PREFERRED FOR VERTICAL VAPOR RISES	PREFERRED FOR HORIZONTAL RUNS
012	1	1/2"	13.0	7.8	X	
		5/8"	3.1	1.9		X
018	1.5	5/8"	6.5	3.9	X	
		3/4"	2.4	1.4		X
024	2	5/8"	12.0	7.2	X	
		3/4"	4.2	2.5		X
030	2.5	3/4"	6.0	3.6	X	
		7/8"	3.1	1.9		X
036	3	3/4"	8.5	5.1	X	
		7/8"	4.6	2.8		X
042	3.5	7/8"	5.9	3.5	X	
		1-1/8"	1.4	0.8		X
048	4	7/8"	7.8	4.7	X	
		1-1/8"	1.9	1.1		X
060	5	7/8"	12.0	7.2	X	
		1-1/8"	2.8	1.7		X
072	6	1-1/8"	4.0	2.4	X	
		1-3/8"	1.4	0.8		X
090	7.5	1-3/8"	2.0	1.2	X	
		1-5/8"	0.9	0.5		X
120	10	1-3/8"	2.4	1.4	X	
		1-5/8"	1.4	0.8		X
180 (2-COMP)	15	1-3/8" X 2	2.0	1.2	X	
		1-5/8" X 2	0.9	0.5		X
240 (2-COMP)	20	1-3/8" X 2	2.4	1.4	X	
		1-5/8" X 2	1.4	0.8		X

Table 6. Desirable Characteristics

Key System Consideration	Desirable Characteristic	Piping System Impact
Reliability	Long Compressor Life	Poor oil management may shorten the life of the compressor. Proper liquid refrigerant control is essential.
Performance	High Capacity High energy efficiency Effective Modulation Low Sound Levels	Pressure drop in Refrigerant lines tends to decrease capacity and increase power consumption. High velocities can increase sound levels. Modulation often depends on proper piping.
Cost	Low Applied Cost	Amount of refrigerant charge, copper piping, accessories, and labor used will impact the applied cost.



Table 7. BTUH Loss For Equivalent Length (HFC-410A)

Nominal Tons	Tubing Outside Diameter (Inches)	BTUH Loss For Equivalent Length (HFC-410A)							
		25'	50'	75'	100'	125'	150'	175'	200'
2	5/8	-100	-275	-460	-667	-846	-1014	-1268	-1487
	3/4	0	-77	-169	-277	-384	-478	-602	-726
	7/8	46	0	-57	-130	-196	-265	-360	-487
3	3/4	-89	-270	-452	-652	-839	-1071	-1354	-1564
	7/8	0	-93	-167	-274	-407	-563	-742	-953
	1 1/8	52	13	-11	-74	-188	-318	-441	-611
4	3/4	-208	-575	-918	-1356	-1613	-2026	-2429	-2824
	7/8	0	-168	-320	-528	-726	-896	-1162	-1348
	1 1/8	114	80	19	-58	-148	-266	-391	-537
5	7/8	-221	-598	-948	-1305	-1716	-2063	-2438	-2844
	1 1/8	0	-109	-239	-398	-565	-741	-925	-1106
	1 3/8	52	-33	-133	-239	-339	-478	-572	-775

Vapor Line Quick Select

Table 2 should be used to size the vapor line. Follow this procedure for sizing the vapor line:

1. Find your unit on the left side of table 2 (for both HCFC-22 and HFC-410A)
2. Start with the rated vapor line size on the outdoor unit (refer to engineering handbook or installation instructions)
3. You may consider increasing or decreasing the vapor line size if a larger size is listed in table 2. Larger vapor lines will reduce pressure drop and improve system efficiency. For details see section *Line Sizing in Detail*.

Long Line Requirements

For systems with the outdoor unit 5-50 feet above the indoor unit, one trap must be installed at the bottom of the suction riser. For suction lifts between 50 and 100 feet (cooling only units; vapor lifts over 50 feet not allowed on heat pump), install a second trap halfway up the riser. For suction lifts over 100 feet, install traps at 1/3 intervals.

For variable capacity systems see section *Line Sizing in Detail*.

COMBINATION VAPOR LINES

Vapor risers must be sized to ensure adequate velocity for oil return. In general, piping can be designed to ensure adequate velocities for oil return even with two stage systems. A good way to do this is to reduce the vapor riser size. A combination vapor line can be constructed with the larger diameter pipe in the horizontal runs to minimize pressure drop, and smaller diameter pipe in the vertical to increase velocities.

NOTE — Maximum vapor riser = 125 feet

Table 5 simplifies vapor/suction line selection by incorporating all of the calculations involving vapor line sizing, pressure drop, velocity range and tonnage. To calculate capacity loss due to pressure drop in the vapor line refer to the section *Sizing Suction and Vapor Lines* in this document.

Assumptions: 2-4 elbows every 50 feet

EXAMPLE: VAPOR LINE SIZING

Given: 7-1/2 ton HCFC-22 A/C cooling only condensing unit with evaporator lower than condenser, with 112 feet of piping. The piping includes 20 feet of vertical lift and 92 feet of horizontal run as illustrated in figure 2.

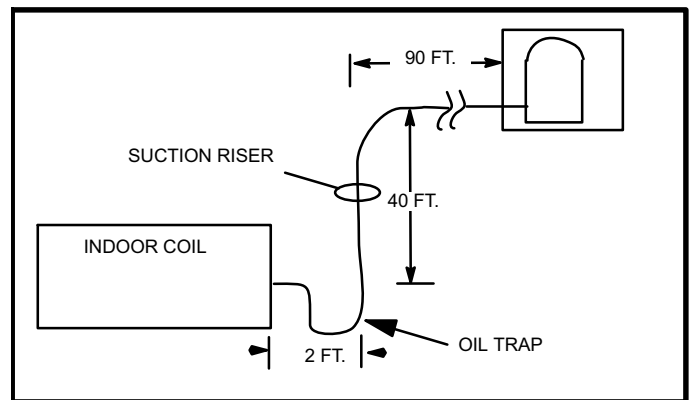

Figure 2. Indoor Coil Below Condenser

Find: Select vapor line size from table 5.

Solution: 1-3/8 inch outside diameter line is the rated suction line size. It is listed on table 5 because it will provide good refrigerant velocities for oil return.



Table 8. Equivalent Length in Feet of Straight Pipe for Valves and Fittings

LINE SIZE (OUTSIDE DIAMETER) INCH	SOLENOID /GLOBAL GLOBE VALVE	ANGLE VALVE	90° LONG* RADIUS ELBOW	45° LONG* RADIUS ELBOW	TEE LINE	TEE BRANCH
3/8	7	4	0.8	0.3	0.5	1.5
1/2	9	5	0.9	0.4	0.6	2.0
5/8	12	6	1.0	0.5	0.8	2.5
3/4	14	7	1.3	0.6	0.9	3.0
7/8	15	8	1.5	0.7	1.0	3.5
1-1/8	22	12	1.8	0.9	1.5	4.5
1-3/8	28	15	2.4	1.2	1.8	6.0
1-5/8	35	17	2.8	1.4	2.0	7.0
2-1/8	45	22	3.9	1.8	3.0	10
2-5/8	51	26	4.6	2.2	3.5	12

* Long radius elbow. Multiply factor by 1.5 for short radius elbow equivalent length.

Table 5 shows that a larger suction line size is available for this system. You may consider increasing the horizontal vapor line size to 1-5/8". This larger horizontal vapor line will reduce pressure drop and improve system efficiency. The larger vapor size is not advisable for the vertical vapor rise. Consult the section *Line Sizing in Detail* for exact velocity and pressure drop calculations.

ADDITIONAL REQUIREMENTS FOR AIR CONDITIONER SYSTEMS

Applications with less than 50 linear feet of refrigerant line may use fixed RFC metering devices on approved matchups as listed in engineering handbook. Plans with less than 50 linear feet of line and less than 20 feet of lift may also use OEM pre-fabricated line sets if available as listed in engineering handbook.

In applications where cooling operation below 50° F is anticipated and an economizer is not being used, low ambient (head pressure) controls must be installed. See Low ambient section in Appendix.

ADDITIONAL REQUIREMENTS FOR HEAT PUMP SYSTEMS

Some OEM equipment is equipped with a factory installed accumulator. Never add a second accumulator. If an accumulator is not supplied and one must be added, the accumulator must be properly sized and must be located in the suction line between the reversing valve and the compressor.

OEM heat pump units are factory equipped with a liquid line filter drier. Never install a liquid line filter drier in addition to factory installed driers due to risk of excess pressure drop and risk of improper installation. A bi-flow drier should be used with heat pump systems.

Special consideration must be given to heat pump systems when there is a difference in elevation between the outdoor and indoor units. Due to the reversal of refrigerant flow from heating to cooling cycle, there is always a liquid and suction lift to consider when sizing the refrigerant lines.

Maximum liquid lift should not exceed 50 linear feet for HCFC-22, or 60 linear feet for HFC-410A. Additional pressure drop due to friction will result in total pressure drop approaching the 30 psi maximum that could produce flashing in HCFC-22 systems (35 psi in HFC-410A systems).

Likewise, maximum suction lift must not exceed 50 feet for HCFC-22 or 60 feet for HFC-410A due to limitations placed on the liquid line. (When refrigerant flow is reversed, a liquid drop will become a liquid lift). The vapor line must be sized as a suction riser with adequate velocity for oil return if there is any difference in elevation between the indoor and outdoor units.

In applications where cooling operation below 50° F is anticipated and an economizer is not being used, low ambient (head pressure) controls must be installed.

Solenoid valves are uni-directional devices. Since solenoid valves are uni-directional, they are seldom used on heat pump systems. If used, they require a check valve to bypass refrigerant around the solenoid during the heating cycle. Never install a pump-down cycle on a heat pump system.

Fundamentals and Theory

The three prime considerations when designing a refrigerant piping scheme are:

1. System reliability
2. System performance
3. Cost

The desirable characteristics of any air conditioning system are described in table 8:

There are a number of ways that the piping system design can affect compressor reliability. Many compressors are susceptible to refrigerant slugging and oil dilution. Oversized liquid lines increase the amount of refrigerant in a system which creates the potential for these problems.

Undersized liquid lines can also create problems. Undersized liquid lines can cause refrigerant to flash before the expansion device. The result of a starved evaporator in this situation can be loss of capacity, evaporator coil frosting, or high superheat.



Suction lines and vapor lines must also be carefully sized. Oversized suction lines may result in refrigerant velocities being too low to return oil to the compressor. Undersized suction lines reduce capacity, cause increased refrigerant velocity sound and cause high superheat.

Long refrigerant lines have to be carefully planned. Excessive line length can reduce system capacity and lead to reliability problems.

The largest penalty for pressure drop is in the suction line. An acceptable pressure drop in the suction line is 3 PSI with HCFC-22 and 5 PSI with HFC-410A. In very long runs pressure drop can exceed these values. However, the most important function of the suction line is oil return, so in very long runs the higher pressure drop may be necessary.

The most important function of the liquid line is to deliver a solid column of 100% liquid refrigerant to the expansion device. Liquid lines are kept small to reduce the amount of system charge. As long as the pressure drop in the liquid line does not cause the refrigerant to flash, the liquid line diameter can be kept small. Adequate subcooling guarantees that the expansion device will see 100% liquid refrigerant.

Any pressure drop in the liquid line due to vertical lift must also be taken into consideration. This pressure drop should be added to the friction loss in the liquid line to figure the total pressure drop of the liquid line. The maximum acceptable pressure drop in the liquid line is 30 PSI for HCFC-22 and 35 psi for HFC-410A.

In order to keep installed cost down, the contractor should use the smallest possible tubing that will yield acceptable friction losses in the system.

OIL MANAGEMENT

Small amounts of oil from the compressor are constantly being circulating with the refrigerant throughout the system. This oil must be returned to the compressor for proper lubrication of bearings and contact surfaces. Suction and vapor lines must be sized carefully to eliminate oil management problems.

For systems with the outdoor unit 5-50 feet above the indoor unit, one trap must be installed at the bottom of the suction riser. For suction lifts between 50 and 100 feet (cooling only units; vapor lifts over 50 feet not allowed on heat pump), install a second trap halfway up the riser. For suction lifts over 100 feet, install traps at 1/3 intervals.

Oil return is a major consideration since some oil is continually being circulated with the refrigerant. Oil must be returned to the compressor by entrainment with the refrigerant vapor. *Minimum* velocity must be approximately 800 feet per minute (fpm) in horizontal runs, and approximately 1200 fpm in vertical suction risers.

HCFC-22

Lines over 50 feet and with suction line 7/8 inch outside diameter or smaller, add three ounces of oil for each 10 feet of line over 50 feet. For systems with 1-1/8 inch outside diameter and larger suction lines, add four ounces of oil for each 10 feet of line above 50 feet. Consult the OEM engineering handbook or installation instructions for proper oil type.

HFC-410A

Recommend adding oil to system based on the amount of refrigerant charge in the system. No need to add oil in systems with 20 pounds of refrigerant or less. For systems over 20 pounds - add one ounce of every five pounds of refrigerant.

EQUIVALENT LENGTH

Each valve, fitting, and bend contributes to friction pressure drop because of the interruption of smooth flow. Because it can be difficult to calculate the pressure drop of each fitting it is more useful to use equate the pressure drop to an equivalent length of straight tubing for each fitting. This makes it easier to add up the entire length of line, including fittings and valves, as an equivalent length of straight pipe. Pressure drop and line sizing tables are set up on the basis of pressure drop per 100 feet of straight pipe. The equivalent length of copper tubing for commonly used valves and fittings can be found in table 8.

PRESSURE DROP

Refrigerant piping involves complex relationships in the flow of refrigerant and oil. The flow of refrigerant involves the interaction of many factors, including velocity, pressure, friction, density, viscosity and the work required to force the flow. The nature of refrigerant flow is well understood because of practical experience. Any flow through a pipe leads to pressure drop or friction losses. The smaller the pipe the higher the pressure drop. Table NO TAG generally explains the effect of pressure drop in a refrigerant piping system.

Table 9. Location of Pressure Drop

Location of Pressure Drop	Affect On System Performance
Suction Line	Significantly reduces system capacity and efficiency
Hot Gas Lines	Reduces system capacity and efficiency
Liquid Line	No penalty on system performance as long as there is a solid column of liquid at the expansion device

Pressure drop is important from a performance standpoint. The following general statements point out the effects of pressure drop in the various components of the refrigeration piping system.

1. Pressure drop in the suction line reduces capacity and increases power consumption. For air conditioning systems, a one pound drop in the suction line reduces capacity approximately one percent. A suction line pressure drop of up to three psi for HCFC-22 (five psi for HFC-410A) is generally acceptable.



Table 10. Refrigerant Charge (Pounds) in 100 feet of Type L Copper Tubing

Line Size	3/8"	1/2"	5/8"	5/8"	3/4"	3/4"	7/8"	7/8"	1-1/8"	1-3/8"	1-5/8"	2-1/8"
	Liquid	Liquid	Liquid	Suction	Liquid	Suction	Liquid	Suction	Suction	Suction	Suction	Suction
HCFC-22	3.8	7.0	11.3	0.3	16.8	0.4	23.4	0.6	1.0	1.6	2.2	3.9
HFC-410A	3.1	5.8	9.2	0.4	13.8	0.6	19.2	0.8	1.3	2.0	2.9	5.0

2. Pressure drop in the liquid line produces no significant capacity loss as long as 100% liquid is delivered to the expansion valve and the pressure available is adequate to produce the required flow. Pressure drop due to lift must be added to the friction losses to determine total pressure drop. At normal liquid temperatures, HCFC-22 pressure drops 0.5 psi per foot of vertical liquid lift. HFC-410A pressure drops 0.43 psi per foot of vertical liquid lift.

One contributor to pressure loss in refrigerant lines is elbows and fittings. Figure 3 illustrates how lines can be run to avoid pressure losses.

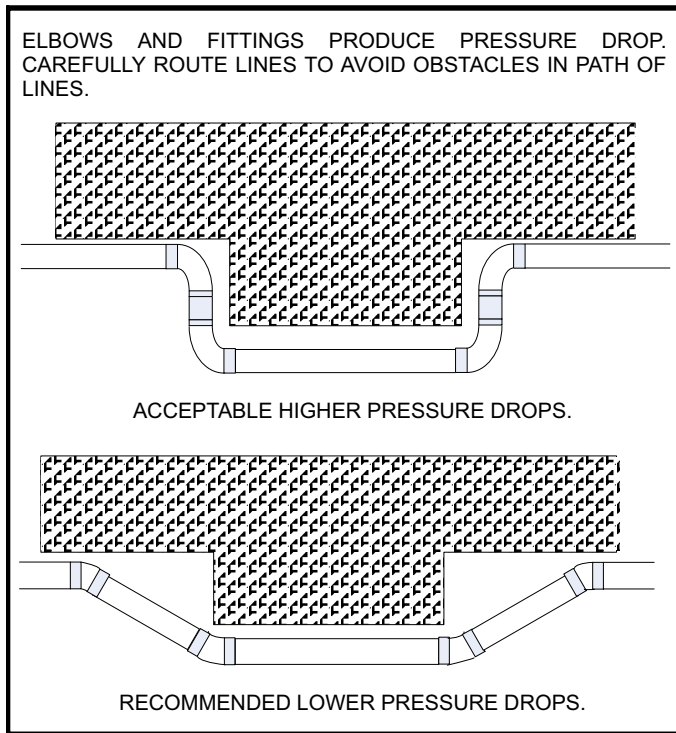

Figure 3. Pressure Drops

Line Sizing in Detail

The first step in the design of a piping system is to layout the entire system (i.e. relative location of the condensing unit and the evaporator, length of each segment of the piping system, length of suction risers and liquid risers etc). Start by making a sketch of the system including lengths of pipe, number of elbows, tees, valves, and any other irregular piping and fittings needed. This information will be used to determine total equivalent length for calculating pressure drop due to friction.

The same methods apply to both A/C and heat pump systems. A suction line sized to produce adequate velocity for oil entrainment and pressure drop with minimum capacity reduction will function properly as a hot gas

discharge line during a heating cycle. Also, if there is a vertical difference in height between the outdoor and indoor units, there is always a vapor and liquid lift to consider in sizing due to the reversal of refrigerant flow.

OEM split system condensing units and heat pumps (four tons and under) match with line sets of varying lengths of up to 50 feet (linear). These applications offer quick and simple installations that are trouble free if the line sets are properly installed. On split commercial applications and residential installations beyond 50 feet, special design considerations must be followed to assure satisfactory system performance. An improperly designed system could result in a serious loss of capacity or even compressor failure.

The purpose of the liquid line is to convey a full column of 100% liquid from the condenser to the metering device at the evaporator without flashing. The amount of liquid line pressure drop which can be tolerated is dependent on the number of degrees of liquid subcooling leaving the condenser and the saturated condensing temperature. If the condensing temperature and subcooling are known, the maximum allowable pressure drop can be calculated.

All OEM equipment is designed so that the charge may be adjusted to provide adequate subcooling leaving the outdoor unit. This will allow a 30 pound drop in the HCFC-22 liquid line (including pressure drop due to friction loss and vertical lift) and 35 psi in the HFC-410A liquid line. Refrigerant charge may be added to increase subcooling to overcome pressure drop due to liquid lift. Heat pumps require special consideration when adding charge because both cooling and heating modes must be considered. Consult the installation guide for the specific unit you are working with.

A major cause of compressor failure is liquid slugging. Due to the additional refrigerant required to fill the lines, the likelihood of slugging is greatly increased with lines over 50 feet in length. It is desirable to use the smallest liquid line that will not result in refrigerant flashing due to pressure drop. Table 10 shows that each incremental increase in liquid line size results in a 40 to 50 percent increase in liquid to fill the line.

The liquid line must not directly contact the vapor line. If the refrigerant line plan results in a pressure drop of 20 psi or more, the liquid line should be insulated in all places where it passes through an environment (such as an attic) which experiences temperatures higher than the subcooled refrigerant (approximately 105°F to 115°F liquid at 95°F ambient).

Refrigeration lines must not be buried in the ground unless they are insulated and waterproofed. Un-insulated copper lines buried in wet soil or under concrete can cause serious capacity loss and erratic operation as well as early failure due to corrosion. See Appendix for more information.



Systems with buried refrigerant lines can experience significant or total capacity loss if allowed to transmit heat to the surroundings. In addition, buried lines are susceptible to corrosion which can shorten the life of the system. For this reason, buried lines must rest inside a sealed, watertight, thermally insulated conduit. The lines must not contact the soil for any reason and the conduit must be designed so it cannot collect and retain water.

In all installations with lines over 50 feet, use only hard copper refrigeration tubing (clean and dry). Soft copper is prone to sagging in long horizontal runs. Elbows, Tees, Couplings and other joints should be made of wrought copper and elbows should be long radius. For leak free joints, properly clean tubing and fittings and use a brazing material with a minimum 5% silver content sil-phos. To prevent copper oxides from forming inside copper tubing it is necessary to bleed dry nitrogen through the tubing during the soldering process.

⚠ WARNING	
	Danger of fire. Bleeding the refrigerant charge from only the high side may result in the low side shell and suction tubing being pressurized. Application of a brazing torch while pressurized may result in ignition of the refrigerant and oil mixture - check the high and low pressures before unbrazing.

⚠ WARNING	
	When using a high pressure gas such as dry nitrogen to pressurize a refrigeration or air conditioning system, use a regulator that can control the pressure down to 1 or 2 psig (6.9 to 13.8 kPa).

The primary purpose of the liquid line is to ensure a solid column of liquid refrigerant at the expansion valve. Refrigerant velocity is not a consideration in the liquid line, since the oil will mix completely with the liquid refrigerant. Pressure loss is a consideration in the liquid line. If the pressure of the liquid refrigerant drops below its saturation temperature, some of the liquid will flash into vapor to cool the remaining liquid refrigerant to the new saturation temperature. This can occur in a liquid line if the pressure drops enough due to either friction loss or vertical lift.

Flash gas must be avoided in the liquid line. The only way to know for sure that a solid column of liquid is present at the expansion device is to check subcooling. A sight glass may be full of liquid, but bubbles can still form past the sight glass. Flash gas at the expansion device can erode damage a TXV, can cause noise, and may cause starvation of the evaporator coil. The section on System Control explains how to charge a unit using subcooling.

SIZING LIQUID LINES

Two factors must be considered when sizing liquid lines – pressure drop in the lines and pressure drop across the expansion device and distributor. The maximum pressure drop in the lines must be determined to ensure adequate subcooling at the expansion device. See examples below.

EXAMPLE 1: MAXIMUM ALLOWABLE PRESSURE DROP

A mid efficiency HCFC-22 unit operating at 10°F subcooling and 125°F (280 psi) condensing temperature, find the maximum allowable pressure drop in the liquid line. Refer to the pressure/ temperature chart (table 15) in the appendix. 125° F condensing temperature minus 10°F subcooling equals 115°F sub-cooled liquid temperature (245 psi - this is the pressure below which subcooled liquid will begin to form flash gas). 280 psi condensing pressure minus 245 psi subcooled pressure equals 35 psi.

Pressure drop in the liquid lines is not detrimental to system performance provided that 100% liquid is available entering the expansion device. For the most part, the generation of flash gas will be determined by the amount of pressure drop in the liquid line. To calculate total pressure drop in liquid lines, the following must be determined then added together:

1. Pressure drop due to friction in pipe (figure 4) fittings and field installed accessories such as a drier, solenoid valve or other devices (table 4). The pressure drop due to friction is usually smaller than pressure drop due to lift but must be considered. The pressure drop ratings of field installed devices is usually supplied by the manufacturer of the device and should be used if available.
2. Pressure drop due to vertical liquid lift (0.5 pound per foot for HCFC-22 and 0.43 pound per foot for HFC-410A) is usually large and may be a limiting factor in the ultimate design of the system.

Next, the pressure entering the expansion device must be sufficient to produce the required flow through the expansion device. A pressure drop of 100 psi for HCFC-22 (175 psi for HFC-410A) across the expansion valve and distributor is necessary to produce full refrigerant flow at rated capacity. Therefore, it is necessary for liquid refrigerant (free of flash gas) to be delivered to the expansion valve at a minimum of 175 psi for HCFC-22 or 340 psi for HFC-410A.

EXAMPLE 2: MAXIMUM ALLOWABLE PRESSURE DROP

A high efficiency HFC-410A unit operating at 6°F subcooling and 115°F (390 psi) condensing temperature, find the maximum allowable pressure drop in the liquid line. Refer to the pressure/ temperature chart in the appendix. 115° F condensing temperature minus 6°F subcooling equals 109°F sub-cooled liquid temperature (360 psi – this is the pressure below which subcooled liquid will begin to form flash gas), 390 psi condensing pressure minus 360 psi subcooled pressure equals 30 psi.



HCFC-22 LIQUID LINE PRESSURE DROP/VELOCITY
 At 45°F Evaporating Temperature and 125°F Condensing Temperature

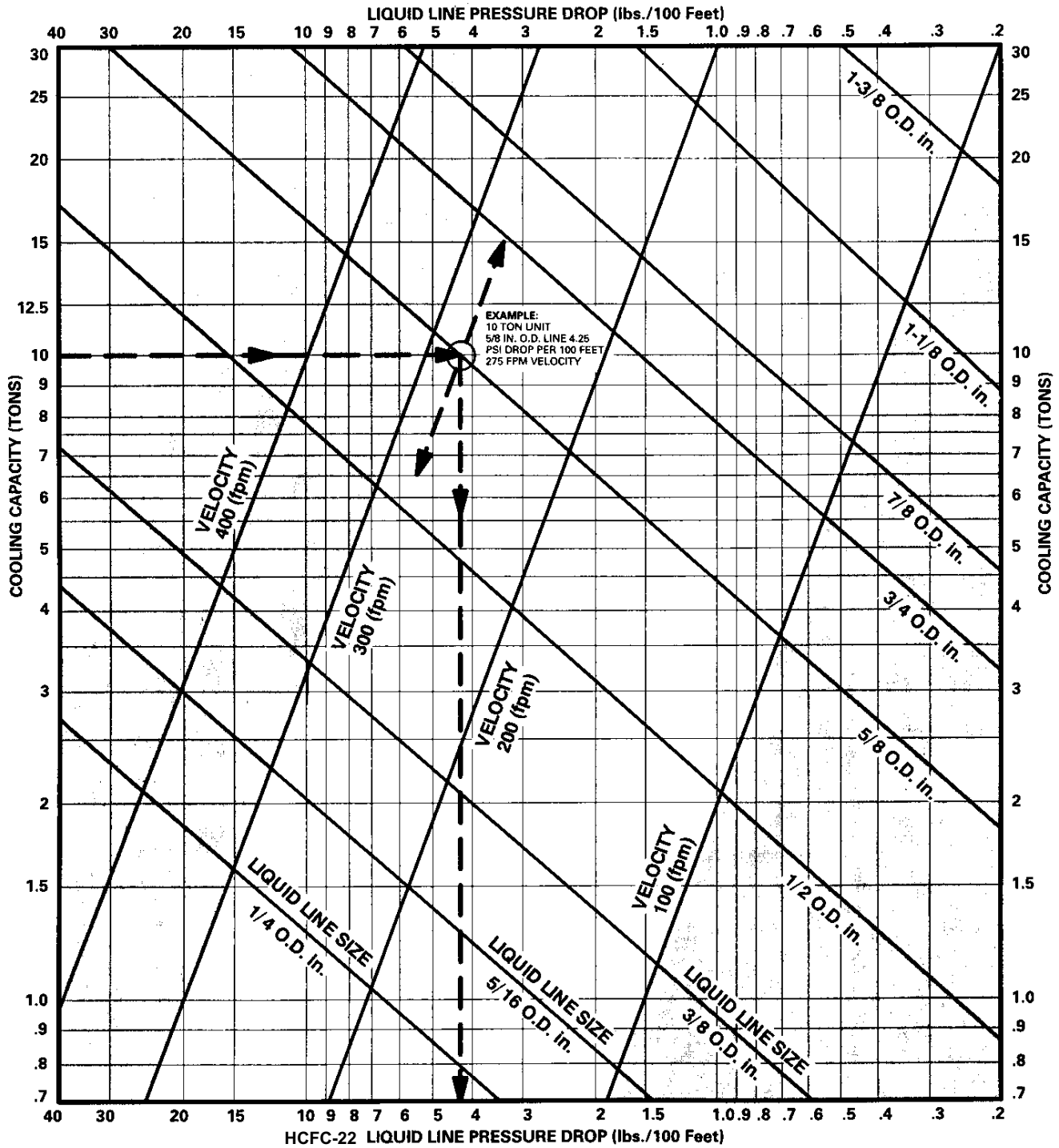

To use this chart, first find capacity (tons) on left side of chart. To find pipe size, proceed right to smallest pipe size. Pressure drop (vertical line) and velocity (diagonal lines) can then be determined for the pipe size selected. For example, for 10 ton unit, select 5/8 in. O.D. line.
 NOTE—Shaded area denotes unacceptable velocity range.

Figure 4. HCFC-22 Liquid Line



REFRIGERANT HFC-410A LIQUID LINE PRESSURE DROP/VELOCITY
 At 45°F Evaporating Temperature and 125°F Condensing Temperature

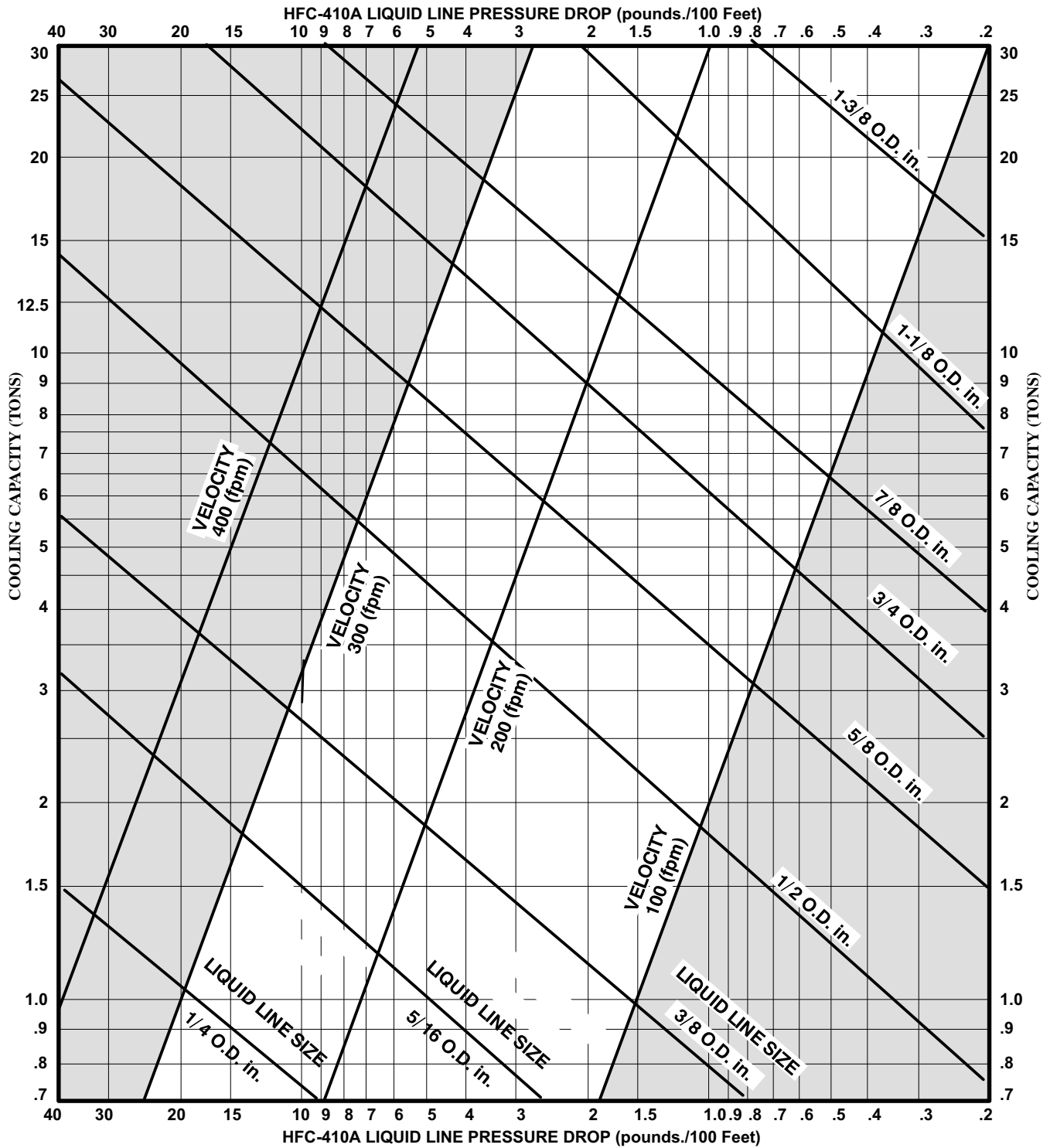

To use this chart, first find capacity (tons) on left side of chart. To find pipe size, proceed right to smallest pipe size. Pressure drop (vertical line) and velocity (diagonal lines) can then be determined for the pipe size selected. For example, for 10 ton unit, select 5/8 in. outside diameter. line.

NOTE—Shaded area denotes unacceptable velocity range.

Figure 5. HFC-410A Liquid Line



HCFC-22 SUCTION LINE PRESSURE DROP/VELOCITY PER 100ft. OF LINE
 At 45°F Evaporating Temperature and 125°F Condensing Temperature
 HCFC-22 SUCTION LINE PRESSURE DROP (lbs./100 Feet)

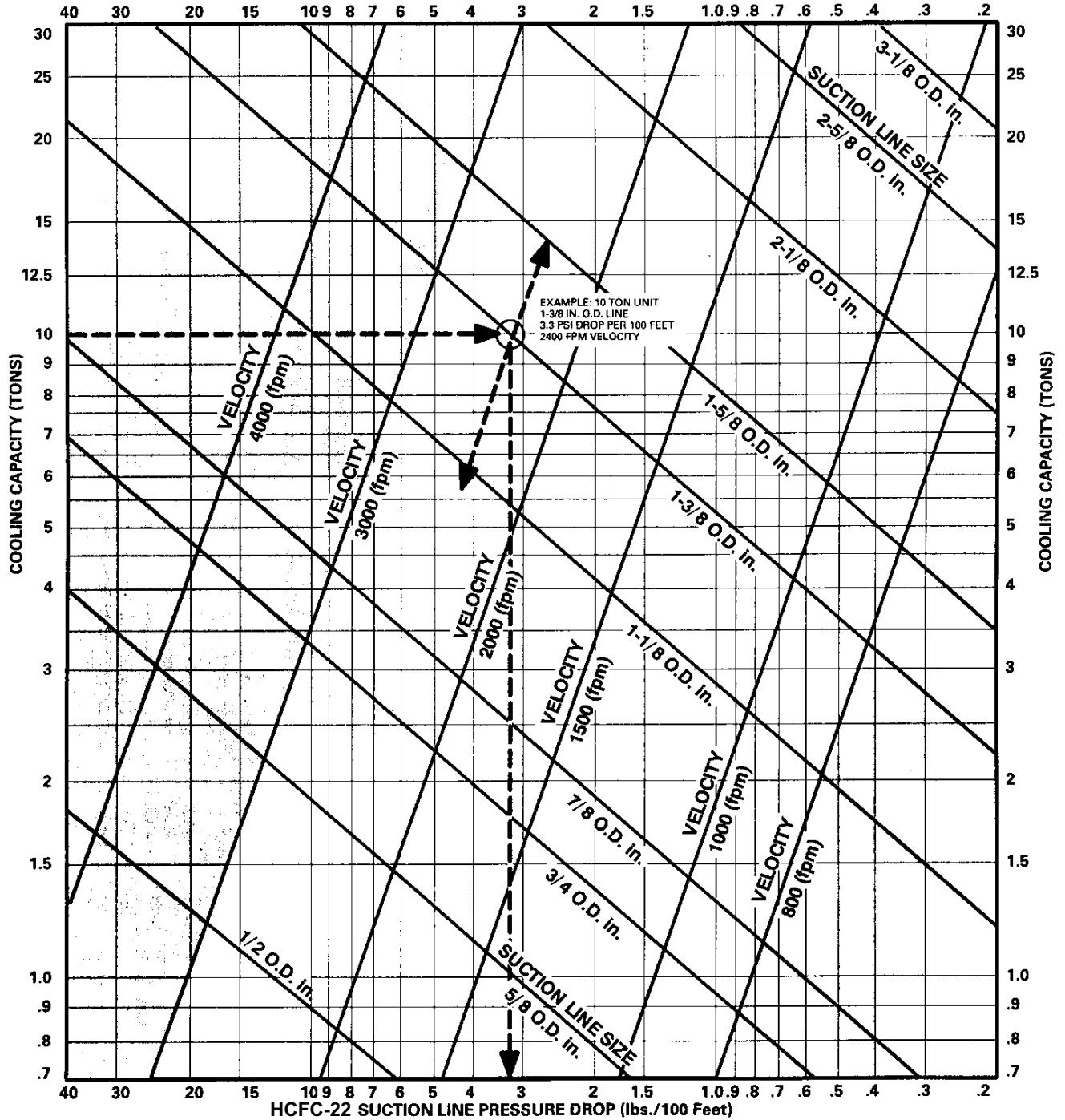

To use this chart, first find capacity (tons) on left side of chart. To find pipe size, proceed right to smallest pipe size. Pressure drop (vertical line) and velocity (diagonal lines) can then be determined for the pipe size selected. For example, for 10 ton unit, select 1-3/8 in. O.D. line.
 NOTE—Shaded area denotes unacceptable velocity range.

Figure 6. HCFC-22 Suction Line



REFRIGERANT HFC-410A SUCTION LINE PRESSURE DROP/VELOCITY PER 100ft. OF LINE
At 45°F Evaporating Temperature and 125°F Condensing Temperature

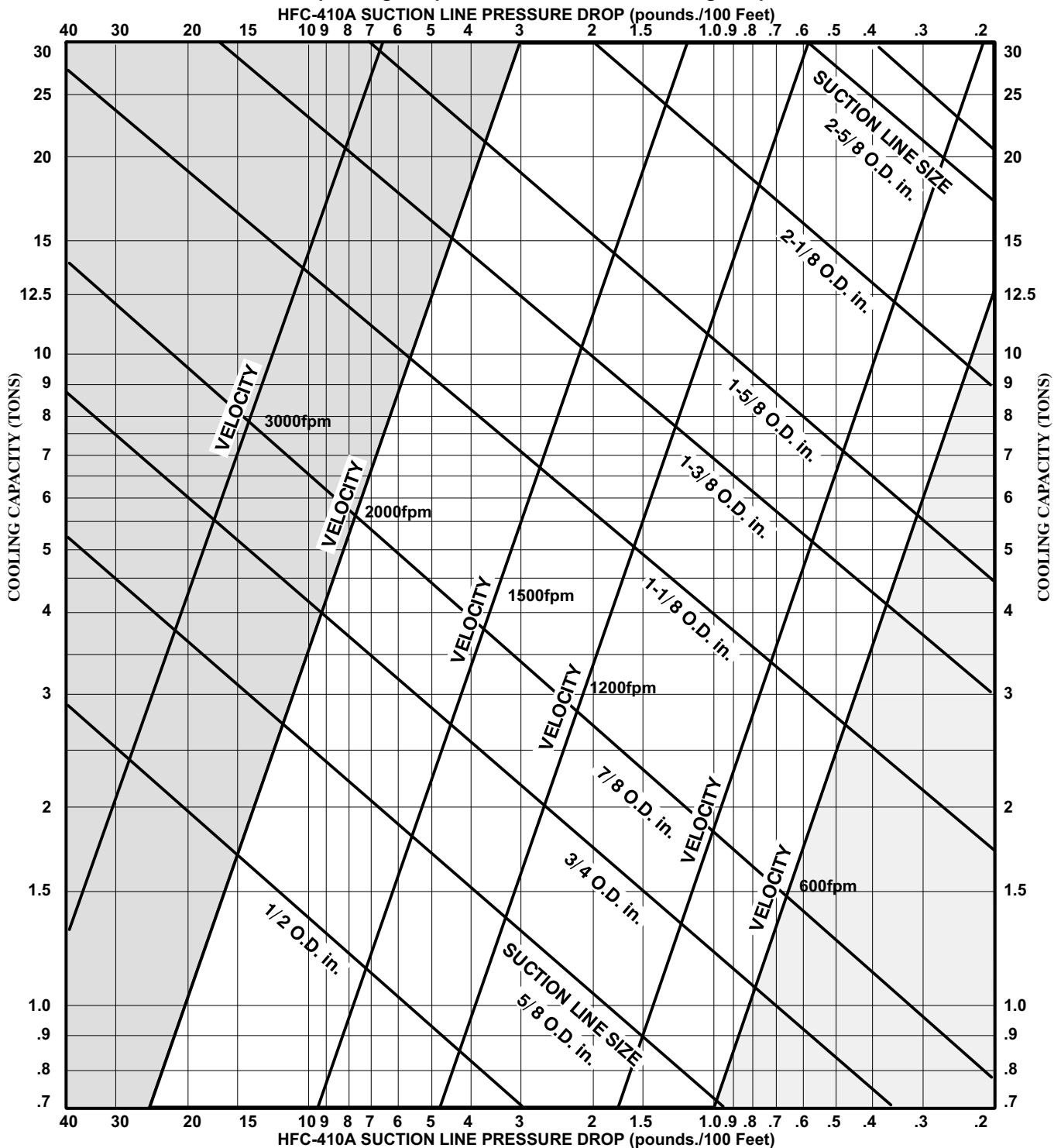

To use this chart, first find capacity (tons) on left side of chart. To find pipe size, proceed right to smallest pipe size. Pressure drop (vertical line) and velocity (diagonal lines) can then be determined for the pipe size selected. For example, for 10 ton unit, select 1-3/8 in. outside diameter line.
 NOTE—Shaded area denotes unacceptable velocity range.

Figure 7. HFC-410A Suction Line



EXAMPLE 5

Given: HCFC-22, 10-ton (single stage) condensing unit on ground level with a 10 ton evaporator on the third level above ground and a total of 96 feet (linear) of piping. Unit is charged with 10°F subcooling at 125°F condensing temperature (280 psi HCFC-22 liquid). See figure 8.

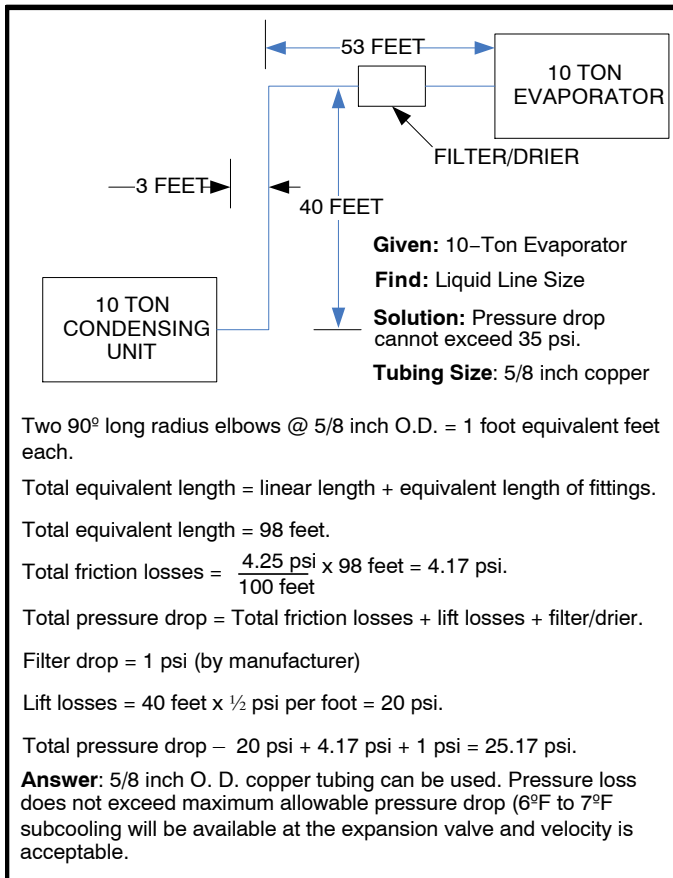

Figure 8. Liquid Line Sizing Example

Find: Select line size from figure 4.

Figure 4 illustrates the relationship between liquid line sizing, pressure drop per 100 feet, velocity range and tonnage. When using liquid line solenoid valves, velocities should not exceed 300 fpm to avoid liquid hammer when closing. Enter figure 4 from left and extend to the right to the smallest tube size that will not exceed 300 fpm velocity.

Solution: For a 10 ton system, 5/8 inch outside diameter line with 4.25 psi per 100 feet drop is selected. Now, calculate pressure drop due to friction and liquid lift to determine if this is a good selection.

The pressure lost to two elbows must be added to the equation. The total friction drop for 96 feet of 5/8 inch outside diameter. pipe plus (from table 8) 1 equivalent foot per elbow = 98 equivalent feet.

Figure 4 shows that, in a 10 ton system, we can expect 4.25 psi drop per 100 feet of 5/8 inch outside diameter. copper. When we multiply 4.25/100 by 98 equivalent feet, we see that the total friction loss is 4.17 psi.

Now, we must add the pressure drop for vertical lift. HCFC-22 pressure drop is 1/2 psi per foot of vertical lift. When multiplied by 40 feet vertical lift we find that pressure drop due to lift = 20 psi.

Finally, we have added a filter drier to the liquid line which has 1 psi drop (this number provided by manufacturer).

Add the three components of pressure drop together to find that the total pressure drop in this 5/8 inch line = 25.17 psi.

Now, by comparing 25.17 psi to our maximum allowable pressure drop we find that this setup falls well within the acceptable range. The 5/8 inch line, therefore, is a good selection because it is well below the maximum allowable pressure drop, is in a satisfactory velocity range, uses minimum refrigerant and provides sufficient pressure at the expansion valve.

ALTERNATIVE PIPE SIZE

Suppose 3/4 inch outside diameter. line with 1.6 psi drop per 100 feet had been selected. The total equivalent length is computed by adding the linear length (96 feet.) plus the equivalent length of the fittings (two 90° elbows at 1.25 feet each). The total equivalent length is 98.5 feet. The total friction drop would have been 1.6/100 multiplied by 98.5 feet = 1.57 psi. When the pressure drop due to lift (20 psi) and the filter drier (one psi) are added we find that the total pressure drop for 3/4 inch line = 22.57 psi.

Yet, 3/4 inch line is a less desirable choice. Why?

The difference in pressure drop between 5/8 inch line and 3/4 inch line is only 2.35 psi. But, the larger line adds 5.5 pounds. more refrigerant into the system (see table 10 on page 9). The risk of refrigerant slugging is increased and the smaller line will be less costly. The smaller line should be used.

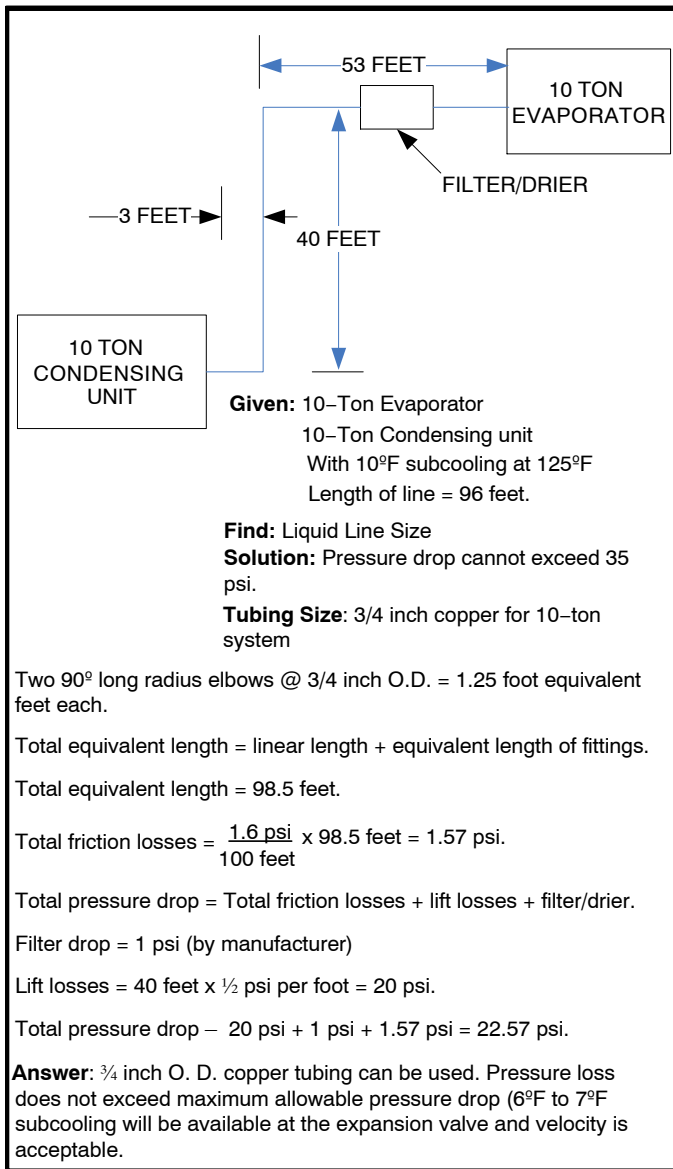

Figure 9. Liquid Line Sizing Example (Alternative)

SIZING SUCTION AND VAPOR LINES

The purpose of the suction line is the return of refrigerant vapor and oil from the evaporator to the compressor. The sizing of vertical risers is extremely important. Movement of oil droplets up the inner surface of the tubing is dependent on the mass velocity of the gas at the wall surface.

The larger the pipe the greater the velocity required at the center of the pipe to maintain a given velocity at the wall surface.

Suction line design is critical. The design must minimize pressure loss to achieve maximum unit efficiency and yet provide adequate oil return to the compressor under all conditions.

Because oil separates from the refrigerant in the evaporator, the suction velocity must be adequate to sweep the oil along. Horizontal suction lines require a minimum of 800 fpm velocity for oil entrainment. Suction risers require 1200 fpm minimum and preferably 1500 fpm regardless of the length of the riser.

Figure 6 illustrates the relationship between suction line sizing, pressure drop per 100 feet, velocity and cooling tonnage. This chart is used to determine suction line pressure drop which can then be used to determine suction line capacity loss. This chart can also be used to determine suction line velocity to assure oil return to the compressor.

Vertical lift does not significantly affect pressure drop. However, systems will lose approximately 1% capacity for every pound of pressure drop due to friction in the suction line. This 1% factor is used to estimate the capacity loss of refrigerant lines. To use the 1% factor, first you must use figure 6 to estimate the pressure drop in the total equivalent length of the lines you choose.

The Engineering Handbook capacity ratings of OEM split system equipment show the capacity when matched with a particular indoor coil and 25 feet. of refrigerant line. These capacity ratings have the loss for a 25 feet. refrigerant line already deducted. When you use this manual to estimate the capacity loss due to friction, you must calculate the pressure drop of the entire refrigerant line then subtract the pressure drop of a 25 feet. line. See figure 10. Remember, the objective is to hold refrigerant line capacity loss to a minimum and maintain velocity for adequate oil return.

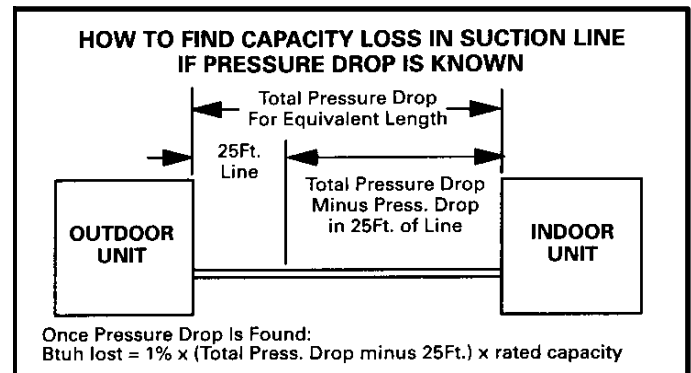

Figure 10. How to Find Capacity Loss

CONSIDERATIONS

When an evaporator is located above or on the same level as the condensing unit, the suction line must rise to the top of the evaporator. See figure 11. This helps prevent liquid from migrating to the compressor during the off cycle. Traps should also be installed at the bottom of all vertical risers.

In air conditioning systems, horizontal suction lines should be level or slightly sloped toward the condensing unit. In air conditioning and heat pump systems, pipe must avoid dips or low spots that can collect oil. For this reason, hard copper should be used, especially on long horizontal runs.

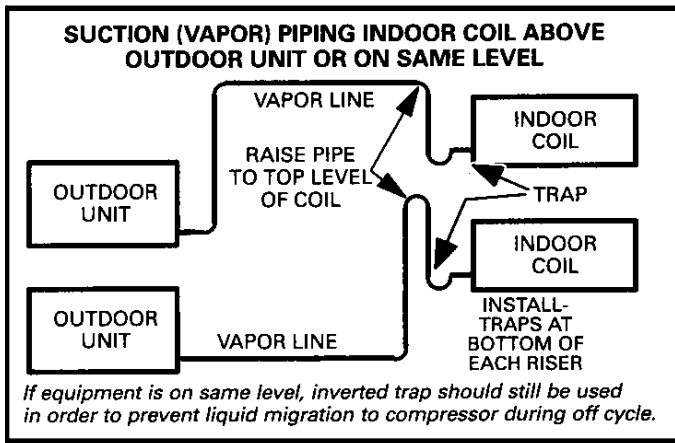

Figure 11. Suction Line Piping Indoor Coil above Outdoor Unit or Same Level

To aid in the return of oil, a trap should be installed at the bottom of any suction riser (remember, a heat pump vapor line can act as a suction riser when refrigerant flow is reversed).

When selecting suction/vapor line sizes, the following points must be remembered:

1. Velocity must be maintained in order to provide adequate oil return to the compressor.
2. Capacity loss must be held within the job requirements.

Field installed components, such as suction line driers, mufflers, etc. contribute to both pressure drop and capacity loss. The resultant pressure drop must be considered (see manufacturer's data for pressure drop information).

SIZING PROCEDURE

Before selecting pipe size, make a sketch of the layout complete with fittings, driers, valves etc. Measure the linear length of each line and determine the number of ells, tees, valves, driers etc. Add equivalent length of fittings (table 4) to linear length of pipe to get total equivalent length used in determining friction loss.

EXAMPLE 1: SUCTION LINE SIZING PROCEDURE

Given: Five ton HCFC-22 (60,000 Btuh) condensing unit on same level with condenser, with 65 feet of piping and eight elbows (as in figure 11).

Find: Select tube size from figure 6.

Figure 6 illustrates the relationship between suction line sizing, pressure drop per 100 feet, velocity range and tonnage.

Solution: Enter figure 6 from left (tons capacity) and extend to the right to the smallest tube size with velocity less than 3000 fpm.

Suction line velocity should not exceed 3000 fpm in order to avoid possible noise complaints. This rule may be slightly exceeded when added velocity is required to entrain oil vertically.

1-1/8 inch outside diameter line with 2.8 psi per 100 feet pressure drop and 1950 fpm velocity is selected. Now calculate pressure drop due to friction loss to determine if this is a good selection.

65 feet of pipe, plus eight elbows (1.8 equivalent feet each, from table 8) = 79.4 feet equivalent length.

When we multiply 2.8/100 by 79.4 equivalent feet, we see that the total friction loss is 2.22 psi.

1-1/8 inch line appears to meet the requirements in figure 6. Find the capacity loss in 1-1/8 in. line to determine net capacity.

Air Conditioning and Heat Pump system capacities are based on matched systems with 25 equivalent feet of refrigerant line operating at ARI conditions. As figure 10 shows, the pressure drop in 25 feet of line must be subtracted from the total equivalent length.

The pressure drop in 25 feet of 1-1/8 inch line is:

$$2.8/100 \text{ multiplied by } 25 = 0.7 \text{ psi}$$

The additional pressure drop for the line is:

$$2.22 \text{ psi minus } 0.7 \text{ psi} = 1.52 \text{ psi}$$

The capacity loss (figure 10) is:

$$0.01 \times 1.52 \times 60,000 = 912 \text{ Btuh or approximately } 1.5\%.$$

EXAMPLE 2: ALTERNATIVE PIPE SIZE

Suppose 7/8 inch outside diameter. line with a pressure drop of 12 psi per 100 feet had been selected. 65 feet of pipe, plus eight elbows (1.5 equivalent feet each) = 77 feet equivalent length. The total friction drop would be 12/100 multiplied by 77 = 9.24 psi.

The pressure drop in 25 feet of 7/8 inch line is:

$$12/100 \text{ multiplied by } 25 = 3 \text{ psi}$$

The additional pressure drop for the line is:

$$9.24 \text{ psi minus } 3 \text{ psi} = 6.24 \text{ psi}$$

The capacity loss (figure 10) is:

$$0.01 \times 6.24 \times 60,000 = 3744 \text{ Btuh or approximately } 6.24\%.$$

This is a poor selection for two reasons:

1. The high velocity may cause excess suction line noise.
2. The capacity loss may not be acceptable if the system is designed with close tolerance.

EXAMPLE 3: SUCTION LINE SIZING PROCEDURE

Given: 7-1/2 ton condensing unit with evaporator lower than condenser, with 112 feet of piping and four elbows. The piping includes 20 feet of vertical lift and 92 feet of horizontal run.

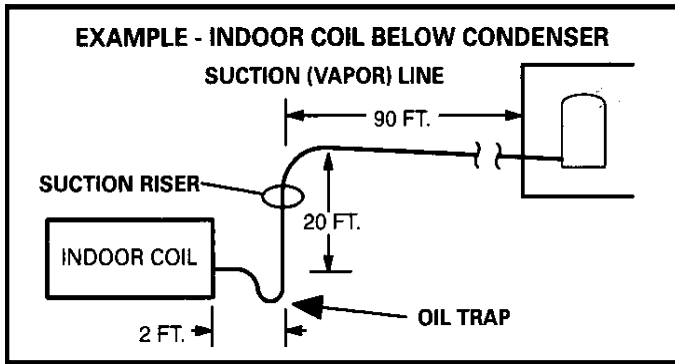

Figure 12. Indoor Coil Below Condenser

Find: Select tube size from figure 6.

Solution: 1-1/8 inch outside diameter. line with 6 psi per 100 feet pressure drop and 2900 fpm velocity is selected. Now, calculate pressure drop due to friction to determine if this is a good selection.

From table 8, four ells at 1.8 equivalent feet each = 7.2 equivalent feet. When added to the 112 feet of pipe, the total equivalent feet becomes 119.2 feet (round up to 120 feet).

When we multiply 6/100 by 120 equivalent feet, we see that the total friction loss is 7.2 psi.

Use figure 6 to calculate the pressure drop in 25 feet of 1-1/8 inch line. When we multiply 6/100 by 25 feet, we see that the friction loss is 1.5 psi.

The capacity lost in the **total equivalent length** of the refrigerant line (using figures 8 and 10) = $1\% \times (7.2 - 1.5) \times 90,000$.

$$\text{Btuh lost} = 0.01 \times (5.7) \times 90,000$$

$$\text{Btuh lost} = 5130$$

Capacity loss for the line selected is approximately 5.7%.

The preceding calculation shows that this is a workable system but will result in a loss of capacity and efficiency.

EXAMPLE 4: ALTERNATIVE PIPE SIZE

Using the same (7-1/2 ton) example, this time select 1-3/8 inch outside diameter. line. 1-3/8 inch outside diameter. line with 2 psi per 100 feet pressure drop has 1760 fpm velocity. Now calculate pressure drop due to friction loss to determine if this is a better selection.

From figure 5, four elbows at 2.4 equivalent feet each = 9.6 equivalent feet. When added to the 112 feet of pipe, the total equivalent feet becomes 121.6 feet (round up to 122 feet).

When we multiply 2/100 by 122 equivalent feet, we see that the total friction loss is 2.4 psi.

Use figure 6 to calculate the pressure drop in 25 feet of 1-3/8 inch line. When we multiply 2/100 by 25 feet, we see that the friction loss is 0.5 psi.

The capacity lost in the **total equivalent length** of the refrigerant line (using figures 8 and 10) = $1\% \times (2.4 - 0.5) \times 90,000$.

$$\text{Btuh lost} = 0.01 \times (1.9) \times 90,000$$

$$\text{Btuh lost} = 1710$$

Capacity loss for the line selected is approximately 1.9%.

The conditions in this example will allow either 1-1/8 inch or 1-3/8 inch suction line to be used since capacity loss is minimized and velocity is sufficient to return oil to the compressor.

EXAMPLE 5: SUCTION SIZING WITH VARIABLE CAPACITY — TWO STAGE CONDENSING UNIT

Some variable capacity installations may use a single suction riser for minimum load conditions without serious penalty at design load. OEM units with two-stage compressors have approximately 67% capacity at low stage and normally do not require double suction risers

Given: 15 ton two-stage condensing unit with a single 15 ton (dual circuit) evaporator.

High Stage Capacity = 15 tons and,

Low Stage Capacity = 9 tons.

The system is plumbed with the evaporator 60 feet below the condensing unit and 40 feet horizontally away from the condensing unit. A trap is plumbed at the bottom of the riser. The trap is composed of 90° ells.

Find: Determine if single suction riser is suitable or if double suction riser must be used.

TWO STAGE SIZING EXAMPLE

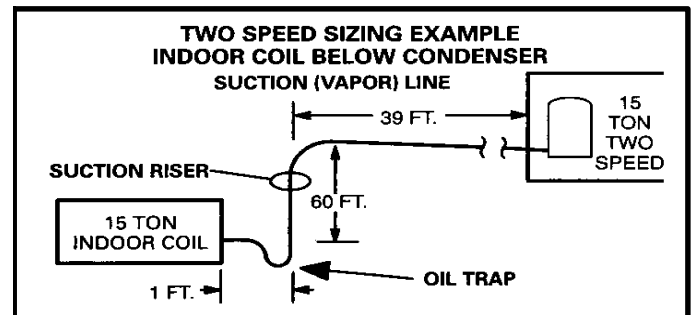

Figure 13. Two Speed Sizing Example

Solution: Select the line size based on full unit capacity (15 tons) 1-5/8 inch outside diameter. line with 3 psi per 100 feet pressure drop and 2600 fpm velocity (at full capacity) is selected. Then determine the equivalent length of the segment to calculate the pressure drop.

60 feet of pipe (vertical), plus 40 feet of pipe (horizontal), plus four 90° elbows (2.8 equivalent feet each) = 111.2 equivalent feet length (round to 111).

From figure 6, 1-5/8 inch outside diameter. suction line with 15 tons capacity has three psi drop per 100 feet. When we multiply 3/100 by 111 equivalent feet, we see that the total friction loss is 3.3 psi.

Use table 8 to calculate the pressure drop in 25 feet of 1-5/8 inch line. When we multiply 3/100 by 25 feet, we see that the friction loss is 0.75 psi.

The capacity lost in the **total equivalent length** of the refrigerant line (using figures 8 and 10) = $1\% \times (3.3 - 0.75) \times 180,000$.

Btuh lost = $0.01 \times (2.55) \times 180,000$

Btuh lost = 4590

Capacity loss for the line selected is approximately 2.55%.

LOW STAGE CAPACITY

1-5/8 inch line appears to be appropriate for this system operating at full (15 ton) capacity. Now we must check the low stage (9 ton) capacity to determine if 1-5/8 inch line is appropriate.

OEM two stage units operate at approximately 60% capacity when operating on low stage:

15 tons \times 0.6 = 9 tons (if an engineering data sheet is available use the actual capacities rather than this approximation).

Nine tons capacity when used with 1-5/8 inch pipe (figure 8) indicates a velocity of 1500 fpm. This is sufficient to return oil to the compressor and meets the requirement of maintaining at least 1200 fpm in vertical risers.

When comparing high stage to low stage performance in this case we find that a single 1-5/8 inch suction riser may be used and double suction risers are not required.

EXAMPLE 1: SUCTION SIZING VARIABLE CAPACITY – HOT GAS BYPASS

There are two basic types of hot gas bypass kits. The most desirable is the type that feeds the hot gas from the compressor discharge line to a side tap on the distributor in the evaporator coil. When installed in this manner, full flow of suction gas is maintained in the suction line and suction piping should follow standard procedures as outlined in the previous sections.

The second type of hot gas bypass is installed and connected within the condensing unit. This is known as a run-around hot gas bypass in that hot compressor discharge gas and liquid from the liquid line are circuited to the hot gas bypass valve and directly into the suction line. This method reduces flow through the evaporator and suction line. Special handling of suction risers is required.

Refer to OEM instructions for proper installation of the hot gas bypass kit.

When to Use Double Suction Risers

If a condensing unit can unload more than 50% either by a hot gas bypass (run-around cycle) or other mechanical means, double suction risers may be required.

If the condensing unit unloads less than 50%, suction lines can be generally sized in accordance with the previous sections. If the suction velocity is high enough to entrain oil when the unit is operating at reduced capacity, double suction risers are generally not required.

In general, double suction risers are required any time the minimum load on the compressor does not create sufficient velocity in vertical suction risers to return oil to the compressor. Double suction risers are also generally required any time the pressure drop or velocity in a single suction riser is excessive.

How Double Suction Risers Work

Figure 14 shows a typical double suction riser installation. A trap is installed between the two risers as shown. During partial load operation (figure 15) when gas velocity is not sufficient to return oil through both risers, the trap gradually fills with oil until the second riser is sealed off. When this occurs, the vapor travels up the first riser only. With only the first riser being used, there is enough velocity to carry the oil. **This trap must be close coupled to limit the oil holding capacity to a minimum.** Otherwise, the trap could accumulate enough oil on a partial load to seriously lower the compressor crankcase oil level.

The second suction riser must enter the main suction line from the top to avoid oil draining down the second riser during a partial load. See figure 15.

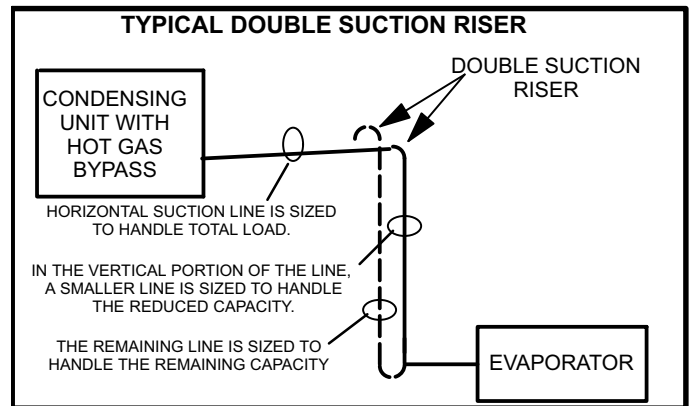

Figure 14. Typical Double Suction Riser

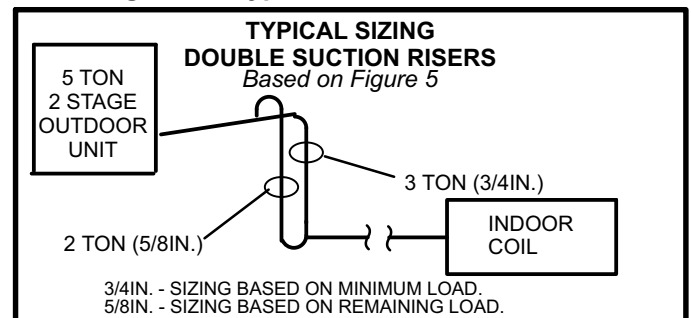

Figure 15. Typical Sizing - Double Suction Riser

Sample Calculation

Given: Ten ton condensing unit with hot gas bypass (runaround type) or mechanical unloaders capable of 65% unloading. Matched evaporator is located below condensing unit. Piping will require 57 (linear) feet of pipe (figure 16). Construction without double suction risers will only require 2 ells.

Find:

1. Select tube sizes for horizontal runs and risers (figure 6).
2. Determine if double suction risers are needed.
3. Size double suction riser for proper system performance.

Solution: Size each segment based on the tons of refrigerant that will flow in the segment.

Full load capacity = 10 tons. Minimum load capacity is 35% of 10 tons = 3.5 tons. The difference between full capacity and part load capacity is 6.5 tons.

From figure 6, select a pipe size for full load capacity. 1-3/8 inch outside diameter. pipe with 3.3 psi drop per 100 feet and 2400 fpm velocity is selected. Now, by using figure 6, find the velocity for the selected pipe size at part load capacity. The part load velocity is approximately 850 fpm. 850 fpm is sufficient to return oil in horizontal runs but not in vertical risers.

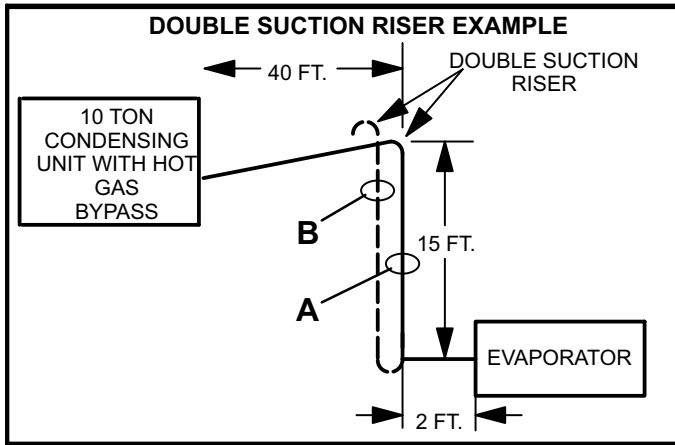

Figure 16. Double Suction Riser

If we tried to size this system by simply reducing the riser size to 1-1/8 inch, we would find the velocity in the riser to be excessive (3800 fpm) when the system is operating at full capacity. As a result of these obstacles, this system will require construction of double suction risers. Construction of double suction riser will require five ells and two tees total for a system.

Size small riser — Riser carrying smallest part of load

The unit produces 3.5 tons capacity at minimum load. Select from figure 6 a 7/8 inch outside diameter. line (smallest line with acceptable velocity). When operating at 3.5 tons capacity, this line will operate at 2500 fpm and will produce 6 psi drop per 100 feet.

Size larger riser — Riser carrying largest part of load

The larger line carries 6.5 tons capacity at full load. Select from figure 6 a 1-1/8 inch outside diameter. line (smallest line with acceptable velocity). When operating at 6.5 tons capacity, this line will operate at 2500 fpm and will produce 4.5 psi drop per 100 feet.

Putting the Segments Together

Next, we must determine if the line sizes we selected will result in satisfactory pressure drop between the condensing unit and the evaporator.

Start by finding the total equivalent feet of the large (B) riser. 15 feet of pipe, plus two tees (branch side of tee at 4.5 equivalent feet each), plus four elbows (1.8 equivalent feet), plus one tee (line side of tee at 1.0 equivalent feet) = 21.0 equivalent feet length.

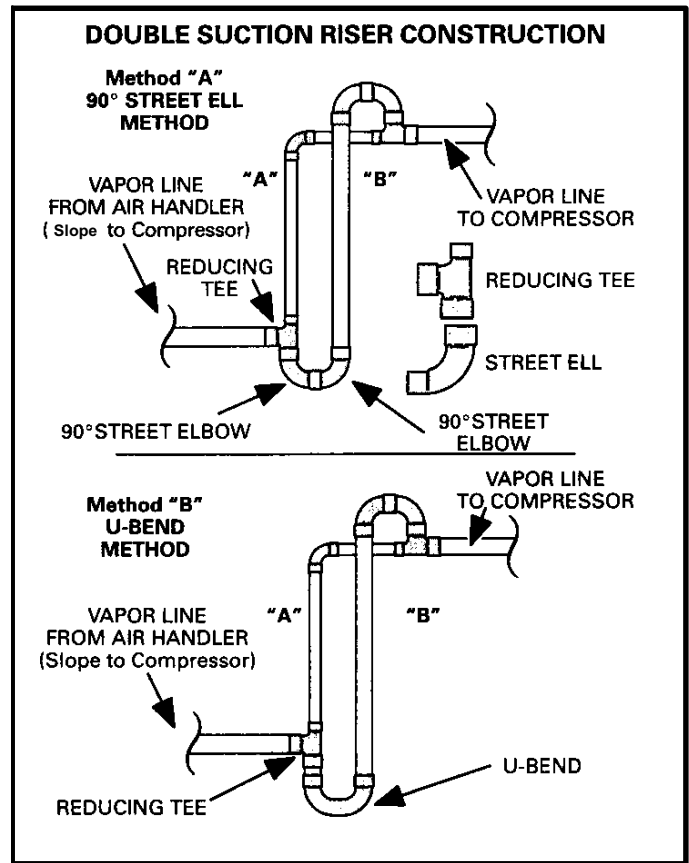

Figure 17. Double Suction Riser Construction

Use the total equivalent length of each riser to compute the pressure drop of each riser. For the large (B) riser, 1-1/8 inch outside diameter. suction line with 6.5 tons capacity has 4.5 psi drop per 100 feet. When we multiply 4.5/100 by 31.2 equivalent feet, we see that the total friction loss is 1.4 psi.

For the small (A) riser, 7/8 inch outside diameter. suction line with 3.5 tons capacity has six psi drop per 100 feet. When we multiply 6/100 by 21 equivalent feet, we see that the total friction loss is 1.26 psi.

The total pressure drop for the riser is equal to the average of the pressure drop in both risers:

$$1.4 \text{ (B riser pressure drop)} + 1.26 \text{ (A riser pressure drop)} = 2.66$$

$$2.66 \div 2 = 1.33 \text{ (average pressure drop through A and B risers).}$$

Find the pressure drop for the horizontal run of pipe. 1-3/8 inch pipe at 10 tons of capacity has 3.3 psi drop per 100 feet. When we multiply 3.3/100 by 61 equivalent feet, we see that the total friction loss is 2.01 psi.

The pressure drop through the risers is added to the pressure drop through the horizontal run to find the total pressure drop for the system:

$$2.01 \text{ psi (horizontal run)} + 1.33 \text{ psi (avg. riser)} = 3.34 \text{ psi.}$$

Use figure 6 to calculate the pressure drop in 25 feet of 1-3/8 inch line. When we multiply 3.3/100 by 25 feet, we see that the friction loss is 0.825 psi.



The capacity lost in the **total equivalent length** of the refrigerant line (using figures 6 and 10) = $1\% \times (3.34 - 0.825) \times 120,000$.

Btuh lost = $0.01 \times (2.515) \times 120,000$

Btuh lost = 3018

Capacity loss for the line selected is approximately 2.5%.

Two Stage Applications

Many two stage applications will require a reduction in suction riser size to maintain adequate velocity for oil return at low stage. For example, a 5-ton two stage system will normally use a 1-1/8 inch suction line (figure 6). A suction riser in this system may be reduced to 7/8 inch pipe size while the horizontal runs may use 1-1/8 inch pipe size.

Figure 6 shows the tradeoffs that will result from downsizing the riser. The disadvantage is that the riser will exceed 3000 fpm when operating at full capacity (potential for sound transmission). In addition, the pressure drop in the smaller line will result in significantly greater pressure drop (capacity loss). The advantage is that the smaller line will guarantee sufficient velocity for oil return when operating at reduced capacity.

If, by reducing the riser pipe size, the pressure drop (capacity loss) becomes unacceptable, the system must be designed with double suction risers.

Accumulators

Accumulators have to pipe in between the reversing valve and compressor on heat pumps, which usually do not have room, especially in the under 5-ton units. Accumulator sizing should be based on total system charge. A good rule of thumb is to select an accumulator that can accommodate 2/3 of the total system charge.

Accumulators are not normally required on cooling only systems with a non bleed TXV and crankcase heater.

Suction line size may be increased to minimize pressure drop, provided that velocities are adequate. Liquid line sizes should never be increased or decreased. Larger liquid lines will add unnecessary charge to the system.

If liquid refrigerant is allowed to flood through an air conditioning system and return to the compressor before being evaporated, it may cause damage to the compressor due to liquid slugging, loss of oil from the crankcase, or bearing washout. To protect against this condition on systems vulnerable to liquid damage, a suction accumulator may be necessary.

Flooding typically can occur on heat pumps at the time the cycle is switched between heating and cooling, reversal before and after defrost, and during low ambient heating operation. Flooding can also occur during normal pressure equalization at system shut off, especially in systems with large refrigerant charges. This is true for both heat pumps and air conditioners.

The accumulator's function is to intercept liquid refrigerant before it can reach the compressor crankcase. It should be located in the compressor suction line between the evaporator and the compressor, and must have provisions

for a positive return of oil to the crankcase so that oil does not become trapped in the accumulator. The liquid refrigerant and oil must be metered back to the compressor at a controlled rate to avoid damage to the compressor.

The actual refrigerant holding capacity needed for a suction accumulator is governed by the requirements of the particular application, and should be selected to hold the maximum liquid refrigerant flood back anticipated.

One of the most critical areas of heat pump application is the proper control of liquid refrigerant under low ambient heating conditions. System design must maintain a delicate balance between sufficient flooding to adequately cool the compressor, while avoiding excessive flooding which would adversely affect lubrication. When coil defrost is required, the compressor is exposed to sudden surges of liquid that can create extreme stresses in the compressor.

The accumulator can act as a reservoir for refrigerant during the heating cycle when system imbalance or an overcharge from field service result in excessive liquid refrigerant in the system, storing the refrigerant until needed and feeding it back to the compressor at an acceptable rate.

Major movements of refrigerant take place at the initiation and termination of a defrost cycle, and while it is not necessary or even desirable to stop this movement, it is essential that the rate at which the liquid refrigerant is fed back to the compressor be controlled. Again the accumulator can effectively maintain the crankcase temperature at acceptable limits.

System Control

To operate at rated capacity and efficiency, all air conditioning and heat pump systems must be properly charged. Most equipment manufactured in recent years depends on subcooling to attain rated capacity and efficiency. See definition of subcooling in glossary of terms. A unit can operate at what appears to be normal pressure and temperature, and if the refrigerant charge does not provide the proper subcooling for the application, as much as 8 to 10% of its capacity can be lost without any reduction in power consumption.

Some OEM equipment is designed to operate at peak efficiency with less than 10°F subcooling. Yet, if the refrigerant incurs much restriction, such as that experienced in vertical lift, less subcooling may not be adequate and a loss of capacity will be experienced.

OEM equipment is designed so the refrigerant charge may be adjusted in order to obtain 10-12°F subcooling on HCFC-22 units, 6-8°F subcooling on HFC-410A units.

Many charging methods are available (charts, superheat, approach, sight glass) but none of these methods will assure you of a solid column of liquid at the expansion valve. A favorite of the service technician has been the sight glass. It will show that a solid column of liquid is present, but it will not provide information regarding subcooling. A common problem with a sight glass in a long line system is that flash gas can form after the sight glass and before the expansion valve. The sight glass should not be used to determine proper system charge.

HOW TO CHARGE A UNIT USING SUBCOOLING

1. Indoor temperature must be between 70°F and 80°F.
2. Measure liquid line temperature with temperature sensor.
3. Hook up gauges to liquid and suction lines.
4. Turn on unit (cooling mode if heat pump – high stage if two stage compressor) and operate long enough for pressure to stabilize (at least five minutes).
5. Read condensing temperature from gauge and read liquid line temperature from the thermometer.
6. To achieve 10°F subcooling, liquid line should be 10°F cooler than condensing temperature. The amount of subcooling will vary with outdoor temperature.

Add refrigerant to make liquid line cooler.

NOTE — If system is grossly overcharged, liquid line will get warmer as refrigerant is added.

NOTE — After checking charge, if suction pressure is excessively low, do not add charge. Check filters, air volume and check for restrictions in system (i.e., strainers, driers, expansion valve, etc.).

Recover refrigerant to make liquid line warmer.

LOW AMBIENT CHARGING (BELOW 70°F OUTDOOR TEMPERATURE.)

Airflow will need to be restricted in order to boost liquid line pressure above 240 psig for HCFC-22, or 400 psig for HFC-410A.

In order to obtain proper results, it is important that you block equal sections of the coil with cardboard, plastic sheet or similar material. On formed (wrap around) coils, the blockage should be applied totally covering the coil from top to bottom and then extending from side to side.

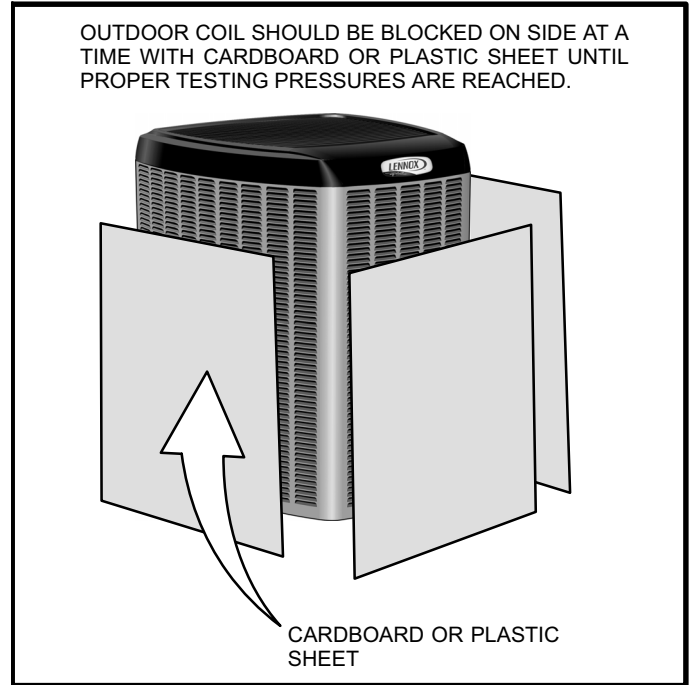

Figure 18. Blocking Outdoor Coil

Table 11. Low Ambient Cooling Recommendations

Product Family			Low Ambient Operation Without Low Ambient Kit Installed	Low Ambient Operation with Low Ambient Kit added and field installed Freezestat	Low Ambient Operation with Low Ambient Kit, field supplied Outdoor Fan Speed Control* and Freezestat Added
Split System Residential and Commercial	RFC Metering	A/C or Heat Pump	Down to 60°F	Kits not available. Operation below Down to 60°F is not recommended.
	Expansion	A/C	Down to 50°F	Down to 30°F	Down to 0°F
Heat Pump		Down to 50°F	Down to 30°F	Cooling Operation Below 30°F is not recommend.	

* Requires ball bearing motor construction. Outdoor fan motor may have to be changed in some instances.



OEM low ambient kits are available for all OEM (expansion valve equipped) units. These kits may need to be installed and may need to be supplemented with field installed equipment when applied to systems with long refrigerant lines. Field installed equipment may include any or all of the following: solenoid valve installed in the liquid line at the evaporator, pump-down controls, accumulator, additional crankcase heaters or capacity unloading.

Factory supplied low ambient kits may include low ambient thermostat, low pressure switch, relays or any combination of the above. The variable speed controller, freezestat, and crankcase heater are available through OEM Dealer Service Centers.

The operation of each kit can vary somewhat between cooling and heat pump units. Refer to the low ambient kit for specific information.

Generally, the low ambient kits are wired to accomplish the following: Low pressure switches are installed to sense head pressure and cycle the condenser fan. The fan is cycled in order to keep head pressure high during low ambient operation. Variable speed controllers may require ball bearing fan motors for proper operation at low speed.

If low ambient operation is required and the outdoor unit is exposed to high prevailing winds, a permanent wind barrier should be constructed to protect the outdoor coil. In cooling operation, high prevailing winds can significantly reduce head pressure. In heat pumps, high prevailing winds can reduce the effectiveness of the defrost cycle. Use the minimum installation clearances (provided in Engineering Handbook) as a guide when constructing a wind barrier. Wind barriers should extend vertically to the height of the coil.

Appendix A

HFC-410A REFRIGERANT

The phase out of HCFC-22 refrigerant is currently underway in the U.S. The official deadline for all equipment manufacturers to change over to more environmentally friendly refrigerants is 2010. Aftermarket HCFC-22 will be available until 2020. HFC-410A is quickly becoming the refrigerant of choice to replace HCFC-22 in residential and light commercial air conditioning equipment.

HFC-410A is a near-azeotropic mixture of R-32 and R-125 refrigerants. HFC-410A operates at 50% higher pressure than HCFC-22. Due to the higher pressure, OEM has upgraded system components in HFC-410A systems. HFC-410A must not be used to retrofit existing HCFC-22 equipment. HFC-410A can only be used in equipment designed for HFC-410A.

Operating pressure points are different for HCFC-22 and HFC-410A:

Table 12. Head Pressures

50F Evaporator / 115F Condenser	HCFC-22	HFC-410A
Suction Pressure	84 psig	143 psig
Head Pressure	243 psig	390 psig

Table 13. Recommended Hose Pressure Capabilities.

High-pressure Hoses	Minimum 700-psig service pressure rating
High-pressure manifold gauge sets	700 psig on the high side Minimum 180 psig low side 550-psig low-sided retard
High-pressure recovery units	See manufacturer's recommendations.
High-pressure recovery tanks	The recovery cylinder service pressure rating must be 400 psig, DOT 4BA400, or DOT 4BW400.

Proper joint brazing and maintenance becomes even more critical with HFC-410A. When servicing HFC-410A system, the contractor must make sure to use components specifically designed for HFC-410A.

Special service equipment required for working with HFC-410A includes:

It is recommended that charging with HFC-410A be done in the liquid phase. Use a commercial-type metering device in the manifold hose. Charge into the suction line with the compressor running. See OEM installation instructions for more details on proper charging procedures.

HFC-410A systems use POE oils. POE oils absorb moisture very quickly. Keep oil containers tightly closed. Expose the system to atmosphere as little as possible.

The filter driers uses with HFC-410A systems are designed with higher working pressures and desiccant materials that are compatible with POE oils and HFC refrigerants. Change the filter drier anytime the system is opened to the atmosphere.

HFC-410A systems manufactured by OEM are either expansion valve systems or fixed orifice. Proper refrigerant charge for TXV systems should be checked by the approach method. Proper refrigerant charge for orifice systems should be checked by the subcooling method.

The maximum liquid line pressure drop in HFC-410A systems is 35 PSI, which equates to six degrees of subcooling. The recommended suction line pressure drop is five PSI, which equates to two degrees of saturated suction temperature.



PIPING INSTALLATION

Refrigerant lines must not transmit equipment vibration to any part of the structure. Lines should be supported by isolation hangers. See figure 20. In no case should refrigeration lines be left unsupported and free to touch the structure at any point. Where lines pass through roofs, walls, floors or sills, or where they come in contact with duct

work, they should be properly isolated. If outside, the isolation material should be properly waterproofed.

The piping must be supported securely at the proper places. All piping should be supported with hangers that can withstand the combined weight of pipe, fittings, refrigerant and insulation. The hangers must be able to keep the pipe in proper alignment, thus preventing any droop.

LINE SET

IMPORTANT — Refrigerant lines must not contact structure.

INSTALLATION

Line Set Isolation — The following illustrations are examples of proper refrigerant line set isolation:

REFRIGERANT LINE SET — TRANSITION FROM VERTICAL TO HORIZONTAL

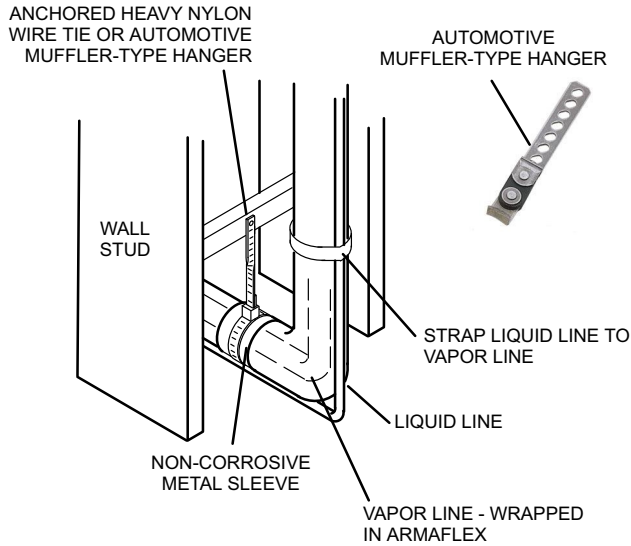

REFRIGERANT LINE SET — INSTALLING VERTICAL RUNS (NEW CONSTRUCTION SHOWN)

NOTE — Insulate liquid line when it is routed through areas where the surrounding ambient temperature could become higher than the temperature of the liquid line or when pressure drop is equal to or greater than 20 psig.

IMPORTANT — Refrigerant lines must not contact wall

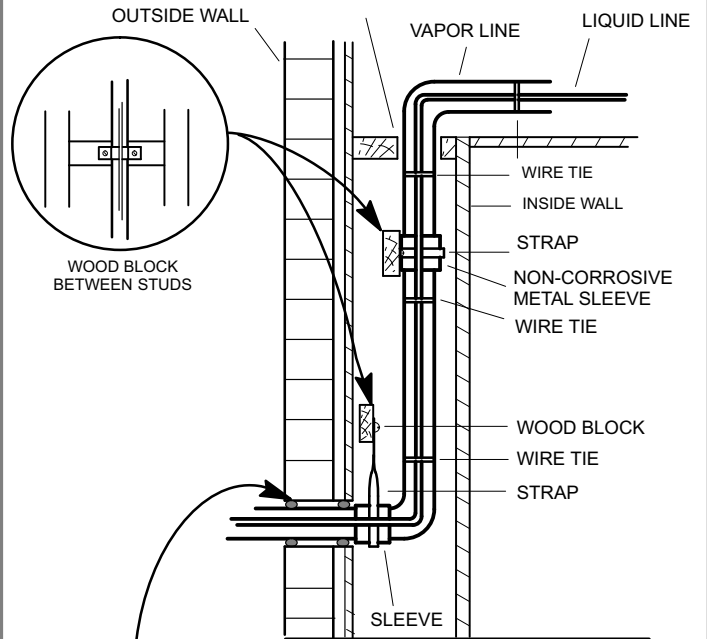

REFRIGERANT LINE SET — INSTALLING HORIZONTAL RUNS

To hang line set from joist or rafter, use either metal strapping material or anchored heavy nylon wire ties.

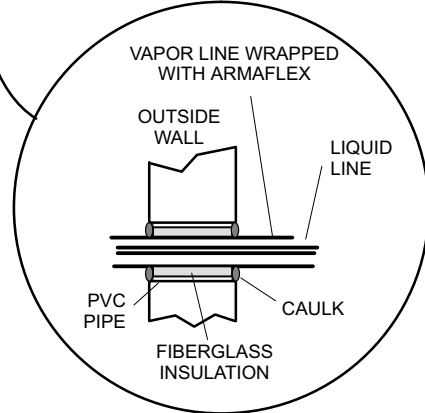
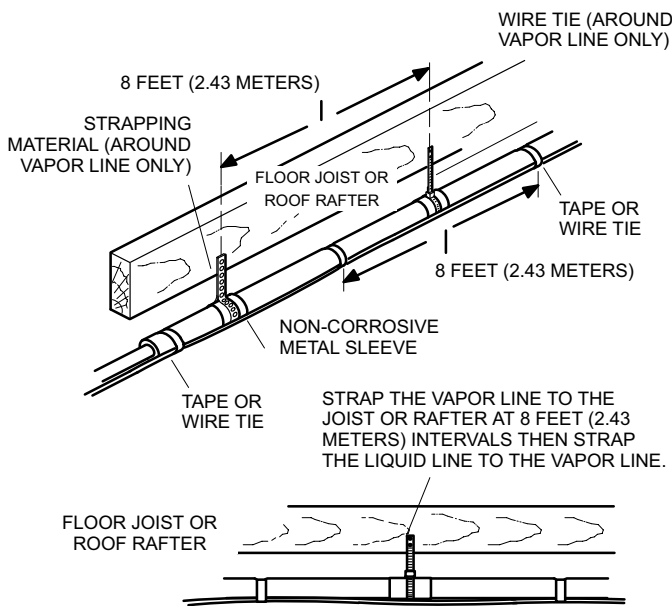

NOTE — Similar installation practices should be used if line set is to be installed on exterior of outside wall.

WARNING — Polyol ester (POE) oils used with HFC-410A refrigerant absorb moisture very quickly. It is very important that the refrigerant system be kept closed as much as possible. DO NOT remove line set caps or service valve stub caps until you are ready to make connections.

Figure 20. Line Set Installation



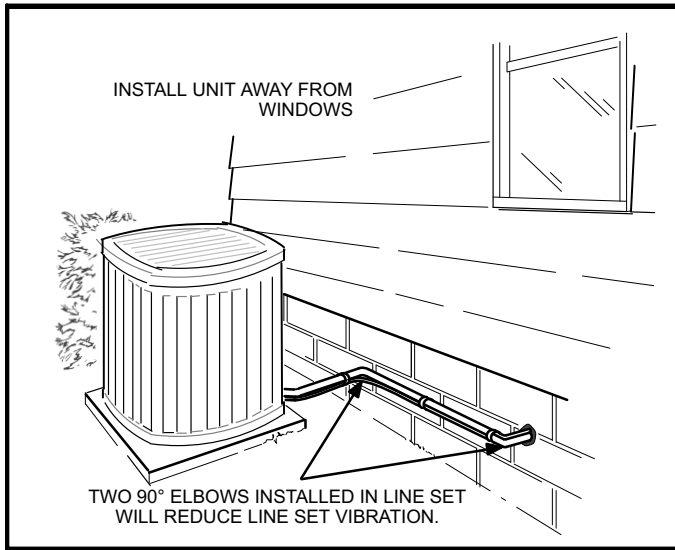

Figure 21. Outside Unit Placement

COMPLEX LIQUID LINE SIZING

Example 1 – Liquid Sizing with Multiple Evaporators

Occasionally, more than one evaporator may be connected to one condensing unit. The line sizing method shown here is for a system with multiple evaporators operating simultaneously.

In this example, all the evaporators are located above the condensing unit. All evaporators experience the effects of liquid lift. The system is equipped with a 2-ton, 5-ton and 3-ton evaporator in order from top to bottom.

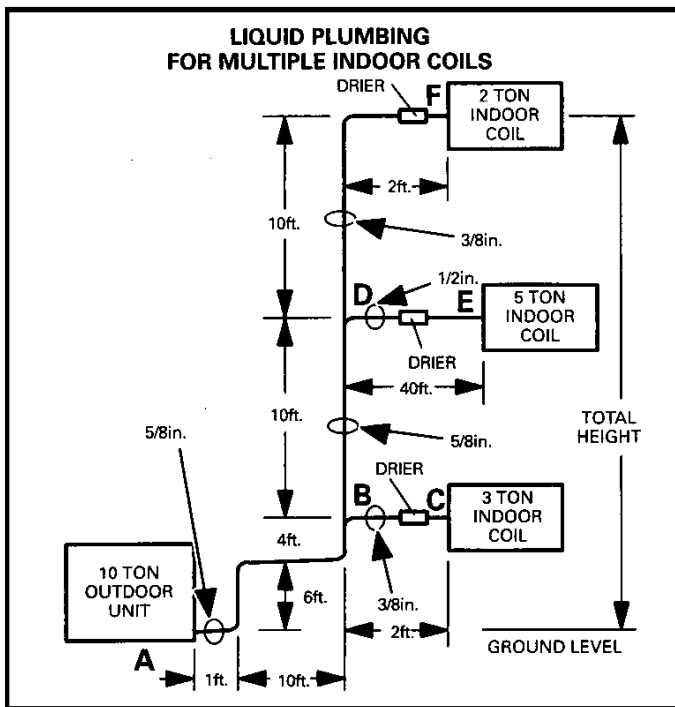

Figure 22. Liquid Plumbing

Given: Ten ton commercial (single stage) condensing unit on ground with three evaporators above condenser. See figure 22.

Find: Select tube size from figure 8.

Solution: Size each segment based on the tons of refrigerant that will flow in the segment.

Segment A to B

First solve segment A to B (10 tons). Figure 8 indicates that, for a 10-ton system, 5/8 inch outside diameter. Liquid line should be selected (smallest liquid line with acceptable velocity). Figure 4 also indicates that 5/8 inch line carrying 10 tons of capacity has 4.3 psi drop per 100 feet. Then determine the equivalent length of the segment to calculate the pressure drop.

Twenty one feet of pipe, plus three 90° elbows (one equivalent foot each, from table 4), plus one tee (line side of tee at 0.8 equivalent feet each, from table 4) = 24.8 equivalent feet length (round up to 25 equivalent feet).

When we multiply 4.3/100 by 25 equivalent feet, we see that the total friction loss is 1.1 psi.

Now, we must add the pressure drop for vertical lift. HCFC-22 pressure drop is 1/2 psi per foot of vertical lift. When multiplied by 10 feet vertical lift we find that pressure drop due to lift = five psi.

When the two components of pressure drop are added together we find that the total pressure drop in this 5/8 inch line = 6.1 psi.

Segment B to C

B to C has a capacity of three tons. Figure 4 indicates a three ton system should use 3/8 inch outside diameter. line (smallest line with acceptable velocity). Now, determine the equivalent length of the segment to calculate the pressure drop.

Two feet of pipe, plus one tee (branch side of tee at 1.5 equivalent feet each) = 3.5 equivalent feet length (round up to four equivalent feet).

From figure 4, 3/8 inch outside diameter. liquid line with three tons capacity has 8.3 psi drop per 100 feet. When we multiply 8.3/100 by four equivalent feet, we see that the total friction loss is 0.33 psi.

Vertical lift = 0.

In this segment, the only component of pressure drop is the equivalent length; 0.33 psi.

Segment B to D

B to D has a capacity of seven tons. Select from figure 4 a 5/8 inch outside diameter. line (smallest line with acceptable velocity). Then determine the equivalent length of the segment to calculate the pressure drop.

10 feet of pipe, plus one tee (line side of tee at 0.8 equivalent feet) = 10.8 equivalent feet length (round up to 11 equivalent feet).

From figure 4, 5/8 inch outside diameter. liquid line with 7 tons capacity has 2.3 psi drop per 100 feet. When we multiply 2.3/100 by 11 equivalent feet, we see that the total friction loss is 0.25 psi.

Now, we must add the pressure drop for vertical lift. HCFC-22 pressure drop is 1/2 psi per foot of vertical lift. When multiplied by 10 feet vertical lift we find that pressure drop due to lift = five psi.

When the components of pressure drop are added together we find that the total pressure drop in this 5/8 inch line = 5.25 psi.

Segment D to E

- D to E has a capacity of five tons. Select from figure 4 a 1/2 inch outside diameter. line (smallest line with acceptable velocity). Then determine the equivalent length of the segment to calculate the pressure drop.
- Forty feet of pipe, plus one tee (branch side of tee at 2.0 equivalent feet each) = 42 equivalent feet length.
- From figure 4, 1/2 inch outside diameter. liquid line with five tons capacity has 4.6 psi drop per 100 feet. When we multiply 4.6/100 by 42 equivalent feet, we see that the total friction loss is 1.93 psi.
- Vertical lift = 0.
- In this segment, the only component of pressure drop is the equivalent length; 1.93 psi.

Segment D to F

- D to F has a capacity of two tons. Select from figure 4 a 3/8 inch outside diameter. line (smallest line with acceptable velocity). Then determine the equivalent length of the segment to calculate the pressure drop.
- Twelve feet of pipe, plus one 90° elbow (0.8 equivalent feet each) = 12.8 equivalent feet length (round up to 13 equivalent feet).
- From figure 4, 3/8 inch outside diameter. liquid line with 2 tons capacity has four psi drop per 100 feet. When we multiply 4/100 by 13 equivalent feet, we see that the total friction loss is 0.52 psi.
- Now, we must add the pressure drop for vertical lift. HCFC-22 pressure drop is 1/2 psi per foot of vertical lift. When multiplied by 10 feet vertical lift we find that pressure drop due to lift = five psi.
- When the components of pressure drop are added together we find that the total pressure drop in this 3/8 inch line = 5.52 psi.

Putting the Segments Together

Next, we must determine if the line sizes we selected will result in satisfactory pressure drop between the condensing unit and each evaporator. To do this we simply add the total pressure drop of each line segment between the condensing unit and each evaporator. Remember the total pressure drop between the condensing unit and evaporator should be less than 30 psi.

- Total pressure drop A to C = A to B plus B to C.
- Total pressure drop = 6 + 0.33 = 6.33 (Acceptable).
- Total pressure drop A to E = A to B plus B to D plus B to C.
- Total pressure drop = 6 + 5.25 + 1.93 = 6.33 (Acceptable).
- Total pressure drop A to F = A to B plus B to D plus D to F.
- Total pressure drop = 6 + 5.25 + 5.52 = 16.77 (Acceptable).

Complex Suction Line Sizing

When a single condenser is connected to more than one evaporator, there are additional rules which must be followed when designing the refrigerant piping. These rules apply to separate coils in separate air handlers as well as to split coils in a single air handler.

First, the total evaporator load must at least equal the condensing unit capacity. Next, when evaporators in different levels are connected to a single main, the suction line from each coil must rise to the top of that coil before joining the main. Finally, all connections to a suction main must loop over and enter the top of the main to avoid the gravity draining of oil into the suction risers during off cycles.

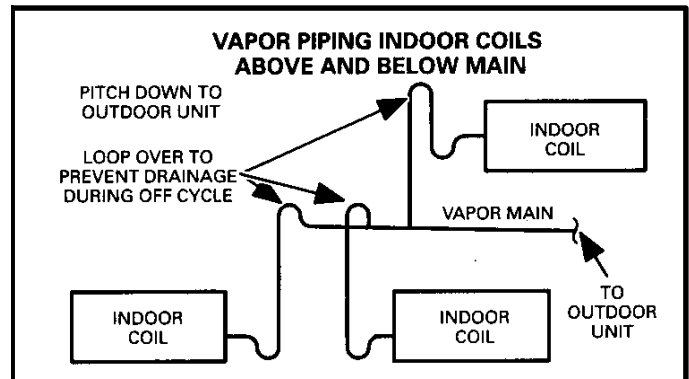

Figure 23. Vapor Piping Indoor Coils above and below Main

Example 2 – Suction Sizing with Multiple Evaporators

On systems with multiple evaporators operating simultaneously connected to a single condensing unit, suction lines are sized similar to the method used for sizing liquid lines. Each line segment is sized based on the tons of refrigerant flowing in the segment.

In this example, all the evaporators are located above the condensing unit so that none of the evaporators experience the effects of suction lift. The system is equipped with a 2 ton, 5 ton and 3 ton evaporator in order from top to bottom.

Given: 10 ton condensing unit with three evaporators, higher than condenser, operating simultaneously.

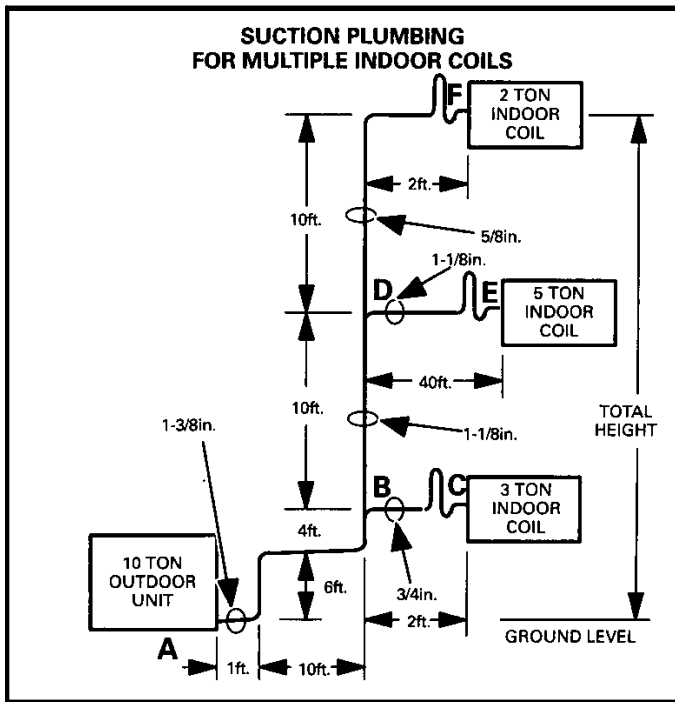

Figure 24. Suction Plumbing for Multiple Indoor Coils

Find: Select tube size from figure 6.

Solution: Size each segment based on the tons of refrigerant that will flow in the segment.

Segment A to B

First solve segment A to B (10 tons). Select from figure 5 a 1-3/8 inch outside diameter. line (smallest suction line with acceptable velocity). Then determine the equivalent length of the segment to calculate the pressure drop.

21 feet of pipe, plus three 90° elbows (2.4 equivalent feet each), plus one tee (line side of tee at 1.8 equivalent feet each) = 30 equivalent feet length.

From figure 6, 1-3/8 inch outside diameter. suction line with 10 tons capacity has 3.3 psi drop per 100 feet. When we multiply 3.3/100 by 30 equivalent feet, we see that the total friction loss is 0.99 psi.

Vertical lift or drop has no effect on pressure in a vapor line.

Segment B to C

B to C has a capacity of three tons. Select from figure 8 a 3/4 inch outside diameter. line (smallest line with acceptable velocity yet with minimum capacity loss). Note figure 8 shows that 3/4 inch line has significant pressure drop per 100 feet when combined with 3-ton capacity. If segment B to C were much longer, the pressure drop would significantly reduce capacity and a larger (7/8 inch) line would have to be selected.

Determine the equivalent length of the segment to calculate the pressure drop.

Two feet of pipe, plus one tee (branch side of tee at 3.5 equivalent feet each), plus six ells (1.25 equivalent feet each) = 13 equivalent feet length.

From figure 8, 3/4 inch outside diameter. suction line with three tons capacity has 8.5 psi drop per 100 feet. When we multiply 8.5/100 by 13 equivalent feet, we see that the total friction loss is 1.11 psi.

Segment B to D

B to D has a capacity of seven tons. Select from figure 8 a 1-1/8 inch outside diameter. line (smallest line with acceptable velocity). Then determine the equivalent length of the segment to calculate the pressure drop.

Ten feet of pipe, plus one tee (line side of tee at 1.5 equivalent feet each) = 11.5 equivalent feet length.

From figure 8, 1-1/8 inch outside diameter. suction line with seven tons capacity has 5.2 psi drop per 100 feet. When we multiply 5.2/100 by 11.5 equivalent feet, we see that the total friction loss is 0.6 psi.

Segment D to E

D to E has a capacity of five tons. Select from figure 8 a 1-1/8 inch outside diameter. line (smallest line with acceptable velocity). Then determine the equivalent length of the segment to calculate the pressure drop.

Forty feet of pipe, plus one tee (branch side of tee at 4.5 equivalent feet each), plus six elbows (1.8 equivalent feet each) = 55.3 equivalent feet length.

From figure 8, 1-1/8 inch outside diameter. suction line with 5 tons capacity has 2.8 psi drop per 100 feet. When we multiply 2.8/100 by 44.5 equivalent feet, we see that the total friction loss is 1.55 psi.

Segment D to F

D to F has a capacity of two tons. Select from figure 8 a 5/8 inch outside diameter. line (smallest line with acceptable velocity). Then determine the equivalent length of the segment to calculate the pressure drop.

12 feet of pipe, plus seven 90° elbow (1.3 equivalent feet each) = 21.1 equivalent feet length.

From figure 8, 5/8 inch outside diameter. suction line with two tons capacity has 12 psi drop per 100 feet. When we multiply 12/100 by 21.1 equivalent feet, we see that the total friction loss is 2.53 psi. Here also, the pressure drop and resulting capacity loss are approaching significant levels.

It might be more appropriate to select 3/4 inch line in order to limit the losses. Equivalent length now equals 20.75 feet. From figure 8, 3/4 inch outside diameter. suction line with two tons capacity has 4.2 psi drop per 100 feet. When we multiply 4.2/100 by 20.75 equivalent feet, we see that the total friction loss is only 0.87 psi.

RFCII REFRIGERANT FLOW CONTROL DEVICE

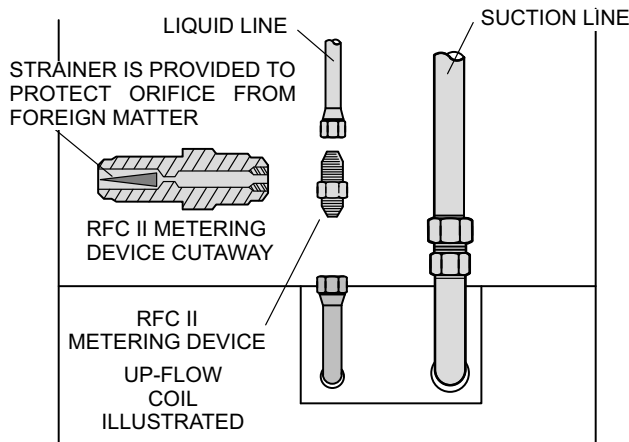

THERMOSTATIC EXPANSION VALVE (Air Conditioning System Shown)

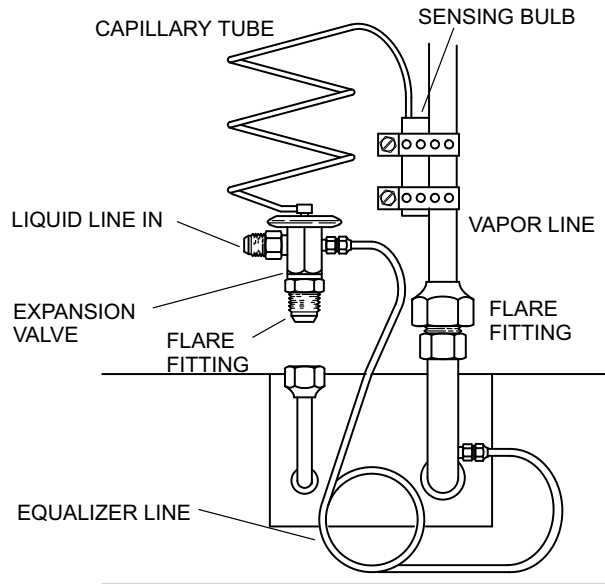

RFCIII REFRIGERANT FLOW CONTROL DEVICE

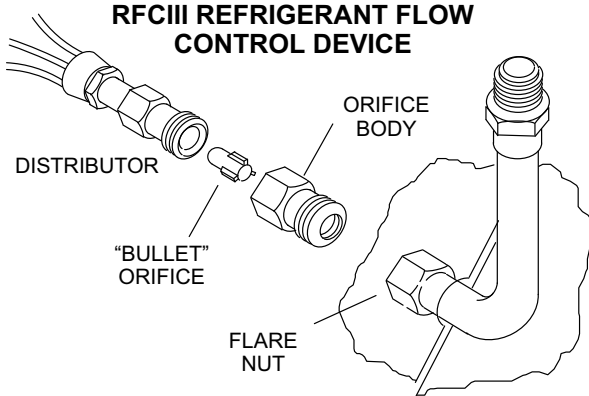

RFCIV REFRIGERANT FLOW CONTROL DEVICE

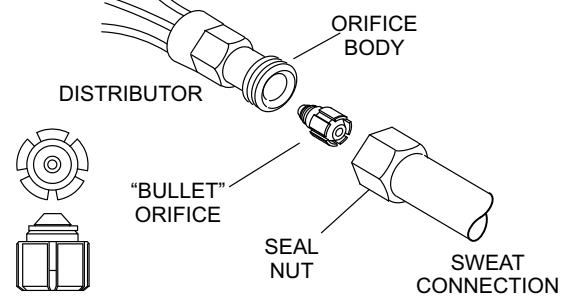

RFCIII REFRIGERANT FLOW CONTROL DEVICE

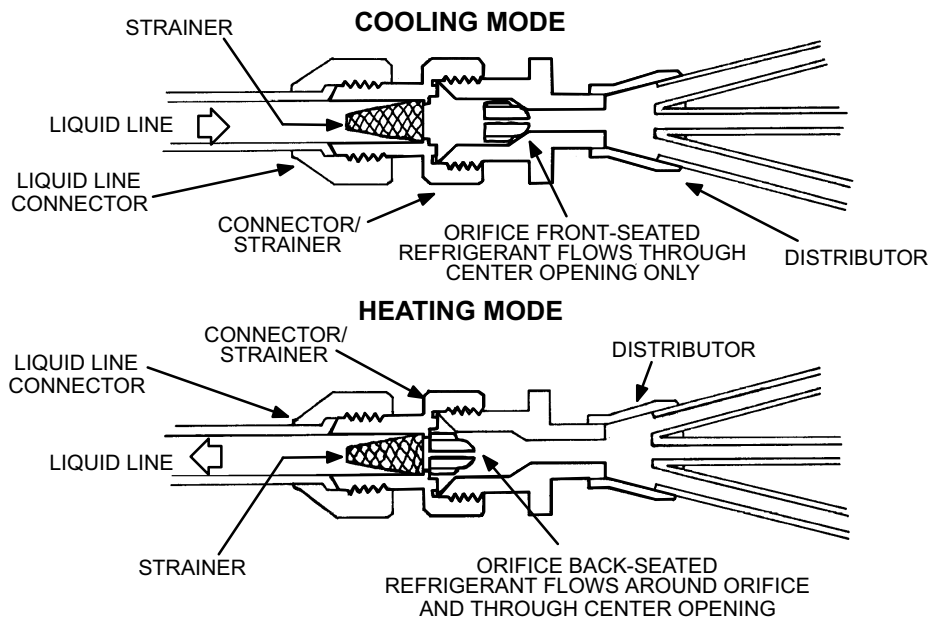

Figure 25. Metering Devices



Putting the Segments Together

Next, we must determine if the line sizes we selected will result in satisfactory pressure drop between the condensing unit and each evaporator. To do this we simply add the total pressure drop of each line segment between the condensing unit and each evaporator. Then we convert the pressure drop into a capacity loss for each coil. Remember, there is approximately 1% loss in capacity for each pound of pressure lost to the line.

2-ton evaporator:

- Total pressure drop A to F = A to B plus B to D plus D to F.
- If 5/8 inch outside diameter line is used from D to F:
- Total pressure drop = $0.99 + 0.6 + 2.53 = 4.12$
- If 3/4 inch outside diameter line is used from D to F:
- Total pressure drop = $0.99 + 0.6 + 0.87 = 2.46$
- 1% capacity loss for each pound pressure drop
- $0.01 \times 2.46 \times 24,000 = 590$ Btuh lost if 3/4 inch line is used.
- $0.01 \times 4.12 \times 24,000 = 989$ Btuh lost if 5/8 inch line is used.

3-ton evaporator:

- Total pressure drop A to C = A to B plus B to C.
- Total pressure drop = $0.99 + 1.11 = 2.1$ psi
- 1% capacity loss for each pound pressure drop
- $0.01 \times 2.1 \times 36,000$ Btuh = 756 Btuh lost.

5-ton evaporator:

- Total pressure drop A to E = A to B plus B to D plus D to E.
- Total pressure drop = $0.99 + 0.6 + 1.55 = 3.14$ psi
- 1% capacity loss for each pound pressure drop
- $0.01 \times 3.14 \times 60,000$ Btuh = 1884 Btuh lost.

When deciding which line should be used from D to F, compare the capacity loss to the capacity required. Use the larger line size only if the additional capacity is needed to satisfy the job requirements.

If the line segments to these evaporators were significantly longer resulting in excessive capacity loss, larger suction lines could be selected as long as satisfactory velocities for oil entrainment were maintained.

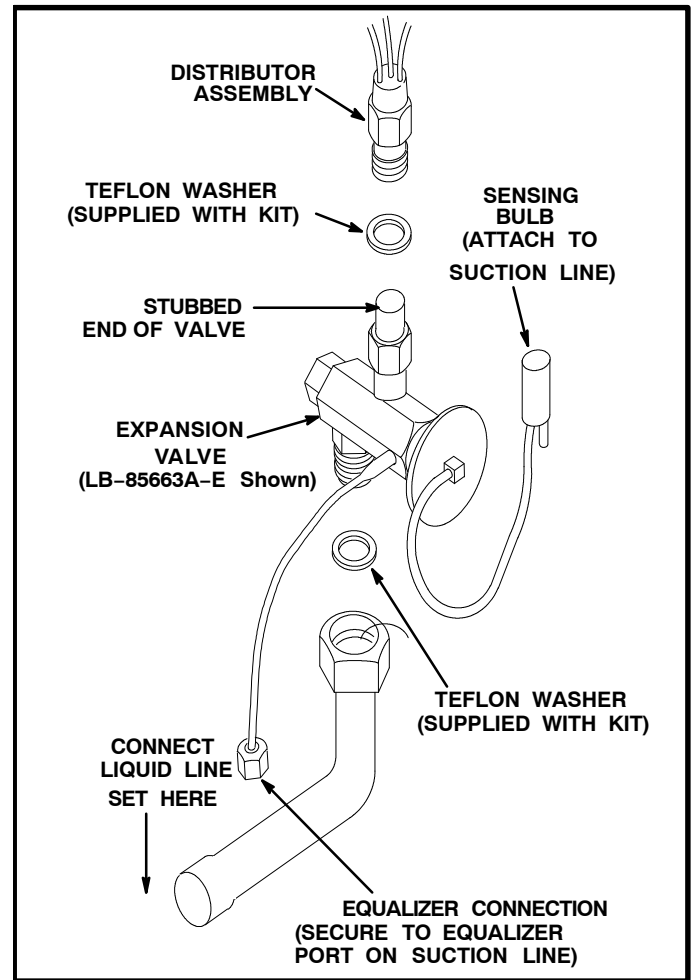

Figure 26. Typical Residential Applications

Table 14. Operating Temperatures

HCFC-22 Temperature (°F) - Pressure (Psig)							
°F	Psig	°F	Psig	°F	Psig	°F	Psig
-40	0.6	22	45.5	50	84.7	105	212.9
-30	0.9	24	47.9	55	93.3	110	228.6
-20	10.2	26	50.3	60	102.4	115	245.2
-10	16.6	28	52.7	65	112.2	120	262.5
0	24.1	30	55.2	70	122.5	125	280.7
10	32.9	32	57.8	75	133.4	130	299.7
12	34.9	34	60.5	80	145.0	135	319.6
14	36.9	36	63.3	85	157.2	140	340.3
16	39.0	38	66.1	90	170.0	145	362.0
18	41.1	40	69.0	95	183.6	150	384.6
20	43.3	45	76.6	100	197.0	155	406.3

Table 15. Operating Temperatures

HFC-410A Temperature (°F) - Pressure (Psig)							
°F	Psig	°F	Psig	°F	Psig	°F	Psig
32	100.8	64	181.6	96	299.4	126	451.8
34	105.0	66	187.7	98	308.2	128	463.5
36	109.2	68	194.1	100	317.2	130	475.6
38	113.6	70	200.6	102	326.4	132	487.8
40	118.0	72	207.2	104	335.7	134	500.2
42	122.6	74	214.0	106	345.3	136	512.9
44	127.3	76	220.9	108	355.0	138	525.8
46	132.2	78	228.0	110	365.0	140	539.0
48	137.1	80	235.3	112	375.1	142	552.3
50	142.2	82	242.7	114	385.4	144	565.9
52	147.4	84	250.3	116	396.0	146	579.8
54	152.8	86	258.0	118	406.7	148	593.8
56	158.2	88	266.0	120	417.7	150	608.1
58	163.9	90	274.1	122	428.8	152	622.7
60	169.6	92	282.3	124	440.2	154	637.5
62	195.5	94	290.8	126	451.8	156	652.4

Appendix B — XC25 / XP25 Line Set Requirements

The XC/XP25 is a variable capacity cooling and heat pump system utilizing variable speed compressor technology. With the variable speed compressor and variable pumping capacity, additional consideration must be given to refrigerant piping sizing and application. The guidelines below are to be used exclusively for the XC/XP25 systems.

COOLING AND HEAT PUMP SYSTEMS (HFC-410A)

- Total equivalent length equals 180 feet (piping and all fittings included).

NOTE — Length is general guide. Lengths may be more or less, depending on remaining system design factors.

- Maximum linear (actual) length = 150 feet.
- Maximum linear liquid lift = 60 feet.

NOTE — Maximum lifts are dependent on total length, number of elbows, etc. that contribute to total pressure drop.

- Maximum length vapor riser equals 60 feet.

- Vertical vapor riser must be sized to the vapor riser listed in the table 16.
- Up to 50 Linear Feet:** use rated line sizes listed in unit specifications or installation instructions.
- Between 51 - 150 Linear Feet:** Crankcase heater and non-bleed port TXV factory installed. No additional components required. Use tables 16 and 17 to determine the correct liquid and vapor line sizes.
- Over 150 Linear Feet:** not recommended.
- Additional oil is not required for systems with line lengths up to 150 feet except for the XP25-048 and XP35-060, which will required 2 ounces of oil for every 10 feet beyond 100 feet.

SUCTION TRAPS

For systems with the outdoor unit 5 - 60 feet above the indoor unit, one trap must be installed at the bottom of the suction riser.

Table 16. XC/XP25 Piping Guidelines

Model	Maximum Total Equivalent Length (ft)	Maximum Linear (actual) Length (ft)	Maximum Vapor Riser (ft)	Maximum Linear Liquid Lift (ft)	Preferred Vapor Line Sizes for Horizontal Runs	Required Vapor Riser Size
-024	180	150	60	60	7/8"	5/8"
-036	180	150	60	60	7/8"	3/4"
-048	180	150	60	60	7/8"	7/8"
-060	180	150	60	60	7/8"	7/8"

Table 17. Liquid Line Diameter Selection Table

Unit	Line Size	Total Linear Length (feet)						Max. Elevation (ft)
		25	50	75	100	125	150	
-024	5/16"	25	50	55	48	40	33	
	3/8"	25	50	60	60	60	60	
-036	3/8"	25	50	60	56	51	45	
	1/2"	25	50	60	60	60	60	
-048	3/8"	25	50	50	41	31	22	
	1/2"	25	50	60	60	60	60	
-060	3/8"	25	50	36	22	8	NR	
	1/2"	25	50	60	60	60	59	

Note - Shaded rows indicate rated liquid line size

- Find your unit on the left side of the table.
- Start with the rated liquid line size (shaded row) on the outdoor unit
- Select the actual Total Linear Length of your system shown at the top of the table.
- The elevation listed in the table is the maximum allowed for the liquid line listed.
- Select or consider the larger liquid line size shown in the table if the elevation does not meet your requirements.

Glossary of Terms

accumulator A tank located in the suction line just ahead of the compressor. The purpose of the accumulator is to prevent liquid from entering the compressor.

ambient The temperature of the air surrounding an object. For a liquid line passing through an attic, the ambient can approach 180°F. OEM cooling and heat pump equipment is designed to provide adequate cooling when the outdoor ambient is 115°F.

bypass See Hot Gas Bypass.

bypass valve A valve used in hot gas bypass systems. The valve is plumbed so that when the unit is operating at reduced capacity, liquid refrigerant and hot gas are metered into the suction line. See also Hot Gas Bypass.

capillary tube (cap tube) Refrigerant metering device consisting of one or more small diameter tubes feeding liquid refrigerant into the evaporator. Cap tubes must never be used in long refrigerant line applications as they provide fair to poor refrigerant control in extreme conditions.

capacity (capacity loss) A measure of the quantity of refrigeration available, measured in Btu per hour or watts.

capacity reduction Air conditioning and heat pump systems designed to operate at reduced capacity. OEM two stage equipment is designed to operate at 60% of full capacity during low stage operation. Some commercial systems use hot gas bypass as a form of capacity reduction. A form of capacity reduction is used in almost all zoning systems.

column of liquid A length of liquid refrigeration line completely filled with 100% liquid (no bubbles).

condenser A heat transfer device which removes heat from refrigerant gas, reduces its temperature, removes latent heat from the refrigerant converting the gas into liquid, then subcools the liquid.

condensing temperature The temperature in the condenser coil below which latent heat is removed and gas is converted into liquid.

distributor A manifold or multi-port fitting located at the outlet of an expansion valve designed to feed multiple circuits through the evaporator.

double suction riser A type of suction riser used in capacity reduction systems to improve oil entrainment during reduced capacity operation. A double suction riser consists of a small riser sized for the capacity of the system when operating at reduced capacity. A second larger riser is plumbed in parallel with the small riser to handle the increased flow when the system is operating at full capacity.

drier See Filter Drier.

drop 1) A measure of the downward vertical distance (measured in feet) liquid refrigerant must travel in order to reach the coil. The weight of the liquid refrigerant increases the liquid line pressure 1/2 pound per foot. 2) See pressure drop.

elbow Wrought copper 90° or 45° elbows. Only long radius elbows should be used as fittings in long refrigerant lines used with OEM equipment.

entrainment The process of moving oil along the inside surface of a refrigerant vapor line. Oil droplets/film attach to the inner surface of the pipe. The refrigerant velocity must be sufficient to sweep the oil along (entrain the oil) so it may be returned to the compressor.

expansion valve See Thermostatic Expansion Valve.

equivalent length (total equivalent length) Wrought copper fittings, filter driers and other devices placed in the refrigerant line add restriction to the line. The restriction added to the line is expressed in terms of equivalent feet. The total equivalent length of a line is equal to the length of the pipe plus the equivalent length of all the fittings, filter driers, etc. placed in the line.

evaporator A heat transfer device (coil) which adds heat to liquid refrigerant, increases its temperature, adds latent heat to the refrigerant converting the liquid into gas, then superheats the gas.

filter drier A device placed in the liquid or suction refrigerant lines to filter contaminants from the system and protect the expansion valve and compressor from potential damage.

flash gas in a liquid refrigerant line, liquid which has lost temperature and pressure to the point that gas bubbles begin to form significantly reducing the efficiency of the system. Flash gas can form as a result of friction losses or running the liquid line through areas with extremely high ambients or both.

friction loss See Pressure Drop.

hammer See Liquid Hammer.

hot gas bypass A form of capacity reduction. The system diverts hot discharge gas and liquid into the suction line bypassing the evaporator coil. The most desirable form of hot gas bypass is the type which feeds hot gas into a side tap on the distributor on the evaporator coil.

indoor coil The name given to the coil in the indoor unit in heat pump systems.

lift A measure of the upward vertical distance liquid refrigerant must travel in order to reach the coil measured in feet. The weight of the liquid refrigerant reduces the liquid line pressure 1/2 psi per foot. In air conditioning systems, lift is a factor only if the evaporator is located above the condenser. In heat pump systems, lift is always a factor due to the system's ability to reverse refrigerant flow.

line size The outside diameter (O.D.) of copper pipe used in refrigeration.

liquid hammer An audible sound heard in liquid refrigerant lines when solenoid valves close. The noise is a result of liquid refrigerant traveling at high velocity then stopping abruptly when the valve closes.

low ambient (temperature) The use of the compressor for cooling when outdoor temperature is below 50°F. Field installed kits are required to protect the compressor and ensure proper operation in the event low ambient cooling below 50° F is required.

main In systems with multiple refrigerant lines, the name given to the line which feeds or collects refrigerant from multiple smaller refrigerant lines.

maximum allowable pressure drop The amount of pressure drop a liquid line can experience before flash gas will begin to form. This number can be calculated if the amount of sub-cooling leaving the condenser is known by subtracting the liquid temperature from the saturated liquid temperature then converting the results into a pressure on the HCFC-22 saturation chart. The difference in pressure between saturated liquid temperature and the liquid temperature is equal to the maximum allowable pressure drop.

If the outdoor unit is charged to operate with 10°F subcooling at 115°F saturated liquid temperature, the maximum allowable pressure drop will be 30 psi.

metering (metering device) Any device which regulates the flow of liquid refrigerant into an evaporator.

migrate (migration) The tendency of refrigerant gas to slowly travel to the coldest part of the piping system during the off-cycle and condense and collect as liquid.

miscibility The ability of two or more substances to mix, and form a single homogeneous phase.

multiple evaporators A single condenser operating with several evaporators at the same time.

non-recycling pump-down control See Pump Down Control.

oil trap A small U bend typically located in the suction line where it exits the indoor coil. Short radius elbows should be used on oil traps to keep the oil volume as small as possible.

outdoor coil The name given to the coil in the outdoor unit in heat pump systems.

pressure drop (pressure loss) The loss of refrigerant pressure experienced in copper pipe, usually expressed in terms of pounds (psi) per 100 feet.

pump-down control A field installed kit consisting of a solenoid valve located in the liquid line before the expansion valve. At the end of a cooling cycle, the controls close the valve. The compressor continues to run until all refrigerant is returned into the condenser where it is stored as a liquid. The valve remains closed until the next cooling demand.

RFC (refrigerant flow control device) OEM' trademark protected name for various types of refrigerant metering devices with fixed orifice size -

RFC: Liquid line serves as the expansion device. It has a precisely sized inside diameter and length which matches the capacity of the condensing unit and evaporator.

RFCII: Fixed orifice for air conditioners located at evaporator.

RFCIII: Floating bullet type orifice for heat pump coils which front seats for cooling and back seats for heating

RFCIV: Fixed bullet orifice for air conditioners.

riser The name of any length of refrigerant pipe which transports refrigerant vertically upward.

run-around hot gas bypass A type of hot gas bypass system that diverts hot discharge gas and liquid directly into the suction line inside the condensing unit. Although this type of system requires no piping external to the unit, it is less desirable than feeding into a side tap on the distributor on the evaporator coil.

saturation temperature The temperature at which a gas begins to turn into liquid.

sight glass A glass window type device placed in a liquid line and used for visual inspection of the liquid. It can also be used to determine the point at which all gas bubbles are removed from the liquid line. A sight glass is not a good indicator of subcooling and cannot be used to determine charge.

sil-phos Brazing material composed of silver, phosphorous, and copper and used for brazing joints of copper pipe.

slug A column of liquid refrigerant returned to the compressor in the suction line. A slug which enters the compressor can cause permanent compressor damage due to non-compressibility of liquids.

solenoid valve An electromechanical valve located in the refrigerant lines and used to shut-off refrigerant flow.

split-coil A single evaporator or condenser coil which is plumbed so that a single coil can serve two or more independent refrigeration circuits.

subcooling Cooling of refrigerant liquid below its saturated temperature while holding it at saturated pressure.

suction riser See Riser.

superheat Heating of refrigerant gas above its saturated temperature while holding it at saturated pressure.

thermometer well A device located in the liquid line of most OEM equipment which allows a thermometer to be inserted into the liquid line. The well is used for accurately measuring the temperature of the liquid line for charging purposes.

thermostatic expansion valve (TXV) An extremely precise type of expansion device which regulates refrigerant flow into the evaporator based on the amount of superheat at the TXV bulb location. An expansion valve is desirable in long line set applications because it can maintain control of superheat in extremes of operating conditions.

trap See Oil Trap.

two stage Condensing (or heat pump) outdoor units equipped with a two stage compressor. Generally, the compressor operates at 60% capacity on low stage and 100% capacity on high stage.

TXV See Thermostatic Expansion Valve.

unload (unloading) See Capacity Reduction.

Vapor line Term used with heat pumps to describe the discharge hot gas line in heating mode and the suction line in cooling mode. In either mode the line carries refrigerant in a vapor form.

variable capacity See Capacity Reduction.

velocity A measure of the speed at which refrigerant travels through a pipe, usually expressed in feet per minute.

wrought copper Hammered refrigeration grade copper used in refrigerant fittings.