

PHILIPS



7 series

User manual

Register your product and get support at
www.philips.com/support

Call us:
1-833-978-3323

To obtain assistance, contact Philips customer care center;
In the U.S.A., Canada, Puerto Rico, or the U.S. Virgin Islands

Contents

1 Notice	4	Language	31
Important safety instructions	5	Keyboard	31
2 Getting started	9	Storage	32
What's included	9	Ambient mode (Digital Photo Frame)	32
Installing TV	10	Power & Energy	32
Unpacking and Installing the stands	10	Cast	32
Wall mount	12	System sounds	32
Control Panel & Terminal	12	Retail mode	32
Control panel	12	Restart	32
Terminals	13	Remotes & Accessories	32
Connect devices	13	Pair a Bluetooth device	32
Watch TV	13	Reconnect a paired device	32
Game console/BD/DVD player	14	Fix problems with connecting Bluetooth devices	33
Home theater speaker	15	Troubleshoot connection issues	33
PC screen	15	Help & Feedback	33
Connect devices - Internet router	16	Help	33
		Send feedback	33
3 Completing the first time setup	17	5 Enhance your Google TV	34
Remote	17	Home menu	34
Installing the Batteries	17	Add Google account	34
Buttons	18	Sign in or add an account	34
Talk to Google Assistant	18	Remove or manage accounts	34
Privacy protection built-in	18	Remove your account if you can't use your TV screen	34
Initial set-up	19	Installing apps	35
Plug in and turn on TV	19	Search for an app	35
Follow the on-screen instructions	19	Browse for apps	35
Get started with setup	19	Remove apps	35
Basic TV mode	20	Personalized recommendation	35
Use basic TV on a Google TV device	20	Add your streaming services	35
Switch from basic TV to Google TV	20	Tell us what you like to watch	35
		Manage your watchlist	36
4 Using the On-Screen Menu	21	Mark what you've watched	36
Home menu	21	Rate movies and shows	36
Dashboard	21	Hide recommendations	36
Channels & Inputs	22	Turn on Apps only mode	36
Display & Sound	22	Exit Apps only mode	36
Picture	22	Watch your movies & shows in Apps only mode	36
Sound	23	What happens when Apps only mode is on	36
Audio output	24	Basic TV mode	37
Network & Internet	25	Switch from basic TV to Google TV	37
Accounts & sign-in	26	What you can do in basic TV	37
Google Account	26	What you can't do in basic TV	37
Privacy	27	Live TV/EPG	37
Apps	28	Program Guide	37
Recently Opened Apps	28	Live TV from broadcasting	37
App permissions	28	Choose your favorite channels	37
Special app access	28	Program guide	38
Security & Restrictions	28	Live TV from streaming providers	38
System	29	Pluto TV	38
Accessibility	29	YouTube TV	38
About	31	Sling TV	38
Date & Time	31	Philo	38
		TV options	38
		Kids profile (parental control)	39

Add a kids profile	39	What you can ask Google Assistant	43
Switch to a kids profile	39	USB camera for Google Duo	45
Set up a profile lock	39	How to connect USB camera	45
Allow or block content or apps	40	Stadia gaming	46
Allow or block content in your library based on rating	40	Play Stadia on your TV	46
Set a daily screen time limit	40	Availability	46
Set a daily bedtime	40	Connect a controller to your TV	46
Add bonus time	40	Connect a Bluetooth controller	46
Report inaccurate content ratings	40	Connect a Stadia controller	46
Hide library content	40	Troubleshooting your Stadia experience	46
Unhide library content	40	Google TV, Android TV, or compatible smart TVs	46
Parental Controls	41	Stadia Controller connectivity	47
Use Phone as remote/Watchlist	41	"Please check your connection"	47
Use your phone as your Google TV remote	41		
Set up your virtual remote	41	6 Troubleshooting tips	48
Fix problems with the Google TV virtual remote	41	Basic issues	48
Ambient mode (Digital Photo Frame)	42	Network connections	48
Change the screen saver	42	Connect Remote control	48
Choose your screen saver	42	Video	49
Choose which photos show	42	Audio	50
Customise settings	42	Cable/Satellite TV	51
Show weather & time on your screen saver	42	External devices	51
Cast to Google TV	43	Connect Bluetooth	53
Cast to Google TV	43		
Cast from a device to your TV	43	7 Information	54
Fix problems with casting	43	Glossary	54
Connect your TV and device to the same Wi-Fi network	43	Maintenance	54
Update your TV	43	Specifications	55
Google Assistant	43	Warranty	56
Do more with Google Assistant on Google TV	43	License	57
Talk to Google Assistant	43		

- Displays and illustrations may differ depending on the product you purchase.

1 Notice

Register online at www.philips.com/welcome today to get the most benefits from your purchase.

Registering your model with Philips makes you eligible for all of the valuable benefits listed below, so don't miss out. Register online at www.philips.com/support to ensure:

*Product safety notification

By registering your product, you'll receive notification - directly from the manufacturer - in the rare case of a product recall or safety defect.

*Additional benefits

Registering your product guarantees that you'll receive all of the privileges to which you're entitled, including special money-saving offers.

Know these **safety** symbols



The caution marking is located on the rear or bottom of the cabinet.



The lightning flash with arrowhead symbol, within an equilateral triangle, is intended to alert the user to the presence of uninsulated "dangerous voltage" within the apparatus's enclosure that may be of sufficient magnitude to constitute a risk of electric shock to persons.



The exclamation point within an equilateral triangle is intended to alert the user to the presence of important operating and maintenance (servicing) instructions in the literature accompanying the apparatus.

The symbol for CLASS II or double insulated electrical apparatus. This apparatus has been designed in such a way that it does not require a safety connection to electrical earth.

WARNING: To reduce the risk of fire or electric shock, do not expose this apparatus to rain or moisture. Apparatus shall not be exposed to dripping or splashing and no objects filled with liquids, such as vases, shall be placed on the apparatus.

CAUTION: To prevent electric shock, match wide blade of plug to wide slot, fully insert.

PHILIPS

For fastest support visit us online for chat and self service solutions at www.philips.com/support

CHILD SAFETY:

PROPER TELEVISION PLACEMENT MATTERS

THE CONSUMER ELECTRONICS INDUSTRY CARES

- Manufacturers, retailers and the rest of the consumer electronics industry are committed to making home entertainment safe and enjoyable.
- As you enjoy your television, please note that all televisions – new and old- must be supported on proper stands or installed according to the manufacturer's recommendations. Televisions that are inappropriately situated on dressers, bookcases, shelves, desks, speakers, chests, carts, etc., may fall over, resulting in injury.

TUNE IN TO SAFETY

- **ALWAYS** follow the manufacturer's recommendations for the safe installation of your television.
- **ALWAYS** read and follow all instructions for proper use of your television.
- **NEVER** allow children to climb on or play on the television or the furniture on which the television is placed.
- **NEVER** place the television on furniture that can easily be used as steps, such as a chest of drawers.
- **ALWAYS** install the television where it cannot be pushed, pulled over or knocked down.
- **ALWAYS** route cords and cables connected to the television so that they cannot be tripped over, pulled or grabbed.

CTA.tech/safety

Consumer Technology Association™

WALL OR CEILING MOUNT YOUR TELEVISION

- **ALWAYS** contact your retailer about professional installation if you have any doubts about your ability to safely mount your television.
- **ALWAYS** use a mount that has been recommended by the television manufacturer and has a safety certification by an independent laboratory (such as UL, CSA, ETL).
- **ALWAYS** follow all instructions supplied by the television and mount manufacturers.
- **ALWAYS** make sure that the wall or ceiling where you are mounting the television is appropriate. Some mounts are not designed to be mounted to walls and ceilings with steel studs or cinder block construction. If you are unsure, contact a professional installer.
- Televisions can be heavy. A minimum of two people is required for a wall or ceiling mount installation.

MOVING AN OLDER TELEVISION TO A NEW PLACE IN YOUR HOME

- Many new television buyers move their older CRT televisions into a secondary room after the purchase of a flat-panel television. Special care should be made in the placement of older CRT televisions.
- **ALWAYS** place your older CRT television on furniture that is sturdy and appropriate for its size and weight.
- **NEVER** place your older CRT television on a dresser where children may be tempted to use the drawers to climb.
- **ALWAYS** make sure your older CRT television does not hang over the edge of your furniture.

Important safety instructions

1. Read these instructions.
2. Keep these instructions.
3. Heed all warnings.
4. Follow all instructions.
5. Do not use this apparatus near water.
6. Clean only with dry cloth.
7. Do not block any ventilation openings. Install in accordance with the manufacturer's instructions.
8. Do not install near any heat sources such as radiators, heat registers, stoves, or other apparatus (including amplifiers) that produce heat.
9. Do not defeat the safety purpose of the polarized or grounding-type plug. A polarized plug has two blades with one wider than the other. A grounding type plug has two blades and a third grounding prong. The wide blade or the third prong are provided for your safety. If the provided plug does not fit into your outlet, consult an electrician for replacement of the obsolete outlet.
10. Protect the power cord from being walked on or pinched particularly at plugs, convenience receptacles, and the point where they exit from the apparatus.
11. Only use attachments/accessories specified by the manufacturer.
12. Use only with the cart, stand, tripod, bracket, or table specified by the manufacturer, or sold with the apparatus. When a cart is used, use caution when moving the cart/apparatus combination to avoid injury from tip-over.
13. Unplug this apparatus during lightning storms or when unused for long periods of time.



14. Refer all servicing to qualified service personnel. Servicing is required when the apparatus has been damaged in any way, such as power-supply cord or plug is damaged, liquid has been spilled or objects have fallen into the apparatus, the apparatus has been exposed to rain or moisture, does not operate normally, or has been dropped.

Note to the CATV system installer:

This reminder is provided to call the CATV system installer's attention to Article 820 of the NEC, ANSI/NFPA 70 and Section 54 of the CEC, Part I that provides guidelines for proper grounding and, in particular, specifies that the cable ground shall be connected to the grounding system of the building, as close to the point of cable entry as practical.

Example of antenna grounding as per NEC - National Electric Code

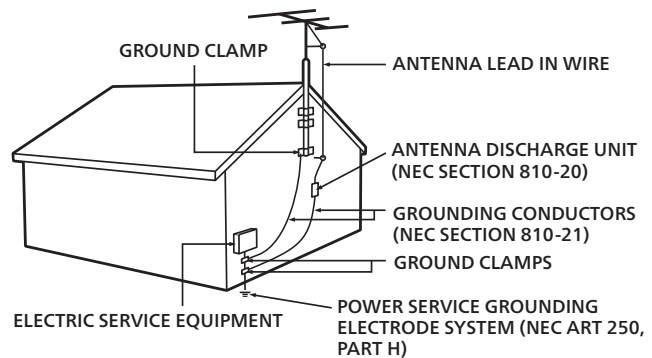

If an outside antenna or cable system is connected to the product, be sure the antenna or cable system is grounded so as to provide some protection against voltage surges and built-up static charges. Article 810 of the NEC, ANSI/NFPA 70 and Section 54 of CEC, Part I provides information with respect to proper grounding of the mast and supporting structure, grounding of the lead in wire to an antenna-discharge unit, size of grounding conductors, location of antenna discharge unit, connection to grounding electrodes, and requirements for the grounding electrode.

Trademarks are the property of Koninklijke Philips N.V. or their respective owners.

Funai Corporation reserves the right to change products at any time without being obliged to adjust earlier supplies accordingly.

The material in this Owner's manual is believed adequate for the intended use of the system. If the product or its individual modules or procedures are used for purposes other than those specified herein, confirmation of their validity and suitability must be obtained. Funai Corporation warrants that the material itself does not infringe any United States patents. No further warranty is expressed or implied.

Funai Corporation cannot be held responsible neither for any errors in the content of this document nor for any problems as a result of the content in this document. Errors reported to Funai Corporation will be adapted and published on the Funai Corporation support website as soon as possible.

Pixel characteristics

This LCD product has a high number of color pixels. Although it has effective pixels of 99.999 % or more, black dots or bright points of light (red, green or blue) may appear constantly on the screen. This is a structural property of the display (within common industry standards) and is not a malfunction.

Warranty

No components are user serviceable. Do not open or remove covers to the inside of the product. Repairs may only be done by service centers and official repair shops. Failure to do so shall void any warranty, stated or implied.

Any operation expressly prohibited in this manual, any adjustments or assembly procedures not recommended or authorized in this manual shall void the warranty.

Federal communications commission notice

This equipment has been tested and found to comply with the limits for a Class B digital device, pursuant to part 15 of the FCC Rules. These limits are designed to provide reasonable protection against harmful interference in a residential installation. This equipment generates, uses and can radiate radio frequency energy and, if not installed and used in accordance with the instructions, may cause harmful interference to radio communications. However, there is no guarantee that interference will not occur in a particular installation. If this equipment does cause harmful interference to radio or television reception, which can be determined by turning the equipment off and on, the user is encouraged to try to correct the interference by one or more of the following measures:

- Reorient or relocate the receiving antenna.
- Increase the separation between the equipment and the receiver.
- Connect the equipment into an outlet on a circuit different from that to which the receiver is connected.
- Consult the dealer or an experienced radio or television technician for help.

Declaration of conformity

Trade name : PHILIPS
Responsible party : Funai Corporation, Inc.
Model : 75PUL7552/F7, 65PUL7672/F7,
 65PUL7552/F7, 55PUL7672/F7,
 55PUL7552/F7, 50PUL7672/F7,
 50PUL7552/F7, 43PUL7672/F7,
 43PUL7652/F7
Address : 12489 Lakeland Road, Santa Fe
 Springs, CA 90670, USA*
Telephone number : 1 833 978 3323

* This is not the mailing address for Open Source Software or Customer service.

Modifications

This apparatus may generate or use radio frequency energy. Changes or modifications to this apparatus may cause harmful interference.

Any modifications to the apparatus must be approved by Funai Corporation.

The user could lose the authority to operate this apparatus if an unauthorized change or modification is made.

Cables

Connections to this device must be made with shielded cables with metallic RFI/EMI connector hoods to maintain compliance with FCC Rules and regulations.

Canadian notice

**CAN ICES-3 (B)/NMB-3 (B)
 Analog and digital television receiving apparatus, Canada
 BETS-7/NTMR-7.**

The following FCC/IC RSS applies to the wireless LAN adapter included in this product.

FCC caution: Any changes or modifications not expressly approved by the party responsible for compliance could void the user's authority to operate this equipment.

This transmitter must not be co-located or operated in conjunction with any other antenna or transmitter.

FCC/IC RF Exposure Compliance

This equipment complies with FCC/IC radiation exposure limits set forth for an uncontrolled environment and meets the FCC radio frequency (RF) Exposure Guidelines and RSS-102 of the IC radio frequency (RF) Exposure rules.

This equipment should be installed and operated keeping the radiator at least 20 cm or more away from your body.

This device complies with Part 15 of FCC Rules and Industry Canada licence-exempt RSS standard(s). Operation is subject to the following two conditions: (1) this device may not cause interference, and (2) this device must accept any interference, including interference that may cause undesired operation of this device.

5150-5250 MHz band is restricted to indoor operations only.

High-power radars are allocated as primary users (i.e. priority users) of the bands 5250-5350 MHz and 5650-5850 MHz and that these radars could cause interference and/or damage to LE-LAN devices.

Compliance with FCC requirement 15.407(c) and IC requirement RSS-210A9.4.4

Data transmission is always initiated by software, which is the passed down through the MAC, through the digital and analog baseband, and finally to the RF chip. Several special packets are initiated by the MAC. These are the only ways the digital baseband portion will turn on the RF transmitter, which it then turns off at the end of the packet. Therefore, the transmitter will be on only while one of the aforementioned packets is being transmitted. In other words, this device automatically discontinues transmission in case of either absence of information to transmit or operational failure.

Positioning the TV

- Large screen TVs are heavy. 2 people are required to carry and handle a large screen TV.
- Make sure to hold the upper and bottom frames of the unit firmly as illustrated.
- Install the unit in a horizontal and stable position.
- Do not install the unit in direct sunlight or in a place subject to dust or strong vibration.
- Depending on the environment, the temperature of this unit may increase slightly. This is not a malfunction.
- When installing this unit in a temperate environment, avoid a place with rapid temperature changes.
 - Operating temperature: 41 °F (5 °C) to 104 °F (40 °C)
- This unit should not be used in a tropical environment as it has not been evaluated under such conditions.
- No objects should be placed directly on or under this unit, especially lighted candles or other flaming objects.
- Depending on your external devices, noise or disturbance of the picture and/or sound may be generated if the unit is placed too close to them. In this case, please ensure enough space between the external devices and the unit.
- Do not insert the AC power cord into the power socket outlet before all the connections are made.
- Ensure that you always have easy access to the AC power cord and outlet to disconnect the TV from the AC outlet.
- Before you move the TV, disconnect attached cables to prevent damage to connectors, especially the TV tuner.
- Be sure to unplug the AC power plug from the AC outlet before moving or carrying the unit.
- When moving the TV and then setting it down, please be careful not to pinch the AC power cord under the unit.
- Do not place this unit in an area where it may be exposed to water, oil or grease such as: near a bathtub, basin, kitchen sink, washing tub, swimming pool, kitchen exhaust fan, etc., or in a damp basement.

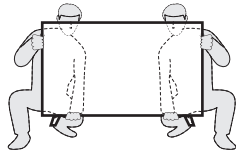

Do not place the unit on the furniture that is capable of being tilted by a child and an adult leaning, pulling, standing or climbing on it. A falling unit can cause serious injury or even death.

In order to avoid interruption of ventilation, this unit should not be placed in built-in equipment such as a book cabinet, rack, etc., and the vents of this unit should not be covered with anything such as a tablecloth, curtain, newspaper, etc. Make sure that there is enough ventilation space (4"/10 cm or more) around this unit.

Press **⏻ (POWER)** to turn the unit on and go into standby mode. To completely turn off the unit, you must unplug the AC power plug from the AC power outlet. Disconnect the AC power plug to shut the unit off when trouble is found or not in use. The AC plug shall remain readily available.

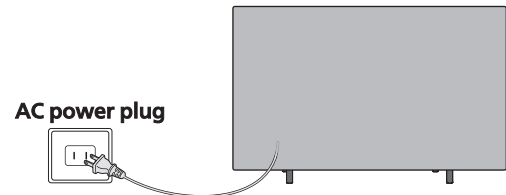

Never use a gas duster on this TV. The gas trapped inside of this unit may cause ignition and explosion.

Environmental care



The packaging of this product is intended to be recycled. Contact your local authorities for information about how to recycle the packaging.

For product recycling information, please visit - www.recycle.philips.com

End of life directives

Philips pays a lot of attention to produce environmental-friendly products in green focal areas. Your new TV contains materials which can be recycled and reused. At the end of its life, specialized companies can dismantle the discarded TV to concentrate the reusable materials and to minimize the amount of materials to be disposed of. Please ensure you dispose of your old TV according to local regulations.

⚠ Batteries usage

CAUTION : Danger of explosion if battery is incorrectly replaced. Replace only with the same or equivalent type.

WARNING: Batteries (battery pack or battery installed) should not be exposed to excessive heat such as sunshine, fire or the like.

- Do not mix old and new batteries.
- Do not mix alkaline, standard (carbon-zinc) or rechargeable (ni-cad, ni-mh, Li-ion, etc.) batteries.

Disposal of used batteries

The batteries included do not contain the heavy metals mercury and cadmium, however in certain localities, disposing batteries with household waste is not permitted. Please ensure you dispose of batteries according to local regulations.

Regulatory notices

WARNING: To prevent injury, this apparatus must be securely attached to the furniture/wall in accordance with the instructions. Tipping, shaking or rocking the unit may cause injury/death.

Stability Hazard

A television set may fall, causing serious personal injury or death.

Never place a television set in an unstable location. Many injuries, particularly to children, can be avoided by taking simple precautions such as:

- Always use cabinets, stands or mounting instruction recommended by the manufacturer of the television set.
- Always use only furniture that can safely support the television set.
- Always ensure the television set is not overhanging the edge of the supporting furniture.
- Always educate children about the dangers of climbing on furniture to reach the television set or its controls.
- Certainly wire the cords and cables connected to television set that cannot be routed, pulled and pinched.
- Not placing the television set on unstable place.
- Not placing the television set on tall furniture (for example, cupboards or bookcases) without anchoring both the furniture and the television set to a suitable support.
- Not placing the television set on cloth or other materials that may be located between the television set and supporting furniture.
- Not placing anything such as toys or controls that tempts children on a TV or furniture which a TV is placed.

If the existing television set is going to be retained and relocated, the same considerations as above should be applied.

Preparing to move/ship the unit

Please pack the unit properly by following the diagram on the carton.

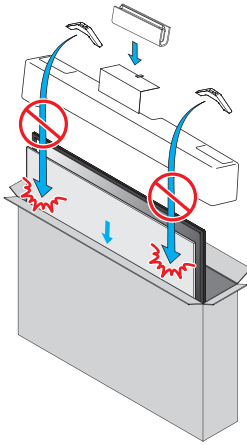

CAUTION: Please save the front cardboard* to use when moving or shipping the TV.

CAUTION: To avoid damage to the screen, do not pack the stand on the same side as the TV screen, refer to the illustration above.

* Cardboard is included in select models only.

Copyright

All other registered and unregistered trademarks are the property of their respective owners.



The terms HDMI and HDMI High-Definition Multimedia Interface, and the HDMI Logo are trademarks or registered trademarks of HDMI Licensing Administrator, Inc. in the United States and other countries.



Manufactured under license from Dolby Laboratories. Dolby, Dolby Audio, and the double-D symbol are trademarks of Dolby Laboratories Licensing Corporations.



The Bluetooth® word mark and logos are registered trademarks owned by Bluetooth SIG, Inc. and any use of such marks by Funai Electric Co., Ltd. is under license. Other trademarks and trade names are those of their respective owners.

Google, Google Play, Android, YouTube, and related marks and logos are trademarks of Google LLC.

Use of key features of this TV requires consent to Google Terms of Service and Privacy Policy.

This device complies with part 15 of the FCC Rules. Operation is subject to the following two conditions: (1) This device may not cause harmful interference, and (2) this device must accept any interference received, including interference that may cause undesired operation.

Features and specifications are subject to change without notice.

Network services, content, and the operating systems and software of this Product may be subject to individual terms and conditions and changed, interrupted or discontinued at any time and may require fees, registration and credit card information.

The American Academy of Pediatrics discourages television viewing for children younger than two years of age.

Some features may require an always-on broadband internet connection, firmware update and/or a minimum bandwidth. Internet services vary by location.

2 Getting started

What's included

Quick start guide



Safety instruction / Limited warranty



Caution sheet



TV base and screws *

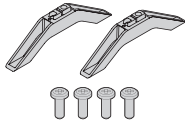

Remote and Batteries (AAA, 1.5 V x 2)

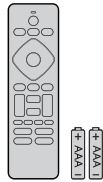

* Screws packed with this unit.

Model	Quantity	Size
75PUL7552/F7	4	M5 x 0.945" (24 mm)
65PUL7672/F7		M4 x 0.709" (18 mm)
55PUL7672/F7		
55PUL7552/F7		
50PUL7672/F7		
50PUL7552/F7		
65PUL7552/F7		M4 x 0.630" (16 mm)
43PUL7672/F7	ST4 x 0.984" (25 mm)	
43PUL7652/F7		

Note(s)

- If you lose the screws, please purchase the above-mentioned phillips head screws at your local store.
- If you need to replace these accessories, please refer to the part name or No. with the illustrations and call our toll free customer support line found on the cover of this user manual.

When using a universal remote to operate this unit.

- Make sure the component code on your universal remote is set to our brand. Refer to the instruction book accompanying your remote for more details.
- We do not guarantee 100% interoperability with all universal remote.

Installing TV

Unpacking and Installing the stands

<75" - 65">

1

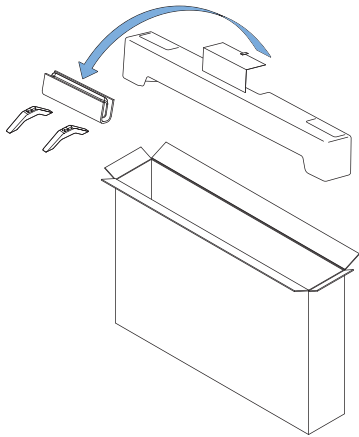

2

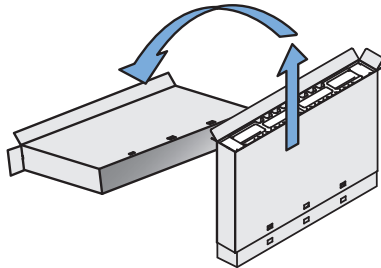

3

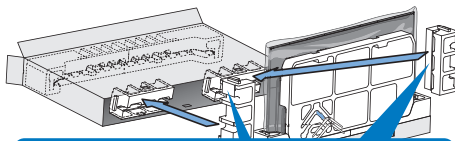

Move to the front of the slipbox.

4

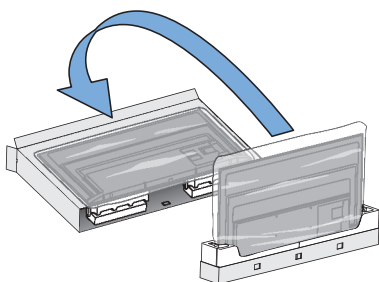

Note(s)

Carefully lay the TV set, with the screen side down, on the outer slipbox so as not to deform or damage chin at the bottom of the unit.

5

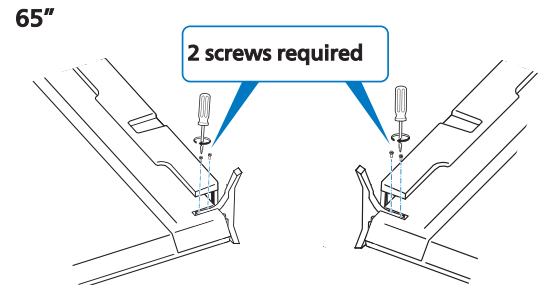
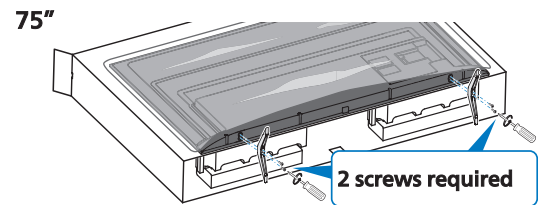

Note(s)

Prior to attaching each stand, make sure to peel off the protective film where each stand goes in so it will not get stuck between the unit and the stand. Fasten the stand to the unit with 2 screws each (included).

6 Both stands should now be securely fastened.

7 Carefully lift the TV set as shown in the illustration and place it onto a stable, level surface.

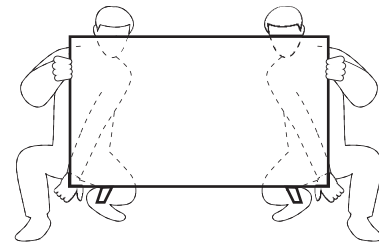

<43" – 55">

1

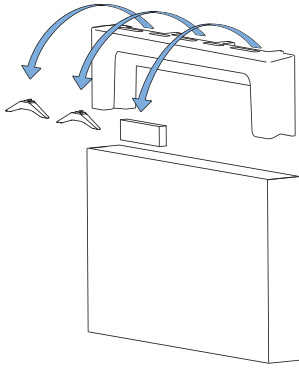

2

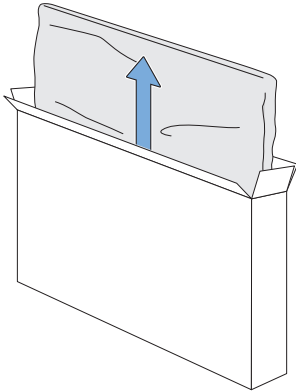

3 Cover a table top with a cloth or blanket to avoid damage to the TV screen. Hold both sides of the TV set to place on the table.

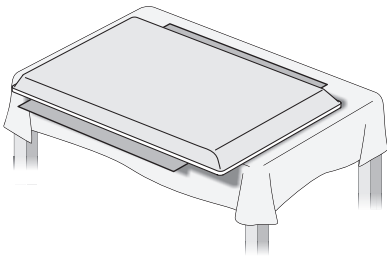

Note(s)

- Carefully lay the TV set, with the screen side down, on the front cardboard as shown in the figure.

4 Fasten the stands to the TV with 4 screws (included).

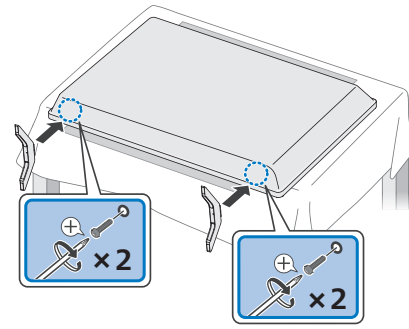

Note(s)

While fastening the screws, hold the stand to prevent it from falling.

5 Both stands now be securely fastened.

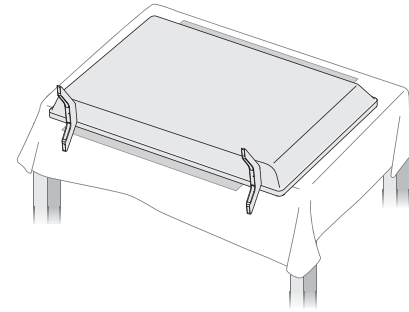

Note(s)

- A wide open space is recommended for assembly.
- A Phillips-head screwdriver is required to fasten the stands to the TV set.
- When attaching the stand, ensure that all screws are tightly fastened. If the stand is not properly attached, it could cause the unit to fall, resulting in injuries as well as damage to the unit.
- To remove the stand from this unit, unscrew the phillips-head screws by reversing the procedure. Be careful not to drop the stand when you remove it.

6 Carefully lift the TV set as shown in the illustration and place it onto a stable, level surface.

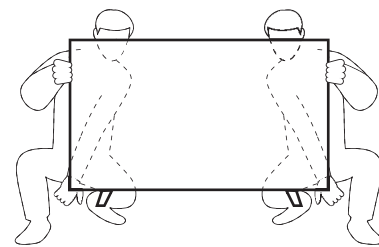

Wall mount

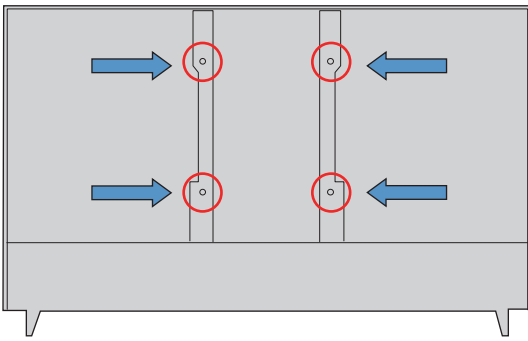

	Brand	Model #	Screw dimension	VESA size
75PUL7552/F7	SANUS	F80b	M8 x 0.787" (20 mm)	15.74" x 7.87" (400 x 200 mm)
65PUL7672/F7, 65PUL7552/F7		VLT6-B1	M6 x 1.378" (35 mm)	15.74" x 11.81" (400 x 300 mm)
55PUL7672/F7, 55PUL7552/F7, 50PUL7672/F7, 50PUL7552/F7				11.81" x 11.81" (300 x 300 mm)
43PUL7672/F7, 43PUL7652/F7		25BB	M6 x 0.472" (12 mm)	7.87" x 7.87" (200 x 200 mm)

Your TV meets the VESA standard for wall mounting. Consult with your local dealer for a wall mount bracket which is compatible with your TV model.

- The recommended wall mount bracket kit (sold separately) allows the mounting of the TV on the wall.
- For detailed information on installing the wall mount, refer to the wall mount Instruction book.
- Funai Corporation is not responsible for any damage to the product or injury to yourself or others if you elect to install the TV wall mount bracket or mount the TV onto the bracket.
- The wall mount bracket must be installed by experts.

Funai Corporation is not liable for these types of accidents or injuries noted below.

- If installed onto a ceiling or slanted wall, the TV and wall mount bracket may fall which could result in a severe injury.
- Do not use screws that are longer or shorter than their specified length. If screws too long are used this may cause mechanical or electrical damage inside the TV set. If screws too short are used this may cause the TV set to fall.
- Do not fasten the screws by excessive force. This may damage the product or cause the product to fall, leading to an injury.
- For safety reasons use 2 people to mount the TV onto a wall mounting bracket.
- Do not mount the TV onto the wall mounting bracket while your TV is plugged in or turned on. It may result in an electrical shock injury.

When installing the unit on the wall, allow this much space.

Top	: 11.8" (30 cm)
Left and right side	: 5.9" (15 cm)
Bottom	: 3.9" (10 cm)

Control Panel & Terminal

Control panel

<75 series>

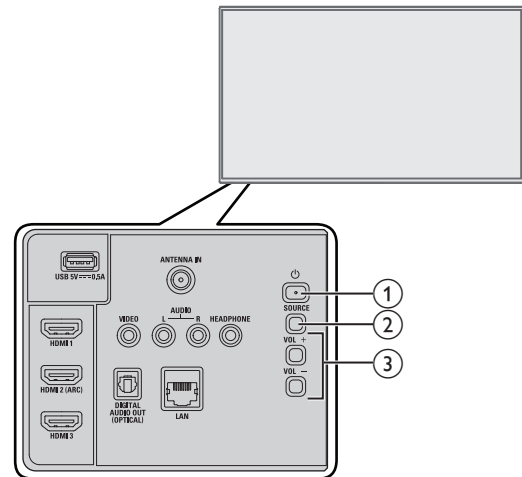

<76 series>

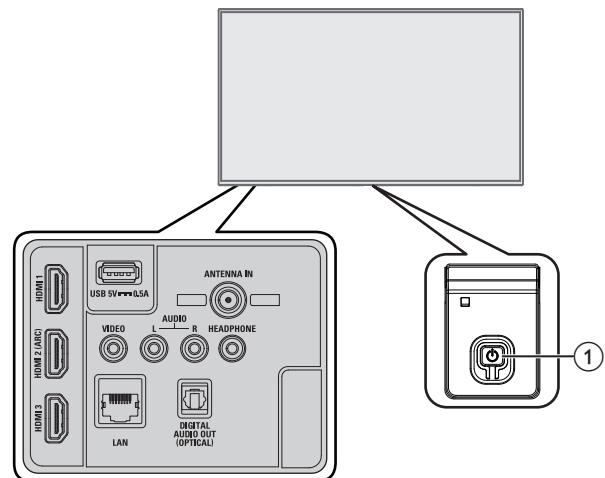

- ① **⏻ (POWER)**
Turns the TV on or switches the TV into standby mode.
- ② **SOURCE**
Selects connected devices.
- ③ **VOL +/-**
Adjusts the volume.

Terminals

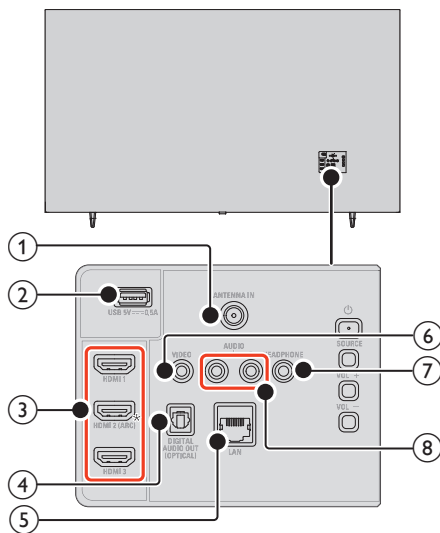

- ① **75 ohm Cable/Antenna connection**
Signal input from an antenna or Cable/Satellite set-top boxes.
- ② **USB terminal**
Data input from USB memory stick only.
- ③ **HDMI input jack(s)**
Digital audio and video input from high definition digital devices such as DVD/Blu-ray Disc™ players, Soundbar/cable/satellite set-top boxes, PC's, etc.
 - HDMI-DVI/Analog audio (L/R) jacks signal
 - Composite video/Analog audio (L/R) jacks signal
 - PC connection/Analog audio (L/R) jacks signal with stereo mini 3.5 mm plug audio cable on PC
 * For HDMI 2 only: In addition to normal HDMI functionality, it outputs TV audio to an HDMI-ARC compliant device, such as a soundbar and home theater system.
- ④ **Digital audio output (Optical) jack**
Digital audio (SPDIF) output to home theaters and other digital audio systems.
- ⑤ **Ethernet port**
For internet connection using an Ethernet cable with an RJ-45 connector.
- ⑥ **Composite video (VIDEO) input jack**
Connect composite analog video signal.
- ⑦ **Headphone audio output jack**
Headphone 3.5 mm stereo jack for personal listening.
- ⑧ **Analog audio (L/R) input jacks**
Connect analog audio signals from;
 - HDMI-DVI/Analog audio (L/R) jacks signal
 - Composite video/Analog audio (L/R) jacks signal
 - PC connection/Analog audio (L/R) jacks signal with stereo mini 3.5 mm plug audio cable on PC

Note(s)

- This TV has a USB port which is designed for connecting peripheral devices, such as a keyboard or mouse. While you may find that a particular keyboard or mouse works to some extent, we cannot guarantee full functionality. You will not damage the TV in any way by trying various keyboards or mice, but the performance of that device may be limited.

Connect devices

Watch TV

Please choose your type.

Be sure your antenna or another device is connected properly before plugging in the AC power cord.

A. Directly TV to Antenna through RF cable

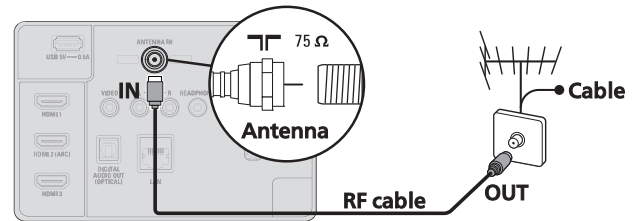

B. Satellite set-top box through RF cable

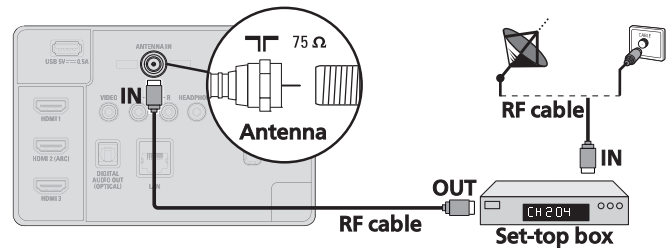

C. Satellite set-top box through RF & HDMI

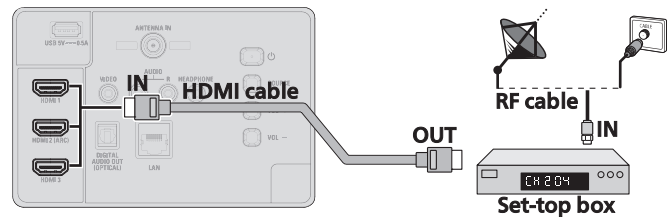

* You must use UltraHD 4K HDMI cable for 4K video.

Note(s)

- If you have any question about the DTV's antenna, visit www.antennaweb.org for further information.
- Depending on your antenna system, you may need different types of combiners (mixers) or separators (splitters) for HDTV signal. The minimum RF bandpass on these devices is 2,000 MHz or 2 GHz.
- For your safety and to avoid damage to this unit, please unplug the RF coaxial cable from the antenna input jack before moving the unit.
- If you did use an antenna to receive analog TV, it should also work for DTV reception. Outdoor or attic antennas will be more effective than a set-top box or inside antenna.
- To turn on your reception source easily between antenna and cable, install an antenna selector.
- If you are not receiving a signal from your cable service, contact the cable provider.

Game console/BD/DVD player

Please choose your type.

Below cables are not included with TV. need to purchase separately:

- Please purchase the necessary cables at your local store.

Before you connect the AC power cord:

Be sure other devices are connected properly before plugging in the AC power cord.

HDMI - Highest quality

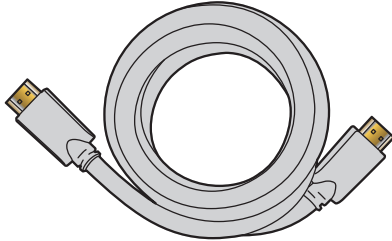

Supports high-definition digital signals and gives highest picture and sound quality. Video and audio signals are combined in one cable. You must use HDMI for full high-definition video and to enable HDMI control (HDMI CEC).

Note(s)

- Philips HDMI supports HDCP (High-bandwidth Digital Contents Protection). HDCP is a form of digital rights management that protects high-definition content in Blu-ray Disc™ or DVDs.
- The HDMI-ARC connector on the TV features HDMI-ARC functionality. This allows output of TV audio to an HDMI-ARC-compliant device.

Composite - Basic quality

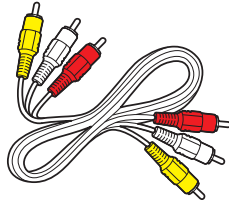

For analog connections. Composite video/Audio analog cable usually combine a yellow video cable with red/white audio (L/R) cables.

A. HDMI — HDMI (High quality)

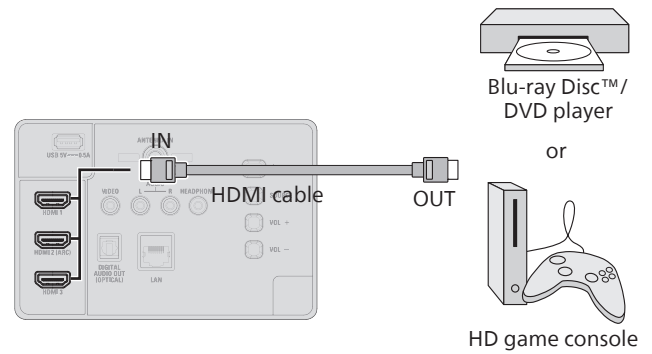

* You must use UltraHD 4K HDMI cable for 4K video.

B. AV cable (standard quality)

Composite analog video connection

Composite analog video connection offers standard picture quality for video devices connected to the unit.

If you connect to the unit's composite video (VIDEO) input jack, connect audio cables to the audio (L/R) input jacks. When the audio is monaural, then only connect to the audio L input jack.

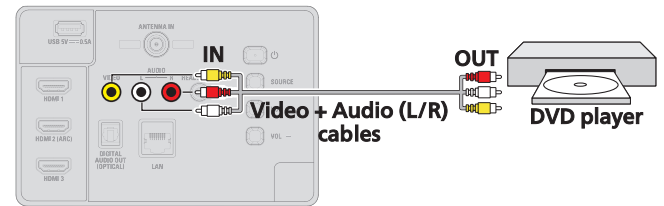

Home theater speaker

Please choose your type.

A. Digital audio output cable

You can enjoy multi-channel audio like 5.1ch digital broadcasting sound.

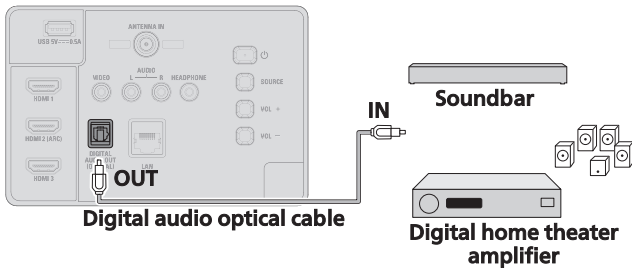

B. HDMI-ARC cable (Audio Return to Channel)

HDMI-ARC allows you to use HDMI control to output TV audio directly to a connected audio device, without the need for an additional digital audio cable.

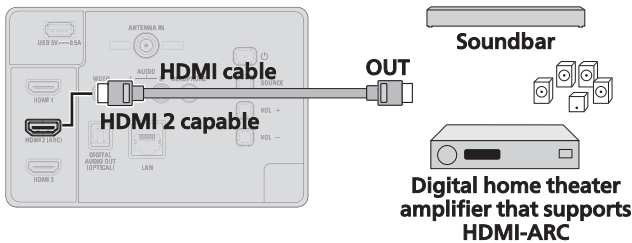

Note(s)

- The HDMI 2 connector is HDMI Audio Return Channel (ARC) compliant. Use it to output digital audio to an HDMI home theater system.
- Be sure that the device is HDMI CEC and ARC compliant and that the TV is connected to the device using an HDMI cable attached to HDMI-ARC connectors.
- The HDMI-ARC connector on the TV features HDMI-ARC functionality. This allows output of TV audio to an HDMI-ARC-compliant device.

PC screen

Please choose your type.

A. HDMI cable

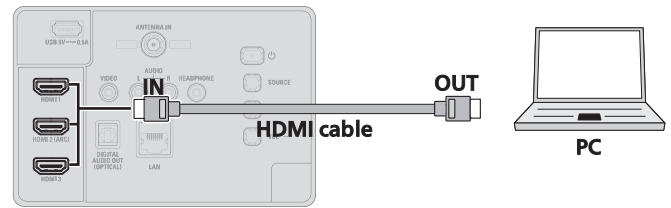

Format	Resolution	Refresh rate
VGA	640 x 480	60 Hz
SVGA	800 x 600	
XGA	1,024 x 768	
WXGA	1,280 x 768	24/30/60 Hz
	1,360 x 768	
FHD	1,920 x 1,080	
UHD	3,840 x 2,160	
	4,096 x 2,160	

Other formats or non-standard signals will not be displayed correctly.

* When connecting with HDMI-DVI, the operation is maximum 2160p@30 Hz.

Note(s)

- Please purchase a HDMI-DVI conversion cable that has a ferrite core.
- The following operations may reduce noise.
 - Attach a ferrite core to the AC power cord of your PC.
 - Unplug the AC power cord and use the built-in battery of your portable/laptop PC.
- Some HDMI cables and devices may not be compatible with the TV due to different HDMI specifications.
- Use an HDMI cable with the HDMI logo (a certified HDMI cable). High speed HDMI cable is recommended for the better compatibility.
- The unit accepts 480p, 720p, 1080p and 2160p video signals only when using the HDMI connection and HDMI-DVI connection. When connecting with HDMI-DVI, the operation is maximum 2160p@30 Hz.
- HDMI-DVI connection requires separate audio connections as well and the audio signals are output as analog (L/R) audio.
- DVI does not display 480i image which is not in compliance with CTA-861-G.
- Overscaling, also referred to as overscanning, is when a computer's display renders outside of the viewable area of a monitor or TV screen. It's like having the outer edges of a photo partially covered by a picture frame due to the picture being too large.

B. HDMI-DVI cable

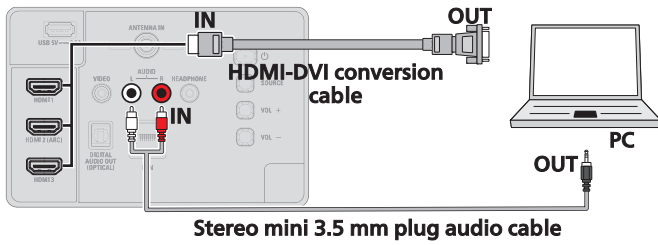

C. Cast to Google TV (Wireless)

Cast to Google TV

You can cast content from phones, tablets, or laptops to your Google TV.

Please go to [Cast to Google TV](#) ➔ p. 43 for more details.

Connect devices - Internet router

A. Connecting the TV to the internet using an Ethernet cable

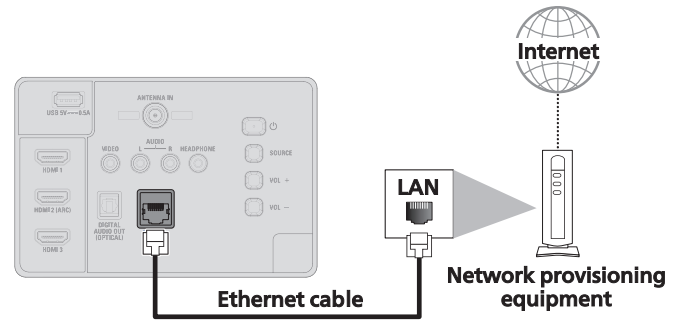

Note(s)

- Please purchase shielded Ethernet cables at your local store and use them when you connect to network equipment.
- After connecting an Ethernet cable, set up necessary network settings. [Network & Internet](#) ➔ p. 25
- Do not insert any cable other than an Ethernet cable to the Ethernet port to avoid damaging the unit.
- If your telecommunications equipment (modem, etc.) does not have broadband router functions, connect a broadband router.
- If your telecommunications equipment (modem, etc.) has broadband router functions but there is no vacant port, then add a hub.
- For a broadband router, use a router which supports 10BASE-T/100BASE-TX.
- Do not connect your PC directly to the Ethernet port of this unit.

3 Completing the first time setup

Remote

Installing the Batteries

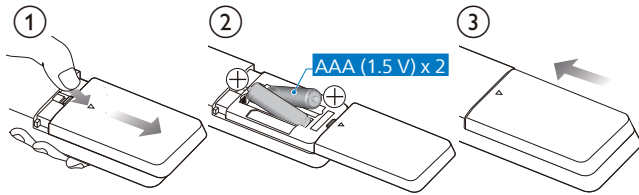

- 1 Open the battery cover by sliding down.
- 2 Insert 2 AAA (1.5 V) batteries matching the polarity indicated inside battery compartment of the remote.
- 3 Slide the cover back into position.

Note(s)

- Remove the batteries if not using the remote for an extended period of time.

Buttons

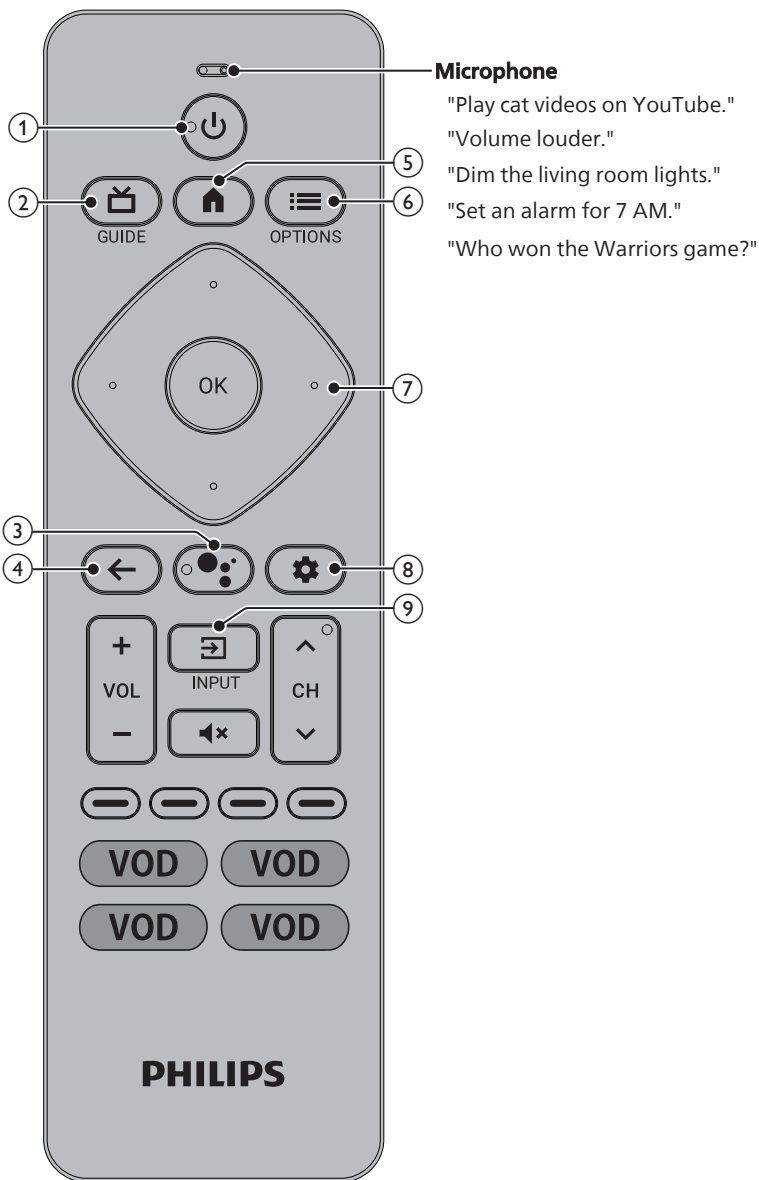

- ① **⏻ (POWER)**
Turn TV on or off. Press for less than 1 second to go into Quick Start Standby. Hold for 1 second or more to go into Low Power Standby.
- ② **📺 (GUIDE)**
See what's live on TV across different service providers in one menu. (Only available in U.S.)
- ③ **Google Assistant**
Press and hold the Google Assistant button on your remote to talk to Google.
- ④ **⬅️ (BACK)**
Returns to the previous screen.
- ⑤ **🏠 (HOME)**
Access to your apps, Live TV, input devices, settings, and the Google Play Store.
- ⑥ **☰ (OPTIONS)**
Quick access to Settings (Settings varies depending on active screen).
- ⑦ **⬆️ (CURSOR as ▲▼◀▶) and OK**
Moves to select an item and to determine on the various menu.
- ⑧ **⚙️ (DASHBOARD)**
The Google TV dashboard provides a single location for users to access settings, notifications, kids mode and more.
- ⑨ **📺 (INPUT)**
Select input source for connected devices.

Talk to Google Assistant

On your Google TV remote, press and hold the Google Assistant button  and ask a question or say a command. To help Google Assistant understand your request, speak into the microphone on your remote.

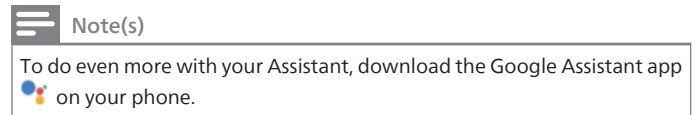

Privacy protection built-in

The Google Assistant is designed with your privacy in mind. You can delete any voice-command history by pressing Google Assistant button and simply saying "Delete what I just said".

For more details on privacy, please visit: <https://safety.google/intl/en-US>

Initial set-up

Plug in and turn on TV

Connect the AC power cord to the AC outlet. Press the **⏻ (POWER)** on your remote.

Make sure that AC power cord must be plugged to AC outlet after all the necessary connections are made.

Follow the on-screen instructions

After you get your Google TV device, you'll need to set it up.

What you need

- The Google Home app on your phone (recommended)
 - A Wi-Fi internet connection (needed to connect your TV to the Internet)
 - A Google Account (needed to access entertainment across thousands of streaming channels)
- * To turn on TalkBack during setup, on your remote, press and hold the Back and Down buttons at the same time for 3 seconds.

Get started with setup

Follow this step by step process to help you complete your Google TV.

Note(s)

If you choose Set up basic TV, refer next page.

- 1 Select your language and region or country.

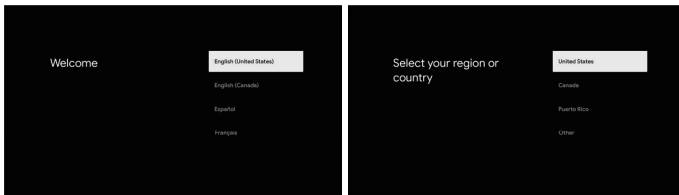

- 2 Choose Set up Google TV.

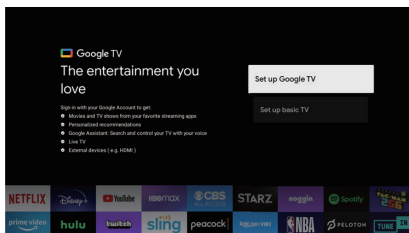

Finish setup with the Home app

- ① On your phone, open Google Home .
- ② At the top left, tap Add + > Set up device > Set up new devices in your home.
- ③ Choose or add a home.
- ④ Tap Scan code and allow the app to use your phone's camera.
- ⑤ Scan the QR code on your TV screen.

Note(s)

It may take a few minutes for your phone and TV to connect.

- ⑥ Follow the instructions in the Home app and on your TV screen.

Fix problems with set up

You might need to set up your Google TV with your remote if:

- ① You get stuck when you set up with the Home app
- ② You can't update the Home app
- ③ Your device doesn't appear in the Home app

Finish setup with your remote

- ① On your remote, hold the Back button.
- ② When "Having trouble?" appears on your TV screen, choose Set up with remote.
- ③ Choose a Wi-Fi network and enter the password.
- ④ Sign in to your Google Account.
- ⑤ Follow the on-screen instructions.

- 3 Select **Home**. Retail is only for use in store.

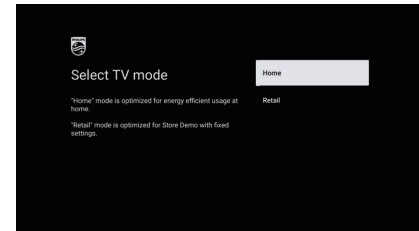

- 4 Setting up the time zone.

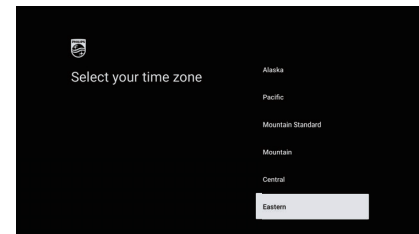

In Full mode:

The time zone setup screen will not appear as the time zone is automatically set up.

In Basic mode:

When **USA**, **Canada**, or **Other** is selected under **Country**, the time zone setup screen will appear.
When **Puerto Rico** is selected under **Country**, the time zone setup screen will not appear as only AST is available.

- 5 Chromecast built-in is a technology that lets you stream your favorite entertainment and apps from your phone, tablet or laptop right to your TV.

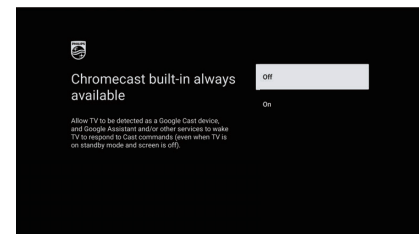

6 Scan the channels.

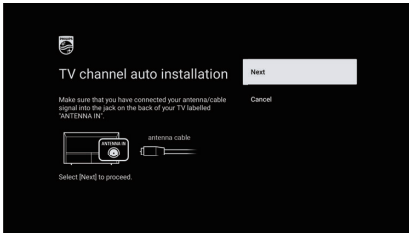

7 Pair your remote control with TV.

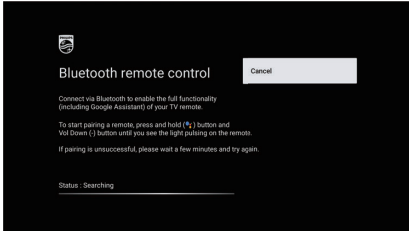

Note(s)

This screen will appear only when a pairing between the remote and the TV has not been completed. A pairing process is basically done automatically in the background.

8 Register your television.

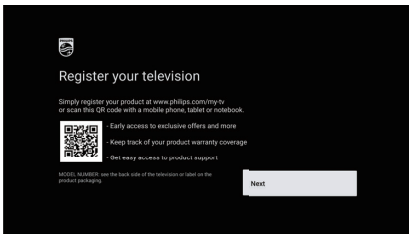

9 Installing your apps. Depending on the number of apps selected, this may take some time.

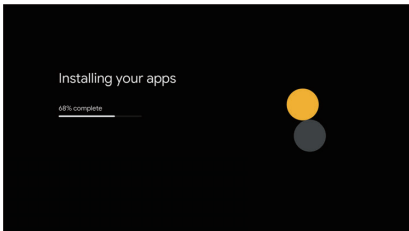

10 Setup Complete. you are ready to go.

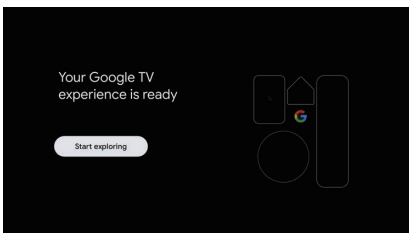

Basic TV mode

Use basic TV on a Google TV device

Important: You can only use basic TV on TVs that come with Google TV built in.

If you choose basic TV when you set up your Google TV device, you can:

- Finish setup faster
- Use your device without a Google Account
- Use your device without an internet connection
 - Without an internet connection, your device won't get important security updates.

* Some features aren't available in basic TV.

Switch from basic TV to Google TV

- ① From the home screen, scroll to the Google TV banner.
- ② Select Set up Google TV.
- ③ Follow the on-screen instructions to set up with the Home app or your remote.

Note(s)

If you already set up Google TV, you can't switch to basic TV. To start setup again, you can factory reset your device. Refer to **Restart** → p. 32.

What you CAN do in basic TV	What you CAN'T do in basic TV
<ul style="list-style-type: none"> • Watch TV through your cable service, satellite, TV tuner, or antenna with the TV app 	<ul style="list-style-type: none"> • Use services and features that require you to sign in to your Google Account
<ul style="list-style-type: none"> • Play media from other inputs plugged into the TV 	<ul style="list-style-type: none"> • Access your Play Library
<ul style="list-style-type: none"> • Use a limited set of apps that come pre-installed on your device 	<ul style="list-style-type: none"> • Install apps
	<ul style="list-style-type: none"> • Use the Assistant to search for content
	<ul style="list-style-type: none"> • Cast content from another device

Basic TV - Home screen

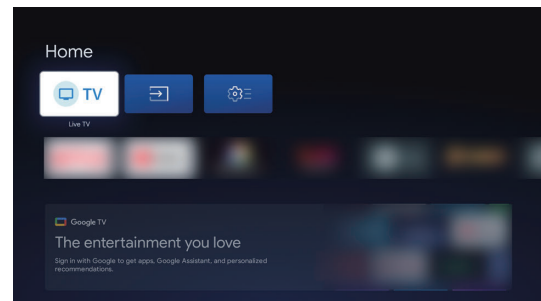

4 Using the On-Screen Menu

Home menu

Google TV is TV personalized for you. Easily browse content from across your favorite apps and services, with specially curated recommendations based on your interests.

What you find on the Google TV home screen depends on where you live and the language you choose for your device.

- If you use a Google TV device in a country other than the one where you purchased it, your experience may vary.
- In some regions or territories, your experience may vary.

If you choose English, French, or Spanish as your language, you'll find these tabs:

- 1 Search**
Search movies, shows, apps and more.
- 2 For you**
Google TV home screen aggregates the best content from user's services.
- 3 Live tab**
See what's live on TV across different service providers in one menu. To watch live TV, download an app from your TV service provider (if available). This service is available only in the U.S.
- 4 Movies and Shows tab**
Discover new movies and shows with suggestions based on what you've watched and what interests you.
- 5 Apps tab**
Access your installed apps library or find new ones based on what you use or download.
- 6 Library tab**
Find movies and TV shows you've added in your Watchlist or rented through the Google TV store or YouTube.
- 7 Dashboard**
Google TV dashboard provides a single location for users to access settings, notifications, and kids mode.

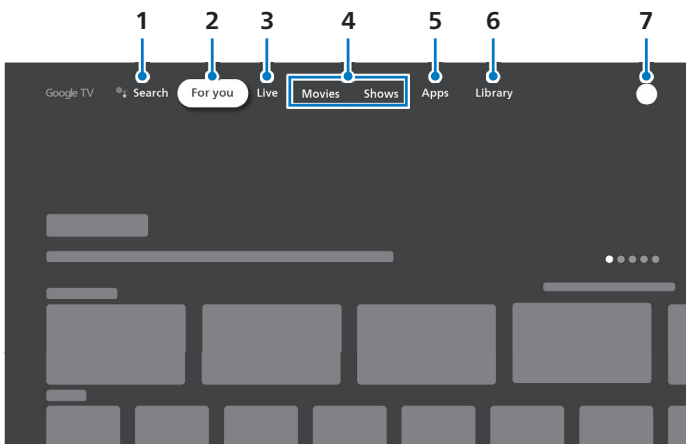

If you choose a different language or other countries, you'll find these tabs:

- Home
- Apps
- Library

Dashboard

The Google TV dashboard provides a single location for users to access, settings, notifications, picture settings and more.

To open the panel, please press **DASHBOARD** on your remote from the Google TV home screen.

- 1 Press **HOME** to display the Home menu.



- 2 From the Google TV home screen, in the top right, go to the profile icon.

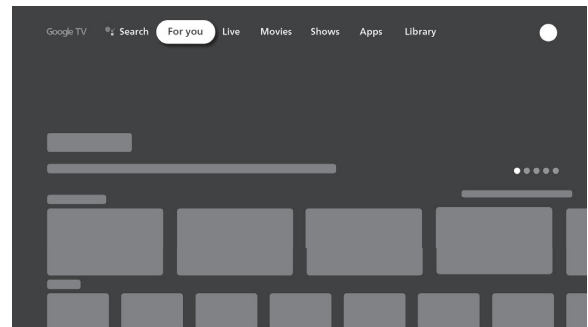

- 3 Use **▲▼◀▶** to select the desired menu and an item, then press **OK**.

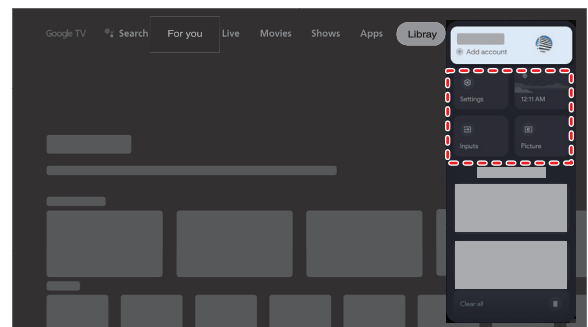

- **Settings**
- **Inputs**
-> Select and change access to the attached devices such as Blu-ray player, gaming consoles, or cable box.
- **Time & screen -> Ambient mode**
-> screen saver. For more detail, refer to **Ambient mode (Digital Photo Frame)** ➔ p. 42.
- **Picture**
-> Picture settings
- **Notification**
-> Message regarding important device updates

Channels & Inputs

To set Channels and Inputs,

- 1 From the Google TV home screen, in the top right, go to the profile icon and select **Settings**.
- 2 Go to **Channels & Inputs**

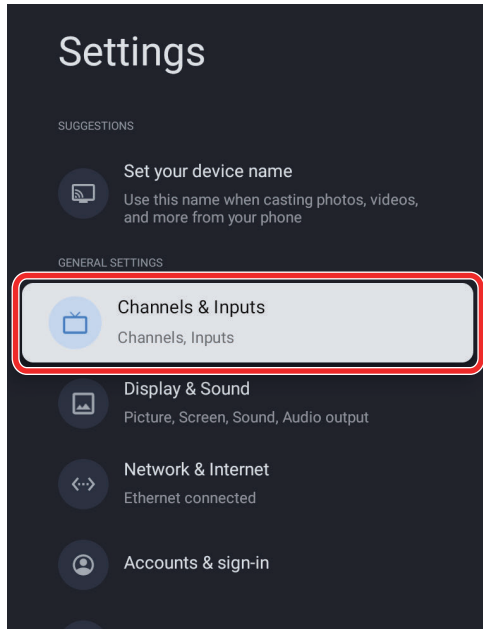

Add channels

To add for the first time or additional channels, please follow the steps below:

- 1 Go to **Settings > Channels & Inputs > Channels**
- 2 Select your signal type **Antenna/Cable** in Channel Installation mode.
- 3 Select **Channel Scan** to start channel installation.

Inputs

Show or Hide your TV Inputs

- Select your Input > Untick **Show this input** to hide

Rename your TV Inputs

Consumer Electronic Control (CEC) - This allows you to operate the linked functions between our brand devices with CEC feature and this unit. We do not guarantee 100% interoperability with other brands of CEC compliant devices.

- HDMI control
- Device auto power off
- TV auto power on

HDMI EDID Version - If there are issues with picture/color and/or sound when connecting an external device using the HDMI port, please try switching the HDMI mode.

Note(s)

- EDID 1.4 is used for legacy devices that can output in 2K or 4K @30 Hz.
- EDID 2.0 is used for modern devices that can output 4K @ 60 Hz and 4K with HDR 10.
- EDID 2.1 is used for modern devices that can output 4K @ 60 Hz, 4K and ALLM with HDR 10.

Display & Sound

To set Picture and Sound,

- 1 From the Google TV home screen, in the top right, go to the profile icon and select **Settings**.
- 2 Go to **Display & Sound**

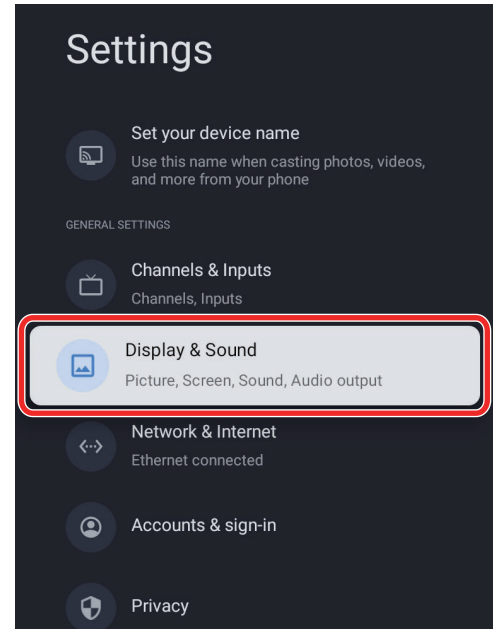

Picture

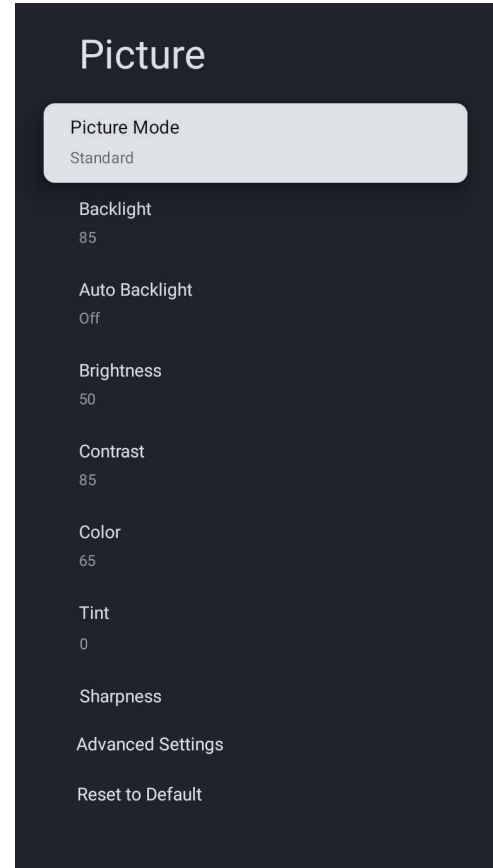

Picture Mode

User	The customized settings you preferred.
Standard	For normal TV viewing.
Vivid	Enhanced picture contrast and sharpness for viewing in a well-lit room.
Sports	Brilliant picture settings for high action.
Movie	Deep picture settings for a cinematic experience.
Game	Optimized for PCs and game consoles.
Energy Saving	Eco TV settings for low power consumption.

Backlight

Adjusts the LED brightness to affect the overall brilliant color.

Auto Backlight

Automatically adjusting the luminance level of each frame.

Brightness

Adjusts the black level of the picture.

Contrast

Adjusts the white level of the picture. If the setting is too high or too low, detail may be difficult to distinguish in dark or bright areas of the picture.

Color

Adjusts the intensity of the picture colors.

Tint

Adjusts the hue of the picture. This setting is useful in adjusting the flesh tones in the picture.

Sharpness

Adjusts the edge sharpness of picture elements. It can be used to sharpen non-HD (high definition) content; however, it will not produce detail that does not otherwise exist.

Advanced Settings

For more detailed picture settings, go to **Advanced Settings**, where you find settings for Color Temperature, Noise Reduction and etc.

Reset to Default

Reset the picture mode settings to factory default values.

Sound

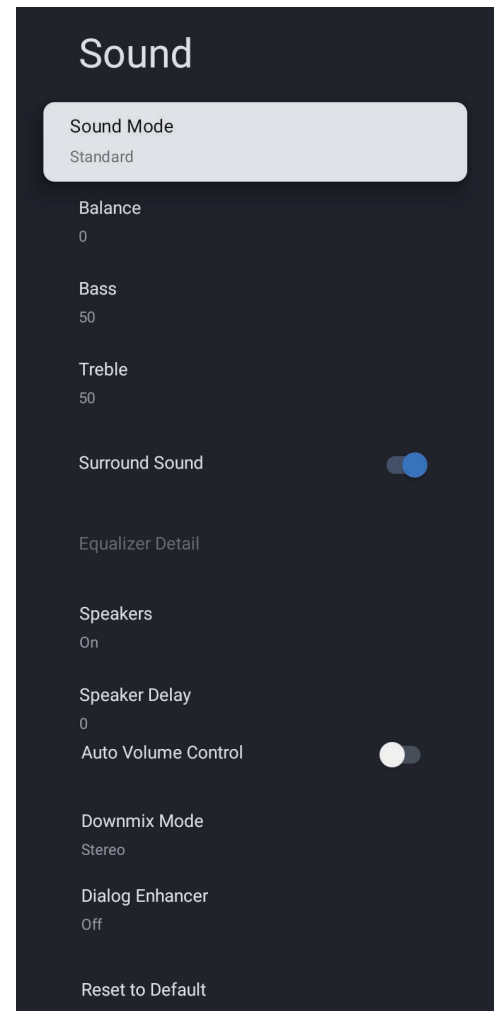

Sound Mode

The following sound settings can be configured. Depending on the format of the broadcasting, some sound settings are not available.

User	The customized settings you preferred.
Standard	For normal TV viewing.
Vivid	Enhanced sound.
Sports	Clear sound for high action.
Movie	Powerful sound settings for a cinematic experience.
Music	Optimized for music playback.
News	Set the anchor's voice at a comfortable volume.

Balance

Adjust the speakers to suit your listening preference.

Cursor ◀	Cursor ▶
To adjust the balance of the right and left speakers	

Bass

Cursor ◀	Cursor ▶
To adjust the Bass of the right and left speakers.	

Treble

Cursor ◀	Cursor ▶
To adjust the Treble of the right and left speakers.	

Surround Sound

This selects sound modes for more spatial or surround sound reproduction.

Off	To set Surround Sound to off
On	To set Surround Sound to on

Adjust the tonal quality for each frequency.

Equalizer Detail	<input type="radio"/> 120 Hz	This feature is turned off by default and can only be used if the sound mode is adjusted to User.
	<input type="radio"/> 500 Hz	
	<input type="radio"/> 1500 Hz	
	<input type="radio"/> 5000 Hz	
	<input type="radio"/> 10000 Hz	

Speakers

You can select the audio output from the unit's speakers or not. If your amplifier is HDMI link function compatible and connected by an HDMI cable to this unit, some sound operations such as volume up can be changed by using this unit's remote. Make sure **HDMI control** is set to **On**. ➔ p. 22

Off	To remove the Speakers.
On	Output from the external audio system when an external device is connected. Output from TV speakers when an external device is not connected.

Speaker Delay

Adjust speaker output timing in the case video and sound on the TV speakers are not synchronized. For example, lip movements seem to have wrong timing.

Auto Volume Control

This function keeps a constant Loudness differential between the TV commercials and the programs.

Off	To remove the Auto Volume Control
On	To reduce volume differences between the TV commercials and the programs

Downmix Mode

- Stereo
- Surround

Dialog Enhancer

- Off
- Minimum
- Medium
- Maximum

Reset to Default

Reset the sound settings.

Audio output

Digital Output

- Auto
- Bypass
- PCM
- Dolby Digital Plus
- Dolby Digital

Digital Output Delay

The on-screen picture and the sound from an amplifier via the digital audio (SPDIF) output jack are synchronized by delaying the output from the connection.

Cursor ◀	Cursor ▶
The higher values will increase the digital audio (SPDIF) output delay.	

Network & Internet

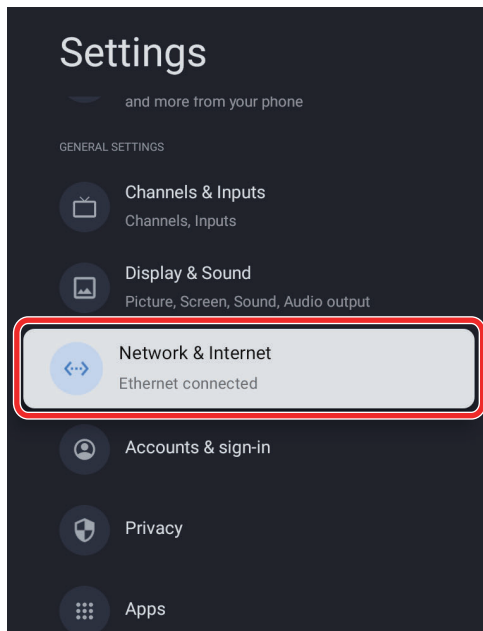

Setup network connection settings in order to use apps or network upgrade functions.

To set Network & Internet,

- 1 From the Google TV home screen, in the top right, go to the profile icon and select **Settings**.
- 2 Go to **Network & Internet**

Wi-Fi setting

- 1 Confirm that Wi-Fi is turned on and you're connected to the correct network.
- 2 If not, locate the network you'd like to connect to and select it to connect. Enter the password if required.
- 3 Open one of your apps.
- 4 Play your video, music, or game again.

Note(s)

If you still have issues, turn the Wi-Fi option off and on again.

Use your Mobile/Tablet hotspot

Automatically adjusts video quality to use less mobile data.

- **Data Saver** reduces your data usage on mobile connections, increasing watch time by up to 3x.
- **Data usage and alerts** help you monitor your data usage while watching TV.
- **Cast** in Files lets you view downloaded media from your phone on your TV without using data. Detail page → p. 43.

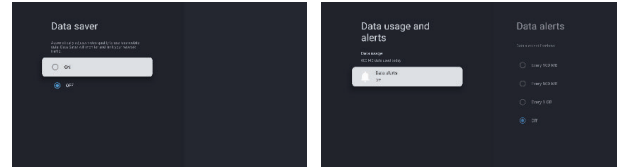

Scanning always available

Let Google's location service and other apps scan for networks, even when Wi-Fi is off.

Ethernet

Proxy settings: Set Proxy manually.

IP settings: Configure the IP setting for your network connection.

Wake configs

WoW: Wake on Wireless network

WoL: Wake on LAN

WoC: Wake on Chromecast

Accounts & sign-in

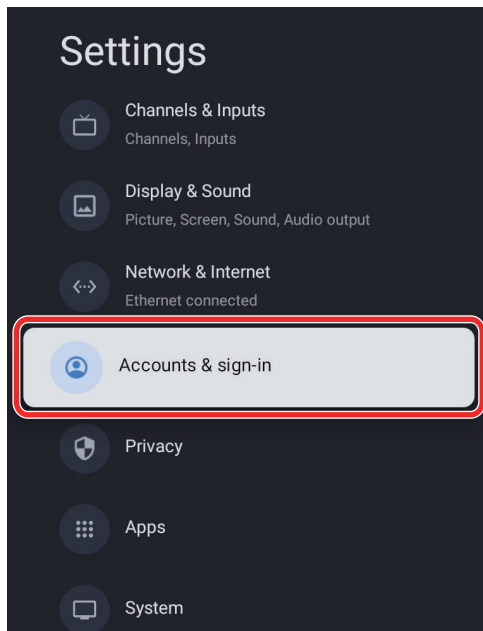

- 1 From the Google TV home screen, in the top right, go to the profile icon and select **Settings**.
- 2 Go to **Accounts & sign-in**
You can manage to add or remove your Google account and kids profile account.

Google Account

Google TV profiles let everyone in your home enjoy their own personalized space with their Google Account. With a personalized profile, you'll get TV show and movie recommendations just for you, easy access to your personal watchlist and help from your Google Assistant.

Add Google account ➔ p. 34

Kids Accounts

Kids profile (parental control) ➔ p. 39

Other Accounts

You can use other accounts within Google apps like YouTube, but you won't see recommendations for those accounts on the Google TV home screen. Privacy settings, such as location, that are applicable to the use of the device can be adjusted under Settings > Privacy.

Google Account

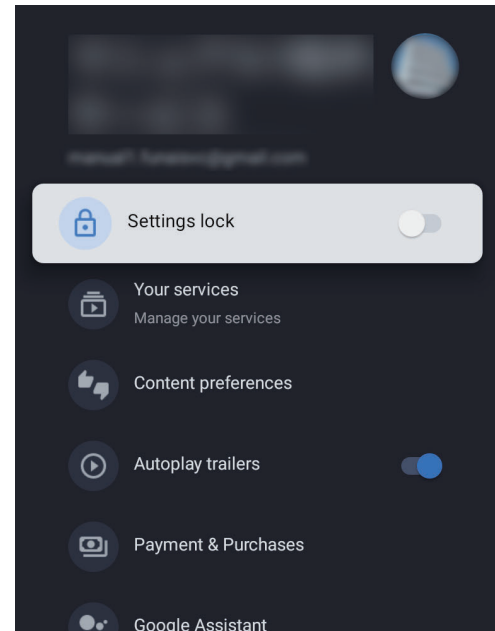

Settings lock

Turn this on to protect your settings. When on, you'll need to authenticate to view or change any account settings.

Your services

If you subscribe to streaming services, you can add them to your Google TV device or app. When you add services to your account, you get more recommendations on what to watch for those services. If a service offers multiple subscription options, to get accurate recommendations, you'll need to link that service to your Google Account.

- 1 Scroll right and turn each service on or off.
- 2 To save the selection and exit the screen, scroll left.

Content preferences

To get recommendations that are more relevant to you, there are a few things you can do.

Important: These options aren't available for all shows and movies on every streaming service.

- 1 Rate the suggestions.
- 2 To exit, on your remote, press **HOME** or **BACK**.

Autoplay trailers

Automatically play video trailers for shows and movies.

Payment & Purchases

Manage your account and purchases through the Play Store app on your mobile device, or by following these links in a Web browser.

Google Assistant

Personal results: Some Google Assistant devices, like speakers, Smart Displays, Smart Clocks, TVs and the Pixel Stand, can be shared with multiple people. For any shared device, you can turn on personal results to allow the Google Assistant to read or show results specific to you. For example, the Google Assistant may show:

- Results from your Gmail, Google Calendar, and Google Photos
- Recommendations for recipes based on your activity across other Google products
- YouTube Music personal playlists, liked songs, uploads, or library content

Important: The personal results setting doesn't control certain Assistant features provided by third parties like Spotify or Pandora.

On the Pixel Stand, some apps require you to unlock your phone even if you have personal results turned on.

SafeSearch filter: Whether you use Google Search at work, with children, or for yourself, SafeSearch can help you filter explicit content from your results. Explicit results include sexually explicit content like pornography, violence, and gore.

Apps only mode

Want to remove content recommendations on your home screen to simplify your Google TV experience? Turn on "Apps Only Mode" to display only your favorite installed apps.

Remove

Removing this account will delete all the related data from your device including associated kids accounts.

Privacy

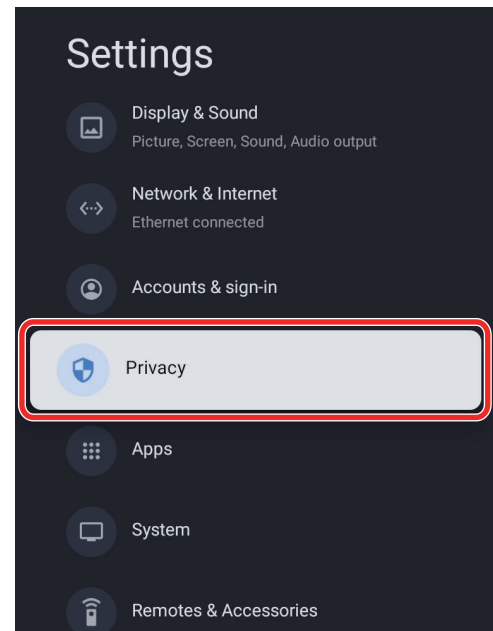

- 1 From the Google TV home screen, in the top right, go to the profile icon and select **Settings**.
- 2 Go to **Privacy**
This section is privacy settings of your TV, Google account and applications.

Location

- Google may collect location data periodically and use this data in an anonymous way to improve location accuracy and location-based services.

Usage & diagnostics

- Automatically send diagnostic information to Google, like crash reports and usage data from your device, apps, and Chromecast built-in. you can adjust these permissions at any time from device settings. Learn more at g.co/tv/diagnostics.

Ads

- Manage your ads settings, such as resetting your advertising ID.

Google Assistant ➞ p. 43

Payment & Purchases

- Manage your account and purchases through the Play Store app on your mobile device, or by following these links in a Web browser:
 - Payment methods [g.co/ManageWallet](https://www.google.com/ManageWallet)
 - Order history [g.co/Play/Order](https://www.google.com/Play/Order)
 - Subscriptions [g.co/Play/Subscriptions](https://www.google.com/Play/Subscriptions)

App permissions

Special app access

Security & Restrictions

- Your device and personal data are more vulnerable to attack by apps from unknown sources. You agree that you are solely responsible for any damage to your device or loss of data that may result from using these apps.

Apps

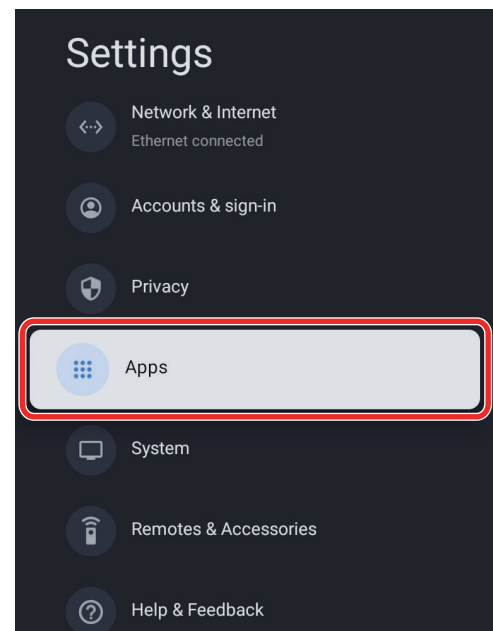

1 From the Google TV home screen, in the top right, go to the profile icon and select **Settings**.

2 Go to **Apps**

This section is apps settings, such as checking details and permissions.

Recently Opened Apps

Force stop

- If you force stop an app, it may misbehave.

Uninstall

- The application and its data will be removed from all users on the device.

Clear data

- All this app's data will be deleted permanently. This includes all files, settings, accounts, databases, etc.

App permissions

Special app access

Security & Restrictions

System

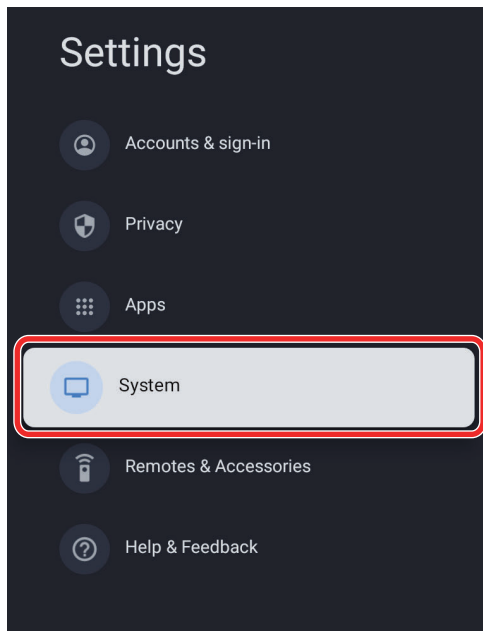

Turn on closed captions

Your caption preferences might not apply to certain apps.

- 1 From the Google TV home screen, in the top right, go to the user profile icon and select **Settings**.
- 2 Select **System > Accessibility**.
- 3 Select **Captions**.
- 4 Turn on Display to show captions. Then choose your options.

Display	Off	Closed caption is not displayed.
	On	Closed caption is always displayed.

You can choose the size, font, color, background and other characteristics of the caption text.

Language	<input type="radio"/> Default <input type="radio"/> English (Canada) <input type="radio"/> English (United States) <input type="radio"/> Español <input type="radio"/> Français
----------	---

Text size	<input type="radio"/> Very small <input type="radio"/> Small <input type="radio"/> Normal <input type="radio"/> Large <input type="radio"/> Very large
-----------	--

Accessibility

You can use a screen reader, closed captions, Switch Access, and more to make your Google TV device more accessible.

- 1 Press **HOME** and use **▲▼◀▶** to select **Settings** then press **OK**.
- 2 Use **▲▼** to select **System**, then press **OK**.
- 3 Use **▲▼** to select **Accessibility**, then press **OK**.
- 4 Adjust the following items.

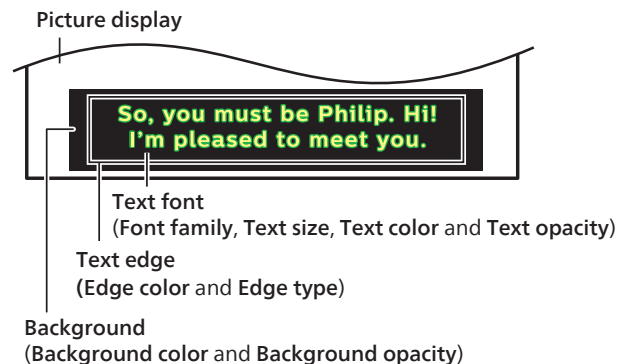

- Review your setting choice made above by looking in the bottom left corner of the displayed setting box (not all selections show the differences selected).

Turn on high contrast text

- 1 From the Google TV home screen, in the top right, go to the user profile icon and select **Settings**.
- 2 Select **System > Accessibility**.
- 3 Turn on High contrast text (Experimental).

Text to speech

Text to speech output settings.

To set On/Off of this function, select and set **TalkBack**.

Use accessibility shortcuts

Accessibility shortcuts are a quick way to turn on accessibility features. To use accessibility shortcuts, you first need to turn them on.

To turn on accessibility shortcuts:

- 1 From the Google TV home screen, in the top right, go to the user profile icon and select **Settings**.
- 2 Select **System > Accessibility**.
- 3 Select **Accessibility shortcut > Enable accessibility shortcut**.
- 4 By default, the shortcut turns on **TalkBack**. To change what's included in the shortcut, choose **Shortcut service**.
- 5 Choose an option and select **OK**.

To use the shortcut:

On your remote, press and hold the back arrow and down buttons at the same time for 3 seconds.

TalkBack

TalkBack is the Google screen reader included on Android devices. TalkBack gives you spoken feedback so that you can use your device without looking at the screen.

Change screen reader settings

- 1 From the Google TV home screen, scroll up to the top navigation bar.
- 2 Select **Profile Settings > Dashboard > Settings**.
- 3 Select **System > Accessibility**.
- 4 Under "Services," select **TalkBack > Configuration**.
- 5 Change settings for speech volume, verbosity (such as keyboard echo and usage hints), and spoken passwords.

Note(s)

To find more options and settings for TalkBack, such as speech rate and intonation, in the Accessibility menu, select **Text to speech**.

Use a screen reader

- 1 From the Google TV home screen, scroll up to the top navigation bar.
- 2 Select **Profile Settings > Dashboard > Settings**.
- 3 Select **System > Accessibility**.
- 4 Under "Services," select **TalkBack > Enable > OK**.

Turn on Switch Access

- 1 From the Google TV home screen, in the top right, go to the user profile icon and select **Settings**.
- 2 Select **System > Accessibility**.
- 3 Under "Services," select **Switch Access > Enable > OK**.

How Switch Access works

Switch Access scans the items on your screen, highlighting each item in turn, until you make a selection.

To use Switch Access, you'll first need one or more switches. There are several kinds of switches:

- **Use an external switch:** A switch is a device that sends a keystroke signal to your Android device. Several companies sell these devices, such as AbleNet, Enabling Devices, RJ Cooper, and Tecla. These devices connect to your Android device via USB or Bluetooth. (Neither Google nor Philips nor Funai endorse these companies or their products.)
- **Use an external keyboard:** You can configure a standard USB or Bluetooth keyboard to work as a switch device by assigning one or more of its keys to actions.
- **Use buttons on your Android device:** Built-in buttons on your Android device, such as the volume up and volume down buttons, can also be assigned to actions. This option is intended for developers.

About

You can check system update and TV registration information.

System update

Check for update

Device name

Naming your television will help you identify it and distinguish it from other devices for casting. Example: "Living Room TV"

Reset

This will restore your device to default settings and erase all data, accounts, files, and downloaded apps.

Status

Network, serial numbers and other information

Legal information

Confirm legal information.

Model

Confirm Model

Android TV OS version

Smart TV operating system number

Android TV OS security patch level

Confirm Android security patch level

Kernel version

Confirm Kernel version

Android TV OS build

Netflix ESN

Confirm Netflix ESN

Software Version

Confirm Software version

Date & Time

Automatic date & time

Use network-provided time or off

If it is set to off, please manually set the date and time.

Set date

Set time

Set time zone

Select your time zone

Use 24-hour format

Set the time to display in a 12 or 24-hour format

Language

You can set the language for the on-screen display.

- 1 Use ▲▼ to select **Language**, then press OK.
- 2 Use ▲▼ to select **English (Canada)**, **English (United States)**, **Español** or **Français** then press OK.

Note(s)

- If you need the English menu instead of the Spanish or French menu's, press **HOME**.
Use ▲▼◀▶ to select **Settings**, then press OK.
Use ▲▼ to select **Language**, then press OK.
Use ▲▼ to select **English**, then press OK.
Press **HOME** to exit the Home menu.

Keyboard

Perform the keyboard setting.

Storage

Internal shared storage

Removeable storage

Ambient mode (Digital Photo Frame)

Google TV lets you set your TV to scroll through Google Photos when you're not watching anything.

Ambient mode (Digital Photo Frame) → p. 42

Power & Energy

Power on behavior

Select the screen to start when powering on the TV.

Energy saver

Power

Timer

Cast

Cast to Google TV

You can cast content from phones, tablets, or laptops to your Google TV.

Cast to Google TV → p. 43

System sounds

Retail mode

This is only for store use.

Recommend to set Off when use at home. Or the advertisement would be appeared when you watch TV.

Restart

It just makes the TV turn off and again on. Your all settings will be kept. If you want to delete all settings of the TV, please do factory reset.

Settings > System > About > Reset > Factory reset

* This will restore your device to default settings and erase all data, accounts, files, and downloaded apps.

Remotes & Accessories

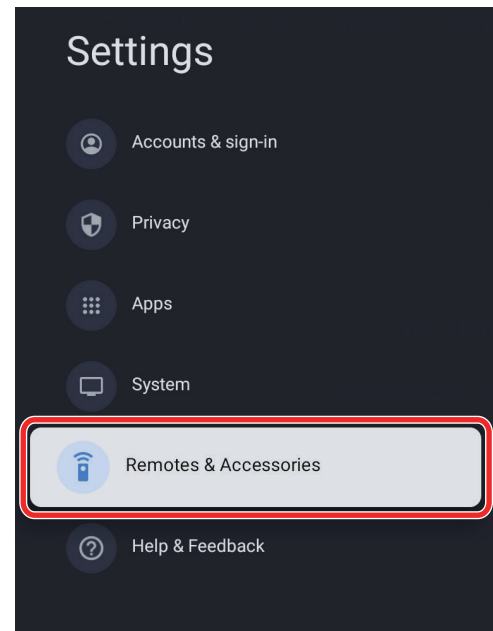

You can connect several Bluetooth devices, like headphones or game controllers, to your Google TV. You can only connect one audio device at a time.

Pair a Bluetooth device

- 1 From the Google TV home screen, in the top right, go to the profile picture or initial and select **Settings > Remote & Accessories > Pair accessory**
- 2 Make sure your device is in pairing mode or is visible to other devices.
- 3 Identify the device you want to pair from the list and select it.
- 4 On the Bluetooth pairing request screen, select Pair.

Note(s)

Accessories that have been paired with your device appear in the Remote & Accessories section of Settings. You can also rename or forget devices.

Reconnect a paired device

- 1 From the Google TV home screen, in the top right, go to the profile icon and select **Settings > Remote & Accessories**
- 2 Under "ACCESSORIES" choose your device.
- 3 Select Connect.

Fix problems with connecting Bluetooth devices

If your Bluetooth device won't connect, it could be an issue with the Bluetooth device or your TV.

Troubleshoot connection issues

- 1 Turn off your Bluetooth device and then turn it back on. After your device is reset, try to pair it again.
- 2 If you have multiple devices paired with your TV, disconnect the ones you're not using.
- 3 Unplug your TV for 10 seconds and then plug it back in. When your TV is on, try to pair it again.
- 4 Check if your Bluetooth device connects to other devices, such as a phone or tablet.
 - A. If your device connects to other devices: Reset your Google TV device to factory settings.
 - B. If your device doesn't connect to other devices: Check that your Bluetooth device has up-to-date software or get help from the device's manufacturer.

Help & Feedback

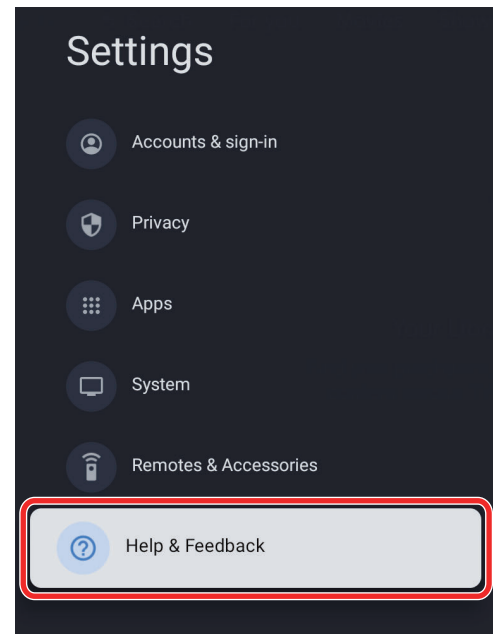

Help

Philips support app assisting you with trouble shooting.

Send feedback

Leave product feedback or share your ideas

5 Enhance your Google TV

Home menu

Google TV is TV personalized for you. Easily browse content from across your favorite apps and services, with specially curated recommendations based on your interests.

What you find on the Google TV home screen depends on where you live and the language you choose for your device.

- If you use a Google TV device in a country other than the one where you purchased it, your experience may vary.
- In some regions or territories, your experience may vary.

If you choose English, French, or Spanish as your language, you'll find these tabs:

- 1 Search**
Search movies, shows, apps and more.
- 2 For you**
Google TV home screen aggregates the best content from user's services.
- 3 Live tab**
See what's live on TV across different service providers in one menu. To watch live TV, download an app from your TV service provider (if available). This service is available only in the U.S.
- 4 Movies and Shows tab**
Discover new movies and shows with suggestions based on what you've watched and what interests you.
- 5 Apps tab**
Access your installed apps library or find new ones based on what you use or download.
- 6 Library tab**
Find movies and TV shows you've added in your Watchlist or rented through the Google TV store or YouTube.
- 7 Dashboard**
Google TV dashboard provides a single location for users to access settings, notifications, and kids mode.

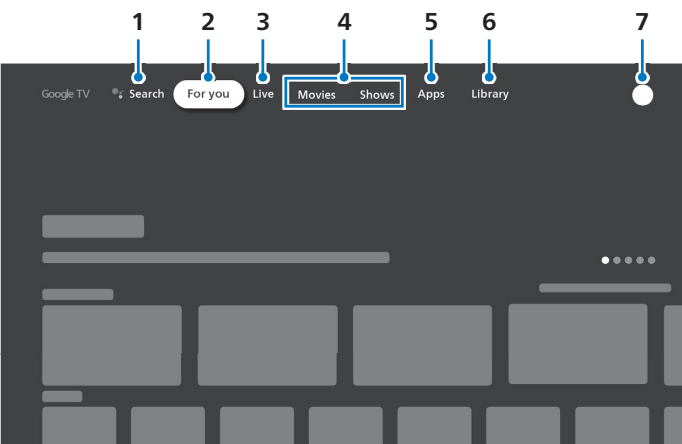

If you choose a different language or other countries, you'll find these tabs:

- Home
- Apps
- Library

Add Google account

You can add more than one account on your Google TV so you can sign in to services with multiple accounts. Your media and activity sync across devices that your Google Account is signed in to.

Sign in or add an account

Important: If you use an enterprise account, like one for work or school, some services might not work. For more information, contact your organization's administrator.

- 1 From the Google TV home screen, in the top right, go to the profile picture or initial and select **Settings**.
- 2 Go to **Accounts & sign-in** and select **Add another account**.
- 3 Sign in to the Google Account you want to add.

Note(s)

You can use other accounts on Google TV apps like YouTube, but recommendations on the Google TV home screen are based on the primary account's activity.

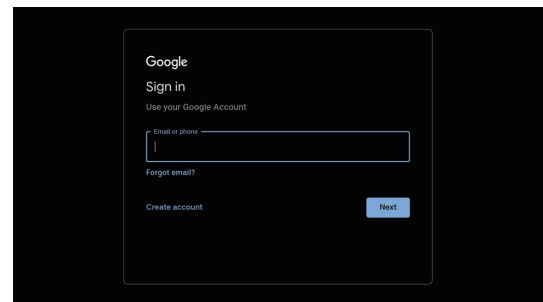

Remove or manage accounts

- 1 From the Google TV home screen, in the top right, go to the user profile picture or initial and select **Settings**.
- 2 Go to **Accounts & sign-in** and select the profile you want to remove.
- 3 Select **Remove > Remove account**.



Remove your account if you can't use your TV screen

- 1 On a phone or computer, go to your device in your Google Account.
- 2 Make sure you're signed in to the same account as on your Google TV device.
- 3 Choose the Google TV device you want to remove your account from.
- 4 Select **Sign out**.

Installing apps

You can install apps on your Google TV for your streaming services and other entertainment providers.

Search for an app

- 1 Press and hold the  Assistant button on your remote or select  Search on the home screen.
- 2 Say or type the name of the app you want to install.
- 3 If the app is available, a page will appear with the app.
- 4 Select **Install**.

Browse for apps

- 1 From the Google TV home screen, at the top, scroll to **Apps**.
- 2 To browse for apps, move up or down to find different categories. When you find a category you're interested in, move to the right to find items. You can also select a category from the "App categories" section.
 - To find apps you already use, scroll down to "Apps from my other devices."
- 3 Select the app or game you want.
- 4 To install the app or complete your purchase, follow the on-screen instructions.

Note(s)

- If you have trouble with your purchase, try a different payment method, like a credit card or PayPal.

Remove apps

- 1 From the Google TV home screen, scroll to **Apps**.
- 2 Scroll down to the "Your apps" section and find the app you want to uninstall.

Note(s)

- If you can't find the app, scroll all the way to the right and select **See all**.

- 3 Hold the "OK" button on your remote until a menu appears.
- 4 Select **View details > Uninstall**.

Personalized recommendation

To get recommendations that are more relevant to you, there are a few things that you can do.

Important: These options aren't available for all shows and movies on every streaming service.

Add your streaming services

Important: When you add streaming services on Google TV, you'll get more recommendations from those services. We recommend that you only select services that you subscribe to.

- 1 From the Google TV home screen, scroll to your profile picture and select **Settings**.
- 2 Select **Accounts & sign-in**.
- 3 Select your account > **Your services**.
- 4 To add your services, scroll right and turn on each service.
- 5 To save the selection and exit the screen, scroll left.

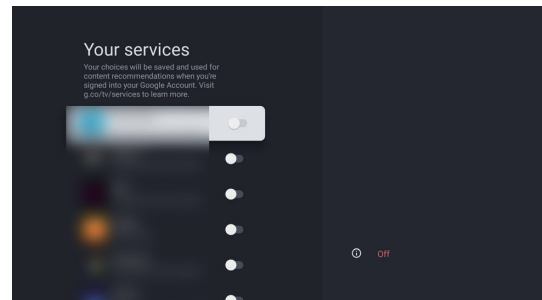

Tell us what you like to watch

- 1 From the Google TV home screen, scroll to your profile picture and select **Settings**.
- 2 Select **Accounts & sign-in**.
- 3 Select your account > **Content preferences**.
- 4 Rate the suggestions.
- 5 To exit, on your remote, press **HOME** or **BACK**.

Manage your watchlist

Important: Google uses the shows and movies on your watchlist to learn what you like to watch. You'll get recommendations for content that's similar to the titles on your watchlist.

- 1 Search or browse for the title that you want to add to your watchlist.
- 2 Open the title's details page.
- 3 Select 'Watchlist' +.

Note(s)

- When you add something to your watchlist, it's on the watchlist of all your devices logged in to the same account.

Mark what you've watched

- 1 Search or browse for a movie or show that you've seen before.
- 2 Open the title's details page.
- 3 Select Watched it?
For example, if you saw a movie in cinemas, you can mark 'Watched it'. Then, Google will recommend other movies and shows based on what you watched.

Rate movies and shows

- 1 On your Google TV, search or browse for a movie or show.
- 2 Open the title's details page.
- 3 Scroll right and choose 'Like' 👍 or 'Dislike' 👎.

Hide recommendations

If you want to hide personalized recommendations on Google TV, you can turn on Apps only mode. For example, when you have guests, you can use Apps only mode to hide your personalized recommendations.

Turn on Apps only mode

- 1 On a Google TV device, from the home screen, scroll right to your profile and select **Settings**.
- 2 Select **Accounts & sign-in**.
- 3 Select the primary Google TV account.
- 4 Select **Apps only mode > (on/off toggle) > Turn on**.
- 5 To browse in Apps only mode, on your remote, select **HOME**.

Exit Apps only mode

- 1 On a Google TV device, from the home screen, scroll right to your profile and select **Settings**.
- 2 Select **Accounts & sign-in**.
- 3 Select the primary Google TV account.
- 4 Turn off **Apps only mode**.

Watch your movies & shows in Apps only mode

You won't find your Library on your TV's home screen, but you can find it in the YouTube app: 

- 1 On your TV, open the YouTube app.
- 2 Go to **Library > Purchases**.

Note(s)

You can also cast content from your phone to your TV.

What happens when Apps only mode is on

In Apps only mode, you don't get personalized recommendations on your home screen. You'll find a list of installed apps that you can open to find something to watch. You'll also find sponsored content and teasers for popular movies and shows.

If Web & App Activity is on, Google TV will continue to improve recommendations for you, even while Apps only mode is on. In addition, apps can still show you their personalized recommendations based on your history. This includes YouTube, YouTube TV, and other Google apps.

Some features aren't available in Apps only mode. For example:

- You can't use Search or the Google Assistant.
- You can't "like" or "dislike" content, add videos to your Watchlist, or mark videos as watched.

Note(s)

Privacy settings such as location don't change. To change privacy settings, on your Google TV, go to **Settings > Privacy**.

Basic TV mode

You can only use basic TV on TVs that come with Google TV built in.

If you choose basic TV when you set up your Google TV device, you can:

- Finish setup faster
- Use your device without a Google Account
- Use your device without an internet connection
- Without an internet connection, your device won't get important security updates.
- * Some features aren't available in basic TV.

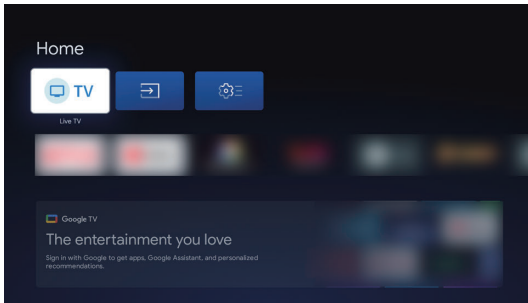

Basic mode

Switch from basic TV to Google TV

- 1 From the home screen, scroll to the Google TV banner.
- 2 Select Set up Google TV.
- 3 Follow the on-screen instructions to set up with the Home app or your remote.

Note(s)

- If you already set up Google TV, you can't switch to basic TV. To start setup again, you can factory reset your device.

What you can do in basic TV

- Watch TV through your cable service, satellite, TV tuner, or antenna with the TV app
- Play media from other inputs plugged into the TV
- Use a limited set of apps that come pre-installed on your device

What you can't do in basic TV

- Use services and features that require you to sign in to your Google Account
- Access your Play Library
- Install apps
- Use the Assistant to search for content
- Cast content from another device

Live TV/EPG

You can watch not only the broadcasting programs through integrated TV tuner but also from internet based service providers like Pluto TV, Youtube TV, Sling TV, Philo.

The Favorite channels help reduce the option set based on your interest, leading to more rapid decision making. You can add your own favorite channels and show them on Program Guide section of Live TV tab.

To set up TV channels, go to **Add channels** → p. 22

Program Guide

To view the latest TV program schedule, press  **GUIDE** on your remote.

Live TV from broadcasting

On the Google TV home screen, select the TV icon and then the programs start. Alternatively press  **INPUT** on your remote and select "TV".

Note(s)

- Live TV is only compatible with antenna select cable broadcasting. To watch your TV from cable set-top box, press  (**INPUT**) and select External Device.

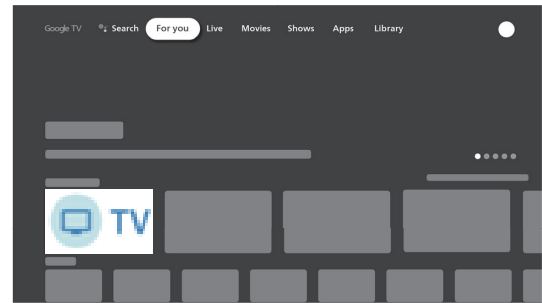

Choose your favorite channels

- 1 On your Google TV, go to the Live tab.
- 2 In the "All channels" view, find a channel you want to set as one of your favorites.
- 3 Navigate to the channel name and select it. A star will show up to confirm that the channel is now in your favorites.
- 4 To browse what's playing on your favorite channels, switch from the "All channels" view to the "Favorite channels" view.

Note(s)

- To remove a channel from your favorites, navigate to the channel name and select it. The star will disappear, and the channel will be removed from your favorites.

Program guide

To view the latest TV program schedule, press  **GUIDE** on your remote.

Program guide may contain 3rd party streaming program such as Youtube TV, Pluto TV.

Live TV from streaming providers

On the Google TV home screen, scroll to the "Live" tab.

To watch live TV, download an app from your TV service provider if one's available.

Note(s)

- If you're in the United States, live TV can also appear in the Live section of your home screen after you add a service provider and complete the necessary steps.

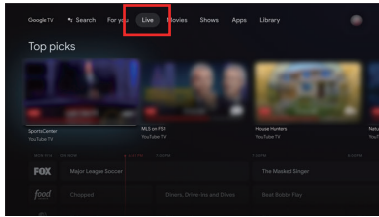

* The illustration may differ depending on the product you purchase.

Pluto TV

Live TV channels are available at no charge from Pluto TV. You can browse Pluto TV channels in the Live tab, your recommendations, and search results. To watch Pluto TV channels, you must install the Pluto TV app.

YouTube TV

On your Google TV, make sure the primary account is the same one you use for your YouTube TV subscription. If they're not the same, you can:

- Change the primary account on Google TV.
- Change your YouTube TV subscription to use your primary account.
- Use Google Families to link the 2 accounts.

Note(s)

- If you select YouTube TV as one of your streaming services, you may get YouTube TV recommendations in Google TV.

Sling TV

- Download the Sling TV app.
- Link Sling TV to your Google Account.

Philo

- Download the Philo app.
- Add Philo to your list of services.

TV options

Press  **OPTIONS** to set up the TV options.

Inputs

Inputs  p. 21

Picture

Picture  p. 22

Screen

Sound

Sound  p. 23

Closed captions

Captions (Antenna/Cable)

Display	Off	Closed caption is not displayed.
	On	Closed caption is always displayed.
	CC w/ mute	Closed caption is displayed when the sound is off.

Caption service	CC-1 and T-1	The primary closed captions and text services. The closed captions or text is displayed in the same language as the program's dialog (up to 4 lines of script on the TV screen).
	CC-3 and T-3	Serve as the preferred data channels. The closed captions or text is often a secondary language.
	CC-2, CC-4, T-2 and T-4	Rarely available and broadcasters use them only in special conditions, such as when CC-1 and CC-3 or T-1 and T-3 are not available.

In addition to the basic closed caption, DTV has its own closed caption called digital caption service. Use this menu to change the settings for digital caption service.

Advanced selection	CS-1 to CS-6	Select one of these before changing any other item in Captions (Antenna/Cable) menu. Choose CS-1 under normal conditions.
--------------------	--------------	--

Note(s)

- Caption service that you can switch differs depending on the broadcast description.
- Closed captioning service may not be controlled by this unit's menu options if you are watching television through an external cable or satellite set-top box. In which case you will need to use the menu options on the external set-top box to control closed captioning.
- The captions do not always use correct spelling and grammar.
- Not all TV programs and product commercials include closed caption information. Refer to your area TV program listings for the TV channels and times of closed caption shows. The captioned programs are usually noted in the TV listings with service marks such as CC.
- Not all captioning services are used by a TV channel during the transmission of a closed caption program.
- Closed caption will NOT be displayed when you are using an HDMI or a component connection.
- To show the closed caption on your TV screen, broadcast signal must contain the closed caption data.
- Not all TV programs and commercials have the closed caption or all types of the closed caption.
- Caption's and text may not exactly match the TV voice.
- Changing channels may delay the closed caption for a few seconds.
- Adjusting or muting the volume may delay the closed caption for a few seconds.
- Abbreviations, symbols and other grammatical shortcuts may be used in order to keep pace with the on-screen action. This is not a malfunction.
- The caption or text characters will not be displayed while the Main menu or functions display is shown.
- If a black box appears on the TV screen, this means that the closed caption is set to the text mode. To clear the box, select **CC-1**, **CC-2**, **CC-3** or **CC-4**.
- If the unit receives poor quality television signals, the captions may contain errors or there might be no captions at all. Some possible causes of poor quality signals are:
 - Automobile ignition noise
 - Electric motor noise
 - Weak signal reception
 - Multiplex signal reception (ghosts or screen flutter)
 - Data dropout and pixelation (for DTV only)
- The unit retains the closed caption setting if the power fails.
- When the unit receives special effects playback signal (e.g. search, slow and still) from a VCR's video output channel (ch3 or ch4), the unit may not display the correct caption or text.
- The EUT setting that satisfies § 79.102 (e) is as follows:
 - Font: Mono-font
 - Character size: Large

Multi audio

English, Espanol, Francais

This item is displayed when DTV broadcasting is received.

- Mono
- Stereo
- SAP

This item is displayed when ATV broadcasting is received.

Power

Power ⇨ p. 32

Parental Controls

Parental Controls ⇨ p. 41

Advanced Options

- Audio
- Closed captions
- No Signal Auto Power Off
- Open Source Licenses

Settings

Channels & Inputs ⇨ p. 22

Kids profile (parental control)

Set up a kids profile on Google TV to choose which apps your kids can use, and to set up bedtime reminders and screen time limits.

* Kids profiles may not be available in some regions or on some devices.

Add a kids profile

- 1 From the Google TV home screen, in the top right, go to the profile icon and select your profile.
- 2 Under "Choose an account" select **Add a kid > Get started**.
- 3 Under "Welcome parents" select **Get started**.
- 4 Select an option:
 - **If your child has a Google Account or kids profile in your family group:** Select the child you want to set up.
 - **If you haven't set up a child in your family group:** Select Add a kid and follow the on-screen instructions.
- 5 Choose the apps you want to include in the kid's home screen.
- 6 To set up parental controls, follow the on-screen instructions.

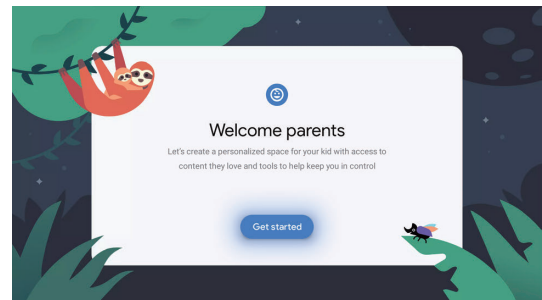

Switch to a kids profile

- 1 From the Google TV home screen, in the top right, go to the profile icon and select your profile.
- 2 Select the kid's profile.

Set up a profile lock

Important: With a profile lock, you have to enter the adult's Google Account PIN or password to exit a kids profile. This is the same PIN or password that you use for Google Pay and other Google services.

- 1 From the Google TV home screen, in the top right, go to the profile icon and select **Settings**.
- 2 Go to **Accounts & sign-in** and select your kid's profile.
- 3 Select Profile lock and enter your Google Account PIN or password.
- 4 To turn on "Profile lock".

Allow or block content or apps

Allow or hide apps

- 1 From the Google TV home screen, in the top right, go to the profile icon and select Settings.
- 2 Go to **Accounts & sign-in** and select your kid's profile.
- 3 Select Manage apps.
 - **To allow apps:** Next to the app, check the blue box. Apps are installed automatically.
 - **To hide apps:** Next to the app, uncheck the blue box.

Allow or block content in your library based on rating

Important: This only works for content purchased from Google and shared with your kid. This setting doesn't apply in apps.

- 1 From the Google TV home screen, in the top right, go to the profile icon and select Settings.
- 2 Go to **Accounts & sign-in** and select your kid's profile.
- 3 Select Family Library.
- 4 Set the maximum allowed rating for Movies and TV.

Set a daily screen time limit

- 1 From the Google TV home screen, in the top right, go to the profile icon and select Settings.
- 2 Go to **Accounts & sign-in** and select your kid's profile.
- 3 Select Screen time and then Daily limit.
- 4 Select the days you'd like to schedule a daily limit.
- 5 Choose how many hours your kid can watch TV each day.
 - You can set limits in intervals of 15 minutes, up to 8 hours.

Set a daily bedtime

- 1 From the Google TV home screen, in the top right, go to the profile icon and select Settings.
- 2 To select the kid's profile, go to **Accounts & sign-in**.
- 3 Select Screen time and then Bedtime.
- 4 Select the days you'd like to schedule a bedtime.
- 5 Select when your kid's TV time should start and end.
 - Times are available in intervals of 30 minutes.

Add bonus time

When the daily watch time for your kid ends, you can add bonus time:

- 1 From the timeout screen, select **More time** and enter your Google Account PIN or password.
- 2 Select how much bonus time to add.
 - You can add bonus time in intervals of 15 minutes, up to 8 hours.
- 3 To confirm the bonus time, enter your Google Account PIN or password.

Report inaccurate content ratings

- 1 From your child's profile, highlight the content with the inaccurate rating.
- 2 On your remote, hold the select button.
- 3 Select Report inaccurate rating.

Hide library content

- 1 From your child's profile, highlight the content you want to hide.
- 2 On your remote, hold the select button.
- 3 Select Hide.

Unhide library content

- 1 From the Google TV home screen, in the top right, select the profile icon and then Settings.
- 2 Select **Accounts & sign-in** and then your kid's profile.
- 3 Select Hidden movies & TV shows.
- 4 Find and select the content you want to unhide.
- 5 Select Show to unhide the content.

Parental Controls

You can restrict your children from watching certain programs or channels, by setting parental controls using a rating lock.

Other separate restrictions may be available depending on the app.

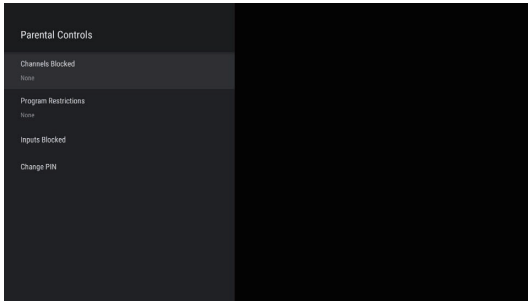

- 1 On the Live TV screen, press **≡(OPTIONS)** on your remote and select **Parental Controls**.
- 2 Enter your **PIN (*)** > **Program Restrictions** > **on** > **Ratings**.
- 3 Select the rating type as described in the table below and press **OK**.

Note(s)

- Default setting of PIN is "1234".
- If you have forgotten the current 4-digit PIN code, you can reset the code by performing Factory data reset.
- **Program Restrictions** is displayed only when the last selected input is not HDMI.

Rating types and restriction levels

	United States					
	TV-Y	TV-Y7	TV-G	TV-PG	TV-14	TV-MA
High Restrictions Content suitable for children		✓		✓	✓	✓
Medium Restrictions Content suitable for children				✓	✓	✓
Low Restrictions Content suitable for teens						✓

	United States (Film ratings)					
	G	PG	PG-13	R	NC-17	X
High Restrictions Content suitable for children			✓	✓	✓	✓
Medium Restrictions Content suitable for children			✓	✓	✓	✓
Low Restrictions Content suitable for teens						✓

Use Phone as remote/Watchlist

Use your phone as your Google TV remote

You can use the Google TV app on your Android phone as the remote to navigate your Google TV.

The Google TV app is only available on Android phones in select countries.

With the virtual remote, you can:

- Navigate the TV screen
- Control media
- Turn the TV on or off
- Activate the Google Assistant
- Change the volume
- Enter text to perform searches or enter login information

Set up your virtual remote

- 1 On your Android phone, open the Google TV app .
- 2 Near the bottom right, tap Remote
- 3 At the top, tap Scanning for devices.
- 4 Choose your device.
- 5 To complete pairing, follow the instructions on your phone and TV.
- 6 After pairing, you can use your phone or your remote.

Fix problems with the Google TV virtual remote

Check your Wi-Fi connection

To use your phone as a remote, your phone and TV must be on the same Wi-Fi network.

To check or change the connection on your TV:

- 1 From the Google TV home screen, in the top right, go to the profile icon and select Settings.
- 2 Select Network & Internet.
- 3 Confirm that Wi-Fi is turned on and you're connected to the correct network.
 - If necessary, select the network you want to connect to.
 - If necessary, enter the password.

To check or change the connection on your phone:

- 1 On your phone, open the Settings app.
- 2 To find your network or choose a different network, tap Network & internet > Wi-Fi.

Ambient mode (Digital Photo Frame)

Change the screen saver

Google TV lets you set your TV to scroll through Google Photos when you're not watching anything.



You must be signed in to your Google account in order to set up and configure Ambient Mode.

With the ambient-mode cards, you can configure it to display information like sports scores, weather and news based on your profile. The feature also provides on-screen shortcuts to let you launch photos or start playing music and podcasts with one click.

Choose your screen saver

- 1 From the Google TV home screen, at the top right, go to the user profile icon and select **Settings**.
- 2 Select **System > Ambient mode**.
- 3 Choose what you want to show:
 - **Google Photos**: Choose photos or albums saved in your Google Photos account.
 - **Art gallery**: Choose featured photos, fine art, and more.
 - **Experimental**: Try out new sources and content.

Choose which photos show

- 1 On your phone, open Google Home .
- 2 Select your TV.
- 3 At the top right, tap **Settings**  > **Ambient mode** > **Google Photos**.

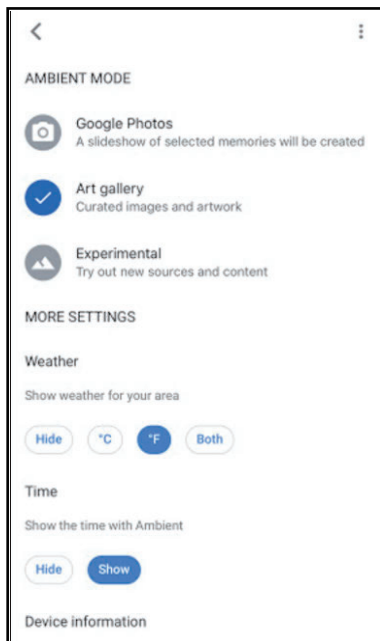

- 4 Select the photos or albums you want to show on your TV.

Customise settings

- 1 From the Google TV home screen, at the top right, go to the user profile icon and select **Settings**.
- 2 Select **System > Ambient mode**.
- 3 Under "More settings", choose:
 - **Personal photo data**: Show or hide the owner's name and album name.
 - **Portrait Google Photos**: Choose if photos can show in portrait orientation.
 - **Personal photo curation**: Choose which albums are included.
 - **Slideshow speed**: Choose how long a photo stays on the screen.

Show weather & time on your screen saver

- 1 From the Google TV home screen, at the top right, go to the user profile icon and select **Settings**.
- 2 Select **System > Ambient mode**.
- 3 Under "More settings", choose:
 - **Weather**: Choose **°C**, **°F**, or **Both**.
 - **Time**: Choose to show or hide the time.



Cast to Google TV

Cast to Google TV

You can cast content from phones, tablets, or laptops to your Google TV.

Cast from a device to your TV

Important: You can only cast from the latest version of a Chromecast-enabled app or a Chrome browser on a device connected to the same Wi-Fi network as your Google TV.

- 1 Connect your device to the same Wi-Fi network as your Google TV.
- 2 Open the app that has the content you want to cast.
- 3 In the app, find and select Cast .
- 4 On your device, select the name of your TV.
- 5 When Cast  changes color, you're successfully connected.
To stop casting, on your device, select Cast  > Disconnect.

Fix problems with casting

If you can't cast on your Google TV, try the solutions below.
Make sure casting is enabled on your TV

- 1 From the Google TV home screen, in the top right, go to the user profile icon and select **Settings**.
- 2 Select **Apps > See all apps**.
- 3 Find the app **Chromecast built-in**.
If you can't find it, select Show system apps or check in the "Disabled apps" section.
- 4 Check that the app is enabled. If it's not, select **Enable** to turn it back on.
- 5 To reboot your device, select **Settings > System > Restart**.

Connect your TV and device to the same Wi-Fi network

- 1 From the Google TV home screen, in the top right, go to the user profile icon and select **Settings**.
- 2 Under **Network & Internet**, find the name of the Wi-Fi network your TV is connected to. Make sure it's the same as the network on the device you want to cast from.

Update your TV

- 1 From the Google TV home screen, in the top right, go to the user profile icon and select **Settings**.
- 2 Select **System > About > System update**.
If an update is available, follow the on-screen instructions to install it.
You need to connect to internet to update your TV.

Google Assistant

Do more with Google Assistant on Google TV

You can ask questions and complete tasks on your Google TV with Google Assistant. Google Assistant comes installed on your Google TV device. You can turn it on when you first set up your device, or you can turn it on later.

On Google TV devices, Google Assistant is available in English, French, German, Spanish, Italian, and Japanese.

Talk to Google Assistant

Simply press and hold the Google Assistant button  on your remote as you ask a question or say a command to watch movies, open apps, set timer, check weather and more - using just your voice. To help Google Assistant understand your request, speak into the microphone on your remote.

What you can ask Google Assistant

Watch videos

- ① Movies and TV shows: "Play The Mandalorian on Disney+."
- ② Video clips: "Play cat videos on YouTube."
- ③ Apps: "Open YouTube."
- ④ Search: "Search for sitcoms." "Find sci-fi movies."
- ⑤ Info: "Tell me about Game of Thrones."

Control media

- ① Playback: "Pause." "Stop." "Resume."
- ② Volume: "Louder." "Softer."

Control your smart home

- ① Lights: "Dim the living room lights."
- ② Thermostats: "Set the heat to 70." "Lower the temperature 2 degrees."

Plan your day

- ① Alarms: "Set an alarm for 7 AM."
- ② Reservations: "Make a reservation for 2 at [restaurant] on Friday."

Ask Google

- ① Game updates: "Who won the Warriors game?"
- ② Calculations: "What's 20% of 80?"
- ③ Dictionary: "What does "gregarious" mean?"
- ④ Translations: "How do I say "Nice to meet you" in French?"
- ⑤ Finance: "How's the S&P 500 doing?"
- ⑥ Unit conversions: "How many kilometers in a mile?"
- ⑦ Search: "Search for summer vacation ideas."
- ⑧ Image search: "Find pictures of kittens."
- ⑨ Web answer: "How do you remove wine stains from a rug?"

Have fun

- ① Get to know your Assistant: "Do you dream?" "What's your favorite color?"
- ② Games: "Let's play a game." "Give me a trivia question."
- ③ Entertainment: "Tell me a joke." "Tell me something interesting."

 **Note(s)**

- For more ideas, ask Google Assistant, "What can you do?"

USB camera for Google Duo

Google Duo is an app that provides simple, high-quality video calls right from your TV. To start calling with Google Duo, below items are required:

- 1 10 Mbps or faster internet access for 1080p video call.¹
- 2 Google account²
- 3 External USB camera with a built-in mic which supports Android 11.0 and later.

Below USB camera is compatible³ with this Philips Google TV.

Brand	Model
Logitech	C920s
Logitech	C922

- 1 If connectivity issues arise, please turn on Data Saving Mode under **Settings > Call settings > Data Saving mode**. This reduces the necessary bandwidth as well as the call quality.
- 2 A Google account is required. Sign in with an existing account or create a new one. If there is one already signed in on your Android TV, select the account that you want to use.
- 3 Compatibility of USB cameras with this Philips Google TV may change over time with USB camera hardware and/or software updates.

For more details on how to get started, please visit https://support.google.com/duo/answer/10079968?hl=en&ref_topic=6376099



How to connect USB camera

Connect a USB camera with a built-in mic directly into your Google TV before launch Google Duo. Below is an example of how to connect and place USB camera. After you launch Google Duo, follow onscreen instructions to setup and configure settings of Google Duo including access to camera and mic.

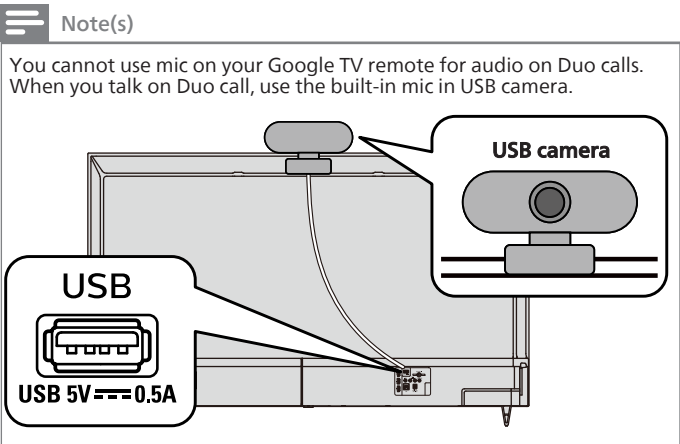

Google Duo	USB camera does not work	<ul style="list-style-type: none"> • Check if USB camera supports Android 9.0 or later. (May be listed on USB camera packaging or manufacturer's website) • Check if USB camera is connected to the TV. • Turn off the TV and disconnect/reconnect USB camera. Turn the TV back on and reopen the Duo app. • If issues remain, please visit the Duo support page and check the Troubleshoot section. (https://support.google.com/duo)
	Other party cannot hear anything (My microphone does not work)	<ul style="list-style-type: none"> • Check if USB camera has a built-in mic and supports Android 9.0 or later. (May be listed on USB camera packaging or manufacturer's website) • Check if your microphone is muted. (Please unmute if so) • Check if USB camera is connected to the TV. • Turn off the TV and disconnect/reconnect USB camera. Turn the TV back on and reopen the Duo app. • If issues remain, please visit the Duo support page and check the Troubleshoot section. (https://support.google.com/duo)
	I cannot hear other party (Speaker does not work)	<ul style="list-style-type: none"> • Check if the volume of the TV is muted or very low. (Please unmute or turn the volume up if so) • Check if USB camera is connected to the TV. • Turn off the TV and disconnect/reconnect USB camera. Turn the TV back on and reopen the Duo app. • If issues remain, please visit the Duo support page and check the Troubleshoot section. (https://support.google.com/duo)



Stadia gaming

Play Stadia on your TV

You can use Google TV to play games on Google Stadia. To get started, you need to [create a Stadia account](#) and [install the Stadia app on Google TV](#).

<https://stadia.google.com/>

Availability

Stadia works on compatible Google TV and Android TV devices. For the best experience, use an officially supported [Stadia-compatible gamepad and screen](#). Your experience may vary when you play with unsupported devices.

Stadia is only available in certain countries. [Learn more about Stadia availability in your country](#).

Connect a controller to your TV

To play Stadia on your TV, connect either the official Stadia controller or a [compatible Bluetooth controller](#).



Note(s)

- You can only use the Stadia controller to navigate the Stadia app. To navigate other sections of your TV's interface, use a Bluetooth controller or the remote that came with your device.

Connect a Bluetooth controller

- You can use Bluetooth to connect a gaming controller, and then use it to play Stadia games or navigate your TV's interface.
- Main compatible controllers: PlayStation® DualShock 4, Xbox One® and Xbox® Adaptive Controller. See for more compatible controllers [Stadia.google.com](https://stadia.google.com).

Connect a Stadia controller

- Connect your Stadia controller to the same Wi-Fi network as your TV. [Learn how to set up your Stadia controller](#).
 - If you use an external Google TV device, connect your controller to the same Wi-Fi network as your device and then select the corresponding HDMI input on your TV.
- Use your remote or a connected Bluetooth controller to launch the Stadia app.
 - If you can't find the app, you need to [install the Stadia app on Google TV](#).
- From the Stadia home screen, at the top right, select your avatar.
- Select the controller icon .
- Press and hold the Stadia button  until the controller turns on. After the controller vibrates twice and the button blinks white, release the button.
- Enter the linking code on your TV with the Stadia controller's buttons.

Troubleshooting your Stadia experience

If you experience slow game responses or degraded visual quality in your Stadia game streams, you might have a weak internet connection, a network issue, or a problem with one of your devices. These issues might result in problems with Stadia Pro features like 4K, HDR, or 5.1 surround sound.

Note(s)

Before you [troubleshoot](#), [test your internet connection](#) to make sure your connection speed is 10 megabits per second (Mbps) or greater. Even if you're signed up for an internet plan of 10 Mbps or greater, we recommend that you test your connection on the device you'll use in the location where you want to play.

Google TV, Android TV, or compatible smart TVs

- If you use Stadia with a separate Google TV or Android TV device, plug the device into an HDMI 2.0 (or greater) port on your TV. If possible, add an HDMI extender cable to create distance between the device and your TV.
- Turn on "Game Mode" in your TV's settings, if available. Check with your TV's manufacturer for instructions.
- Turn on the "Game Mode" setting on your Google TV or Android TV device, if it has one. For example, turn on the [Allow game mode](#) setting on Chromecast with Google TV.
- Turn off any setting on your Google TV or Android TV device that upscales content to 4K or modifies the dynamic range (like the [Match content](#) setting).
- Verify that your Google TV or Android TV device is set up for a 60Hz display refresh rate. You can check your refresh rate in your device's display settings.
- If you have a Bluetooth® controller, [pair it](#) to your Google TV, Android TV, or smart TV to play games on Stadia. If you experience connectivity issues with your controller, follow these steps:
 - Check that your Wi-Fi router is more than 2-3 feet from your streaming device or smart TV. If the router is too close to your device, it can cause issues with wireless signals.
 - If your router supports both 2.4 GHz and 5 GHz bands, make sure your streaming device or smart TV is on the 5 GHz band.
 - If you're more than 8-10 feet away from your TV and experience latency or dropout issues during gameplay, move closer to your TV.
 - Remove any objects between your controller and your streaming device or smart TV. These objects might block the signal.
 - If possible, connect your device to the internet with an Ethernet cable.

Stadia Controller connectivity

If your Stadia Controller is unresponsive or you experience missing or delayed button presses, try the following tips:

- 1 Use a functional charger and USB-CR cable to plug your Stadia Controller into a power source and charge it for 30 minutes.
- 2 Hardware reset your Stadia Controller.
- 3 With the controller off, hold down the Y button (Y) > press the Stadia button (Stadia) until the controller rumbles and the status light turns on.
- 4 [Set up your controller on your Wi-Fi network](#) with the Stadia app (Stadia) on your mobile device.
- 5 Turn off any Virtual Private Network (VPN) services you have enabled on your network.
- 6 Go into your Wi-Fi router's settings and make sure [Access Point \(AP\) Isolation](#) is disabled. This is also known as "client mode" or "guest mode". For more information, check with your router's manufacturer.

Note(s)

- AP Isolation is often enabled on public networks in places like hospitals, hotels, student dorms, or corporate networks. This setting can prevent your Stadia Controller and Chromecast from communicating with each other. If you're on a public network, check with your network administrator for more information.

- 7 Unplug your Wi-Fi router from a power outlet, then wait at least 30 seconds and plug it back in.
- 8 Turn off "Airtime Fairness," "Airtime Quality," or "Multimedia Quality of Service (WMM)," settings on your router. The name of this setting varies depending on your router manufacturer.

"Please check your connection"

What it means:

- **If you get this message before you start your game:** While your game launched, Stadia tested your connection and determined that it wasn't strong enough to play a game.
- **If you get this message because your game stopped:** Your connection wasn't strong enough to continue playing. For the next 10 minutes, you'll be able to return to where you left off in the game if you improve your internet connection.

6 Troubleshooting tips

If you can't play videos on your Google TV or have other problems with your Google TV device, try the steps below.

Basic issues

Step 1. Check your Wi-Fi connection

- 1 From the Google TV home screen, in the top right, go to the profile icon and select **Settings**.
- 2 Select **Network & Internet**.
- 3 Confirm that **Wi-Fi** is turned on and you're connected to the correct network.
- 4 If not, locate the network you'd like to connect to and select it to connect. Enter the password if required.
- 5 Open one of your apps.
- 6 Play your video, music, or game again.

Note(s)

If you still have issues, turn the Wi-Fi option off and on again. If that doesn't work, go to the next step.

Step 2. Check for system updates

- 1 From the Google TV home screen, in the top right, go to the profile icon and select **Settings**.
- 2 Select **System > About > System update > Check for update**
- 3 Install any available updates, then play your video, music, or game again. If that doesn't work, go to the next step.

Step 3. Restart your device

- 1 From the Google TV home screen, in the top right, go to the profile icon and select **Settings**.
- 2 Select **System > Restart**.
- 3 Once the system restarts, play your video, music, or game again. If it still doesn't work, go to the next step.

Step 4. Check which account you're signed in to

- 1 From the Google TV home screen, in the top right, go to the profile icon and select **Settings**.
- 2 Under **Accounts & sign-in**, check which account is signed in to Google TV.
- 3 Make sure it's the same account you used for your service.

Step 5. Clear app data

- 1 From the Google TV home screen, in the top right, go to the profile icon and select **Settings**.
- 2 Select **Apps > See all apps**
- 3 Find and select the **app > Clear data > OK**
- 4 Play your video, music, or game again. If that doesn't work, go to the next step.

Step 6. Reset the device to factory settings

Important: A factory reset erases all your data from your device. We recommend that you try to troubleshoot with other steps first.

- 1 From the Google TV home screen, in the top right, go to the profile icon and select **Settings**.
- 2 Select **System > About > Reset**

Network connections

Check your Wi-Fi connection

- 1 From the Google TV home screen, in the top right, go to the profile icon and select **Settings**.
- 2 Select **Network & Internet**.
- 3 Confirm that **Wi-Fi** is turned on and you're connected to the correct network.
- 4 If not, locate the network you'd like to connect to and select it to connect. Enter the password if required.
- 5 Open one of your apps.
- 6 Play your video, music, or game again.

Note(s)

If you still have issues, turn the Wi-Fi option off and on again.

Connect Remote control

Fix issues with your remote

Important: You might need to remove and reinsert the batteries on your remote.

If that doesn't solve the issue, try to update your remote.

On the Google TV home screen, open the **See all** and select the **Remote update** icon, and then the update starts.

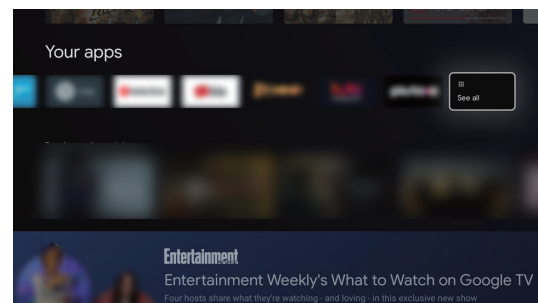

LED states on voice remote

The voice remote has an LED light **above** the **⏻ (POWER)**.

It tells you about the status of your remote.

Operation	LED behavior
Normal keys click	• LED turns on during pressing the keys.
Pairing Press any buttons when bonding cache is NULL. Or Press and hold [Google Assistant] and [VOL-] key for 3 seconds. [Pairing timeout] 30sec	• LED blink while pairing process. • LED fast blink 5 times when pairing completion.
UnPairing Press and hold [Google Assistant] and [VOL-]key for 3 seconds	• LED keep to light up fast blink 9times when UnPairing completion. [Operation] Bonding cache clear and sleep 3sec later.
Voice search Hold to Talk [Google Assistant]key	• LED turns on after ACK from host when voice search is ready. • LED turns off after end of speech is detected from the host, or LED turns off after 30 seconds of time out.

Pair a Bluetooth device

- 1 From the Google TV home screen, in the top right, go to the profile icon and select **Settings**.
- 2 Select **Remote & Accessories > Pair accessory**
- 3 Make sure your device is in pairing mode or is visible to other devices.
- 4 Identify the device you want to pair from the list and select it.
- 5 On the Bluetooth pairing request screen, select **Pair**.

Note(s)

Accessories that have been paired with your device appear in the Remote & Accessories section of Settings. You can also rename or forget devices.

Reconnect a paired device

- 1 From the Google TV home screen, in the top right, go to the profile icon and select **Settings**.
- 2 Select **Remote & Accessories**
- 3 Under "ACCESSORIES" choose your device.
- 4 Select **Connect**.

Video

Streaming movie often stops or starts buffering during playback.

- Contact your internet service provider to troubleshoot your internet connection for speed and line quality.
- Consistent line quality and speed are very important for internet video playback.

Slow Data Connection or buffering.

- Check the settings between your router and ISP modem or gateway (if applicable).
- Connect to a stable wireless connection from home wireless or wired network, check your wifi connection quality in settings

Note(s)

The use of mobile hot spots or public wireless connections is not recommended.

Power is on but screen image is off.

- Check if the connection for your source device is properly secured.
- Check if the correct input is selected by pressing **INPUT** on your remote.
- Verify that your HDMI mode, for the input selected matches the resolution output of your source device.
- Change source input until you have picture and sound.

Television has sound with no picture or abnormal picture.

- Change the resolution output of your source device.

Why are captions not displayed entirely? Or why are captions delayed behind the dialog?

Closed captions that are delayed a few seconds behind the actual dialog are common for live broadcasts.

Most captioning production companies can display a dialog to maximum of 220 words per minute.

If a dialog exceeds that rate, selective editing is used to insure that the closed captions remain up-to date with the current TV screen dialog.

Ghosts, lines or streaks in picture.

Electrical interference from nearby appliances may affect picture quality.

View other TV channels. The problem might be limited to the broadcasting station or weak signal strength.

Picture poor, sound intermittent or no sound

View other TV channels. The problem might be limited to the broadcasting station or weak signal strength.

How do I adjust the picture settings on my Television

For wired connection (HDMI)/Antenna cable/composites

- 1 Go **Setting/Dashboard** and select **Picture**
- 2 select **Picture Mode** and choose what you want

Why not seeing a picture or not seeing a correct resolution when connected with HDMI

- Check the antenna/cable connection.
- Connect the 4K (50p/60p)* playable device.
- Use a Premium High Speed HDMI™ Cable(s) that supports 18 Gbps.
- Set HDMI EDID Version to [EDID 2.0 or EDID 2.1] by selecting **Settings > Channels & Inputs > Inputs > HDMI EDID Version > the HDMI terminal you want to set.**
- Check whether the connected device has the latest settings or firmware.

The screen suddenly changes to a video you do not recognize while watching TV.

In this case, the TV might be in demo mode. Try exiting demo mode.

Press **Dashboard** on the remote control and select **Settings > System > Retail Mode**. Disable "Retail Mode".

Distorted picture./The screen flickers.

- Check the antenna/cable connection.
- Keep the antenna/cable away from other connecting cables.
- When installing an optional device, leave some space between the device and the TV.
- Make sure that the antenna is connected using a high quality 75-ohm coaxial cable.

High resolution HDR pictures are not displayed.

The following are required to watch high resolution HDR pictures such as 4K.

- Connect the 4K playable device.
- Use a Premium High Speed HDMI™ Cable(s) that supports 18 Gbps.
- Set "HDMI EDID Version". Select **Settings > Channels & Inputs > Inputs > HDMI EDID Version**. Select the correct version.
- Check whether the connected device has the latest settings or firmware.

Audio

Television has no sound.

- Please check to be sure the device is connected to the HDMI-2 (ARC) input on the TV.
- Check if the power is on.
- Check whether all the cables to the unit are connected to the correct output jack on your separate device like Blu-ray Disc™ / DVD recorder
- Unplug the AC power cord and wait for about 1 minute, then plug the AC power cord and turn on the unit again.
- Check whether the connection of the antenna or cable/satellite set-top box is connected correctly.
- Make sure that the sound is not muted. Press **MUTE** so that the volume bar and current volume level will appear on the TV screen.
- Make sure that the volume is NOT, set to 0 or **MUTE**. If so, use **+/- VOL** to adjust to the desired volume.
- Make sure that the headphone is NOT connected to the headphone audio output jack.
- If there are issues with picture/color and/or sound when connecting an external device using the HDMI port, please try switching the HDMI EDID Version. (Refer to below)
- If headphones or Bluetooth audio devices are connected, sound is not output from the TV speakers or audio system connected via ARC. Remove the headphones or disconnect the Bluetooth audio device.

Picture poor, sound intermittent or no sound

View other TV channels. The problem might be limited to the broadcasting station or weak signal strength.

Use Headphone/Bluetooth devices and audio system/TV speakers at the same time.

To output sound from both the headphones/Bluetooth audio device and TV speakers

The TV cannot output sound from both the headphones or Bluetooth audio device and the TV speakers at the same time.

To output sound from both an audio system connected via ARC and TV speakers

Sound can be output from both an audio system connected to the TV and the TV speakers at the same time by satisfying the following conditions.

- Connecting the TV and audio system using a digital optical cable
- Setting [Digital Output] to [PCM]

How to connect Digital audio Optical

Use a digital audio optical cable to connect the unit to external digital audio devices.

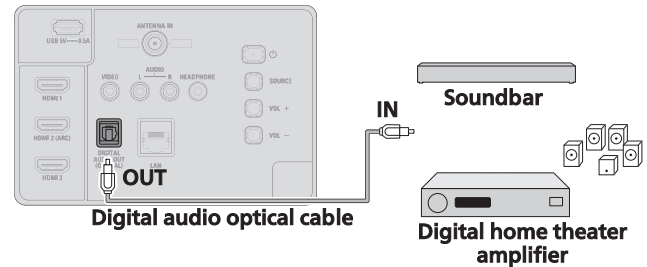

HDMI-ARC connection (Digital home theater amplifier that supports HDMI-ARC)

HDMI-ARC allows you to use HDMI control to output TV audio directly to a connected audio device, without the need for an additional digital audio cable.

HDMI-ARC is only available on HDMI-2, so connect your device to this HDMI-2 if sound output from the TV through HDMI is needed

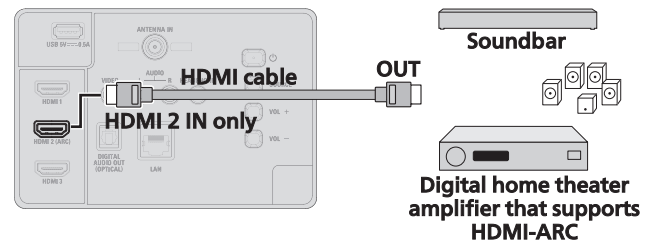

Pair a Bluetooth device

- 1 From the Google TV home screen, in the top right, go to the profile picture or initial and select **Settings**.
- 2 Select **Remote & Accessories > Pair accessory**
- 3 Make sure your device is in pairing mode or is visible to other devices.
- 4 Identify the device you want to pair from the list and select it.
- 5 On the Bluetooth pairing request screen, select **Pair**.

Note(s)

Accessories that have been paired with your device appear in the **Remote & Accessories** section of Settings. You can also rename or forget devices.

Cable/Satellite TV

I can not watch cable/satellite set-top box(STB) programs.

- Check that HDMI cable connection is secure on TV and connected device.
- Unplug and reconnect the cable to force a reconnection.
- If using 15 ft. or longer HDMI cable, try a shorter one.
- Try a different HDMI Input on the TV. Sometimes HDMI settings are set different.
- Verify that the connected device is outputting a resolution supported by your television
 - 640x480 (SD)
 - 1280x720 (HD)
 - 1920x1080 (FHD)
 - 3840x2160 (4K)
- If connected device is outputting 4K with HDR, change the TV HDMI settings to EDID 2.0
- If connected device is older and does not support 4K or HDR, change the TV HDMI settings to EDID 1.4

External devices

HDMI digital connection (normal connection)

HDMI connection offers the highest picture quality. HDMI (High-Definition Multimedia Interface) transports highdefinition digital video and multi-channel digital audio through a single cable.

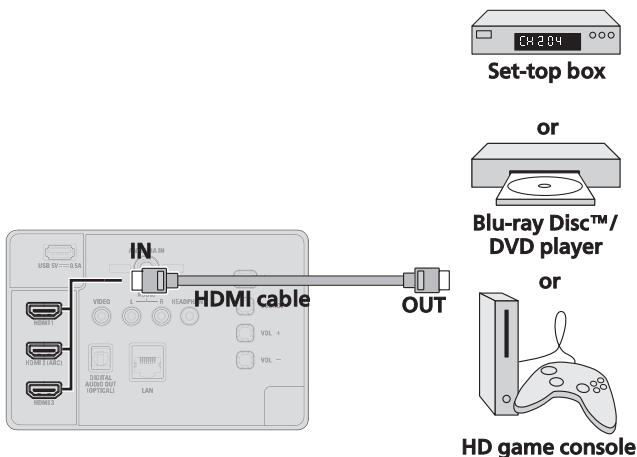

HDMI-ARC connection (Digital home theater amplifier that supports HDMI-ARC)

HDMI-ARC allows you to use HDMI control to output TV audio directly to a connected audio device, without the need for an additional digital audio cable.

HDMI-ARC is only available on HDMI-2, so connect your device to this HDMI-2 if sound output from the TV through HDMI is needed.

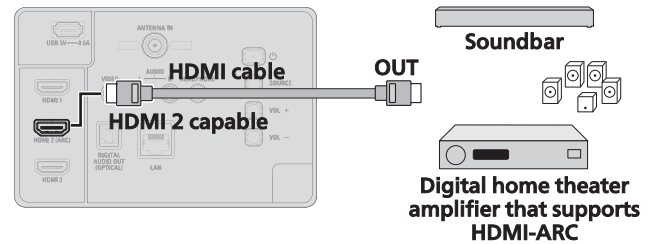

If connecting cable/satellite/IPTV set-top box using an HDMI cable

If the TV is connected to a cable/satellite set-top box via an HDMI cable, make sure you select the correct source by using **INPUT** on your remote control.

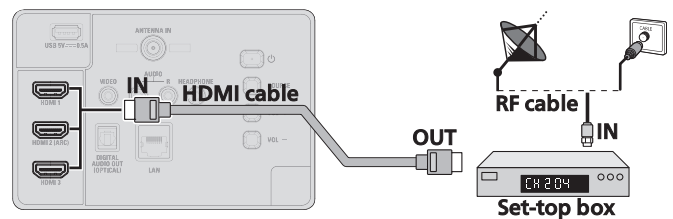

If connecting cable/satellite/IPTV set-top box using an RF cable

If the TV is connected to a cable/satellite set-top box via a coaxial connection, set the TV to channel 3/4 or the channel specified by the service provider.

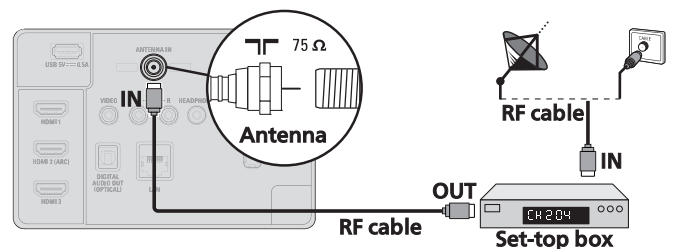

Connecting a cable/satellite/IPTV set-top box, Blu-ray Disc/DVD recorder via composite connectors and analog audio

Do not place your recorder too close to the screen because some recorders can be susceptible to harmful interference from the TV.

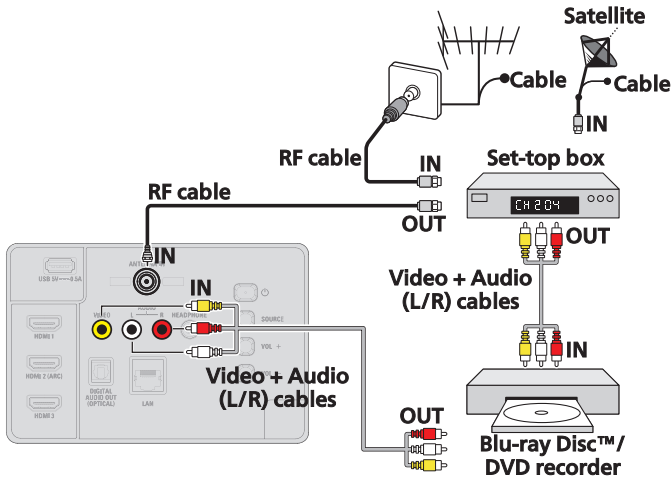

Composite analog video connection

Composite analog video connection offers standard picture quality for video devices connected to the unit.

If you connect to the unit's composite video (VIDEO) input jack, connect audio cables to the audio (L/R) input jacks. When the audio is monaural, then only connect to the audio L input jack.

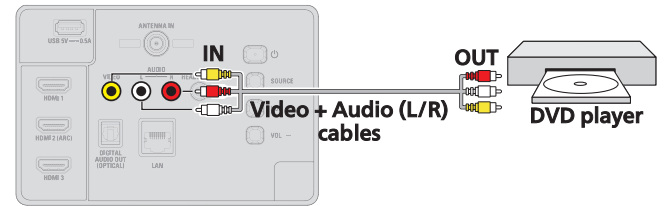

Connecting the TV to the internet using an Ethernet cable

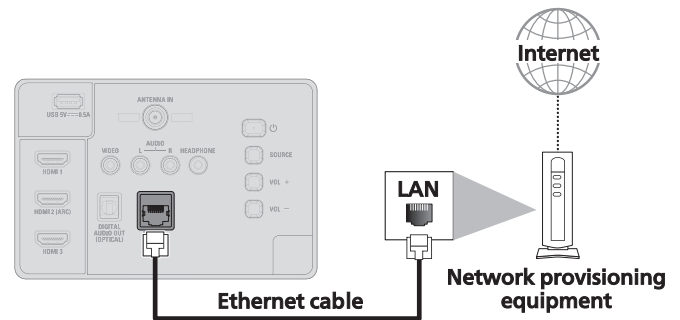

Digital audio output connection

If you connect this unit to an external digital audio device, you can enjoy multi-channel audio like 5.1ch digital broadcasting sound.

Use a digital audio optical cable to connect the unit to external digital audio devices.

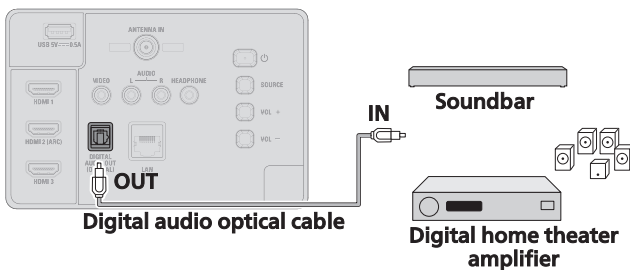

Check your Wi-Fi connection

- 1 From the Google TV home screen, in the top right, go to the profile icon and select **Settings**.
- 2 Select **Network & Internet**.
- 3 Confirm that **Wi-Fi** is turned on and you're connected to the correct network.
- 4 If not, locate the network you'd like to connect to and select it to connect. Enter the password if required.
- 5 Open one of your apps.
- 6 Play your video, music, or game again.

Note(s)

If you still have issues, turn the Wi-Fi option off and on again.

Headphone audio output

Headphone 3.5 mm stereo jack for personal listening.

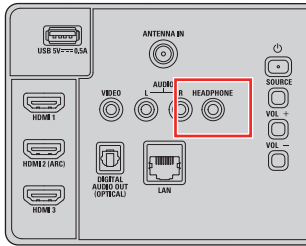

Reconnect a paired device

- 1 From the Google TV home screen, in the top right, go to the profile icon and select **Settings**.
- 2 Select **Remote & Accessories**.
- 3 Under "ACCESSORIES" choose your device.
- 4 Select **Connect**.

Fix problems with connecting Bluetooth devices

If your Bluetooth device won't connect, it could be an issue with the Bluetooth device or your TV.

Troubleshoot connection issues

- 1 Turn off your Bluetooth device and then turn it back on. After your device is reset, try to pair it again.
- 2 If you have multiple devices paired with your TV, disconnect the ones you're not using.
- 3 Unplug your TV for 10 seconds and then plug it back in. When your TV is on, try to pair it again.
- 4 Check if your Bluetooth device connects to other devices, such as a phone or tablet.
 - a. If your device connects to other devices: Reset your Google TV device to factory settings.
 - b. If your device doesn't connect to other devices: Check that your Bluetooth device has up-to-date software or get help from the device's manufacturer.

Pair a Bluetooth device

- 1 From the Google TV home screen, in the top right, go to the profile picture or initial and select **Settings**.
- 2 Select **Remote & Accessories > Pair accessory**
- 3 Make sure your device is in pairing mode or is visible to other devices.
- 4 Identify the device you want to pair from the list and select it.
- 5 On the Bluetooth pairing request screen, select **Pair**.

Note(s)

Accessories that have been paired with your device appear in the **Remote & Accessories** section of Settings. You can also rename or forget devices.

Connect Bluetooth

You can connect several Bluetooth devices, like headphones or game controllers, to your Google TV. You can only connect one audio device at a time.

Pair a Bluetooth device

- 1 From the Google TV home screen, in the top right, go to the profile picture or initial and select **Settings**.
- 2 Select **Remote & Accessories > Pair accessory**
- 3 Make sure your device is in pairing mode or is visible to other devices.
- 4 Identify the device you want to pair from the list and select it.
- 5 On the Bluetooth pairing request screen, select **Pair**.

Note(s)

Accessories that have been paired with your device appear in the **Remote & Accessories** section of Settings. You can also rename or forget devices.

7 Information

Glossary

Analog TV (NTSC)

Acronym that stands for National Television Systems Committee and the name of analog broadcasting standards. Off the air analog TV signals are no longer being sent by major broadcasting stations in the USA.

ARC (Audio Return Channel) (HDMI 2 only)

HDMI-ARC allows you to use Philips HDMI control to output TV audio directly to a connected audio device, without the need for an additional digital audio cable. Be sure that the device is HDMI CEC and ARC compliant, and that the TV is connected to the device using an HDMI cable attached to both HDMI-ARC connectors.

Aspect ratio

The width of a TV screen relative to its height. Conventional TVs are 4:3 (in other words, the TV screen is almost square); widescreen models are 16:9 (the TV screen is almost twice as wide as its height).

CEC (Consumer Electronics Control)

This allows you to operate the linked functions between our brand devices with CEC feature and this unit. We do not guarantee 100% interoperability with other brands of CEC compliant devices.

Dolby Digital

The system developed by Dolby Laboratories to compress digital sound. It offers stereo sound (2ch) or multi-channel audio.

DTV (ATSC)

Abbreviation that stands for Advanced Television Systems Committee and the name of the digital broadcasting standards.

e-POP

e-POP is showing set features, technical information, etc on this TV set that is displayed on the TV screen mainly used by TV retailers. Previously the information was on a printed sticker that was put on the display.

HDMI (High-Definition Multimedia Interface)

Interface that supports all uncompressed, digital audio/video formats including set-top box, Blu-ray Disc™/DVD recorder or digital television, over a single cable.

HDR10

High Dynamic Range (HDR10) is a new video technology, which lets you experience more detail and captivating colors for an even more engaging television experience. More perceivable shades of blacks, whites and all other colors.

UHD

4K/UHD means the TV's screen has a minimum resolution of 3,840 pixels wide and 2,160 pixels high, making it the equivalent to two 1080p screens in height and two in length. This resolution was originally known as "Quad HD," and it's used by basically every 4K TV.

PIN code

A stored 4-digit number that allows access to parental control features.

SAP (Secondary Audio Program)

Second-audio channel delivered separately from the Main-audio channel. This audio channel is used as an alternate in bilingual broadcasting.

Maintenance

Cleaning

- Clean the front panel and other exterior surfaces of the unit with a soft microfiber cloth or lens brush. Before cleaning the panel, disconnect the AC power cord.
- Never use a solvent or alcohol. Do not spray insecticide liquid near the unit. Such chemicals may cause damage and discoloration to the exposed surfaces.
- Do not spray any liquids on the screen or other exterior surfaces of this unit. If liquids enter the unit, they could cause shorts, electric shocks or fire damage.



Servicing

Should your unit become inoperative, do not try to correct the problem yourself. There are no user serviceable parts inside. Call our toll free customer support line found on the cover of this user manual to locate an authorized service center.

Specifications

Model #	75PUL7552/F7	65PUL7672/F7 65PUL7552/F7	55PUL7672/F7 55PUL7552/F7	50PUL7672/F7 50PUL7552/F7	43PUL7672/F7 43PUL7652/F7
Picture					
Type	UHD (Ultra HD) (3840 x 2160 pixels 60 Hz)				
Diagonal screen size/Aspect ratio	74.5"/16:9	64.5"/16:9	54.6"/16:9	49.5"/16:9	42.5"/16:9
Viewing angles	178° (V) by 178° (H)				
Built-in digital/analog tuner	ATSC (digital) / NTSC (analog)				
Sound					
Mono/Stereo	Mono, Stereo				
Power output (RMS watts)	10 W x 2			8 W x 2	
Equalizer	5 band				
Ease of use					
Screen	Automatic/Full/Unscaled/4:3/Movie expand				
Channel					
Channel coverage	Over-the-Air DTV (ATSC)	VHF: 2~13 UHF: 14~69 (Each channel may have e.g. 2.1~2.9, 3.1~3.9, etc)			
	Over-the-Air Analog (NTSC)	VHF: 2~13 UHF: 14~69			
CATV (Analog NTSC)	2~13, A~W W+1~W+94 (Analog W+1~W+84), A-5~A-1, 5A				
Tuning system	Channel frequency synthesized tuning system				
Channel access	Direct access number keyboard, Programmable scan and Channel + (up)/- (down)				
Connectivity					
Composite video input	1				
HDMI input	3 (selectable HDMI modes)				
	Supporting HDMI video signals: 480i/p, 720p, 1080i @60 Hz, 1080p, 2160p @24/30/60 Hz				
	Supporting HDMI HDR signals: HDR10, HLG (Hybrid Log-Gamma)				
	Supporting HDMI digital audio signals: LPCM, AC3, DD+ Supporting PC-input video signal up to 4096 x 2160				
Analog audio L/R input	1 (L Audio/R Audio)				
PC input	HDMI				
USB	1				
Wireless LAN	Wireless LAN Supporting wireless standards: IEEE 802.11a/b/g/n/ac (2.4 GHz/5 GHz)				
Ethernet port	1				
Digital audio output	1 Supporting Dolby Audio				
Headphone output	1 1/8" (3.5 mm)				
Bluetooth	Version 5.1				
Power					
Power requirements	120 V~ +/- 10 %, 60 Hz +/- 0.5 %				
Temperature					
Operating temperature	41 °F (5 °C) to 104 °F (40 °C)				

- Specifications are subject to change without prior notice.

Warranty

Limited warranty one (1) year

Warranty coverage:

This warranty obligation is limited to the terms as set forth below.

Who is covered:

This product warranty is issued to the original purchaser or the person receiving the product as a gift against defects in materials and workmanship as based on the date of original purchase ("Warranty Period") from an Authorized Dealer. The original sales receipt showing the product name and the purchase date from an authorized retailer is considered such proof.

What is covered:

This warranty covers new products if a defect in material or workmanship occurs and a valid claim is received within the Warranty Period. At its option, the company will either (1) repair the product at no charge, using new or refurbished replacement parts, or (2) exchange the product with a product that is new or which has been manufactured from new, or serviceable used parts and is at least functionally equivalent or most comparable to the original product in current inventory, or (3) refund the original purchase price of the product.

Replacement products or parts provided under this warranty are covered against defects in materials and workmanship from the date of the replacement or repair for ninety (90) days or for the remaining portion of the original product's warranty, whichever provides longer coverage for you. When a product or part is exchanged, any replacement item becomes your property and the replaced item becomes company property. When a refund is given, your product becomes company property.

Note: Any product sold and identified as refurbished or renewed carries a ninety (90) day limited warranty.

Replacement product can only be sent if all warranty requirements are met. Failure to follow all requirements can result in delay.

What is not covered - Exclusions and limitations:

This Limited Warranty applies only to new company manufactured products that can be identified by the trademark, trade name, or logo affixed to it. This Limited Warranty does not apply to any hardware product or any software, even if packaged or sold with the product, as manufacturers, suppliers, or publishers may provide a separate warranty for their own products packaged with the bundled product.

The company is not liable for any damage to or loss of any programs, data, or other information stored on any media contained within the product, or other additional product or part not covered by this warranty. Recovery or reinstallation of programs, data or other information is not covered under this Limited Warranty.

This warranty does not apply (a) to damage caused by accident, abuse, misuse, neglect, misapplication, or non-supplied product, (b) to damage caused by service performed by anyone other than company approved Authorized Service Location, (c) to a product or a part that has been modified without written company permission, or (d) if any serial number has been removed or defaced, or (e) product, accessories or consumables sold "AS IS" without warranty of any kind by including refurbished product sold "AS IS" by some retailers.

This Limited Warranty does not cover:

This warranty gives you specific legal rights. You may have other rights which vary from state/province to state/province.

- Shipping charges to return defective product.
- Labor charges for installation or setup of the product, adjustment of customer controls on the product, and installation or repair of antenna/signal source systems outside of the product.
- Product repair and/or part replacement because of improper installation or maintenance, connections to improper voltage supply, power line surge, lightning damage, retained images or screen markings resulting from viewing fixed stationary content for extended periods, product cosmetic appearance items due to normal wear and tear, unauthorized repair or other cause not within the control of the company.
- Damage or claims for products not being available for use, or for lost data or lost software.
- Damage from mishandled shipments or transit accidents when returning product.
- A product that requires modification or adaptation to enable it to operate in any country other than the country for which it was designed, manufactured, approved and/or authorized, or repair of products damaged by these modifications.
- A product used for commercial or institutional purposes (including but not limited to rental purposes).
- Product lost in shipment and no signature verification receipt can be provided.
- Failure to operate per user manual.

To obtain assistance...

Contact the Customer Care Center at:

1 833 978 3323

Chat with us in English:

<https://tinyurl.com/y2e29xsq>

REPAIR OR REPLACEMENT AS PROVIDED UNDER THIS WARRANTY IS THE EXCLUSIVE REMEDY FOR THE CONSUMER, WITH THE ISSUING COMPANY NOT LIABLE FOR ANY INCIDENTAL OR CONSEQUENTIAL DAMAGES FOR BREACH OF ANY EXPRESS OR IMPLIED WARRANTY ON THIS PRODUCT. EXCEPT TO THE EXTENT PROHIBITED BY APPLICABLE LAW, ANY IMPLIED WARRANTY OF MERCHANTABILITY OR FITNESS FOR A PARTICULAR PURPOSE ON THIS PRODUCT IS LIMITED IN DURATION TO THE DURATION OF THIS WARRANTY.

Some states do not allow the exclusions or limitation of incidental or consequential damages, or allow limitations on how long an implied warranty lasts, so the above limitations or exclusions may not apply to you.

Funai Service Corporation, 2425 Spiegel Drive, Groveport, OH 43125, USA

License

Funai Corporation, Inc. hereby offers to deliver, upon request, a copy of the complete corresponding source code for the copyrighted open source code packages, on an "AS IS" basis, used in this product for which such offer is requested by the respective licenses. This offer is valid up to three years after the product purchase to anyone in receipt of this information. To obtain source code, please contact Funai Corporation, Inc. You should write to Funai Service Corporation OSS Request, 2425 Spiegel Drive, Groveport, OH 43125, USA. Funai Corporation, Inc. disclaims any and all warranties and representations with respect to such software and related source code including quality, reliability, usability, and accuracy, and further disclaim all express, implied, statutory or otherwise, including without limitation, any implied warranties of title, non-infringement, merchantability, or fitness for a particular purpose. Funai Corporation, Inc. shall not be liable to make any corrections to the open source software or source code or to provide any support or assistance with respect to it. Funai Corporation, Inc. disclaims any and all liability arising out of or in connection with the use of this software and/or source code.



Funai Corporation, Inc.
12489 Lakeland Road, Santa Fe Springs, CA 90670, USA

This product has been manufactured by and is sold under the responsibility of Funai Corporation, Inc., and Funai Corporation, Inc. is the warrantor in relation to this product.

Philips and the Philips Shield Emblem are registered trademarks of Koninklijke Philips N.V. and are used under license.

ADL90UB-75UB/AD79LUB-75UB/AF781UT-65UB/ADL84UA-65UB/
ADL83UA-65UB/ADL82UA-65UB/ADL81UA-65UB/ADL80UA-65UB/
AF7R1UT-55UB/ADLR0UT-55UB/AF7U1UT-50UX/ADLU1UT-50UB/
ADLU0UT-50UX/AF7V1U2-43UB/AF7V0U2-43UB
★★★★★

