

Safety Instructions & Operator's Manual for
SNAPPER[®]

**19" STEEL DECK
WALK MOWERS
SERIES 14**



MODELS
R194014

MODEL NUMBER EXPLANATION			
R	19	40	14
MODEL DESIGNATION	CUTTING WIDTH		SERIES DESIGNATION ENGINE HORSE POWER
R – Recycling Model	19 – 19" Cutting Width		14 Series Designation 40 – 4.0 HP (Engine Horse Power)

Thank you for buying a SNAPPER Product! Before operating your Walk Behind, read this manual carefully and pay particular attention to the "IMPORTANT SAFETY INSTRUCTIONS" on Pages 2 & 3. Remember that all power equipment can be dangerous if used improperly. Also keep in mind that SAFETY requires careful use in accordance with the operating instructions and common sense.

SNAPPER McDonough, GA., 30253 U.S.A.



IMPORTANT SAFETY INSTRUCTIONS

WARNING: This powerful cutting machine is capable of amputating hands and feet and can throw objects that can cause injury and damage! Failure to comply with the following **SAFETY** instructions could result in serious injury or death to the operator or other persons. The owner of the machine must understand these instructions and must allow only persons who understand these instructions to operate machine. Each person operating the machine must be of sound mind and body and must not be under the influence of any substance, which might impair vision, dexterity or judgment. If you have any questions pertaining to your machine which your dealer cannot answer to your satisfaction, call or write the Customer Service Department at SNAPPER, McDonough, Georgia 30253. Phone: (1-800-935-2967).

PROTECTION FOR CHILDREN

Tragic accidents can occur if the operator is not alert to the presence of children. Children are often attracted to the machine and the mowing activity. Never assume that children will remain where you last saw them.

1. **KEEP** children out of the mowing area and under the watchful care of a responsible adult.
2. **DO NOT** allow children in yard when machine is operated and turn machine **OFF** if anyone enters the area.
3. **DO NOT** allow pre-teenage children to operate machine.
4. **ALLOW** only responsible adults & teenagers with mature judgment under close adult supervision to operate machine.
5. **DO NOT** pull mower backwards unless absolutely necessary. **LOOK BEHIND** and down for small children before and when backing.
6. **USE EXTRA CARE** when approaching blind corners, shrubs, trees, or other objects that may obscure vision.

SLOPE OPERATION

1. Slopes are a major factor related to slip and fall accidents which can result in severe injury. All slopes require extra caution. If you feel uneasy on a slope, do not mow it.
2. Mow across slopes, never up-and-down. Exercise extreme **CAUTION** when changing directions on slopes. **DO NOT** mow steep slopes or other areas where stability or traction is in doubt.

PREPARATION

1. Read, understand, and follow instructions and warnings in this manual and on the mower and with attachments. Know the controls and the proper use of the mower before starting.
2. Only mature, responsible persons shall operate the machine and only after proper instruction.
3. Handle fuel with extra care. Fuels are flammable and vapors are explosive. Use only an approved fuel container. Never remove fuel cap or add fuel with engine running. Add fuel outdoors only with engine stopped and cool. Clean spilled fuel and

oil from machine. **DO NOT** smoke. **DO NOT** run engine indoors.

PREPARATION

4. Check the area to be mowed and remove all objects such as toys, wire, rocks, limbs and other objects that could cause injury if thrown by blade or interfere with mowing. Also note the location of holes, stumps, and other possible hazards.
5. Keep people and pets a safe distance from machine.
6. Check shields, deflectors, switches, blade controls and other safety devices frequently for proper operation and location.
7. Make sure all safety decals are clearly legible. Replace if damaged.
8. Protect yourself when mowing and wear safety glasses, long pants and substantial footwear. **DO NOT** mow barefooted or with sandals.
9. Know how to **STOP** blade and engine quickly in preparation for emergencies.
10. Use extra care when loading or unloading the machine into a trailer or truck.

OPERATION

1. **DO NOT** put hands or feet near or under rotating parts. Keep clear of discharge area while engine is running.
2. **STOP** engine when crossing gravel drives, walks, or roads, and under any conditions where thrown objects might be a hazard.
3. Mow only in daylight or good artificial light.
4. **DO NOT** operate mower while under the influence of alcohol or drugs.
5. After striking a foreign object or if mower vibrates abnormally, **STOP** the engine, disconnect and secure spark plug wire. Inspect the mower for any damage and repair the damage.
6. Watch for holes, ruts or bumps. Tall grass can hide obstacles.
7. **DO NOT** mow near drop offs, ditches or embankments. Operator could lose footing or balance.
8. **DO NOT** mow on wet grass Always be sure of your footing; keep a firm hold on the handle and walk; never run. Slipping could cause injury.

IMPORTANT SAFETY INSTRUCTIONS

OPERATION

9. **STOP** blade and engine whenever you leave the operating position behind the handle for any reason, including clearing grass, emptying grass bag and making wheel height adjustments, repairs, or inspections.
10. Before cleaning, repairing or inspecting make certain blade and all moving parts have **STOPPED**. Disconnect and secure spark plug wire away from plug to prevent accidental starting.
11. **STOP** engine and wait until the blade comes to complete **STOP** before removing grass bag and/or clearing grass.

MAINTENANCE AND STORAGE

1. Never store machine or fuel container inside where fumes may reach an open flame, spark or pilot light such as in a water heater, furnace, clothes dryer or other gas appliance. Allow engine to cool before storing machine in an enclosure. Store fuel container out of reach of children in a well ventilated, unoccupied building.
2. Keep mower and engine free of grass, leaves or excess grease to reduce fire hazard and engine overheating.
3. When draining fuel tank, drain fuel into an approved container outdoors and away from open flame.

MAINTENANCE AND STORAGE

4. Keep all bolts, especially blade bolts, nuts and screws properly tight. Check that all cotter pins are in proper position.
5. Service engine and make adjustments only when engine is stopped. Removed spark plug wire from spark plug and secure wire away from spark plug to prevent accidental starting.
6. **DO NOT** change engine governor speed settings or overspeed engine.
7. Check grass bag assembly frequently for wear or deterioration to avoid thrown objects and exposure to moving parts. Replace with new bag if loose seams or tears are evident. Replace slider or bag adapter if broken or cracked.
8. Mower blades are sharp and can cut. Wrap the blades or wear heavy leather gloves and use **CAUTION** when handling them.
9. **NEVER** test for spark by grounding spark plug next to spark plug hole; spark plug could ignite gas exiting engine.
10. Have machine serviced by an authorized **SNAPPER** dealer at least once a year and have the dealer install any new safety devices.
11. Use only genuine **SNAPPER** replacement parts to assure that original standards are maintained.

TABLE OF CONTENTS

IMPORTANT SAFETY INSTRUCTIONS.....	2-3
TABLE OF CONTENTS	4
SECTION 1 - FAMILIARIZATION.....	5
SECTION 2 - OPERATING INSTRUCTIONS.....	6-8
Pre-start Checklist.....	6
Starting & Stopping Engine & Blades	6-7
Adjusting Handle Height.....	7
Adjusting Cutting Height	8
Recycling Operation.....	8
Recycling Cover Installation/Removal	8
SECTION 3 - MAINTENANCE INSTRUCTIONS.....	9-10
Changing Engine Oil	9
Checking Mower Blade	9
Annually (End of Each Season)	10
Engine.....	10
Air Filter	10
Engine Oil.....	10
Storage Procedure	10
SECTION 4 - ADJUSTMENTS AND REPAIR.....	11
Mower Blade Replacement.....	11
Mower Blade Sharpening	11
TROUBLESHOOTING	12
SERVICE SCHEDULE	13
Maintenance/Replacement Parts	13
WARRANTY	14
PRIMARY MAINTENANCE	15-18

Section 1 - FAMILIARIZATION

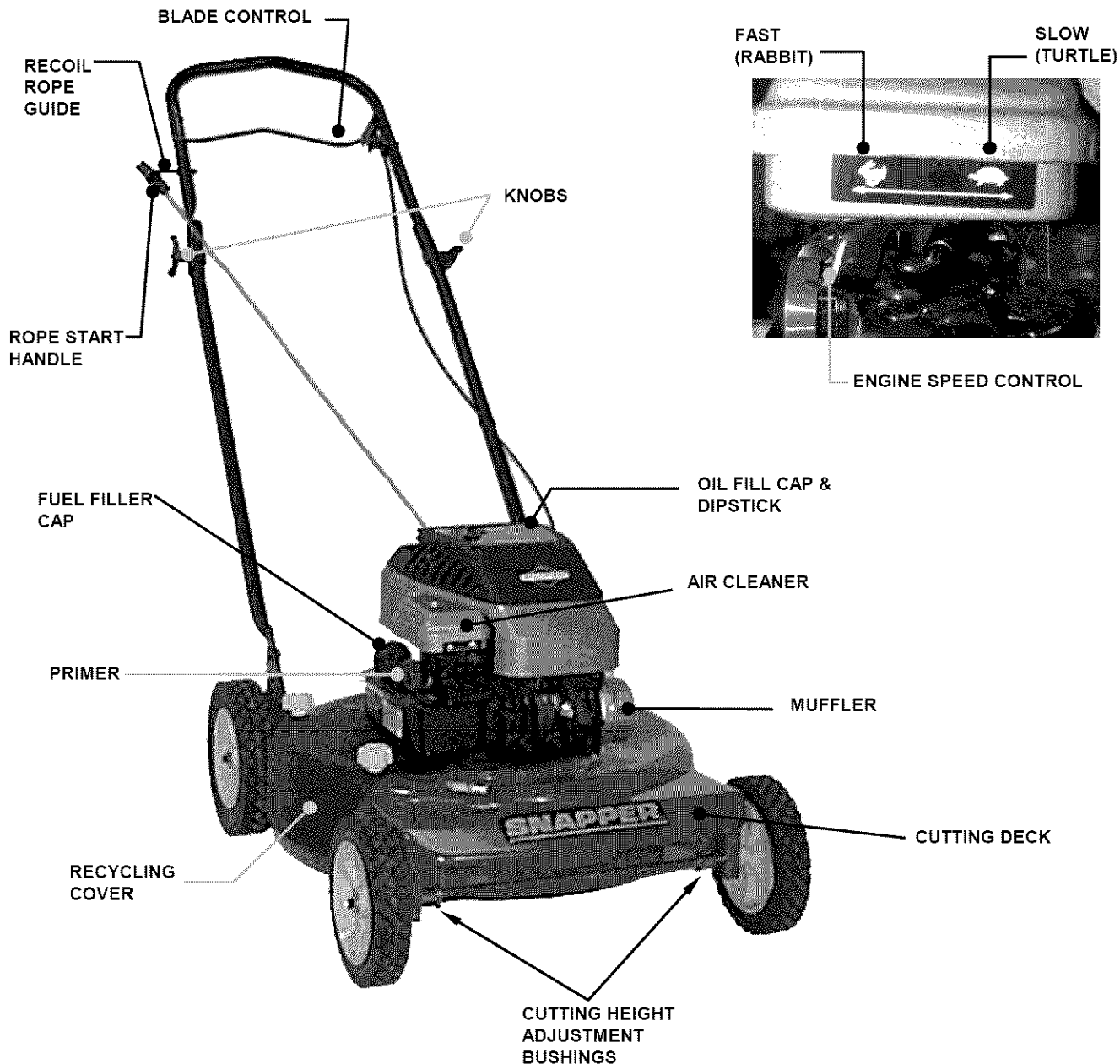

FIGURE 1.1

1.1 INTRODUCTION

This manual has been prepared for the operators of the SNAPPER WALK BEHIND MOWERS. Its purpose, aside from recommending operating and routine service requirements, is to promote safety through the use of accepted operating practices. **Read, Understand and Follow** the "IMPORTANT SAFETY INSTRUCTIONS" on Pages 2 & 3 of this manual and all safety messages on the mower and attachments before operating the mower.

1.2 NOMENCLATURE

The nomenclature information above, Figure 1.1, shows the essential parts of the SNAPPER WALK BEHIND MOWERS. It is recommended that all operators of the mower become thoroughly familiar with the controls, parts and operation of the mower before operating. Specific details involving the engine are found in the separate engine owner's manual. Study these manuals before operating and keep both handy for future reference.

Section 2 - OPERATING INSTRUCTIONS

2.1 PRE-START CHECK LIST

Make the following checks and perform the service required before each start-up.

2.1.1. Check guards, deflectors, grass bag, adapter and covers to make sure all are in place and securely tightened.

2.1.2. Check blade control to insure it works freely. See Figure 2.1.

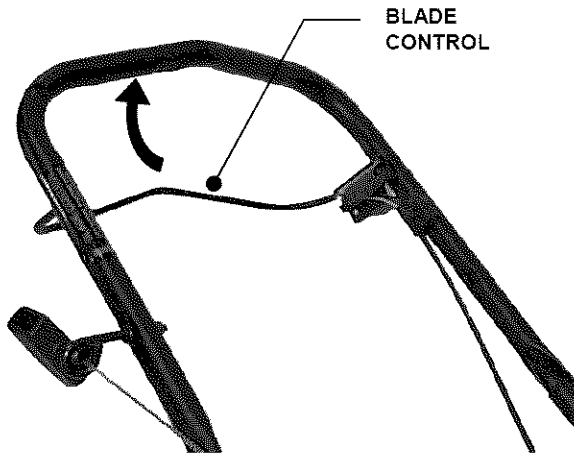

FIGURE 2.1

2.1.3. Check cutting height. Adjust to desired height.

2.1.4. Check engine oil and add oil as needed to bring level up to the full mark. Refer to Engine Owner's Manual for oil specifications. See Figure 2.2.



FIGURE 2.2

2.1.5. Add fuel to tank after pushing the mower outside where fumes can safely dissipate. Make sure cap is tightened after refueling. Refer to Engine Owners Manual for specifications.

2.1.6. Clean exterior surfaces of cutting deck and engine of any accumulation of spilled fuel, dirt, grass, oil, etc. Keep engine air intake screen and cooling fins clear at all times.

2.2 STARTING & OPERATION

2.2.1. ENGINE & BLADE (Recoil Start)

The engine speed control is located on the front of the engine, adjacent to the primer button. Move the engine speed control to fast (rabbit) position prior to starting engine. For optimum mowing performance, always operate mower with the engine speed set at the fast (rabbit) position.

1. Push primer button three times to start a cold engine. **NOTE:** Do not use primer button to start warm engine. See Figure 2.3.

IMPORTANT: Stop the engine (and blade) by releasing the blade control.

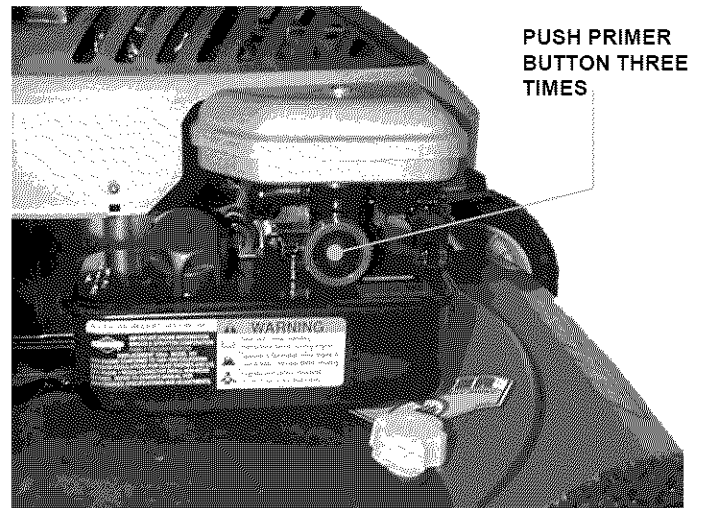

FIGURE 2.3

2. Pull blade control against handle.
3. Pull rope start handle to crank engine.
4. After engine starts, allow a brief warm-up until engine runs smooth.

Section 2 - OPERATING INSTRUCTIONS

2.3 STOPPING

Stop engine and blade by releasing the blade control. See Figure 2.6.

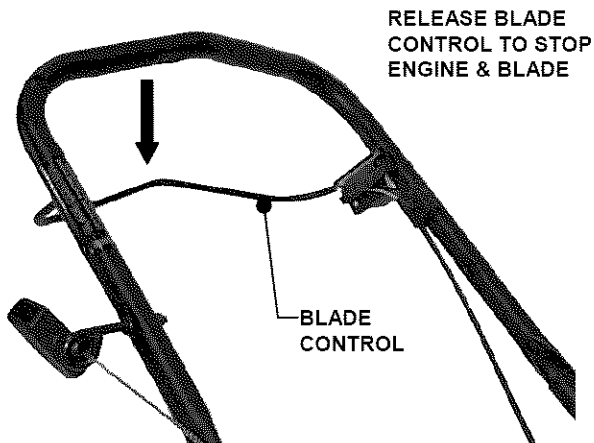

FIGURE 2.6

LOOSEN NUTS TO
ADJUST HANDLE
HEIGHT

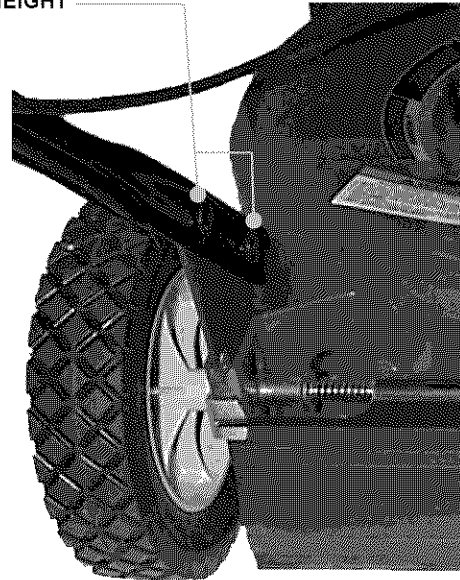

FIGURE 2.7



WARNING



DO NOT attempt any adjustments, maintenance or service with the engine or blade running. **STOP** blade. **STOP** engine. Remove spark plug wire from spark plug and secure wire away from spark plug. Engine and components can be extremely hot. Avoid burns by allowing engine and components sufficient time to cool. Wear heavy leather gloves when handling or working around cutting blades. Blades are extremely sharp and can cause severe injury.

2.4 HANDLE HEIGHT ADJUSTMENT

The height of the mower handle can be adjusted as follows:

1. Loosen the two nuts on the inside of each of the lower handles as shown in Figure 2.7.
2. Move the handle up or down to the desired height.
3. Retighten all nuts securely after adjustment.

Section 2 - OPERATING INSTRUCTIONS

WARNING

DO NOT attempt any adjustments, maintenance or service with the engine or blade running. STOP blade. STOP engine. Remove spark plug wire from spark plug and secure wire away from spark plug. Engine and components can be extremely hot. Avoid burns by allowing engine and components sufficient time to cool. Wear heavy leather gloves when handling or working around cutting blades. Blades are extremely sharp and can cause severe injury.

2.5 CUTTING HEIGHT ADJUSTMENT

1. FRONT WHEELS: Reposition the front axle by raising the front wheels off the ground, then pull in the spring loaded bushings until they clear the brackets. Move bushings to the desired height of cut position and release the bushings. See Figure 2.8.

2. REAR WHEELS: Reposition the rear axle by raising the rear wheels off the ground, then pull in the spring loaded bushings until they clear the brackets. Move bushings to the desired height of cut position and release the bushings. Position the rear bushings in to the same notches corresponding with notches for the front wheels to maintain the level of the deck. See Figure 2.8.

NOTE: There are four cutting height adjustment notches on each wheel. The top notch is the lowest cutting height and the lowest notch is the highest.

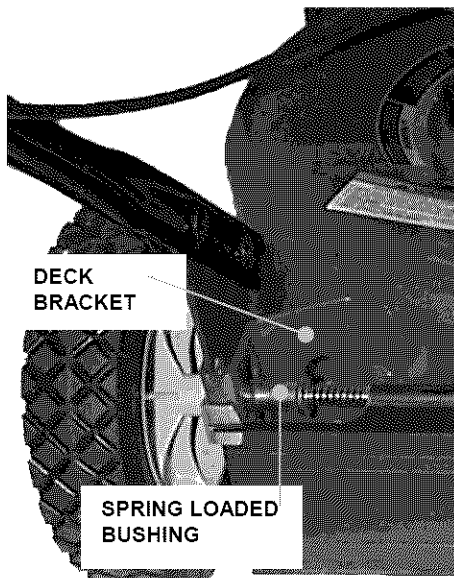

FIGURE 2.8

2.6 RECYCLING OPERATION

NOTE: For best recycling results, cut up to a maximum of 1/3 of grass blade length and recycle ONLY when grass is dry.

1. Set all wheels in the highest cutting position (Notch 4).
2. Proceed mowing slowly. If grass is very dense, lower each rear wheel latch one notch lower than the front wheel latches to improve recycling performance.

2.7 RECYCLING COVER (REMOVAL/INSTALLATION)

1. REMOVAL: The recycling cover is secured in place with two knobs. To remove the cover, unscrew the two knobs and lift off the cover. See Figure 2.9.

2. INSTALLATION: When reinstalling the cover, the deck sidewall should fit between the tab and outside of cover. Tighten knobs securely. See Figure 2.10.

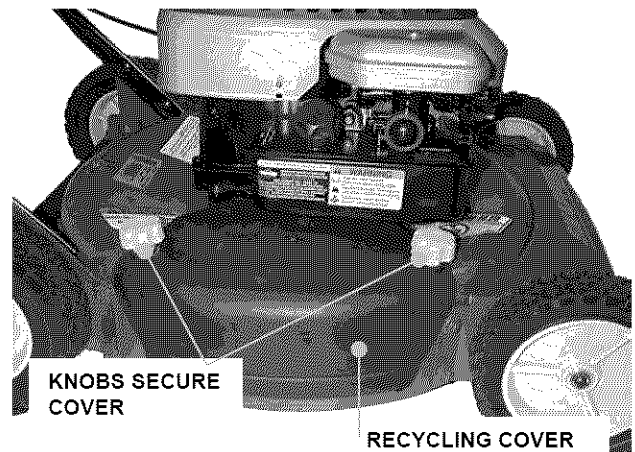
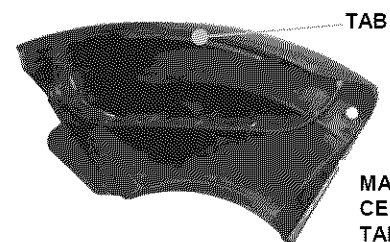
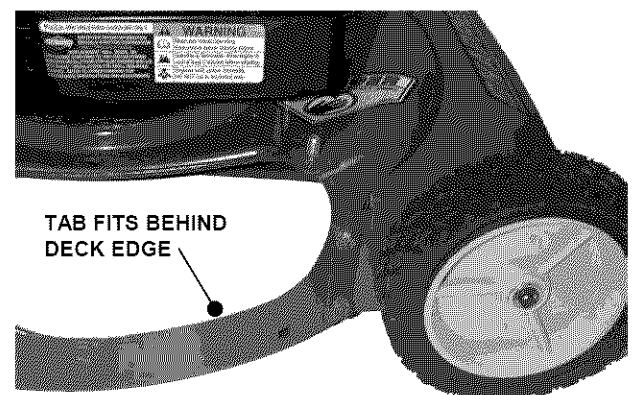

FIGURE 2.9



MAKE CERTAIN TAB FITS TO INSIDE OF DECK

FIGURE 2.10

Section 3 - MAINTENANCE

3.1 INTRODUCTION

To retain the quality of the mower, use genuine SNAPPER replacement parts only. Contact a local SNAPPER dealer for parts and service assistance. For the correct part or information for a particular mower, always mention model and serial number.

3.2 SERVICE - AFTER FIRST 5 HOURS

3.2.1. CHANGE ENGINE OIL

⚠ WARNING ⚠

DO NOT attempt any adjustments, maintenance or service with the engine or blade running. STOP blade. STOP engine. Remove spark plug wire from spark plug and secure wire away from spark plug. Engine and components can be extremely hot. Avoid burns by allowing engine and components sufficient time to cool. Wear heavy leather gloves when handling or working around cutting blades. Blades are extremely sharp and can cause severe injury.

1. Disconnect spark plug wire and secure end away from plug. The items needed to perform oil change are: cloth rags, (1) 3/8" drive ratchet with a short extension and (1) shallow pan.
2. Tilt mower up on its rear wheels for access to the oil drain plug located underneath the mower deck. Do not tilt mower with spark plug or carburetor down. See Figure 3.1.

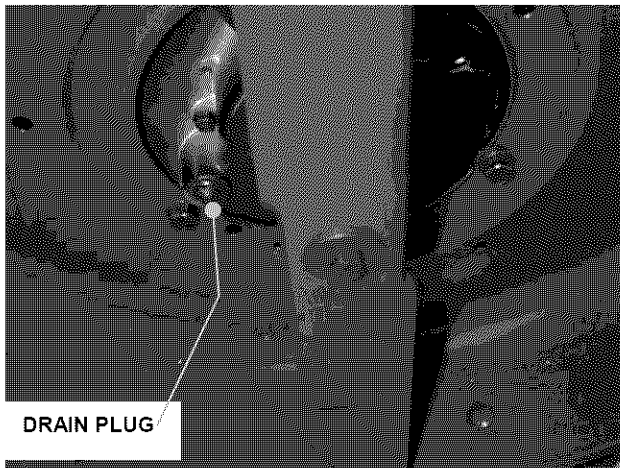

FIGURE 3.1

3. Place shallow pan underneath the approximate center of the oil drain plug.
4. Loosen with ratchet and short extension, but do not remove oil drain plug. Loosen plug until you can turn it with your fingers.

5. Lower the mower down and place the piece of wood under left rear wheel. Reach under mower and remove drain plug and allow oil to drain out completely in pan. Some oil may spill onto hands, immediately wipe hands clean with cloth rags.
6. Tilt mower back up and replace drain plug. Tighten securely but do not over tighten.
7. Fill engine with oil as specified in Engine Owner's Manual. Thereafter, change oil after each 25 hours of use.
8. Check air cleaner and perform air filter maintenance as specified in the Engine Owner's Manual.

IMPORTANT: DO NOT tip machine with carburetor or spark plug down, oil from crank case will saturate the air filter and cause the engine to be hard to start or not start at all. If contamination does occur, the air filter will have to be replaced.

3.2.2 CHECK MOWER BLADE

1. Disconnect spark plug wire and secure end away from plug.
2. Tilt mower up on its rear wheels for access to the blade cap screw. Do not tilt mower with spark plug or carburetor down. See Figure 3.2.
3. Check torque of blade retaining cap screw. Recommended torque should be 30 to 40 ft. lbs. See Figure 3.2.
4. Check blade for sharpness, wear and damage. See Section on Blade Wear Limits.

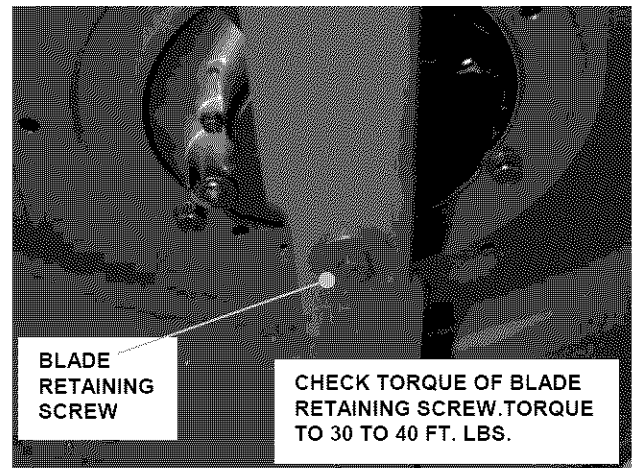

FIGURE 3.2

⚠ WARNING ⚠

To avoid spilling fuel, empty engine gas tank before tilting mower.

Section 3 - MAINTENANCE

3.3 ANNUALLY (END OF EACH SEASON)

Perform all maintenance as described in the maintenance schedule.

3.3.1. Engine

Service engine according to engine owner's manual.

3.3.2. Air Filter

Refer to engine owner's manual for service instructions.

3.3.3. Engine Oil

Refer to engine owner's manual for service instructions.

3.4 STORAGE PROCEDURE

Refer to the Engine Owner's Manual for directions regarding engine storage preparations. Prepare the mower for "end of season" storage as follows:

1. Drain fuel from fuel tank and let engine run until all fuel is out of the carburetor.
2. **Disconnect and remove the spark plug wire away from spark plug before any other preparations are made!**
3. Tape all openings closed to prevent spraying water into exhaust or air intakes during washing.
4. Tilt mower up on its rear wheels and thoroughly clean the underside of the deck. Do not tilt mower with spark plug or carburetor down. Scrape away any accumulation of grass with a putty knife and or wire brush.
5. Lubricate all exposed metal with a light coating of oil to prevent corrosion.
6. Loosen handle knobs. Carefully fold the handles forward, "flexing" the control cables to prevent cable damage.
7. Store the mower in a shed or other dry area, protected from weather.

Section 4 - ADJUSTMENTS & REPAIR

WARNING

DO NOT attempt any adjustments, maintenance or service with the engine or blade running. STOP blade. STOP engine. Remove spark plug wire from spark plug and secure wire away from spark plug. Engine and components can be extremely hot. Avoid burns by allowing engine and components sufficient time to cool. Wear heavy leather gloves when handling or working around cutting blades. Blades are extremely sharp and can cause severe injury.

4.1 MOWER BLADE REPLACEMENT

4.1.1. STANDARD BLADE WEAR LIMIT

1. Inspect blade frequently for signs of excessive wear or damage. See Figure 4.1.

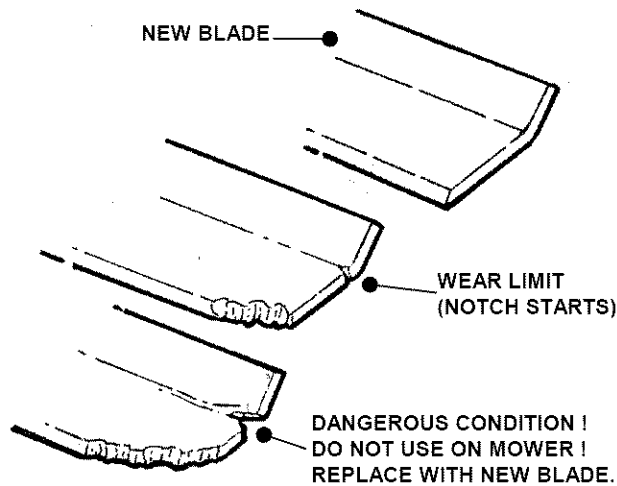

FIGURE 4.1

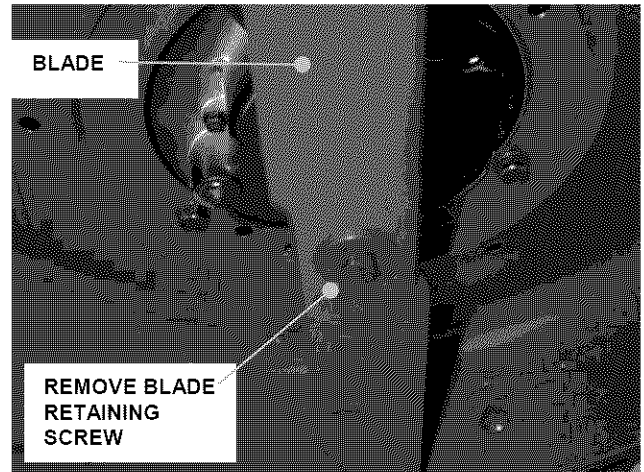

FIGURE 4.2

4. Sharpen blade on a grinding wheel at an angle of 22 to 28 degrees. DO NOT sharpen blade beyond original cutting edge. See Figure 4.3.

NOTE: DO NOT SHARPEN BEYOND ORIGINAL CUTTING EDGE.

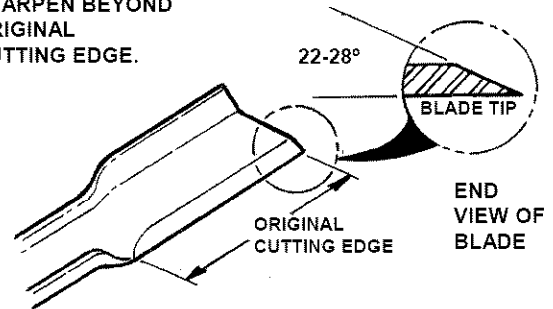

FIGURE 4.3

5. Check blade for balance. If necessary, correct balance by grinding heavy end of blade.
6. Reinstall blade. Refer to Figure 3.2. Check torque of blade retaining cap screw. Recommended torque should be 30 to 40 ft. lbs.

WARNING

Never use a cutting blade that shows signs of excessive wear or damage. Refer to Section on MOWER BLADE REPAIR/REPLACEMENT for proper blade inspection and service procedures.

4.1.2. BLADE SHARPENING

1. Disconnect spark plug wire and secure end away from plug.

IMPORTANT: DO NOT tip machine with carburetor or spark plug down, oil from crankcase will saturate the air filter and cause the engine to be hard to start or not start at all. If contamination does occur, the air filter will have to be replaced.

2. Tilt mower up on its rear wheels.
3. Remove blade. See Figure 4.2.

TROUBLESHOOTING

PROBLEM	PROBABLE CAUSE	CORRECTIVE ACTION
Engine Will Not Start Using Recoil Starter	1. Fuel tank empty.	1. Fill fuel tank with fresh fuel.
	2. Engine needs priming.	2. Push primer three times.
	3. Spark plug wire disconnected.	3. Place spark plug wire onto spark plug.
	4. Spark plug faulty.	4. Replace with new spark plug.
Engine Stalls or Stops After Running	1. Blade control is released or is not being held securely against handle.	1. Blade control should be held securely against handle at all times during operation of mower.
	2. Fuel tank empty.	2. Fill with fuel to proper level.
	3. Engine air pre-cleaner and or air cleaner dirty.	3. Clean free of all debris.
	4. Spark plug defective or gap set improperly.	4. Service spark plug.
	5. Water, debris or stale fuel in fuel system.	5. Drain and clean fuel system.
Engine Loses Power	1. Engine air pre-cleaner or air cleaner dirty	1. Clean or replace filters.
	2. Spark plug faulty.	2. Service spark plug.
	3. Water, debris or stale fuel in fuel system.	3. Drain and clean fuel system.
Excessive Vibration	1. Damaged, out of balance or bent mower blade.	1. Service mower blade.
	2. Loose blade components.	2. Service and tighten loose parts.
	3. Loose or missing air lift (if equipped).	3. Replace air lifts. Tighten to proper torque.
Cutting Grass Improperly	1. Cutting height too low or high.	1. Adjust cutting height.
	2. Engine speed too slow.	2. Contact authorized SNAPPER Dealer.
	3. Forward ground speed too fast.	3. Walk at slower pace.
	4. Terraced cut, side to side.	4. Adjust height of cut with height adjust bushings.
	5. Excessive deck pitch, front to rear.	5. Adjust height of cut with height adjust bushings.
	6. Cutting blade dull or damaged.	6. Sharpen cutting edges or replace blade.
Poor Grass Discharge	1. Engine speed too slow.	1. Contact authorized SNAPPER Dealer.
	2. Grass is wet.	2. Mow when grass is dry.
	3. Excessively worn or damaged blade.	3. Service mower blade.
	4. Build up of grass clippings and debris under deck.	4. Clean deck.
	5. Improper blade installed on deck.	5. Install proper SNAPPER blade.
	6. Blade installed improperly on deck.	6. Install blade properly.
Oil Leaking	1. Leaking engine case.	1. Contact authorized SNAPPER dealer.
		2. Check and tighten drain plug.
		3. Make sure dipstick or oil filler cap is securely in place.



SERVICE SCHEDULE

ITEM	SERVICE PERFORMED	REF.	EACH USE	5 HRS	25 HRS	50 HRS	100 HRS	EACH SEASON
Engine Oil	Check Oil Level	Page 6	X					
	Initial Oil Change	Page 9		X				
	Periodic Oil Change	Page 9			X*			
Air Pre-Cleaner	Clean Sponge Element	Engine Manual & Page 10.			X**			
Air Cleaner	Clean or Replace	Engine Manual.			X**			
Spark Plug	Replace	Engine Manual.					X	
Mower Blade	Check For Wear, Damage & Replacement	Page 9-11	X					
Mower Deck	Clean Debris Accumulation	Page 10	X					

* Change oil every 25 hours when operating under heavy load or high temperatures.

**Clean more often under dusty conditions or when air debris is present

4.2. MAINTENANCE/REPLACEMENT PARTS

MAINTENANCE PARTS	
Blade Control Cable	3-5808
Cutter Blade (Mulching)	1-7167
Parts Manual for 19" Steel Deck Walk Behind Mower Series 14 & 15	06066



SNAPPER®

3 YEAR LIMITED WARRANTY

For three (3) years from purchase date for the original purchaser's residential, non-commercial use, **SNAPPER**, through any authorized **SNAPPER** dealer will replace, free of charge (except for taxes where applicable), any part or parts found upon examination by the factory at McDonough, Georgia, to be defective in material or workmanship or both.

For ninety (90) days from purchase date for the original purchaser's commercial, rental, or other non-residential use, **SNAPPER**, through any **SNAPPER** dealer will replace, free of charge, any part or parts found upon examination by the factory at McDonough, Georgia, to be defective in material or workmanship or both.

All transportation costs incurred by the purchaser in submitting material to a **SNAPPER** dealer for replacement under this warranty must be paid by the purchaser.

This warranty does not apply to engines and their components, hydro transmissions, gear drive transmissions and batteries, as these items are warranted separately. This warranty does not apply to parts that have been damaged by accident, alteration, abuse, improper lubrication, normal wear, or other cause beyond the control of **SNAPPER**. This warranty does not cover any machine or component part that has been altered or modified changing safety, performance, or durability.

There is no other express warranty.

DISCLAIMER OF WARRANTY

Implied warranties, including those of merchantability and fitness for a particular purpose, are limited to three (3) years from purchase date for the original purchaser's residential or other non-commercial use, and ninety (90) days from purchase for the original purchaser's commercial, rental or other non-residential use, and to the extent permitted by law, any and all implied warranties are excluded. This is the exclusive remedy. Liabilities for consequential damages, under any and all warranties are excluded.

Some states do not allow limitations on how long an implied warranty lasts, or do not allow the exclusion or limitation of incidental or consequential damages, so the above limitation or exclusion may not apply to you.

This warranty gives you specific legal rights, and you may also have other rights which vary from state to state.

WARNING: THE USE OF REPLACEMENT PARTS OTHER THAN GENUINE SNAPPER PARTS MAY IMPAIR THE SAFETY OF SNAPPER PRODUCTS AND WILL VOID ANY LIABILITY AND WARRANTY BY SNAPPER ASSOCIATED WITH THE USE OF SUCH PARTS.

IMPORTANT: Please fill out the attached **SNAPPER** Product Registration Card immediately and mail to:
Snapper's Product Registration Center, P.O. Box 777, McDonough, Georgia 30253

SNAPPER®

VS. DIRT!

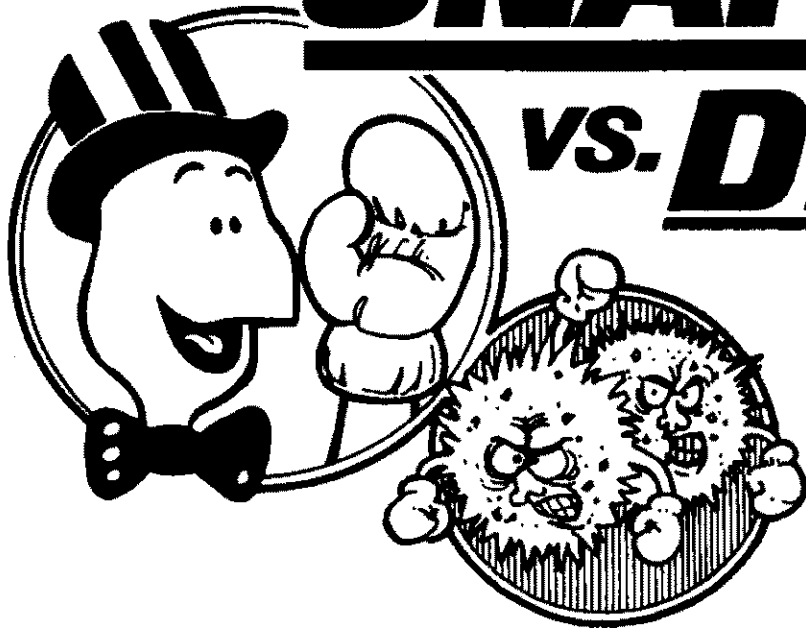

An illustration of how dirt can damage your engine & how reasonable maintenance can protect it!

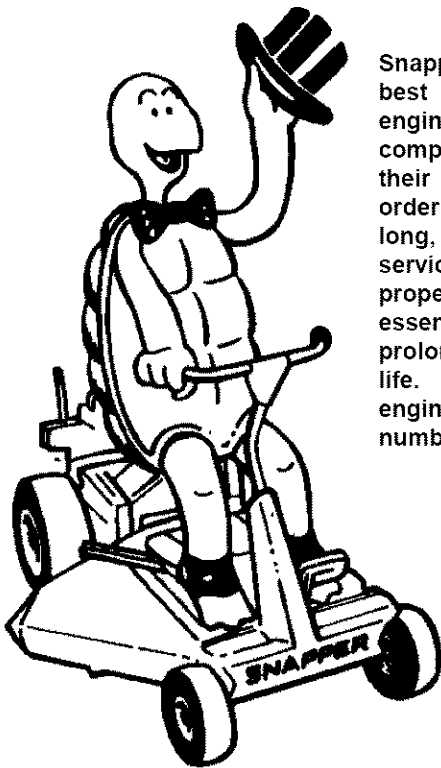

Snapper uses the best available engines and components in their products in order to provide long, satisfactory service. However, proper care is essential in prolonging engine life. Dirt is your engine's enemy number 1!



The engine on your Snapper product spends its entire life operating close to the ground at high speed creating a virtual storm of dust and dirt!

PRIMARY MAINTENANCE

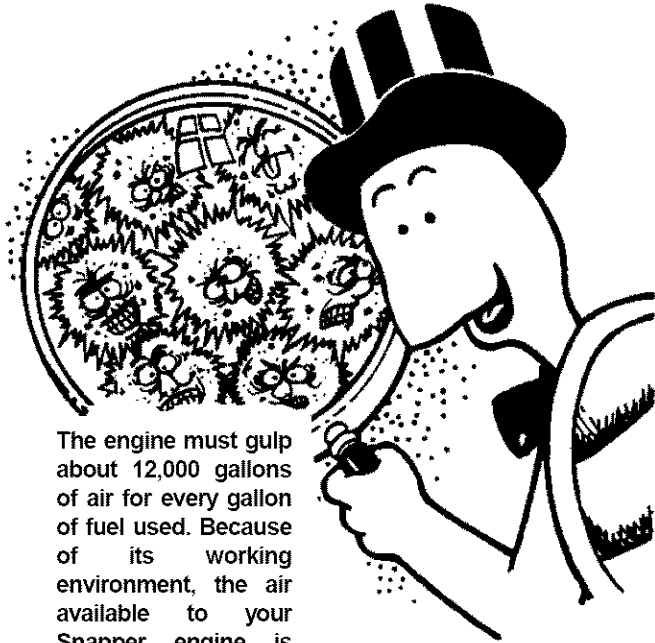

The engine must gulp about 12,000 gallons of air for every gallon of fuel used. Because of its working environment, the air available to your Snapper engine is heavily saturated with airborne dirt particles.

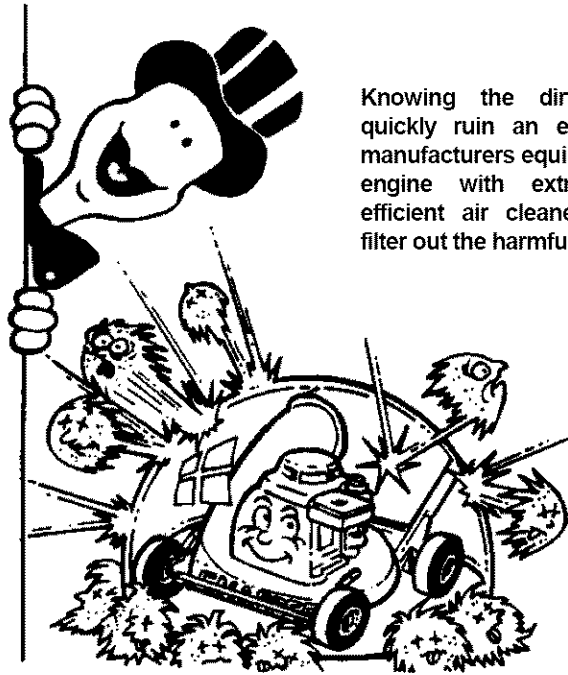

Knowing the dirt will quickly ruin an engine, manufacturers equip their engine with extremely efficient air cleaners to filter out the harmful dirt.

As the dirt particles are stopped, they build up and begin to clog the outside of the air filter. This reduces the amount of air available to the engine and causes an over-rich fuel mixture which results in the following adverse effects:

An improperly serviced, dirt clogged air cleaner will:

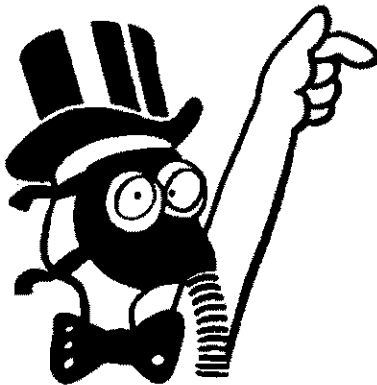

1. Increase fuel consumption.
2. Cause power loss.
3. Result in hard starting.
4. Create smoke from unburned fuel.
5. Produce carbon build-up internally.
6. Foul spark plug electrodes.
7. Score cylinder walls.
8. Burn valves.
9. Wear out the engine pre-maturely.
10. **COST YOU MONEY!**

Damage caused by a poorly serviced air cleaner is not covered under the engine warranties. So, save yourself unnecessary expenses and undue aggravation by keeping the air cleaner properly serviced at the intervals specified in the engine owner's manual.

It doesn't take long to service an air cleaner. Follow the specific instructions in the engine owner's manual for the type filter used. Prevent dirt from falling into the carburetor intake when servicing your air cleaner. Make sure components are installed in correct sequence after servicing to prevent unfiltered air from entering the engine. Some servicing hints on several common types are:

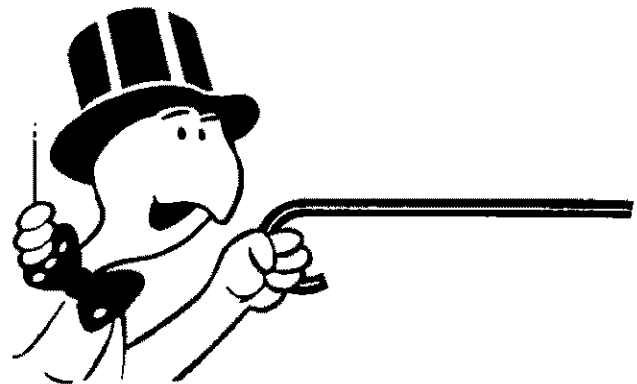

PRIMARY MAINTENANCE

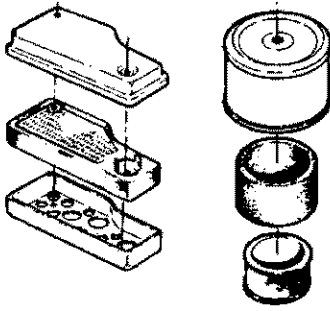

Generally, wash foam-type filters in a dishwashing detergent and water solution. Rinse and wring dry, then saturate with oil and squeeze out excess. *Failure to re-oil this type filter will ruin the engine.*

Clean paper elements by tapping lightly. Blowing with air will rupture paper elements.

Use a flashlight to detect clogged or torn paper elements – replace if damaged in any way.



Air is also needed to keep your engine cool. Dirt, dust & debris build up restricts and clogs cooling air intake screens and fins. Clean screens and fins at frequent intervals. The engine blower housing and shrouds should be removed at least once each season or more often under dry, dusty conditions for a thorough cleaning of fins.

Failure to keep external surfaces clean not only presents fire hazards, but causes overheating and resulting engine damages such as:

1. Distorted valve guides.
2. Sticking Valves.
3. Scuffed, scored cylinder walls.
4. Over-speeding.
5. Loss of power.
6. Complete failure of engine.

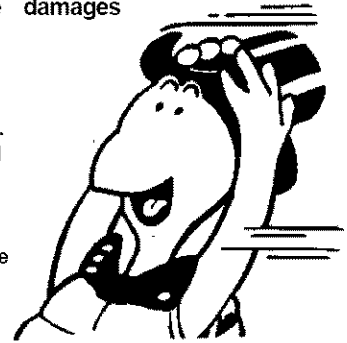

Dirt can also be introduced into an engine in dirty fuel from a contaminated container. Always use clean fresh fuel from a clean container to guard against dirt, sludge and water contamination.



Be aware that fuel breaks down in storage and forms gummy compounds which will block carburetor passages. Never use fuel more than 3 months old. Drain tank then run the engine out of fuel before storing during the off-season.



An engine must also have proper lubrication. All engines use some oil. On 4-cycle engine, CHECK OIL LEVEL BEFORE EACH START-UP. Wipe area clean around the oil check plug or dipstick opening to keep dirt from falling into the engine when checking the oil. Always check with the machine on a level surface. On engines with dipstick, keep the level up to, but not over, the FULL mark. When adding oil, allow time for all of the oil to flow down the fill tube to prevent a false full reading when the level could actually be low and result in engine damage.

PRIMARY MAINTENANCE

On 4-cycle engines with an oil level plug, don't be fooled onto thinking the engine has sufficient lubricating oil if you can see "some" oil in the opening – the level should always be brought up to the point of overflowing at the top of the fill hole.

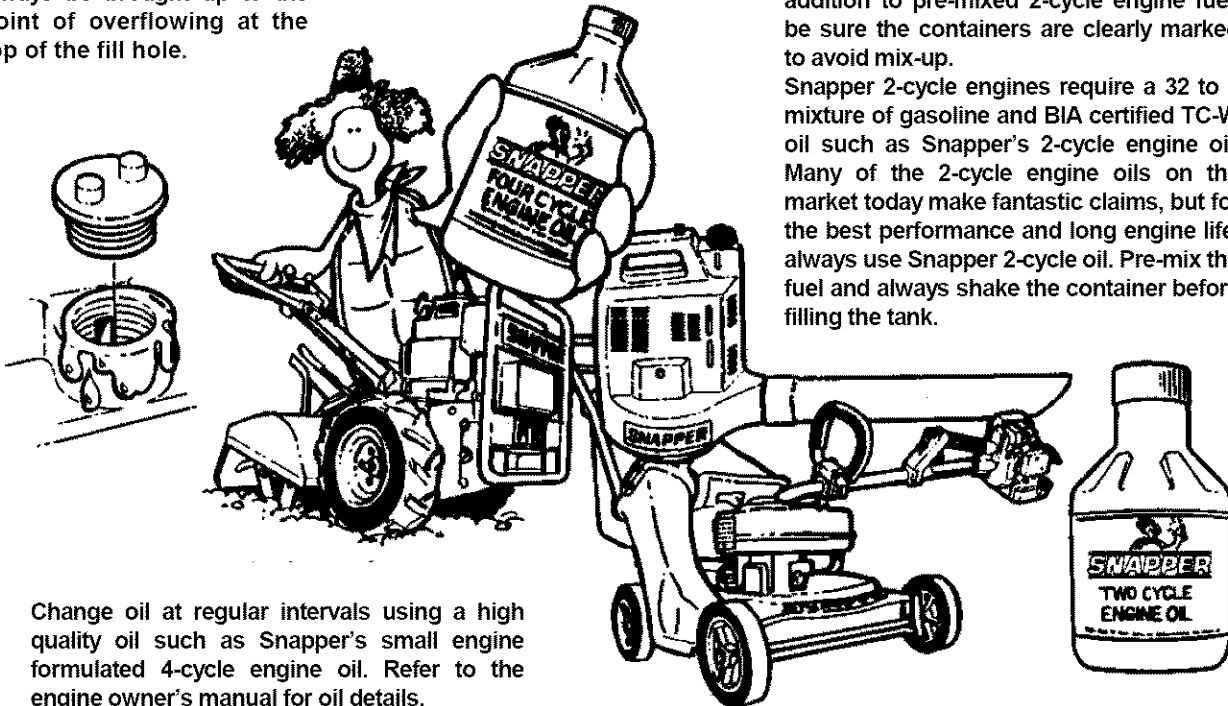

On 2-cycle engines, lubrication must be provided by an exact mixture of gasoline and 2-cycle air-cooled engine oil. A 2-cycle engine that is mistakenly run on straight gasoline will be ruined in less than 5 minutes! If you keep straight gasoline in addition to pre-mixed 2-cycle engine fuel, be sure the containers are clearly marked to avoid mix-up.

Snapper 2-cycle engines require a 32 to 1 mixture of gasoline and BIA certified TC-W oil such as Snapper's 2-cycle engine oil. Many of the 2-cycle engine oils on the market today make fantastic claims, but for the best performance and long engine life, always use Snapper 2-cycle oil. Pre-mix the fuel and always shake the container before filling the tank.

Change oil at regular intervals using a high quality oil such as Snapper's small engine formulated 4-cycle engine oil. Refer to the engine owner's manual for oil details.

- | | |
|------------------------------|---|
| 1. Engine Oil | To full level (4-cycle). Properly mixed with gas (2-cycle). |
| 2. Air Cleaner | Clean and properly serviced. Full fresh clean gasoline. |
| 3. Fuel Tank | Fuel valve open. Cap vent open. Inline filter clean. |
| 4. Choke | Operating properly. |
| 5. Primer (on some engines) | Used properly. |
| 6. Safety Interlock Switches | In proper position. All wires properly connected. |
| 7. Switch & Blade Control | Switch On. Blade control properly positioned on walk mower. |
| 8. Spark Plug | Wire connected. Good connection. |
| 9. Throttle Control | Start Position. |
| 10. Blade | Properly installed and torqued. Sharpened. |
| 11. Muffler | Good condition. Not clogged. Grass & leaves cleaned away. |

Read and follow all safety instructions in safety booklets and manuals.

Keep in mind that dirt is your engine's *enemy #1* both internally and externally! Internally, dirt will quickly ruin an engine and externally it will cause overheating and resulting internal damages. Damage caused by improper lubrication, poor air cleaner service or overheating due to dirt cannot be covered under warranty.

It only takes a few moments to service the engine (and equipment) on a routine basis but the rewards will be a quick starting, responsive engine that will provide long satisfactory service with minimum maintenance cost. The pre-start checklist in the next column and instructions in your Snapper Operator's Manual are designated to help you keep your Snapper in top operating condition with minimum effort!

Safety Instructions & Operator's Manual for

SNAPPER®

19" STEEL DECK

WALK BEHIND MOWERS

SERIES 14 & 15

▲ WARNING: The engine exhaust from this product contains chemicals known to the State of California to cause cancer, birth defects or other reproductive harm.

SNAPPER® McDonough, GA., 30253 U.S.A.

COPYRIGHT © 1998
SNAPPER INC.
ALL RIGHTS RESERVED

MANUAL No. 7-2302 (I.R.11/16/99)