

User Manual Back-UPS™ Pro Gaming UPS BGM1500/BGM1500B

Important Safety Instructions

Inspect the package contents upon receipt. Notify the carrier and dealer if there is any damage.

SAVE THESE INSTRUCTIONS - This manual contains important instructions that should be followed during installation and maintenance of the UPS and batteries.

⚠ DANGER

RISK OF ELECTRIC SHOCK, EXPLOSION, OR ARC FLASH

- This UPS is intended for indoor use only.
- Do not operate this UPS in direct sunlight, in contact with fluids, or where there is excessive dust or humidity.
- Be sure the air vents on the UPS are not blocked. Allow adequate space for proper ventilation.
- Connect the UPS power cable directly to a wall outlet.

Failure to follow these instructions can result in minor or moderate injury and equipment damage.

⚠ CAUTION

RISK OF HYDROGEN SULPHIDE GAS AND EXCESSIVE SMOKE

- Replace the battery at least every 5 years or at the end of its service life, whichever is earlier.
- Replace the battery immediately when the UPS indicates battery replacement is necessary.
- Replace batteries with the same number and type of batteries as originally installed in the equipment.
- Replace the battery immediately when the UPS indicates a battery over-temperature condition, or when there is evidence of electrolyte leakage. Power off the UPS, unplug it from the AC input, and disconnect the batteries. Do not operate the UPS until the batteries have been replaced.

Failure to follow these instructions can result in minor or moderate injury and equipment damage.

Package Contents

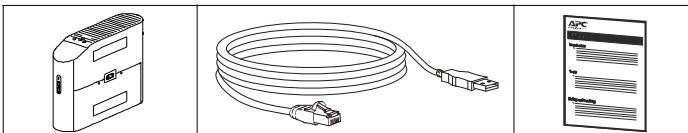

Connect Battery

The UPS is shipped with the battery disconnected.

- 1 Lay the UPS with the battery door facing up. The arrows point to the locking tabs of the battery compartment.
- 2 Press the tabs downwards and pull the battery door away from the unit to access the battery modules.

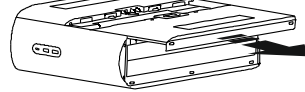
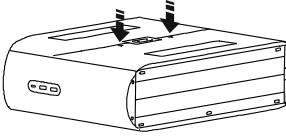

- 3 Using the handles on both sides of the battery, lift the battery 30 degrees upward to expose the battery connector. Connect the red wire as shown above.
- 4 Push the battery into the unit

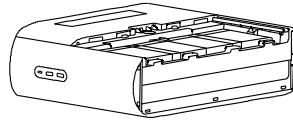
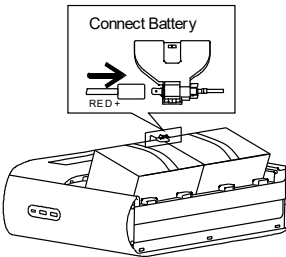

- 5 Align the side rails on the cover with the rails on the UPS and slide the cover till it locks in position.

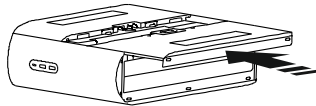

Install PowerChute™ Personal Edition Software

Use PowerChute Personal Edition software to configure the UPS settings. During a power outage, PowerChute will save any open files on your computer and shut it down. When power is restored, it will restart the computer.

NOTE: PowerChute is only compatible with a Windows operating system. If you are using Mac OSX, use the native shutdown feature to protect your system. See the documentation provided with your computer.

Installation

Use the USB Data Port Cable supplied with the Back-UPS to connect the data port on the Back-UPS to the USB port on your computer. Download PowerChute™ Personal Edition Software from www.apc.com/pepe. Select the appropriate operating system and follow directions to download the software.

Connect the Equipment

Battery Backup and Surge Protected outlets

When the Back-UPS is receiving input power, the Battery Backup with Surge Protection outlets will supply power to connected equipment. During a power outage or other AC problems, the Battery Backup outlets receive power for a limited time from the Back-UPS. Connect Gaming PC, Console, router and Monitor to these outlets so you could stay on line during power outage.

Connect equipment such as External Hard Drive, Television or other peripherals that do not need battery backup power to the Surge Protection Only outlets. These outlets provide full-time protection from surges even if the Back-UPS is turned off.

1	USB and Serial Data Port	To use PowerChute Personal Edition, connect the supplied USB communication cable	
2	Ground Screw	Connect the ground lead from an additional surge suppression device such as a stand-alone data line surge protector.	
3	Building Wiring Fault Indicator	If this illuminated, there is a problem with the wiring in the building. Contact an electrician immediately and do not use the Back-UPS.	
4	Coaxial Ports with Surge Protection	Connect a cable modem or other equipment with coaxial jacks.	
5	Circuit breaker Reset Button	Use to reset the system after an overload condition has tripped the circuit breaker interrupt current flow.	
6	Surge Protected Outlets	These outlets provide full-time protection from surges, even if the Back-UPS is off. Connect equipment such as printers and scanners that do not require battery backup protection.	
7	In/Out Ethernet Surge Protected Ports	Use an Ethernet cable to connect a cable modem to the in port, and connect a computer to the OUT port.	
8	Battery Backup Outlets with Surge Protection	During a power outage or other AC problems, the Battery Backup receive power for a limited time from the Back-UPS. Connect critical equipment such as Gaming PC, Console, Router or other gaming gear into these outlets.	
9	Rear LEDs	The Rear LEDs provide 12-color ambient lights to help you add/remove loads from outlets.	

Operation

Top Bezel Buttons and Display Interface

Use the four buttons on the front panel of the Back-UPS and the display interface to configure the Back-UPS.





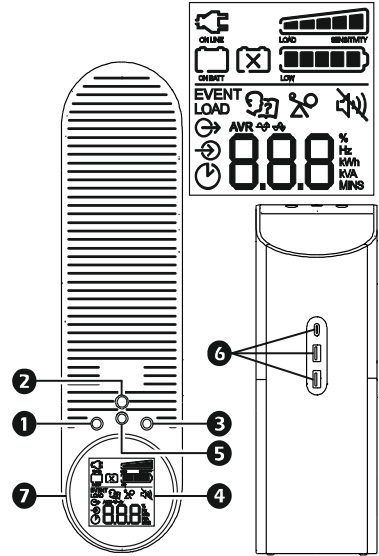



Front Panel

1	INFORMATION button
2	POWER ON/OFF button
3	MUTE button
4	Display interface
5	LED button
6	USB charging ports: The 3 USB ports provide a total of 15W of DC power, and will provide power even when the UPS is on battery.
7	Reactor Circle: Provides 12-color ambient lights.



Display Icons

	On Line: The Back-UPS is supplying conditioned Utility power to connected equipment
	Load Capacity: The approximate load capacity percentage is indicated by the number of load bar sections illuminated. Each bar represents approx 20% of load capacity.
	Battery Capacity: The battery charge level is indicated by the number of bar sections illuminated. When all five bar sections are illuminated, it indicates that the battery is fully charged. When only one bar section is illuminated, it indicates the battery charge is nearing depletion.
	Low Battery: When the battery charge is completely depleted and the UPS is nearing shutdown, the indicator will flash accompanied by a continuous beep.
	Replace Battery: The battery is nearing the end of its useful life and should be replaced immediately.
	On Battery: The UPS is supplying battery power to the connected equipment. The UPS will emit an audible beep once in every 10 seconds.
	System Error Detected: A system error has been detected. The system error number will be displayed on the display interface. Refer "Detected system errors" on page 6, for details.

	Overload: The connected equipment is drawing more power than the rated capacity of the UPS.
	Mute: An illuminated line through the icon indicates that the audible alarm is disabled.
	Out: Output voltage, frequency
	In: Input voltage, frequency
AVR  	Automatic Voltage Regulation:
	When illuminated, the Back-UPS is compensating for low input voltage.
	When illuminated, the Back-UPS is compensating for high input voltage.
	Estimated Runtime: Indicates the remaining runtime (in minutes) in on-battery mode.
LOAD	Load: The total load in watts (W) or percentage (%) used by the devices indicates the remaining runtime (in minutes) in on-battery mode. Event: The number of events that shows up on the LCD screen are the number of power disturbances that your UPS has detected. These disturbances can be any of the following: blackout, under/over voltage, total harmonic distortion, surge, spike, etc.

Unit sensitivity

The higher the sensitivity, the more often the Back-UPS switches to battery power. Adjust the sensitivity of the Back-UPS to control when the UPS will switch over to battery power;

1. Turn off the Back-UPS while connected to a wall outlet.
2. Press and hold the INFORMATION button for six seconds. The Load capacity icon will flash on and off, indicating that the Back-UPS is in programming mode.
3. Press INFORMATION button to navigate through the menu options. Stop at selected sensitivity.

Generator Sensitivity



Default



Sensitive Loads



Low sensitivity

78-150 Vac

Gaming UPS will change to battery mode only when input voltage is extremely low or high. Not recommended for computer or gaming console loads.

Medium sensitivity (Default)

88-147 Vac

This is default sensitivity setting and is recommend for Gaming PC and Gaming consoles.

High sensitivity

88-144 Vac

The connected equipment is sensitive to voltage fluctuations.

Alarms and Detected System Errors

Audible indicators

Overload	Beep every 0.5 second
Low battery	Beep every 0.5 second
Overcharge	Beep every 1.5 seconds
Battery replacement	Beep every 2 seconds
Battery mode	Beep every 30 seconds
Internal error detected	Continuous beep

Detected system errors

If the UPS system does not operate correctly, use the table below to resolve the problem.

F01	Overload fault	Turn the Gaming UPS off. Disconnect non-essential equipment from the Battery Backup outlets and then turn Gaming UPS on.
F02	Output short	Turn the Gaming UPS off. Disconnect all equipment from the Battery Backup outlets and then turn Gaming UPS on. Reconnect equipment one item at a time. If the system error is detected again, disconnect the last connected equipment as it is in an inoperable condition.
F05	Over Charge Voltage	Contact APC by Schneider Electric support
F06	Relay Welding	Contact APC by Schneider Electric support
F07	Over Temperature or NTC disconnected	Contact APC by Schneider Electric support
F08	Fan lock error detected.	Contact APC by Schneider Electric support
F12	Battery mode output high.	Contact APC by Schneider Electric support
F13	Battery mode output low	Contact APC by Schneider Electric support
F28	Low battery voltage	Replace the battery. If the detected error still occurs after battery is replaced, contact APC by Schneider Electric Support

Function	Button	Timing	Description
Power On	POWER ON/OFF	2 seconds	Press and hold the POWER ON/OFF button to turn on UPS.
Power Off	POWER ON/OFF	2 seconds	Press and hold the POWER ON/OFF button to turn off UPS.
Self-Test mode	POWER ON/OFF	6 seconds	Press and hold the POWER ON/OFF button for 6 seconds (buzzer will beep when 6 seconds pass) to go into Self-Test mode when UPS is in Line mode or AVR mode.
UPS Information	INFORMATION	0.2 seconds	Press the INFORMATION button to display UPS information. The information will cycle from Event counter → Runtime → Load watt → Load VA → Load percentage → Output voltage → Output frequency → Input voltage → LCD off.
Sensitivity	INFORMATION	6 seconds	When the UPS is powered off, press and hold the INFORMATION button, the Load Capacity icon will blink, indicating that the UPS is in programming mode. Use the INFORMATION button to scroll through Low, Medium, and High. Stop at selected sensitivity for 5 seconds. The UPS will beep confirming the selection.
Mute	MUTE	2 seconds	Press and hold the MUTE button to enable or disable the audible alarms.
LED Color	LED	0.2 seconds	Click to LED button to select LED Color (There are twelve colors to choose from). The front and rear LED will be synced in color.
Previous LED Color	LED	2 seconds	Press and hold the LED button (till a beep is heard after 2 seconds) to select previous LED Color
Turn on/off the LED lights	LED	6 seconds	Press and hold the LED button to turn on/off the LED lights (buzzer will beep when after 6 seconds pass). The status will cycle through: Front and rear LED on → Front LED on, rear LED off → Front LED off, Rear LED on → Front LED and rear LED off
Event Reset	INFORMATION POWER ON/OFF	0.2 seconds	When the Event screen is visible, press and hold INFORMATION button, then press POWER ON/OFF button to clear the detected event counter.

Status Indicators

Unit Status	Description
Standby	When the unit is plugged into the AC outlet but is turned off, LCD will display battery capacity, input voltage and mute icon. LED ring will be in customized color. In standby mode, the connected equipment will not be protected.
UPS is turning on	All LEDs will light up and the colors will slowly cycle among all available colors. The process should take about 10 seconds.
Equipment is plugged in	The Reactor circle will show the load percentage. The Rear LEDs do not change. Rear LEDs will return to idle state after 10 seconds.
Equipment is unplugged	The Reactor circle will show the load percentage. Rear LEDs do not change. Rear LEDs will return to idle state after 10 seconds.
Idle State	This animation occurs after 10s of inactivity. This occurs every time except when UPS has detected a system error. Rear LED doesn't change (keeps custom/default color). Idle state color is defined by the custom color that user selects (default white). LED illumination in idle state is always at 60% intensity.
Press a button	The LCD will be lit. The unit will switch to idle state after 10 seconds of inactivity.
Power Outage (unit goes on battery)	The Reactor circle will light up to show the runtime percentage, and the displayed percentage will reduce as the runtime reduces. The reactor circle color will be green and blinking if battery life is above 50%, orange and pulsing when battery life is between 20% and 50%, red and flashing when battery life is under 20%.
Low Battery	When the unit is on battery and the battery capacity is low (i.e. when the unit continuously beeps) the reactor circles that is still on will turn red and pulsing - regardless of the color you have selected. The back-light will match this functionality - but only when lighting is enabled.
Overload	The <i>reactor circle</i> lights up in red. It will remain in this state until the unit is no longer overloaded.
Dead Battery	The <i>reactor circle</i> lights up in red. It will remain in this state until the battery is charged or replaced
Building Wiring Fault	The <i>reactor circle</i> lights up in red and pulsing. It will remain in this state until the building wiring fault is no longer detected
Power Surge	All LEDs light up in your chosen color
Power Dip	Rear LED has same behavior as <i>reactor circle</i> .
LCD Information	LCD will cycle through different information when INFORMATION button is pressed. The information will be cycle from Event counter → Runtime → Load watt → Load VA → Load percentage → Output voltage → Output frequency → Input voltage → LCD off. When Runtime is displayed, the Reactor circle color will be green and blinking if battery life is above 50%, orange and pulsing when battery life is between 20% and 50%, red and flashing when battery life is under 20% When Load percentage is displayed, the LED ring color will be green.

Troubleshooting

Problem	Possible Cause	Corrective Action
Back-UPS will not switch on	The Back-UPS is not connected to utility power.	Be sure that the Back-UPS is securely connected to a utility outlet.
	The circuit breaker has tripped.	Disconnect non-essential equipment from the Back-UPS. Reset the circuit breaker. Reconnect equipment one item at a time. If the circuit breaker trips again, disconnect the device that caused the circuit breaker to trip.
	The internal battery is not connected.	Connect the battery.
	The input voltage is out of range.	Adjust the transfer voltage and sensitivity range.
The Back-UPS does not provide power during a utility power outage.	Be sure that essential equipment is not plugged into a surge only outlet.	Disconnect equipment from the surge only outlet and re-connect to a Battery Backup outlet.
The Back-UPS is operating on battery power, while connected to utility power.	Plug is not inserted fully into the wall outlet, the wall outlet is no longer receiving utility power, the circuit breaker has tripped.	Be sure that the plug is fully inserted into the wall outlet. Be sure that the wall outlet is receiving utility power by checking it with another device. Reset the circuit breaker
	The Back-UPS is performing an automatic self-test.	No action is necessary.
	The input voltage is out of range, the frequency is out of range, or the waveform is distorted.	Adjust the transfer voltage and sensitivity range.
The Back-UPS does not provide the expected amount of backup time.	Battery Backup outlets may be fully or improperly loaded.	Disconnect non-essential equipment from the Battery Backup outlets and connect the equipment to surge outlets.
	The battery was recently discharged due to a power outage and has not fully recharged.	Charge the battery for 16 hours.
	The battery has reached the end of its useful life.	Replace the battery.
The Replace Battery indicator is illuminated.	The battery has reached the end of its useful life.	Replace the battery immediately
The Overload indicator is illuminated.	The equipment connected to the Back-UPS is drawing more power than the Back-UPS can provide.	Disconnect non-essential equipment from the Battery Backup outlets and connect the equipment to surge outlets.

Problem	Possible Cause	Corrective Action
The System Error Detected indicator is illuminated, all the front panel indicators are flashing.	An internal error has been detected.	Determine the detected system error by matching the detected error number displayed on the LCD with the corresponding detected system error number in “Detected system errors” on page 6. Contact APC by Schneider Electric support.
Mobile phone is not getting charged through the USB port.	The UPS is in Stand-by mode.	Be sure that the UPS is in On-battery mode or On-line mode.
	Charging cable connector is not fully inserted into the USB port.	Be sure that the charging cable connector is securely inserted into the USB port.
	Charging cable is damaged.	Replace the charging cable. If problem persists even after the charging cable is replaced, contact APC by Schneider Electric support.
	Mobile phone charging standard not compatible.	Try charging another mobile phone which is compliant with USB charging standard BC1.2. If the problem persists with this mobile phone also, contact APC by Schneider Electric support.
	An Internal error has been detected.	Contact APC by Schneider Electric support.

Specifications

	Gaming UPS 1500 VA
Rating	1500 VA
Maximum Load	900 W
Nominal Input Voltage	120 V
Online Input Voltage Range	88 - 147 V
Automatic Voltage Regulation	Boost by +15.7% when input voltage drops below limit Trim by -13.6% when input voltage exceeds limit
Frequency Range	60 Hz ± 3 Hz
On-battery Waveshape	Sinewave
USB charging port	Type C*1, Type A*2 (15 W in total)
Typical Recharge Time	16 hours
Transfer Time	8ms (Typical), 10ms (Max)
Operating Temperature	32 to 104 °C (0 ~ 40 °C)
Storage Temperature	23 to 113 °C (-15 to 40 °C)
Unit Dimensions	16.0 × 4.1 × 11.4 in (408 × 105 × 291 mm)
Unit Weight	25.3 lb (11.5 kg)
Color	BGM1500 - White; BGM1500B - Black
Interface	USB
On-Battery Runtime	Go to: http://www.apc.com/
International Protection Code	IP20

Replacement Battery

The battery typically lasts for 3 to 5 years, a shorter period if subjected to frequent outages or elevated temperatures. Contact APC support for battery replacement parts. Battery replacement parts for BGM1500 and BGM1500B is APCRBC163.

Delaying the replacement of batteries may corrode the batteries in the cartridge. Recycle spent battery cartridges.

Warranty

The standard warranty is three (3) years from the date of purchase. Schneider Electric IT (SEIT) standard procedure is to replace the original unit with a factory reconditioned unit. Customers who must have the original unit back due to the assignment of asset tags and set depreciation schedules must declare such a need at first contact with an SEIT Technical Support representative. SEIT will ship the replacement unit once the defective unit has been received by the repair department, or cross ship upon the receipt of a valid credit card number. The customer pays for shipping the unit to SEIT. SEIT pays ground freight transportation costs to ship the replacement unit to the customer.

APC by Schneider Electric Customer Support

Internet	http://www.apc.com/support
Toll Free	18001030011/18004194272
E-mail	indiainfo@apc.com



Select models are ENERGY STAR[®] qualified.

For more information on your specific model visit the APC by Schneider Electric web site, www.apc.com.



Select models are compliant with California (CEC) Battery Charger regulations.

For more information on your specific model visit the APC by Schneider Electric Web site, www.apc.com.

FCC Radio Frequency Class B Warning

This equipment has been tested and found to comply with the limits for a Class B digital device, pursuant to part 15 of the FCC Rules. These limits are designed to provide reasonable protection against harmful interference in a residential installation. This equipment generates, uses and can radiate radio frequency energy and, if not installed and used in accordance with the instructions, may cause harmful interference to radio communications. However, there is no guarantee that interference will not occur in a particular installation. If this equipment does cause harmful interference to radio or television reception, which can be determined by turning the equipment off and on, the user is encouraged to try to correct the interference by one or more of the following measures:

- Reorient or relocate the receiving antenna.
- Increase the separation between the equipment and receiver.
- Connect the equipment into an outlet on a circuit different from that to which the receiver is connected.
- Consult the dealer or an experienced radio/TV technician for help.