

**CAL/60**

**CAL/80**

**CAL/90**

**230Vac - 50Hz**

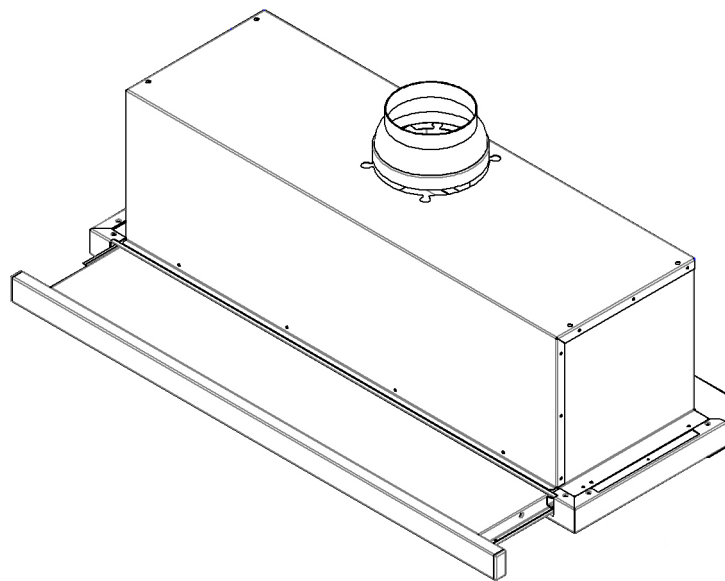

**CE**



# INSTALLATION, OPERATING AND MAINTENANCE INSTRUCTIONS FOR COOKER HOODS FOR WALL FITTING 230 Vac - 50 Hz

Exhausting cooker hood. The equipment is constructed in accordance with European Standards and with the requirements included in the following Directives: 2006/95EC ( Low Voltage Directive), 2004/108 (Electromagnetic Compatibility).

## 1 INSTALLATION

Read the instruction manual before installing and/or using the hood .

In order that the minimum distance between the supporting surface for the cooking pots on gas hob and low-voltage components present in the hood is at least 65cm as required by the regulations in force, it is necessary that the lower part of the hood is at least 65-70cm away from the work top.

If the mounting instructions of the gas cooker indicate a wider distance, respect it. The unit must not be mounted above cookers fitted with top radiant plate.

Respect all the air discharge regulations.

The air must not be discharged in a pipe used to discharge exhaust fumes produced by gas- fed equipments or fuel-fed equipments (this does not apply to filtering hoods).

The room must be adequately ventilated when the hoods is used together with other gas-fed or fuel-fed equipments.

The hood is equipped with all the necessary fastenings for its installation, which are suitable for most surfaces. Anyway, ask to a professional to verify that the installation surface is strong enough. Installation must be carried out by qualified installers according to present regulations.

For an easy access, it is advisable to move possible furniture under the installation area.

Two different wall-mounting systems are used, depending on the model (Fig. 1-2)

- A) Hanging and levelling brackets.
- B) Locking screws.
- C) Hood/chimney fastening screws (if provided)
- D) Chimney/wall bracket and fastening screws.

## 2 ELECTRICAL CONNECTIONS

This appliance must be connected to an earthed power supply. Two types of electrical connection can be used:

1. Using a standard plug to be connected to the power cable and inserted in a mains socket which must be accessible (so that the plug can be disconnected when servicing is carried out). Make sure that the plug is accessible also after the complete installation of the equipment.
2. By means of a fixed mains connection, fitting a bipolar switch, which ensures the disconnection, with an opening distance of the contacts allowing a complete disconnection on the conditions of the overvoltage III category, according to installation regulations. The ground connection (yellow-green wire) must not be interrupted.

Refer to the plate inside the hood for the mains voltage and frequency ratings.

## 3 USE

This cooker hood can be employed as exhausting or filtering.

**Exhausting** (Fig. 4). The carbon filters should not be installed on the hood in exhausting version.

Kitchen smokes are driven outside through a flue joined to the exhaust pipe flue connector..

Pipes must be communicating with the exterior of the house. The

diameter of the outlet of the hood is 150mm. A 150-125 reduction is provided with the hood.

This pipe must not under any circumstances be connected to cooker, boiler or burner exhaust pipes, etc.

**Filtering** (Fig. 5). The fumes pass through the carbon filters to be purified and recycled into the kitchen through a pipe connected to the outlet of the hood up to the hole in the top of the cabinet. This hole must be free and communicating with the kitchen.

In the filtering version you must install the two carbon filters on the sides of the aspirator. To

install the carbon filters you must first remove the metal grease filters (Fig. 6) and then install carbon filters by turning them counterclockwise (Fig. 7).

## 4 OPERATION

The hood is equipped with a multispeed motor.

It is recommended that low speed be selected for normal kitchen conditions, and higher speeds only to combat a heavy build-up odours and vapours.

### ELECTRONIC CONTROLS

The controls (Fig. 7) have buttons for switching on the TL light, for switching on the motor and selecting the T1-T2-T3-T4 operating speed.

By pressing of the command T1 the motor starts running at the 1st speed. The commands T2-T3-T4 switch the motor on respectively at the 2nd, 3rd, 4th speed. In order to switch the motor off press T1 once if set at the 1st speed, twice if set at the 2nd, 3rd and 4th speed.

With the button T4, select the maximum speed of the extraction fan for 5 minutes (LED blinking), after which the extraction fan will automatically switch to the 3rd speed.







				
	0-1	2	3	4
TL	T1	T2	T3	T4

FIG.7

**AUTO POWER OFF:** To activate the auto power off, first turn on the hood and, then, push the "T1" button for a few seconds until all LEDs start flashing. By pressing one of the buttons (T1, T2, T3, T4) it is possible to program the auto power off time, which will be different according to the button pressed (T1= 5 minutes, T2=10 minutes, T3=15 minutes, T4=20 minutes). The set speed can be changed during the auto power off time. When the auto power off option corresponds to the previously set speed, the speed LED flashes; if the option is different, the speed LED is fixed.

**FILTER TIMER:** After the hood has worked for 30 hours, all LEDs will switch on with a fixed light for 30 seconds when the hood is turned off indicating that the aluminium filters need to be cleaned. The timer will reset if the T1+T4 button is pressed for a few seconds with the exhaust fan turned off. If this button is not pressed, the same operation will occur again once the hood is switched off again. This operation will occur every 30 hours, until 120 functioning hours are reached. Once the hood has worked for 120 hours and it is turned off, all the LEDs will turn on with a flashing light for the following 30 seconds indicating the that

aluminium filters need cleaning and, if the hood is a filtering hood, the active carbon filters need to be replaced.

Once the timer has been reset (by keeping the T1+T4 button pressed for a few seconds with the exhaust fan turned off), the entire process will present itself again after the next 30 exhausting hours.

## **5 MAINTENANCE AND REMINDERS**

Always disconnect the hood from the electrical power supply before any maintenance or cleaning operation. Particular care must be given to the grease filters, which serve to trap grease particles entrained in cooking vapours.

The grease filters are metal, and must be washed at least once a month with warm water and detergent (dishwasher clean is sufficient).

Dry thoroughly before refitting.

**ATTENTION:** the grease collected in the filter can easily catch fire and it is therefore extremely important to clean the metallic filter on a regular basis as per instructions.

Grease filters are removed as illustrated (Fig. 5).

The function of the activated carbon filters is to prevent the spread of odours present in the cooking fumes. Clean air is returned to the kitchen. Carbon filters cannot be washed, and must be replaced 2 or 3 times a year according to the amount of use.

The hood features a LED light that, in addition to offer a good lighting and a significant energy savings, is guaranteed to last about 10 times more than traditional lights. For replacement, contact the Assistance Service.

Spare filters can be purchased from dealers or direct from the manufacturer.

**Removal:** detach the metal covers and rotate the carbon filters clockwise (Fig. 6) until release from of the motor.

**Refitment:** position the new carbon filters and reverse the procedure. The hood should be cleaned with a soft damp cloth using neutral liquid detergents. Do not use solvents, petroleum products or abrasives.

Never cook flambe' dishes under the hood. Never leave the hob unattended when frying, as oil or fat can catch fire.

**THE MANUFACTURER DOES NOT ACCEPT LIABILITY FOR ANY DAMAGE OR INJURY CAUSED IF THE USER FAILS TO FOLLOW THE ABOVE INSTRUCTIONS REGARDING INSTALLATION, MAINTENANCE AND THE PROPER USE OF THE COOKER HOOD.**

