

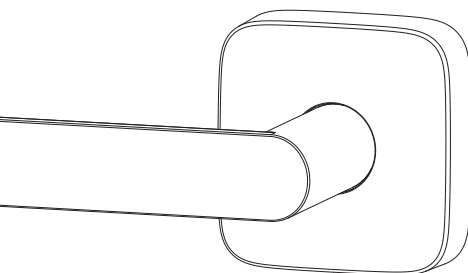

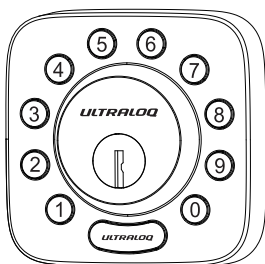





ULTRALOG

Bolt Z-Wave Installation and User Guide (V3.1)



Important Notes

-  Install and test the lock with the door open to avoid being locked out.
-  Please read and follow the instructions carefully before contacting customer support.
-  Before returning the lock, please remove the device from the app settings and contact customer support.
-  Operating temperature ranges:
 - Exterior:** -4 °F (-20 °C) to 149 °F (65 °C)
 - Interior:** 14 °F (-10 °C) to 131 °F (55 °C)
-  Do not use a power drill for installation.
-  Do not install the batteries before installing the lock.
-  Rechargeable batteries or non-alkaline batteries are not recommended. Use AA alkaline batteries only.

Note: The Exterior Assembly of the Bolt Z-Wave is waterproof, but the Interior Assembly is not waterproof due to the exposed battery compartment.

Statements

To ensure the best service, please create your account at www.ultralq.com/register before using the product.

Terms & Policies

Before using any ULTRALOQ products, please read all applicable terms, rules, policies and usage provisions found at www.ultralq.com/privacy. By using your ULTRALOQ, you agree to be bound by the ULTRALOQ Privacy Policy.

Need Help?

For technical documents and more

Please visit support.ultralq.com

or call 1-844-439-8832

Packing List

Interior Assembly

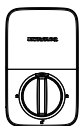

Exterior Assembly



Interior Assembly Mounting Plate



Strike



Bolt

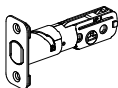

Reset Needle



Screw A

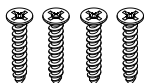

Screw B

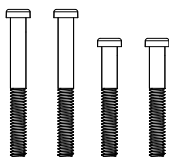

Screw C



Screw D



Door Sensor

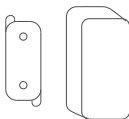

Backup Keys



Drill Template

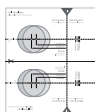

AA Alkaline Batteries

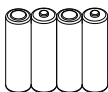

May not be included for some regions

User Guide



Installation Guide

Installation Video



Please scan the QR code to watch the installation video.

Or you can also view the website directly.
www.ultraoq.com/bolt-z-wave/guide.

1. Prepare the door and check dimensions

Step 1

Confirm that the door thickness is 1-3/8" to 2-1/4" (35 mm-57 mm).

Step 2

Measure to confirm that the diameter of the hole is 2 1/8" (53 mm) or 1 1/2" (38 mm).

Step 3

Measure to confirm that the backset is either 2 3/8" or 2 3/4" (60 mm or 70 mm).

Step 4

Measure to confirm that the diameter of the hole in the door edge is 1" (25 mm).

Step 5

Measure to confirm the depth of the hole in the frame is at least 1"(25mm).

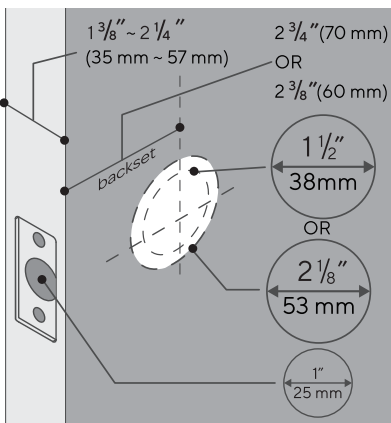
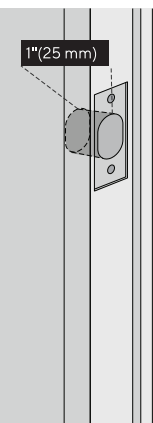

If you have a new door, please drill the holes according to Drill Template.

2. Installing Bolt and Strike

Step 1: Install the Bolt

Insert the bolt into the door. Making sure the "UP ↑" icon faces upward.

Note: The bolt is set for a 2-3/8" (60mm) backset by default.

To adjust to 2-3/4" (70mm): Make sure the bolt is fully retracted. Press the bolt, then twist it until you feel a slight click. This locks it in the extended backset position.

Note: Always ensure the bolt is retracted before making adjustments.

Step 2: Install the Strike

Align the strike plate with the door frame.

Secure it in place using the provided screws A(x4)

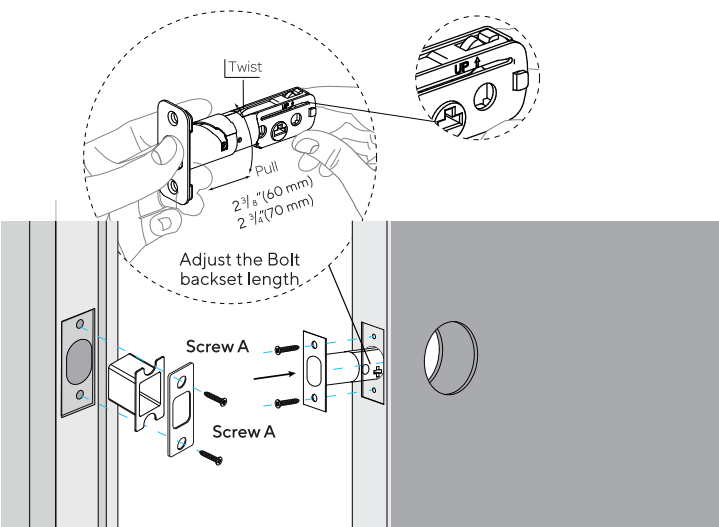

3. Installing the Exterior Assembly

Step 1: Position and Install

Ensure the bolt is fully retracted.

Make sure the cylinder tailpiece is horizontal, with the raised section facing up.

Carefully install the Exterior Assembly onto the door.

Note: Do not insert the mechanical key during installation.

Step 2: Route the Cable

Carefully thread the cable through the hole located below the bolt to the interior side of the door.

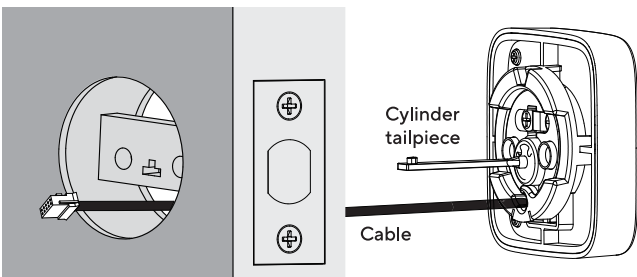

If your door has a 1½" (38 mm) bore hole, remove the spacer as shown. If not, don't remove it.

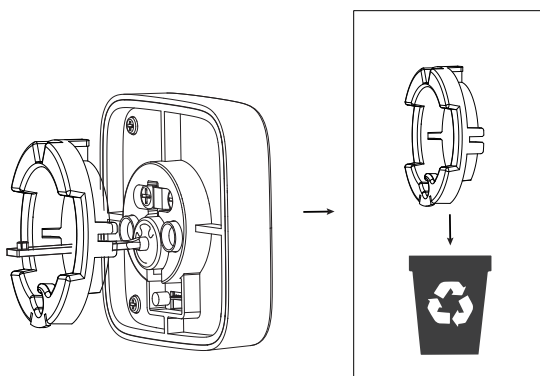

With No Spacer

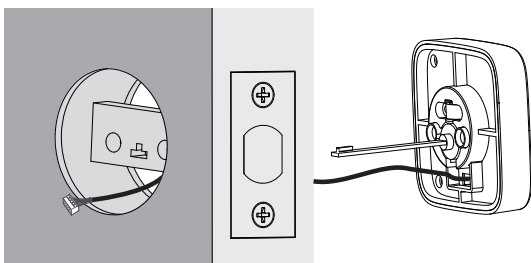

4. Installing the Interior Assembly Mounting Plate

Step 1: Route the cable

Route the cable through the hole in the Interior Assembly Mounting Plate.

Step 2: Secure the Mounting Plate

Secure the Interior Assembly Mounting Plate to the Exterior Assembly using Screw B(x2).

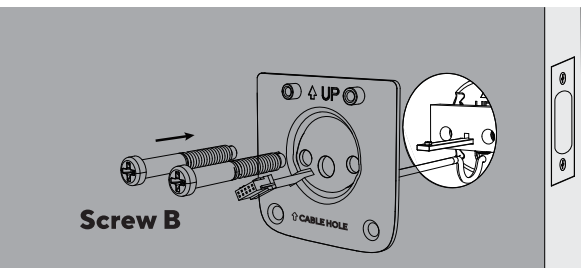

Warning: Longer screws for 1-3/4"~ 2-1/4" (45mm~57mm) thickness door, Shorter screws for 1-3/8"~ 1-3/4" (35mm~45mm) thickness door.

5. Installing the Interior Assembly

Warning: Do not install the batteries before installing the interior assembly, as this may prevent the keypad from powering on properly.

Step 1: Remove Battery Cover

Remove the battery cover from the Interior Assembly.

Step 2: Connect the Cable

Insert the cable connector into the socket on the Interior Assembly.

Make sure the concave and convex sides are aligned.

Press firmly until the connector is fully seated.

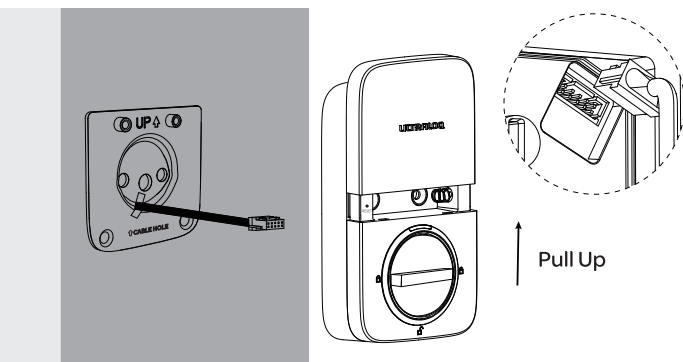

Step 3: Set to Unlocked Position

Rotate the knob to the vertical position to keep the lock unlocked during installation.

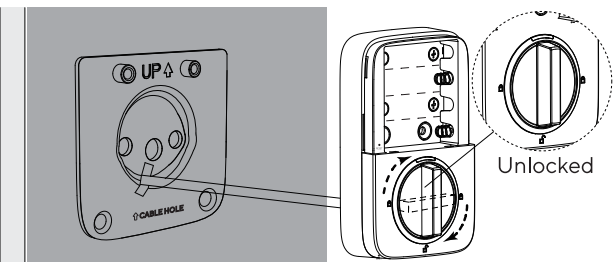

Step 4: Attach and Secure

Align the Interior Assembly with Mounting Plate.

Use Screw C(x2) to secure the Interior Assembly in place.

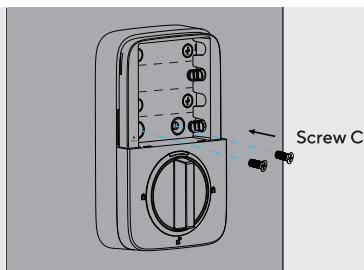

6. Installing the Batteries and Performing the Door Handling Process

This step helps your lock learn which way your door opens, so it can work properly.

Step 1: Set to unlocked position

Rotate the knob to the vertical position to keep the lock unlocked.

Step 2: Insert Batteries

Insert 4 AA alkaline batteries into the battery compartment. Reattach the battery cover.

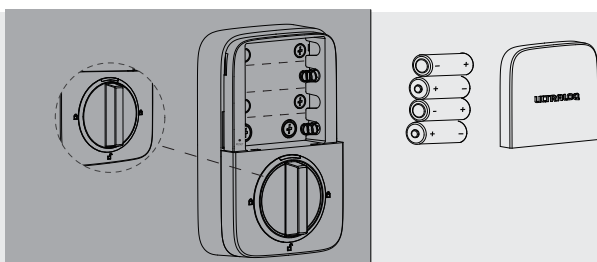

Note: Only the Program Code on the battery cover can unlock Bolt Series in Factory Default Mode.

Step 3: Perform Direction Calibration

Keep the bolt in the unlocked position, then press and hold the “5” key for 3 seconds until you hear 2 beeps.

The lock will automatically rotate and begin self-calibrating the door direction, which will complete in approximately 5 seconds.

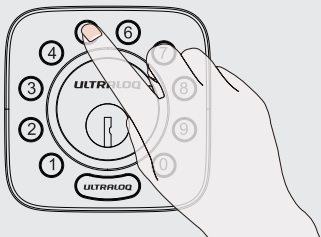

Note: To prevent deadbolt jamming, ensure this step is performed after the lock is installed on the door.

Step 4:

Keep While in Factory Default Mode, enter the program code located on the battery cover. Then press the ULTRALOCK button to unlock the Bolt Z-Wave.

7. Installing the Door Sensor(Optional)

Door sensor lets you know whether the door is open or closed through the App.

When Auto-Lock is enabled, your LOCK will automatically lock only when the door is fully closed.

Guidelines:

Do not mount the door sensor on the keypad side of the lock. Avoid installing the sensor on metal doors that interfere with the internal magnet. (In such cases, the door sensor may stick to the metal door magnetically and malfunction.)

The sensor is suitable for:

Wooden doors.

Metal doors that do not interfere with the sensor's magnetic field (i.e., the sensor does not stick magnetically to the door).

Installing with Screw D

Drill two holes at the marked positions.

Press the door sensor against the wall and secure it using Screws D (x2).

Attach the door sensor cover by sliding it from top to bottom along the chute until it clicks into place.

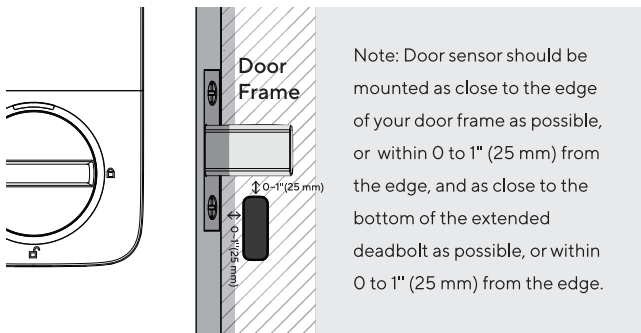
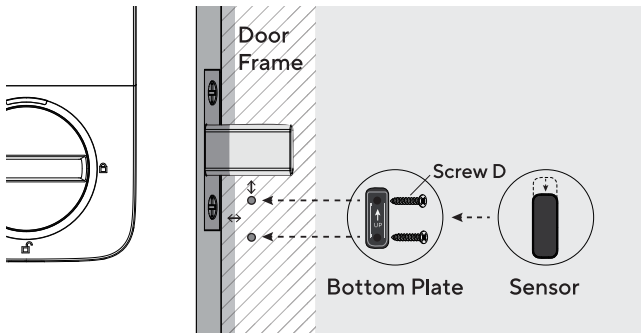

Note: The door sensor must be configured through your smart home system. For more details, please refer to your controller's website or user documentation.

For the associated parameters of the door sensor, see the "Z-Wave Association and configuration Parameters" document at www.ultraq.com/bolt-z-wave/guide.

User Guide

User Guide Video

Please scan the QR code to watch the user guide video.
Or you can also view the website directly,
www.ultralq.com/bolt-z-wave/guide



1. Product Overview

1.1 Exterior Components

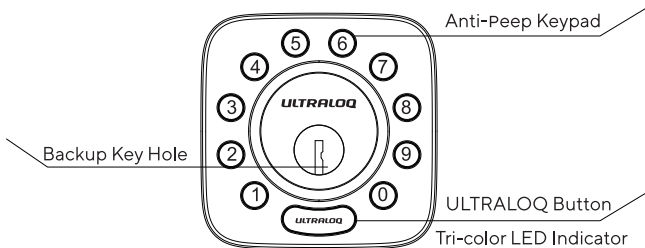

① Anti-Peep Keypad

Supports secure code entry by allowing random digits before or after the correct code.

② Backup Key Hole

Allows mechanical key access in case of battery failure or in other emergency situations.

ULTRALQ Button

Used to manually lock/unlock the door, illuminate the keypad, and confirm actions.

Tri-Color LED Indicator

Green: Lights up when manual programming is successful or when your entry is verified.

Red: Lights up when manual programming fails or when entry verification is incorrect.

Blue: Lights up when entering Standalone Mode.

Flashing Blue: Indicates Setup Mode (ready to connect with your smart home system).

1.2 Interior Components

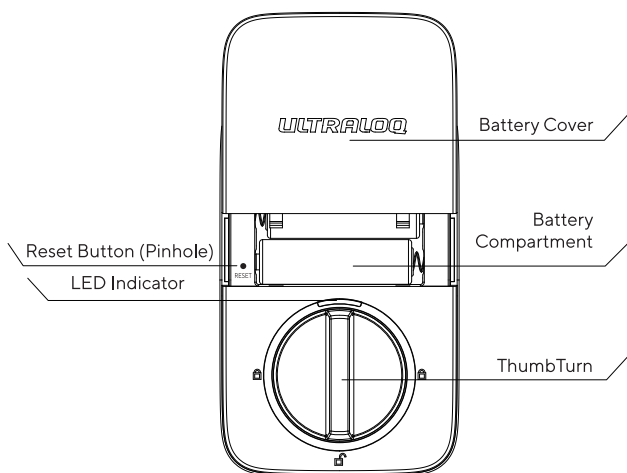

Reset Button(Pinhole)

Used to reset the lock to Factory Default settings.

To reset, use a Reset Needle to press and hold the reset button (located under the battery cover) for about 10 seconds until you hear one long beep followed by two short beeps.

Battery Compartment

Hold 4 AA alkaline Batteries.

Note: Insert 4 AA alkaline Batteries or UTEC Lithium Batteries. Rechargeable or other battery types are not recommended.

Battery Cover

Protects the battery compartment and includes labels for the Program Code and the Z-Wave setup code.

Thumb Turn

Used to manually lock and unlock the door from inside.

LED Indicator

Green: Door is unlocked

Flashing Green: Lock is in setup mode

1.3 Low Battery Alarm

When the battery is low:

A low battery alert will be triggered on the lock and through your smart home system.

The ULTRALOQ Button will flash red and emit beeps when the lock is retracted.

Please replace the batteries promptly to avoid lock failure.

2. Z-wave Function

2.1 About Z-Wave

This lock is a Security-Enabled Z-Wave Plus® product. A security-enabled controller (S2) is required for full functionality.

The lock can be included in any Z-Wave network, enabling remote control via compatible systems from any manufacturer or service provider.

Listening nodes (repeaters) from any brand can help extend the Z-Wave network range.

If the lock is paired with a non-secure controller, functionality will be limited.

2.2 Adding Your Lock to a Z-Wave Network

Step 1

Activate Inclusion Mode on Your Hub.

Follow your smart hub's instructions to put it into Z-Wave inclusion mode.

If using SmartStart Enabled Products:

SmartStart enabled products can be added into a Z-Wave network by scanning the Z-Wave QR Code present on the product with a controller providing SmartStart inclusion. No further action is required and the SmartStart product will be added automatically within 10 minutes of being switched on in the network vicinity.

Step 2

Put the Lock in Setup Mode.

If your smart home system prompts you to add the lock:

Press and hold the ULTRALOCK button for 3 seconds.

You will hear two beeps, see a flashing blue light, and the internal LED will flash green.

The lock is now in setup mode (Include Mode).

Step 3

Complete Pairing.

Follow your system's prompts to:

Scan the QR code located on the battery cover, or

Enter the 5-digit DSK PIN code (also on the label).

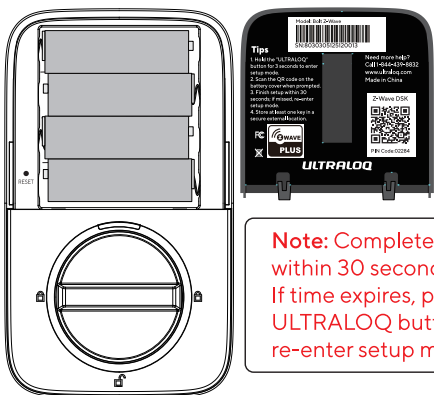

Note: Complete the pairing within 30 seconds. If time expires, press the ULTRALQO button again to re-enter setup mode.

2.3 Removing Your Lock (Z-Wave Exclusion)

• Enter Exclusion Mode on Your Hub:

Follow your smart hub's user guide to activate Z-Wave exclusion mode.

• Put the Lock in Exclusion Mode:

Press and hold the ULTRALQO button for 3 seconds.

You will hear two beeps, see a flashing blue light, and the internal LED will flash green.

The lock is now in exclusion mode.

• Complete Removal:

Follow the hub's prompts to remove the lock from your Z-Wave network.

Your lock is now disconnected and ready for re-inclusion or factory reset if needed.

3. Using Your Lock

3.1 Unlocking From Outside

You can unlock the LOCK using any of the following methods:

• Using a User Code

Enter your 4-8 digit code, then press ULTRALQO button to unlock.

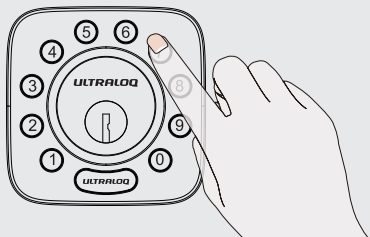

Note: Press any button to activate the keypad backlight before entering your code.

• Using your smart home controller

You can also unlock the door using your smart home system. Please refer to your smart home system's instructions for detailed steps.

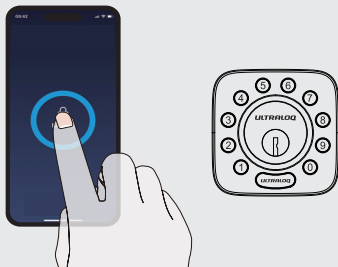

3.2 Locking From Outside

Press the ULTRALOQ button to lock manually.

Enable the Auto Lock feature to have the lock automatically relock after the door is closed.

3.3 Unlocking From Inside

Rotate the thumb turn to the vertical position to unlock.

3.4 Resetting the Lock

If you've already removed the lock from your smart home system but it hasn't reset automatically:

Use a Reset Needle to press the Reset Button under the battery cover for 10 seconds, until you hear 1 long beep followed by 2 short beeps.

Note: Resetting the Bolt Z-Wave to factory default will erase all user data and settings.

3.5 Replacing the Batteries

Replace with 4 high-quality AA alkaline batteries when the current batteries run out.

Rechargeable or non-alkaline batteries are not recommended.

3.6 Emergency Key Override

Use the mechanical key to unlock the door if the batteries are dead.

Important: Keep at least one backup key in a secure location outside your home.

3.7 Auto Lock

The default Auto Lock delay is 30 seconds. You can adjust this timing through your smart home system settings.

3.8 Anti-Peep Keypad

The lock supports a Vague Code (anti-peep feature) of up to 16 digits. As long as your correct user code appears in the correct sequence within the digits entered, the door will unlock.

Example
User Code: 123456

Valid Vague Codes

123456XXXXXX

XXXXXXXX123456

XXX123456XXX

"X" represents any random digit. The correct code must appear in order, even if surrounded by other digits.

4. Standalone Mode Programming Guide

While it's recommended to use a smart home system to manage your lock, you can also program it manually using Standalone Mode.

Warning : Standalone Mode is NOT available once the lock is registered with a smart home system. To re-enable Standalone Mode, you must reset the lock to factory default settings.

4.1 Add Admin Code in Standalone Mode

To add the Admin Code, you need the Program Code found on the battery cover.

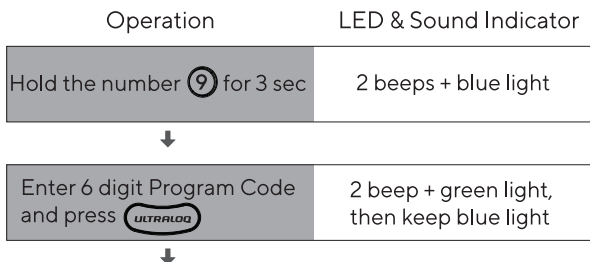

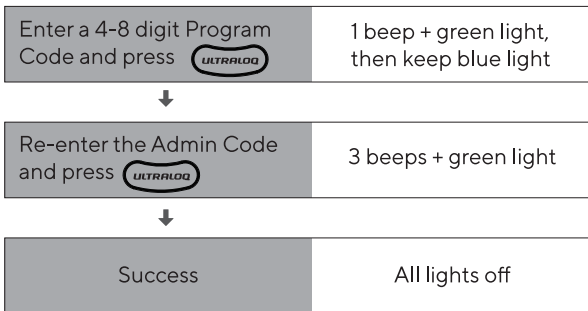

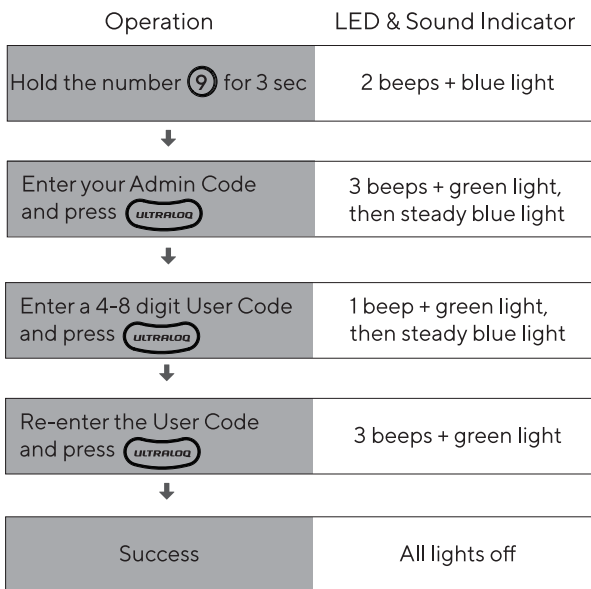

4.2 Add User Code in Standalone Mode

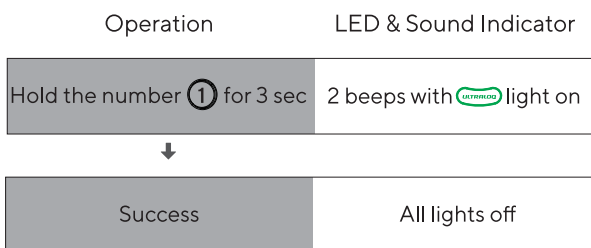

4.3 Enable Auto-lock Function



4.4 Disable Auto-lock Function

Operation	LED & Sound Indicator
Hold the number 0 for 3 sec	2 beeps with  light on
↓	
Success	All lights off

4.5 Delete Admin and User Codes

To delete the Admin Code and all User Codes, reset the lock to Factory Default Mode.

4.6 How to Reset in Standalone Mode?

Use a Reset Needle to press the Reset Button under the battery cover.

Hold for 10 seconds, until you hear 1 long beep followed by 2 short beeps.

The lock is now reset and ready to be programmed again in Standalone Mode.

FAQ

1. How do I reset the Bolt Z-Wave?

Note: Resetting the lock will erase all data, including Admin and User Codes. You can reset the lock from your smart home system by removing it.

If you've already removed the lock from your smart home system but the lock hasn't reset itself:

Use a Reset Needle to press the Reset Button under the battery cover.

Hold for about 10 seconds until you hear 1 long beep followed by 2 short beeps.

2. How can I control the Bolt Z-Wave remotely?

The Bolt Z-Wave is a smart lock that supports Z-Wave technology. Add it to your smart home system to enable remote control through your system's app or interface.

3. How do I adjust the lock orientation of the Bolt Z-Wave?

You can adjust the lock orientation directly on the device. Refer to page 7 of this manual for full instructions.

4. What if the battery dies-how do I unlock the Bolt Z-Wave?

A low battery alert will appear on both the lock and your smart home system.

The ULTRALOCK Button will flash red and beep when the lock is activated under low battery conditions.

Please replace the batteries promptly.

If the battery is fully drained, use the mechanical backup key to unlock the door.

5. Can I use third-party accessories (e.g., bolt)?

It is recommended to use the original ULTRALOCK accessories for best performance and stability.

ULTRALOOQ

A Brand of Xthings

© 2025 Xthings Inc. All rights reserved.

ULTRALOOQ and ULTRALOOQ logo are trademarks of Xthings Inc. or its affiliates registered in the U.S. and other countries and regions. All other trademarks are the property of their respective owners.

Xthings Inc. 47703 Fremont Boulevard, Fremont, CA 94538

Engineered by Xthings, assembled in China.