

ARCTIC AIR COMMERCIAL CHEST FREEZER

Table of Contents

Product Registration	2
Important Safety Instructions	2
Electrical Information	2
Installation and Setup	3
Appliance Start-Up	3
Features	3
Routine Maintenance	4
Power Failure	4
Energy Conservation Measures	4
Troubleshooting Guide	5-6
If You Need Service	6
Wiring Diagram	7
Warranty	8

Product Registration

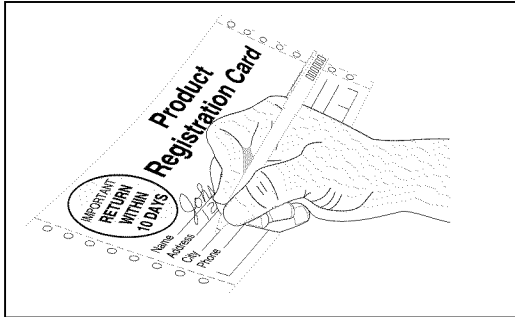

The information contained within this Owner's Guide will instruct you on how to properly operate and care for your product. Please read through the information contained in your literature pack to learn more about your new appliance. The serial plate is located on the outside left wall of freezer.

Record Your Model and Serial Numbers

Record the Model No. and Serial No. of this appliance in the space provided below.

Model No.: _____

Serial No.: _____

Register Your Product

The self-addressed PRODUCT REGISTRATION CARD (shown above) should be filled in completely, signed and returned to the address provided.

Important Safety Instructions

Read all instructions before using this appliance.

⚠ WARNING For Your Safety

Do not store or use gasoline or other flammable vapors and liquids in the vicinity of this or any other appliance. Read product labels for flammability and other warnings.

⚠ WARNING Child Safety

- Destroy carton, plastic bags, and any exterior wrapping material immediately after the appliance is unpacked. Children should never use these items for play. Cartons covered with rugs, bedspreads, plastic sheets or stretch wrap may become airtight chambers and can quickly cause suffocation.
- A child might suffocate if he crawls into the appliance to hide or play. Remove the door of the appliance when not in use, even if you plan to discard the appliance. Many communities have laws requiring you to take this safety precaution.

Proper Disposal of Your Refrigerator/Freezer

⚠ DANGER Risk of child entrapment. Child entrapment and suffocation are not problems of the past. Junked or abandoned refrigerators or freezer are still dangerous — even if they will sit for "just a few days." If you are getting rid of your old refrigerator or freezer, please follow the instructions below to help prevent accidents.

BEFORE YOU THROW AWAY YOUR OLD REFRIGERATOR/FREEZER:

- Remove doors.
- Leave shelves in place so children may not easily climb inside.

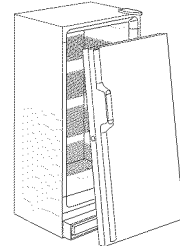

⚠ WARNING Electrical Information

These guidelines must be followed to ensure that safety mechanisms in the design of this appliance will operate properly.

⚠ WARNING Avoid fire hazard or electric shock. Do not use an extension cord or an adapter plug. Do not remove any prong from the power cord.

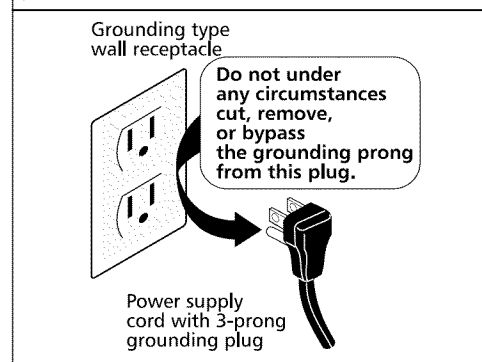

- **Refer to the serial plate for correct electrical rating.** The power cord of the appliance is equipped with a three-prong grounding plug for protection against shock hazards. It must be plugged directly into its own properly grounded three-prong receptacle, protected with a 15 amp time delay fuse or circuit breaker. The receptacle must be installed in accordance with the local codes and ordinances. Consult a qualified electrician. Receptacles with Ground Fault Circuit Interrupters (GFCI) are NOT RECOMMENDED. **DO NOT use an extension cord or an adapter plug.**
- If voltage varies by 10 percent or more, appliance performance may be affected. Operating the appliance with insufficient power can damage the motor. Such damage is not covered under the warranty. If you suspect your voltage is high or low, consult your power company for testing.

- To prevent the appliance from being turned off accidentally, do not plug the unit into an outlet controlled by a wall switch or pull cord.
- Do not pinch, knot, or bend the power cord in any manner.

⚠️ WARNING Other Precautions

- Never unplug the appliance by pulling on the power cord. Always grip the plug firmly and pull straight out from the receptacle.
- To avoid electrical shock, unplug the appliance before cleaning.

Note: Turning the control to OFF turns off the compressor, but does not disconnect power to other electrical components.

Installation and Setup

Inspection for Damage

Inspect the underside of the cabinet and packaging for damage such as a fork truck can cause. If hidden damage is found after uncrating, immediately call the delivery carrier and request an inspection. Retain all packaging and crating materials until the inspection is complete.

Uncrating and Set-Up

- Using a utility knife with a sharp, short blade, cut along the perimeter of the carton as indicated.
- Lift the carton off the freezer.
- Remove the package containing the casters from the freezer. This package will contain the following items:
 - One (1) wrench
 - Sixteen (16) screws
 - Four (4) casters

Casters:

- Tape door closed to prevent door from opening when freezer is tilted back.
- With an assistant, tilt the freezer until it is resting on its back. Take care to protect the back from being scratched during this process.
- Using the wrench provided and the sixteen (16) screws, install all four (4) casters in the tapped holes in the bottom of the unit. Tighten securely.
- With an assistant, tilt the freezer back up onto the casters.

Appliance Placement

Leave a three (3) inch space on all sides and the back of the cabinet for adequate air circulation. Choose a place that is near a grounded electrical outlet. For the most efficient operation, the appliance should be located where surrounding temperatures will not exceed 110°F (43°C). Appliance should not be operated in ambient below 32°F (0°C). Additional compressor heaters are not recommended.

Insulation

The insulated space of this cabinet is sealed to maintain peak efficiency. Holes drilled in the cabinet may destroy that seal and damage electrical wiring located in the insulated space.

Damaged electrical wiring or wet insulation caused by drilling will void the warranty.

Appliance Start-Up

Once the appliance has been located in its permanent location and the proper power and grounding has been provided, the following items must be checked or completed:

Cool Down Period

For safe food storage, allow 24 hours for the appliance to cool down completely before loading with food. The appliance will run continuously for the first several hours. Do not place any food in the appliance until after the first 24 hours of operation.

Thermostat Settings

The appliance is shipped from the factory with the thermostat set at about the mid-point of the operating range. Adjustments colder or warmer can be made after the appliance has been running for at least 8 hours. Allow at least 8 hours for temperature stabilization before re-adjusting the thermostat.

Features (Some Models)

- Heavy duty epoxy powder coated slide-aside basket
- Security lock with pop-out key
- Fiberglass lid insulation
- 2-1/2" urethane foam cabinet insulation
- Counterbalanced lid
- Heavy duty swivel casters
- Adjustable temperature control
- NSF certified interior
- Heavy duty commercially rated electrical harness
- Defrost Drain

4 Swivel Casters

The appliance comes with 4 swivel casters. The casters allow the appliance to be moved with ease. Refer to the *Installation and Setup* section for instructions.

Slide-Aside Basket

This basket helps organize odd-shaped items. To reach other packages in the freezer, slide the basket aside or lift out.

Security Lock with Pop-Out Key (Some Models)

This security lock fastens the door snugly, ensuring that stored food is secure. To lock or unlock the freezer, slide the key into the lock and turn. The key pops out of the lock after it has been turned.

Adjustable Temperature Control

The adjustable thermostat control is located on the left outside wall of the unit.

Interior Thermometer (Some Models)

The appliance comes with a thermometer to show internal temperatures. The thermometer is attached to the interior door panel.

Routine Maintenance Between Defrostings

To avoid frequent defrosting, occasionally use a plastic scraper to remove frost. Scrape with a pulling motion. Never use a metal instrument to remove frost.

Defrosting

It is important to defrost and clean freezer when $\frac{1}{4}$ to $\frac{1}{2}$ inch of frost has accumulated. Frost may tend to accumulate faster on upper part of the freezer due to warm, moist air entering the freezer when the lid is opened. Remove food and leave the lid open when defrosting the freezer.

To use the defrost drain, place a shallow pan beneath the drain outlet (Figure 1). Pull out the drain plug inside the freezer, and pull off the outside defrost drain plug (Figure 2). Defrost water will drain out. Check pan occasionally so water does not overflow. Replace the drain plugs when defrosting is completed.

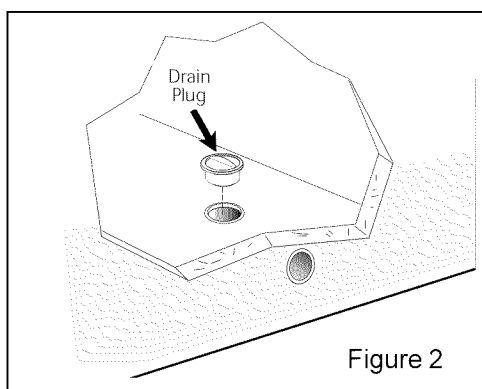
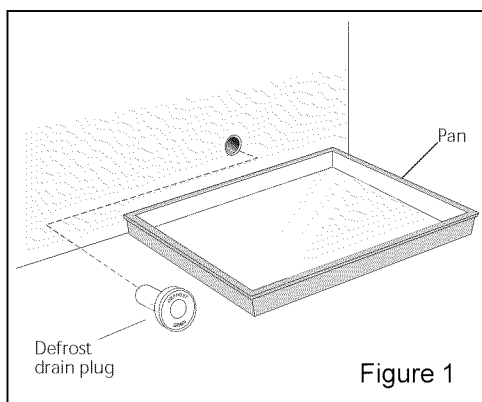

If the frost is soft, remove it by using a plastic scraper. If the frost is glazed and hard, fill deep pans with hot water and place them on the freezer bottom. Close the freezer lid. Frost should soften in about 15 minutes. Repeat this procedure if necessary.

Cleaning

After defrosting, wash inside and outside surfaces of the freezer with a solution of two tablespoons of baking soda in one quart (1.136 litres) warm water. Rinse and dry. Wring excess water out of the sponge or cloth when cleaning in the area of the controls, or any electrical parts.

Wash the removable parts with the baking soda solution mentioned above, or mild detergent and warm water. Rinse and dry. **Never** use metallic scouring pads, brushes, abrasive cleaners, or alkaline solutions on any surface. **DO NOT** wash removable parts in a dishwasher. Replace parts and food.

Power Failure

Do not open freezer door unnecessarily if freezer is off for several hours.

If a power failure occurs, pack seven or eight pounds of dry ice into the freezer every 24 hours. Look in the Yellow Pages under "Dry Ice," "Dairies," or "Ice Cream Manufacturers" for local dry ice suppliers. Always wear gloves and use caution when handling dry ice.

Energy Conservation Measures

The appliance is designed for efficiency with heavy foam insulation. However, there are things that the user can do to maintain the appliance in operating condition:

1. Do not operate the appliance any colder than necessary to maintain safe, product storage temperatures.
2. Make sure the appliance is located to prevent direct exposure to sunlight, air ducts, etc.
3. Keep the lid closed except for normal use. Inspect the lid often to see that it self-closes and the gasket is in good condition.
4. Do not overstock the product in the cabinet because it will block the normal air flow.
5. Have at least annual inspections by a qualified service company to see that the refrigerant charge is correct.
6. This appliance operates more efficiently in a cooler ambient than in a hot ambient. Try to maintain an ambient below 80°F (27°C) and 65% RH for maximum efficiency.

TROUBLESHOOTING GUIDE	Before calling for service, review this list. It may save you time and expense. This list includes common occurrences that are not the result of defective workmanship or materials in this appliance.	
PROBLEM	CAUSE	CORRECTION
FREEZER OPERATION		
Freezer does not run.	<ul style="list-style-type: none"> Freezer is plugged into a circuit that has a ground fault interrupt. Temperature control is in the OFF position. Freezer may not be plugged in, or plug may be loose. House fuse blown or tripped circuit breaker. Power outage. 	<ul style="list-style-type: none"> Use another circuit. If you are unsure about the outlet, have it checked by a certified technician. See Thermostat Settings Section. Ensure plug is tightly pushed into outlet. Check/replace fuse with a 15 amp time-delay fuse. Reset circuit breaker. Check house lights. Call local Electric Company.
Freezer runs too much or too long.	<ul style="list-style-type: none"> Room or outside weather is hot. Freezer has recently been disconnected for a period of time. Large amounts of warm or hot food have been stored recently. Lid is opened too frequently or kept open too long. Temperature Control is set too low. Freezer gasket is dirty, worn, cracked, or poorly fitted. 	<ul style="list-style-type: none"> It's normal for the freezer to work harder under these conditions. It takes 24 hours for the freezer to cool down completely. Warm food will cause freezer to run more until the desired temperature is reached. Warm air entering the freezer causes it to run more. Open the lid less often. Turn control knob to a warmer setting. Allow several hours for the temperature to stabilize. Clean or change gasket. Leaks in the lid seal will cause freezer to run longer in order to maintain desired temperature.
Interior Freezer temperature is too cold.	<ul style="list-style-type: none"> Temperature Control is set too low. 	<ul style="list-style-type: none"> Turn the control to a warmer setting. Allow several hours for the temperature to stabilize.
Interior Freezer temperature is too warm.	<ul style="list-style-type: none"> Temperature Control is set too warm. Lid is opened too frequently or kept open too long. Large amounts of warm or hot food may have been stored recently. Freezer has recently been disconnected for a period of time. 	<ul style="list-style-type: none"> Turn control to a colder setting. Allow several hours for the temperature to stabilize. Warm air enters the freezer every time the lid is opened. Open the lid less often. Wait until the freezer has had a chance to reach its selected temperature. Freezer requires 24 hours to cool down completely.
Freezer external surface temperature is warm.	<ul style="list-style-type: none"> The external freezer walls can be as much as 30°F warmer than room temperature. 	<ul style="list-style-type: none"> This is normal while the compressor works to transfer heat from inside the freezer cabinet.
SOUND AND NOISE		
Louder sound levels whenever freezer is on.	<ul style="list-style-type: none"> Modern freezers have increased storage capacity and more stable temperatures. They require a high efficiency compressor. 	<ul style="list-style-type: none"> This is normal. When the surrounding noise level is low, you might hear the compressor running while it cools the interior.
Longer sound levels when compressor comes on.	<ul style="list-style-type: none"> Freezer operates at higher pressures during the start of the ON cycle. 	<ul style="list-style-type: none"> This is normal. Sound will level off or disappear as freezer continues to run.
Popping or cracking sound when compressor comes on.	<ul style="list-style-type: none"> Metal parts undergo expansion and contraction, as in hot water pipes. 	<ul style="list-style-type: none"> This is normal. Sound will level off or disappear as freezer continues to run.

PROBLEM	CAUSE	CORRECTION
SOUND AND NOISE (Cont.)		
Bubbling or gurgling sound, like water boiling.	<ul style="list-style-type: none"> Refrigerant (used to cool freezer) is circulating throughout the system. 	<ul style="list-style-type: none"> This is normal.
Vibrating or rattling noise.	<ul style="list-style-type: none"> Freezer is not level. It rocks on the floor when it is moved slightly. Floor is uneven or weak. Freezer rocks on floor when it is moved slightly. Freezer is touching the wall. 	<ul style="list-style-type: none"> Level the freezer by putting wood or metal shims under part of the freezer. Ensure floor can adequately support freezer. Level the freezer by putting wood or metal shims under part of the freezer. Relevel the freezer or move freezer slightly.
WATER/MOISTURE/FROST INSIDE FREEZER		
Moisture forms on inside freezer walls.	<ul style="list-style-type: none"> Weather is hot and humid, which increases internal rate of frost build-up. 	<ul style="list-style-type: none"> This is normal.
ODOR IN FREEZER		
Odors in freezer	<ul style="list-style-type: none"> Interior needs to be cleaned. Foods with strong odors are in the freezer. 	<ul style="list-style-type: none"> Clean interior with sponge, warm water, and baking soda. Cover the food tightly.

If You Need Service . . .

Avoid Unnecessary Cost and Inconvenience

Make a few simple checks before calling for service. Common occurrences and their solutions can be found in the "**Troubleshooting Guide**" included in this Owner's Guide.

If Service Is Necessary

Keep your bill of sale, delivery slip, or some other appropriate payment record. The date on the bill establishes the warranty period should service be required. If service is performed, it is in your best interest to obtain and keep all receipts. This written warranty gives you specific legal rights. You may also have other rights that vary from state to state. Service under this warranty must be obtained by contacting your **Arctic Air Customer Service Center**.

In the United States: **800•490•9574**

In Canada: **905•565•9200**

IMPORTANT SAFETY NOTICE

The information provided herein is designed to assist qualified repair personnel only. Untrained persons should not attempt to make repairs due to the possibility of electrical shock. Disconnect the power cord before servicing.

ELECTRICAL CIRCUIT

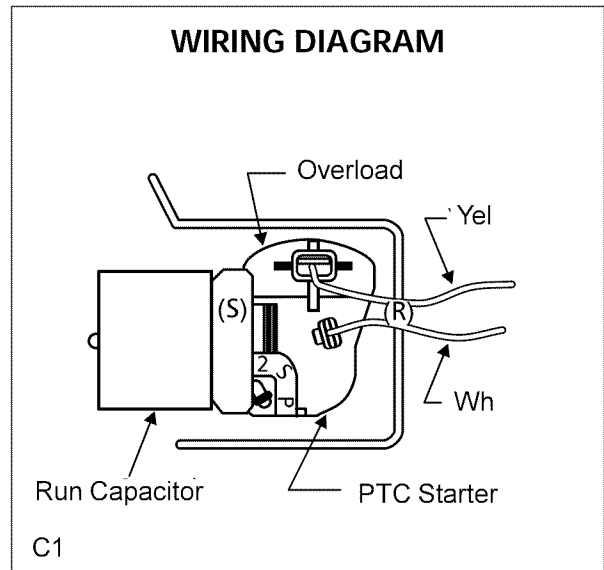
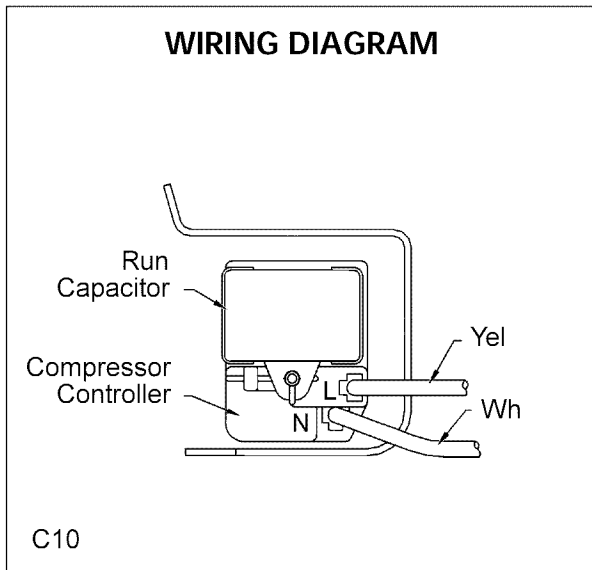
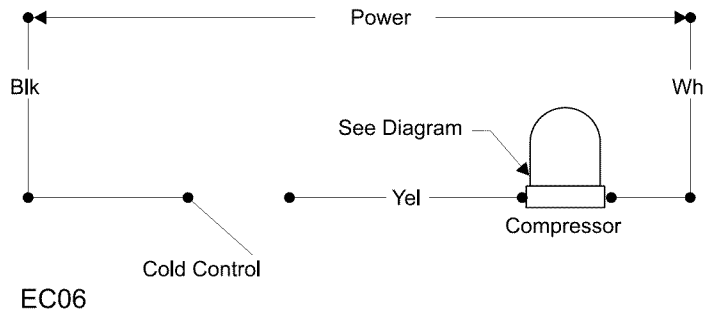

IMPORTANT

If any green grounding wires are removed during servicing, they must be returned to their original position and properly secured.

ARCTIC AIR COMMERCIAL REFRIGERATOR/FREEZER

WARRANTY

ARCTIC AIR (Division of Broich Enterprises, Inc.) warrants every new refrigerator and freezer to be free from defects in material or workmanship for a period of **one (1) year** (except as noted in the Special Mobile Use Warranty below) from the earliest of either: 1) the date of original purchase or; 2) fifteen (15) months after the manufacturer's ship date of the product (warranty period).

This warranty provides:

A. PARTS WARRANTY

ARCTIC AIR will, at its option, repair or replace any part(s), that are found defective during the warranty period. In addition, **ARCTIC AIR** warrants that the **compressor** shall be free from defects for an additional **four (4) years** beyond the expiration of the warranty period or for a total period of **five (5) years**.

Warranty replacement parts must be arranged by calling the **Customer Service Center** at **1-800-490-9574** (in the United States and Puerto Rico) and **1-905-565-9200** (in Canada).

B. LABOR WARRANTY

ARCTIC AIR will, at its option, provide or pay for the labor to repair or replace the part(s) or product defect during the warranty period. Warranty labor must be arranged by calling the **Customer Service Center** at **1-800-490-9574** (in the United States and Puerto Rico) and **1-905-565-9200** (in Canada).

C. SPECIAL MOBILE USE WARRANTY

ARCTIC AIR warrants every new refrigerator and freezer operated by a concessionaire or vendor in a trailer, motorized vehicle or at varying locations for a period of **one (1) year** for the part(s) and **ninety (90) days** for labor to repair or replace, at **Arctic Air's** option, the warranty part(s). In addition, **ARCTIC AIR** warrants that the **compressor** shall be free from defects for a total period of **five (5) years**. This warranty will be effective with the earliest of either: 1) the date of original purchase or ; 2) fifteen (15) months after the manufacturer's ship date of the product. Any labor to remove or expose or make the refrigerator or freezer available for service under this warranty shall be at the user's expense.

D. CONDITIONS

Service under this warranty must be performed by a preferred service company arranged by the **Customer Service Center** at **1-800-490-9574** (in the United States and Puerto Rico) and **1-905-565-9200** (in Canada). The user must give the preferred service company prompt notice and access to the product when service is needed.

E. LIMITATIONS AND EXCLUSIVE WARRANTY

Normal wear and tear and gradual deterioration is excluded from this warranty. This parts and labor warranty is the sole and exclusive warranty remedy offered by **ARCTIC AIR**. **ALL OTHER WARRANTIES, EITHER EXPRESS OR IMPLIED, ARISING UNDER LAW OR EQUITY OR CUSTOM OF THE TRADE INCLUDING BUT NOT LIMITED TO WARRANTIES OR MERCHANTABILITY OR FITNESS FOR A PARTICULAR PURPOSE ARE EXCLUDED. NEITHER ARCTIC AIR NOR ITS SERVICING AGENT SHALL BE LIABLE FOR ANY INCIDENTAL OR CONSEQUENTIAL LOSS OR DAMAGES (INCLUDING BUT NOT LIMITED TO FOOD OR PRODUCT LOSS, PERSONAL INJURY OR PROPERTY DAMAGE) WHETHER BASED ON CONTRACT OR TORT (INCLUDING NEGLIGENCE AND STRICT LIABILITY) ARISING OUT OF THE EQUIPMENT OR SERVICE PROVIDED HEREUNDER. THIS WARRANTY DOES NOT APPLY TO ARCTIC AIR PRODUCTS SOLD OUTSIDE THE UNITED STATES, CANADA, OR PUERTO RICO. THIS WARRANTY DOES NOT COVER:**

- **FREIGHT DAMAGE**
- **FOOD LOSS**
- **NON-FACTORY APPROVED REVISIONS OR MODIFICATIONS**