

UNDER-BENCH RV HEAT PUMP AIR CONDITIONER

PIONEER®

MODEL NO: PYR009AZUDCIPD

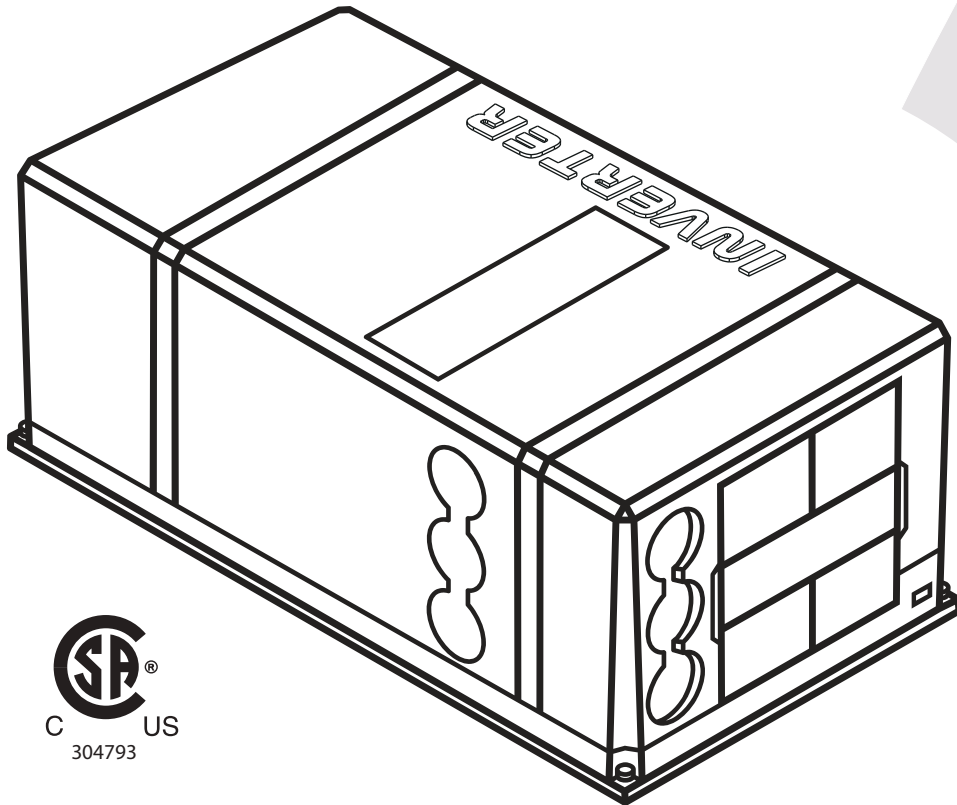

Owner's Manual

- Installation
- Operation
- Maintenance

IMPORTANT NOTICE:

Please read this manual carefully before installing or operating your new air conditioning system. Be sure to save this manual for future reference.

 **Wireless
Internet
Ready**
FCC IDENTIFIER:2ANDL-CB3S



REV082624

INSTRUCTIONAL HANDBOOK

Table of Contents

I. Operational Instructions.....1

1. Safety Information.....	1
2. Scope and Purpose of This Manual.....	2
3. Model Number and Technical Details Identification.....	2
4. Description and Illustration of the Machine.....	3
5. Best Practices for Optimal Performance.....	4
6. Warning and Safety Precautions for A2L Refrigerant.....	4
7. Description of the Controls.....	5
8. Automatic Mode Operation.....	6
9. Cooling Mode Operation.....	6
10. Dehumidification Mode Operation.....	7
11. Ventilation Mode Operation.....	7
12. Heat Pump Mode Operation.....	8
13. Night Mode Operation.....	8
14. Timer On and Timer Off Mode Operation.....	9
15. Handling of the Remote Controller.....	10
16. Description of the Wall Controller.....	10
17. Routine Maintenance.....	11

II. Installation Information.....12

1. Technical Specifications.....	12
2. Getting Started	13
3. Selecting the Location of Installation.....	14
4. Preparation of Floor Openings and Unit Fastening.....	15
5. Securing the System to the Floor.....	16
6. Fastening the System Into Place.....	17
7. Placement of the Wall Thermostat.....	18
8. Recirculation Air Compartment Opening.....	19
9. Air Ducting.....	19
10. Electrical Hookup.....	20
11. Simplified Wiring Diagram.....	20
12. Wireless Internet Pairing Process.....	21

III. Troubleshooting, Maintenance, Recycling.....23

1. Troubleshooting and Diagnosis.....	23
2. Error Codes List.....	24
3. Exploded Parts Diagram.....	25
4. European Disposal Guidelines.....	26

OPERATIONAL INSTRUCTIONS

Safety Information

⚠ CAUTION - Read Before You Proceed

Read and Understand All Safety Precautions Prior to Installation

For safe operation, it is imperative that the following rules are obeyed:

- This appliance can only be used by children aged 8 years and above, or by persons with reduced physical, sensory, or mental capabilities, or persons with lack of experience and knowledge, if they have been given supervision or instructions concerning usage of the appliance in a safe way and understand the potential hazards involved.
- Children shall not play with this appliance. Proper cleaning and user maintenance shall not be done by children without supervision.
- If supply cord is damaged, it must be replaced by the manufacturer, a certified service agent, or other qualified persons to avoid hazard.
- The appliance shall have a full disconnect switch in the hardwire configuration in accordance with the national electrical standards.

Electrical Danger

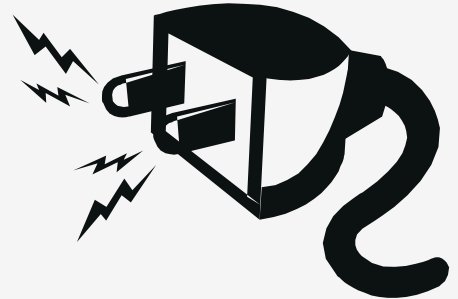

Failure to abide by the manufacturer cautions can result in property damage, personal injury and/or death.

⚠ WARNING - The Manufacturer Is Not Liable For the Following:

- Units that have sustained damage due to improper installation or have been connected with an incorrect voltage. Abide by the installation instructions fully and completely to prevent unexpected malfunctions.
- Products that have had extra modifications, where written consent was not provided by the manufacturer.
- Product usage in a way that is not the intended purpose as described in this operational instruction manual.
- Any sort of collateral damage to property or injuring to nearby persons caused by failure of the product.
- Improperly grounded products. The product must be properly grounded at the time of installation, else electrical shock may occur.
- Incorrect configuration of drainage. Install drainage channels according to the instructions in this manual. Improper drainage may cause water damage to your vehicle and property.

🔧 Note about Fluorinated Gasses and Operation of the System

1. This air-conditioning unit contains fluorinated gasses. For specific information on the type of gas and the amount, please refer to the relevant label on the unit itself. Some refrigerants may not exude an odor.
2. Installation, service, maintenance, and repair of this unit must be performed by a certified HVAC technician, or qualified personnel familiar with the risks of handling refrigerant and regulations of air conditioner systems.
3. Product uninstallation and recycling must be performed by a certified HVAC technician.
4. Do not use the system near combustible objects or flammable fluids. Keep a distance of at least 2 feet from other nearby appliances. If a fire occurs, a proper extinguishing agent, rather than water, must be used.
5. When the unit is being checked for leaks, proper logging and record-keeping of all checks by certified personnel is strongly recommended. Refrigerant must never be released into the air, a proper recovery device should be used.
6. The system and/or its internal moving parts should not be touched, poked, or prodded during operation.



OPERATIONAL INSTRUCTIONS

Scope and Purpose of This Manual

This manual has been specifically compiled by the manufacturer and is an essential component of the machine. The information contained within can guarantee proper usage of the machine, if observed and followed carefully.

Sections **I** and **III** are intended to provide helpful instructions and knowledge to the end user. Section **II** is intended to instruct the installer, who should be a person that possesses expert knowledge and experience in this field of work.

Where applicable, some portions of text may be accompanied by certain symbols, that of which can be understood by referencing the below table:

-  This symbol indicates a potential source of danger.
-  This symbol indicates useful information or a helpful tip.
-  This symbol indicates information on being environmentally friendly.

Model Number and Technical Details Identification

Interpreting the Rating Label:



Technical Specifications

Model Number

PIONEER		Under-Bench Air Conditioner	
Model:		Global Warming Potential:	675
Power :	115V/60Hz	Refrigerant :	R32
Cooling Capacity :	10000Btu/h	Charge :	390 g/13.75 oz
Heating Capacity :	9500Btu/h	Waterproof(For final installation):	IPX5
Max current for Cooling :	8.6A	Maximum allowable Pressure(High Side):	6 MPa/870 PSIG
Max current for Heating :	6.9A	Weight:	57.6 lbs
Rated input current of the power conversion Equipment:	8.6A	Dimensions(LxWxH):	28.9x15.95x11.65 inch
Indoor Fan Motor:	1/8HP		
PARKER DAVIS HVAC INTERNATIONAL Miami, FL - www.pdhvac.com - (800)-675-7410		Date of Manufacture: See barcode MADE IN CHINA	



Supplier Information

OPERATIONAL INSTRUCTIONS

Description and Illustration of the Machine

The purpose of this machine is to provide greater control of the air temperature within the vehicle that it is installed (such as motor homes, caravans, recreational vehicles, etc.). When the ambient outdoor temperature is hot and humid, it can supply the vehicle with cool and dehumidified air via the refrigeration cycle.

It can also run this process in reverse, to supply heated air into the vehicle, whether as a supplement, or replacement for the vehicle's original heating system. In both instances, the setting of the desired air temperature is configurable by the user.

The system is composed of: (A) Compressor, (B) Condenser, (D) Evaporator, (F) 4-Way Valve and Pressurized Refrigerant R32.

❶ Cooling Mode - Description of Operation

By changing physical state from liquid to gas, the refrigerant heats or cools the components through which it passes. The air that is drawn into the system (the "return air") by the fan blower (C) flows through the evaporator which has been made significantly cold. The air then comes out cooled and removed of humidity (the "supply air").

This process repeated continuously over a long period of time leads to a reduction in the air temperature and humidity levels inside the vehicle.

❷ Heating Mode - Description of Operation

The method of heating is quite similar to that of cooling, however the process occurs in reverse.

The refrigeration cycle is reversed by the 4-way valve switching over (F). The internal coil becomes the condenser rather than the evaporator, thereby heating the air that passes through it.

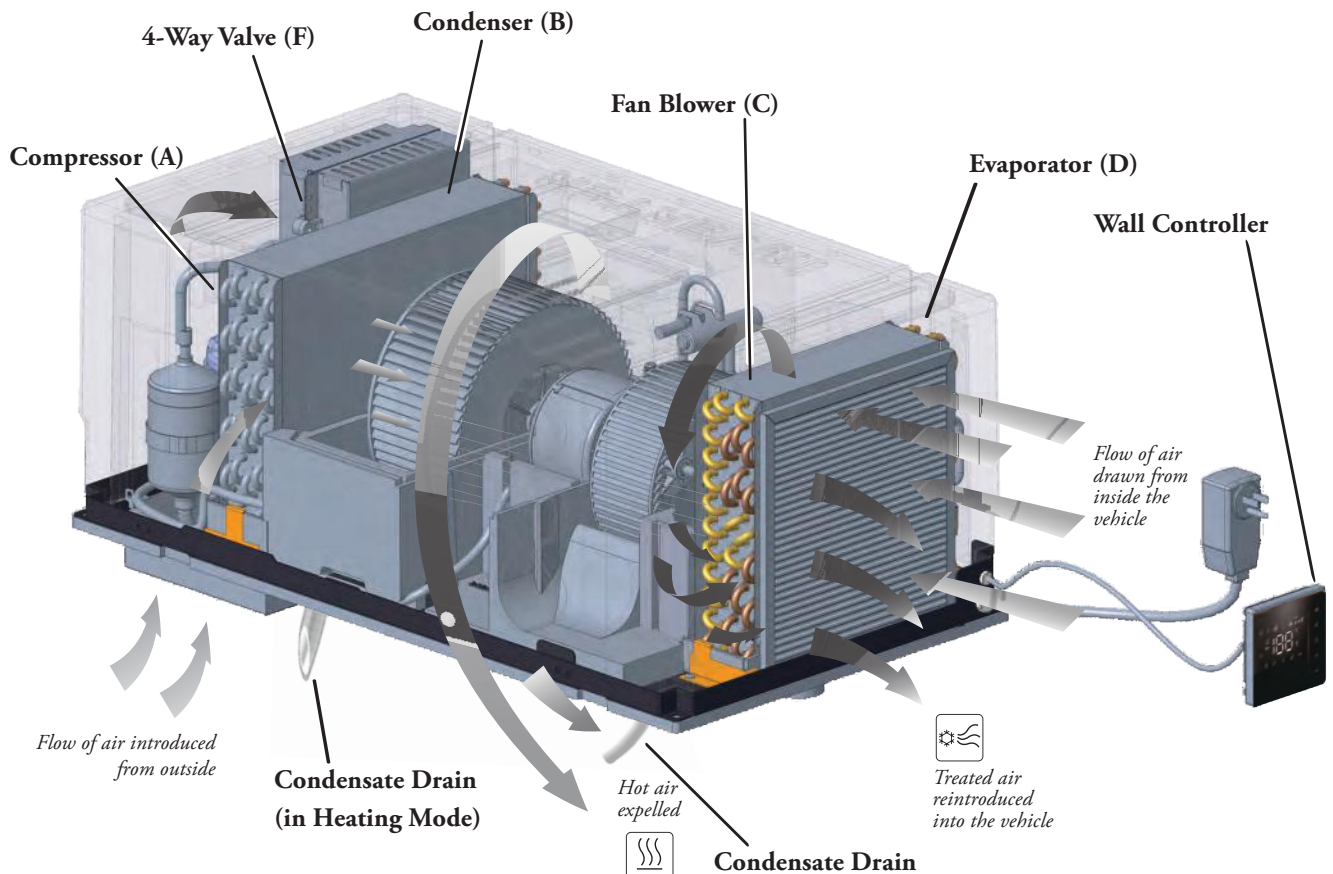

This process takes more standby time as the internal coil spends a few minutes heating up to begin working, in addition to periodic defrost cycles from the machine.









OPERATIONAL INSTRUCTIONS

Best Practices for Optimal Performance

 *For best results, the following tips are given in order to improve the output and efficiency of the machine:*

-  Increase the vehicle's insulation amount by sealing off openings and covering glass surfaces with reflective or blackout curtains.
-  When running the machine, select the desired temperature and fan speed and ensure that the air vents are oriented in a suitable and proper direction.
-  Avoid the frequent opening of doors and/or windows when not necessary.

 *To prevent mechanical malfunctions and minimize risk of personal injury, ensure that the following precautions are abided by:*

-  Avoid obstruction of the ventiled air inlet. Do not cover with cloth, paper, etc.
-  Do not put hands or insert fingers into any of the machine's openings.
-  Do not spray water into or onto the surface of the machine.
-  Keep flammable substances and objects 3 feet or more away from the machine.
-  Clean the machine's air filters periodically.

Warnings and Safety Precautions for A2L Refrigerant



This appliance uses A2L refrigerant, which is classified as mildly flammable. It is critical to follow these safety precautions to minimize the risk of fire or explosion.

Handling and Installation:

- Only qualified personnel should handle A2L refrigerant. Improper handling can cause injury or damage.
- Before servicing, check for ignition sources and ensure proper ventilation. Use a suitable leak detector to confirm the area is safe.
- Ensure all electrical components are rated for A2L refrigerant and avoid any sources of ignition during installation or service.
- When charging the system, ensure proper grounding and secure connections. Avoid overfilling the system.

Leak Detection and Repair:

- If a leak is suspected, do not use open flames or spark-generating tools. Use appropriate electronic leak detectors.
- Evacuate and ventilate the area immediately if a leak is found. Repair leaks only when the area is safe.
- Keep a fire extinguisher rated for flammable materials nearby when working with A2L refrigerants.

Decommissioning and Disposal:

- Recover all refrigerant and purge the system with inert gas before disassembly.
- Dispose of refrigerant according to regulations and do not vent it into the atmosphere.
- Clearly label equipment containing A2L refrigerant and ensure all safety information is visible.

Adhering to these guidelines ensures safe handling and use of A2L refrigerant, preventing injury, damage, or environmental harm.

OPERATIONAL INSTRUCTIONS

Description of the Controls

📍 Selecting the Functional Mode:

Press the **MODE** button to cycle between the available states on the machine. After two seconds have elapsed, the system will confirm the selection with an audible beep from the machine's speaker. Always point the remote controller toward the wall pad when sending commands to ensure the best reception.

NOTE: When first switching on the system, the machine will stay in standby mode for a few minutes before the compressor begins operating.

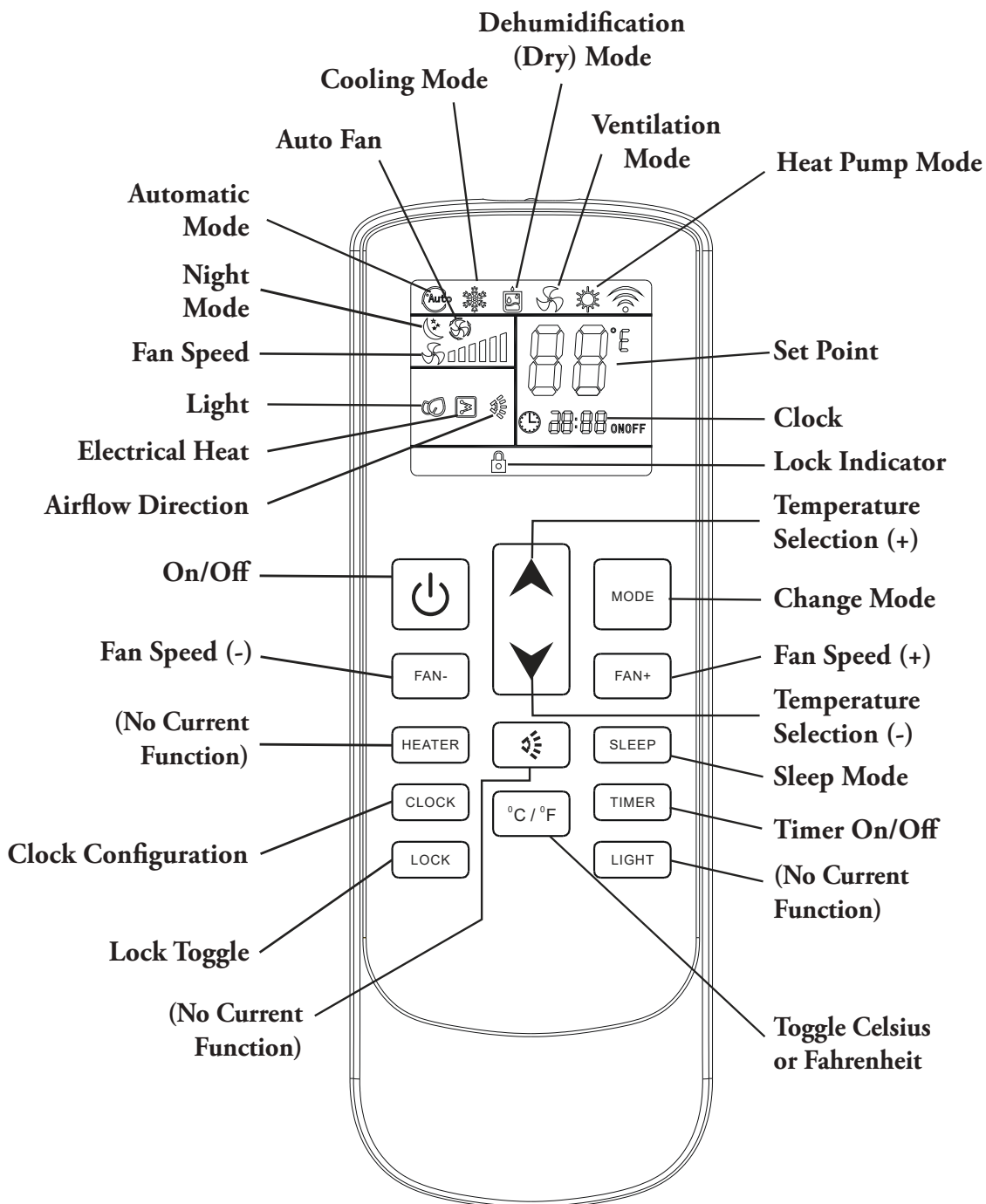

OPERATIONAL INSTRUCTIONS





Automatic Mode Operation

In **AUTO** mode, the system manages the compressor, heat pump, and fan speeds entirely autonomously by comparing the set temperature with the current internal temperature as given in the following table:

Internal Temperature	$T \leq 68^{\circ}\text{F}$	$68^{\circ}\text{F} < T < 77^{\circ}\text{F}$	$T \geq 77^{\circ}\text{F}$
Operating Mode	Heating, Ventilation	Dehumidification, Ventilation	Cooling
Set Point	68°F	72°F	77°F

On the **AUTO** speed setting the ventilation speed is set according to the difference in temperature between the set point and the current ambient temperature.

Automatic Mode Button Control:

	Press the On/Off button to switch the machine on or off
	Press the Change Mode button to select AUTO mode
	The temperature selection buttons are disabled in this mode
	Press the fan speed buttons to select low, medium, high, or automatic fan speed

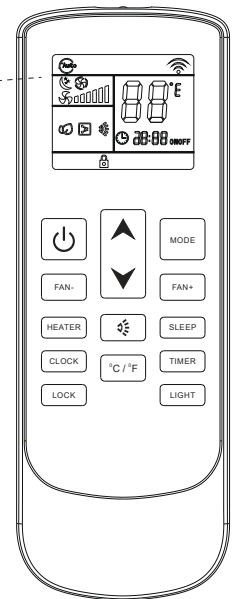
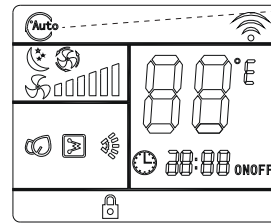





 Set temperature is selected based on the conditions given in the set point table on this page.

 The selected configuration will be retained in the system's memory when it is switched on again next.

Cooling Mode Operation

Cooling Mode Button Control:

See page 3 for an explanation of Cooling Mode functionality.

	Press the On/Off button to switch the machine on or off
	Press the Change Mode button to select COOL mode
	Use the temperature selection buttons to select a set point between 64 and 86°F.
	Press the fan speed button to select low, medium, high, or automatic fan speed

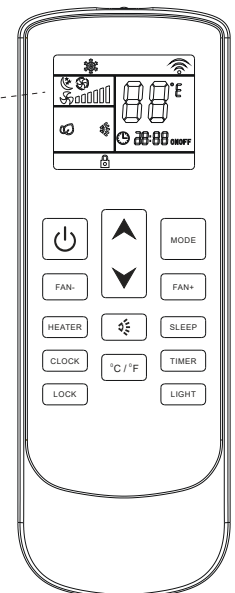
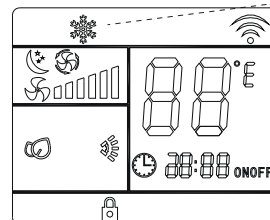





 The selected configuration will be retained in the system's memory when it is switched on again next.

OPERATIONAL INSTRUCTIONS

Dehumidification Mode Operation

Dehumidification Mode Button Control:

Dehumidification mode is a limited function that can help reduce the humidity/moisture of the room. However, this system is not intended for use as a dedicated dehumidifier and so this mode should not be left running for very long periods of time.

	Press the On/Off button to switch the machine on or off
	Press the Change Mode button to select DEHUMIDIFICATION mode
	Use the temperature selection buttons to select a set point between 64 and 86°F.
	Fan speed selection button is disabled in this mode.

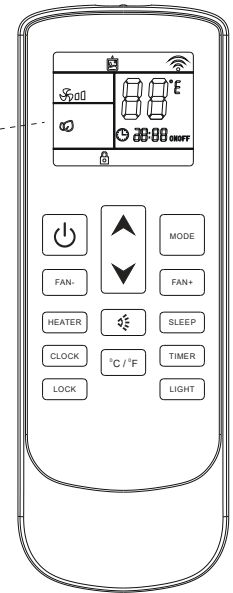
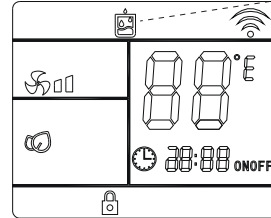





The selected configuration will be retained in the system's memory when it is switched on again next.

Ventilation Mode Operation

Ventilation Mode Button Control:

Fan-only mode is used to set the system to use only air ventilation and no heating or cooling.

	Press the On/Off button to switch the machine on or off
	Press the Change Mode button to select VENTILATION mode
	Use the temperature selection buttons to select a set point between 64 and 86°F.
	Press the fan speed button to select low, medium, high, or automatic fan speed

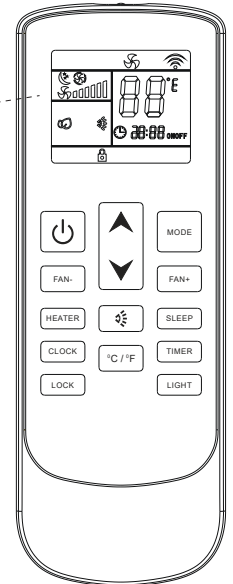
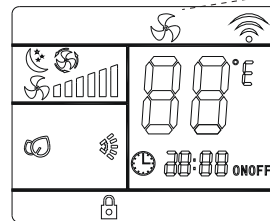





The selected configuration will be retained in the system's memory when it is switched on again next.

OPERATIONAL INSTRUCTIONS

Heat Pump Mode

ⓘ Heating Mode Button Control:

See page 3 for an explanation of Heating Mode functionality.

	Press the On/Off button to switch the machine on or off
	Press the Change Mode button to select HEAT PUMP mode
	Use the temperature selection buttons to select a set point between 64 and 86°F
	Press the fan speed button to select low, medium, high, or automatic speed

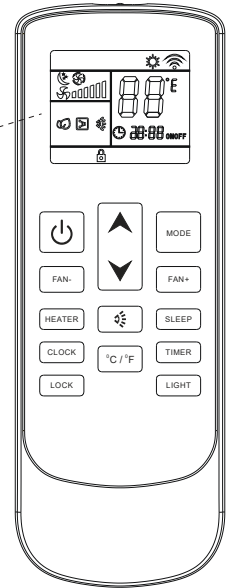
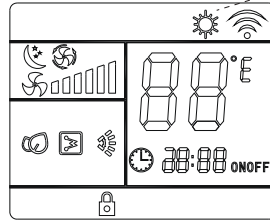





☞ *The selected configuration will be retained in the system's memory when it is switched on again next.*

Night Mode Operation

ⓘ Night Mode Button Control:

Night mode is generally meant for periods of lower cooling requirements, such as during typical sleeping hours. This mode will result in decreased energy use, and can only be activated via remote control.

	Press the On/Off button to switch the machine on or off
	Press the Change Mode button to select the desired operation mode
	Press the night mode button to turn this feature on or off
	Use the temperature selection buttons to select a set point between 64 and 86°F.
	The system automatically keeps the fan speed to low when using this mode

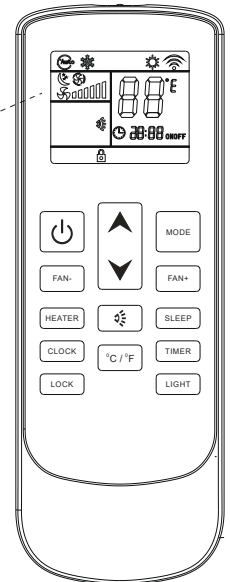
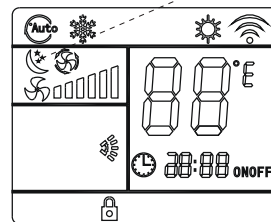









☞ *The selected configuration will be retained in the system's memory when it is switched on again next.*

☞ *This mode sets the ventilation on low speed therefore it is not possible to switch to the other available options.*

OPERATIONAL INSTRUCTIONS

Timer On and Timer Off Mode Operation



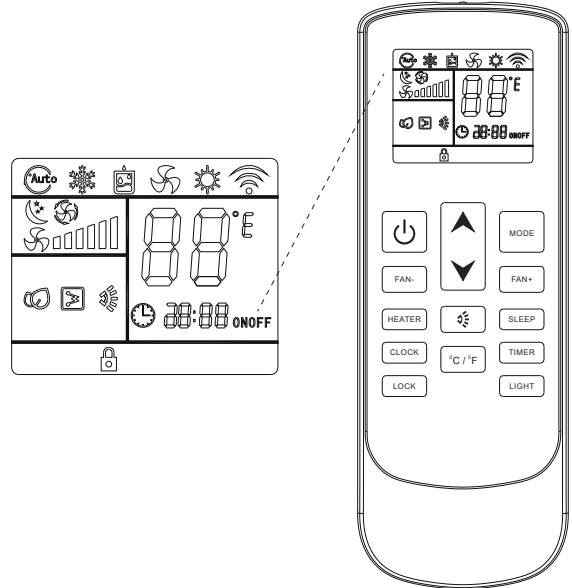

How to Configure the Timer Off Feature:

	Press the On/Off button to switch the machine on
	Press the Change Mode button to select the desired operation mode
	Use the temperature selection buttons to select a set point between 64 and 86°F.
	Press the fan speed button to select low, medium, high, or automatic fan speed
	Press the Timer button to set the time at which the system turns itself off
	Use the temperature selection buttons to modify the time value selection
	Press the Timer button to confirm the selections entered
	Pressing the Timer button once more will deactivate the feature



When the Timer Off button is first pressed, the symbol on the display will be flashing to signify the switch-off feature is being set. Pressing it once more will confirm the data entered, and the icon will remain solid to indicate that Timer Off is set. Pressing it a third time deactivates the Timer Off function.

How to Configure the Timer On Feature:

	The system must currently be off to configure the Timer On function
	Press the Timer button to set the time at which the system will come on
	Use the temperature selection buttons to modify the time value selection
	Press the Timer button once more to confirm the selections entered
	Pressing the Timer button for a third time will deactivate the feature

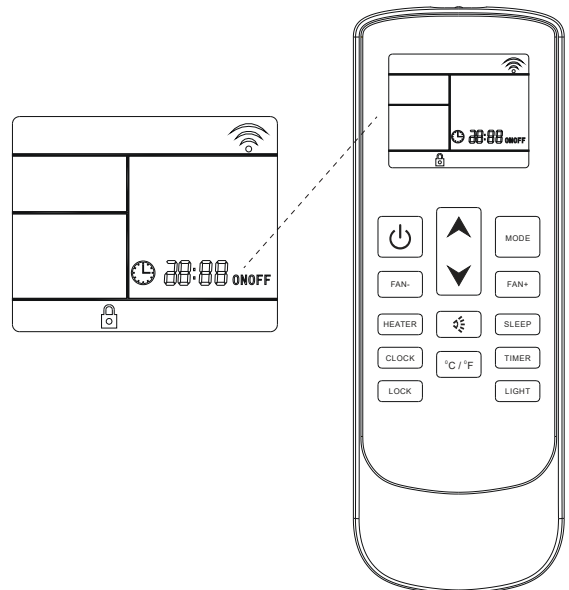

When the Timer button is first pressed, the symbol on the display will be flashing to signify the switch-off feature is being set. Pressing it once more will confirm the data entered, and the icon will remain solid to indicate that Timer Off is set. Pressing it a third time deactivates the Timer Off function.

The system starts in AUTO mode at time of Timer On activation.

OPERATIONAL INSTRUCTIONS

Handling the Remote Controller

📌 Installing/Changing the Remote Controller Batteries:

1. Remove the rear battery cover
2. If there are already batteries installed, remove them and insert two fresh AAA size batteries, ensuring to pay attention to the direction of their polarities (+/-).
3. Slide the rear battery cover of the remote back into place.
4. Check that the remote works properly by pressing the ON button. If on pressing the ON button no icon appears on the display, re-install the batteries and confirm that they are new and have been placed in the correct orientation
5. The system is now ready to be controlled.

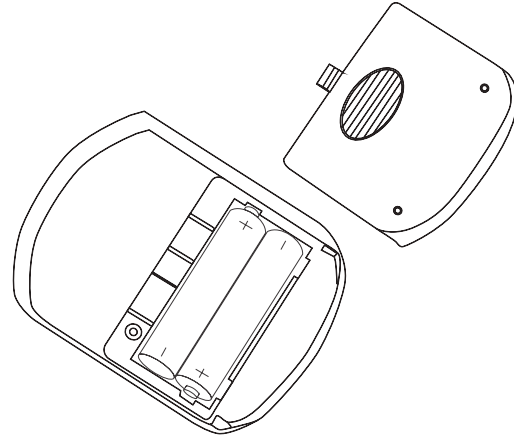

Description of the Wall Controller

📌 Introduction to the Wall Controller Buttons:

1. **MODE Button** - Use this button change the operating modes of the system.
2. **FAN Button** - Use this button to select the desired fan speed (auto/high/med/low).
3. **ON/OFF Button** - Use this button to switch the system On or Off. It will start using the memory of the previous settings.
4. **Up/Down Buttons** - Use these two buttons to configure the desired temperature.
5. **Functional LED Display** - This will tell you the current set point temperature setting.

After 10 seconds have elapsed, this will begin showing the current room temperature. Once 1 minute has elapsed, the display will turn off.
6. **Child Lock Button (Up/Down)**- Press and hold the up/down keys to open the child lock state. The system will then block any input.
7. **Wireless Internet Connection** (down button when Off) - Press and hold the Down key with the system off to enter pairing mode.

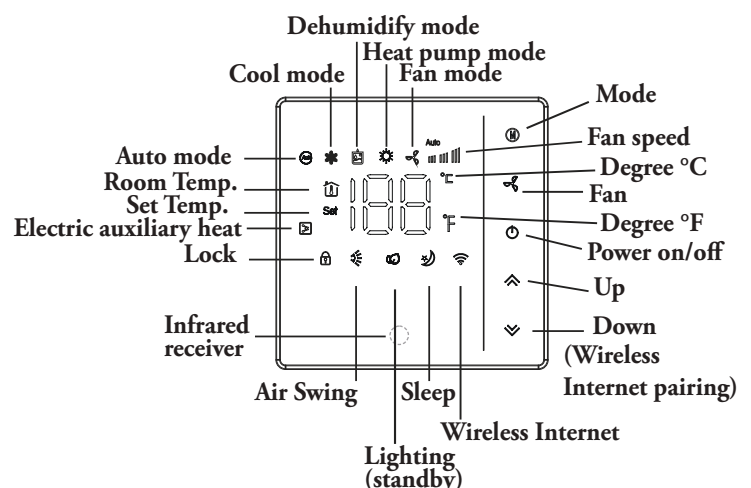

OPERATIONAL INSTRUCTIONS

Routine Maintenance

📍 Periodic Cleaning Methods:

Using a soft and moist cloth, wipe down the surface area of the machine periodically in order to remove dust. Use clean water or a non-aggressive detergent if necessary. Do not use petrol or solvents to clean the machine. Repeat this process every season.

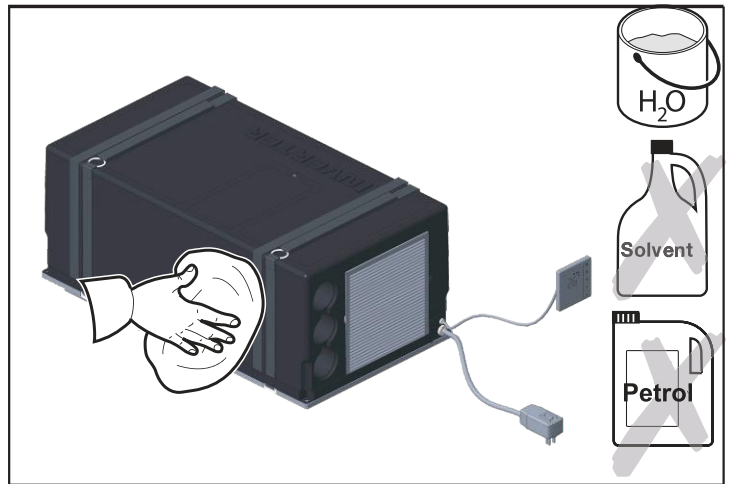

Remove the air filters and wash gently by hand with a detergent solution, allowing it to dry before inserting back into place. Repeat this process every 30-45 days.

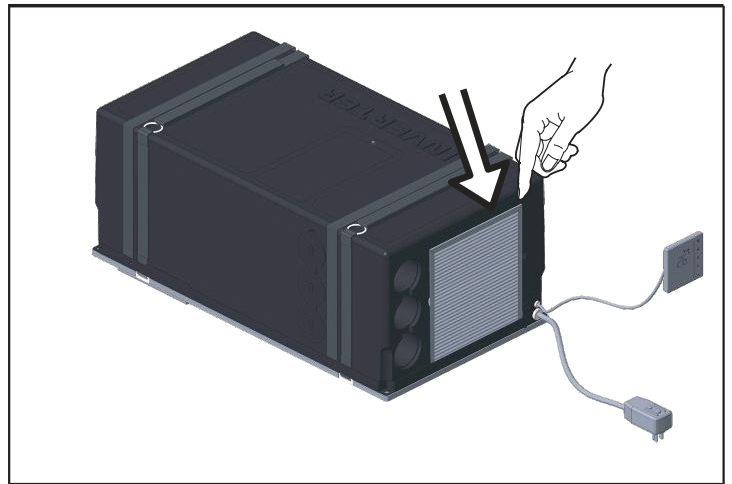

If an optional active carbon filter is installed, it is advised to replace them yearly.

📍 Checking Best Practices:

Periodically inspect the system, particularly the points of drainage, as well as the air intake points.

Ensure that the system is able to drain successfully. If there are any sort of clogs, clear the blockage before continuing to operate the system.

Confirm that there are no obstructions in the floor openings. For best performance, it is important that the condenser-side return air can enter and exit the system without any restrictions.

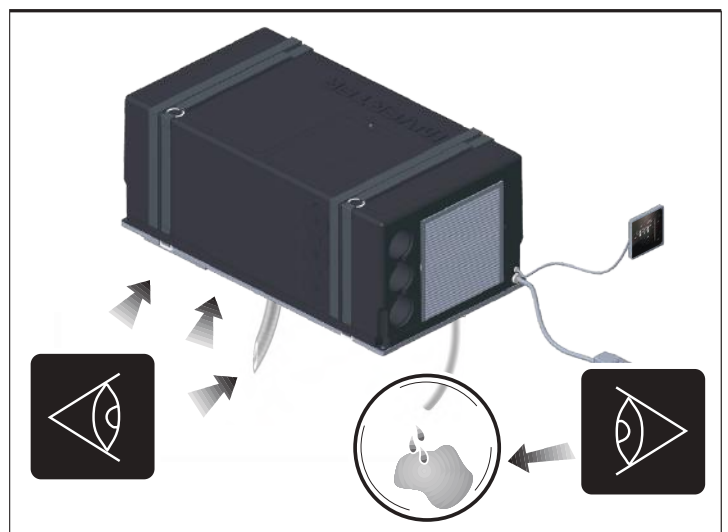

INSTALLATION INSTRUCTIONS

Technical Specifications

*All measurements in inches

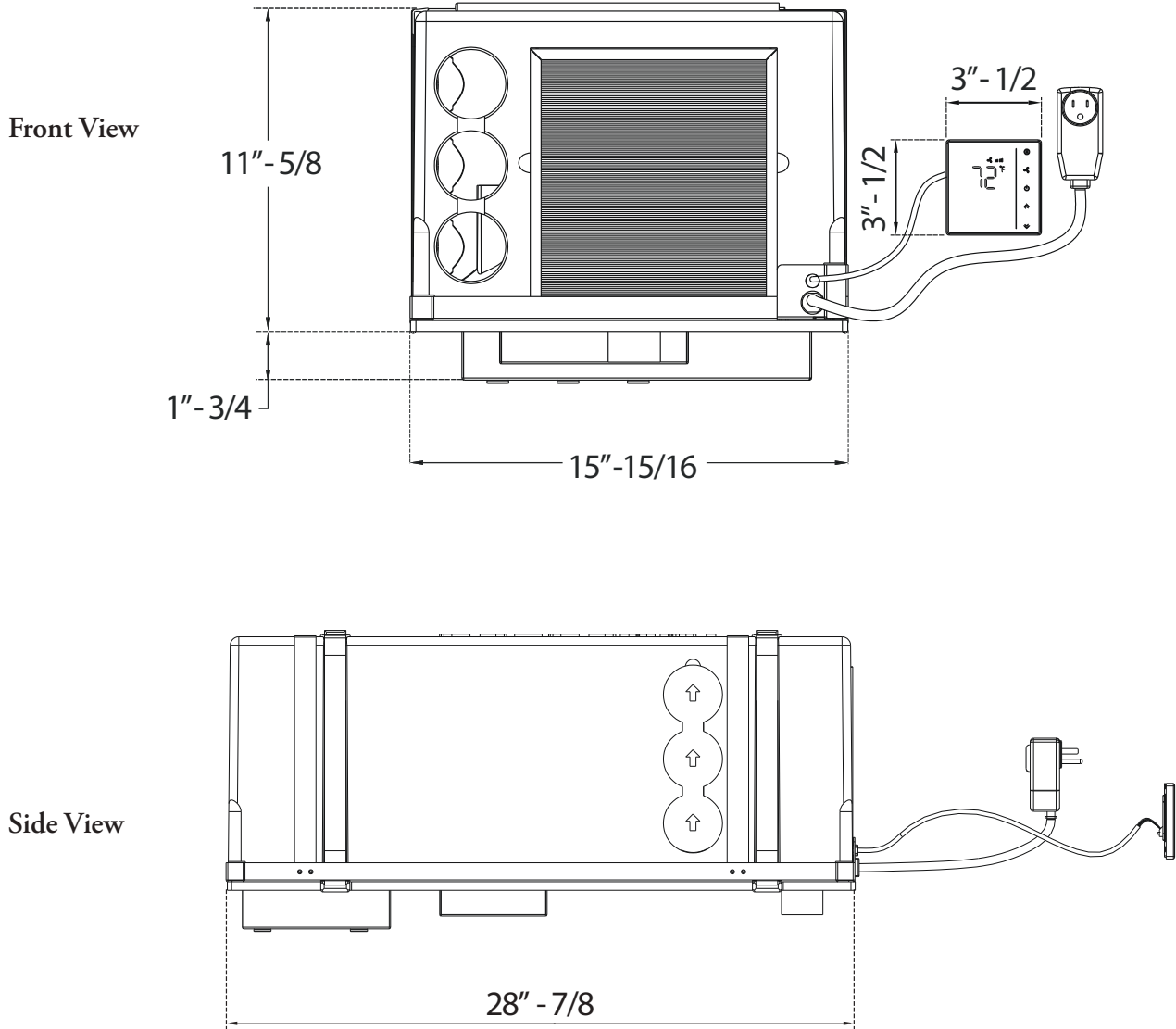

Description	Unit of Measurement	Model Number
		PYR009AZUDCIPD
Refrigerant Type/Amount	See System Nameplate	
Cooling Capacity	BTU/hour	10000
Heating Capacity	BTU/hour	9500
Maximum Cooling Operational Consumption	Amps	8.6
Maximum Heating Operational Consumption	Amps	6.9
Breakaway Current	Amps	20 (150ms)
Additional Heating Element	Watts	/
Electricity Supply	Volts - Hertz	115 - 60
Protection Class	IP	X5
Maximum Treated Air Volume	CFM	206
Maximum Volume (Recommended with Insulated Walls)	ft ³	1060
Weight	lbs	57.6
Ventilation	Speed No.	3
Global Warming Potential	GWP	675
Cooling Operating Temperature	Outdoor/Indoor	from 63°F to 109°F/from 63°F to 90°F
Heating Operating Temperature	Outdoor/Indoor	from 28°F to 75°F/from 28°F to 81°F

INSTALLATION INSTRUCTIONS

Getting Started

Installation should only be performed by those with sufficient technical knowledge. In addition, the proper tools and equipment should be used for the installation process, to ensure the safety of themselves and those nearby.

ⓘ Unpacking and Handling the System:

Observe and follow any special instructions or warnings present on the outer packaging before attempting to handle the system.

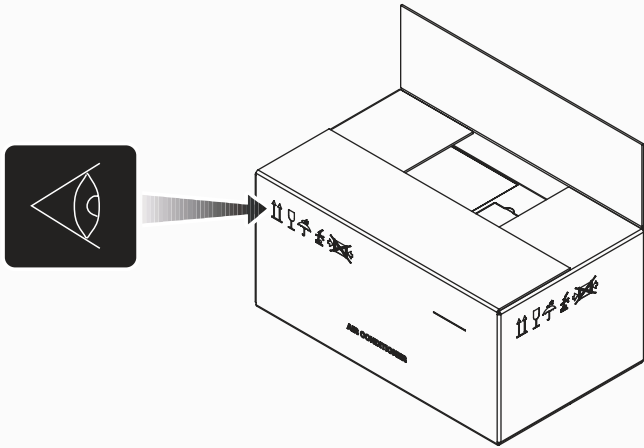

Using equal force on both sides, lift the machine out of the box.

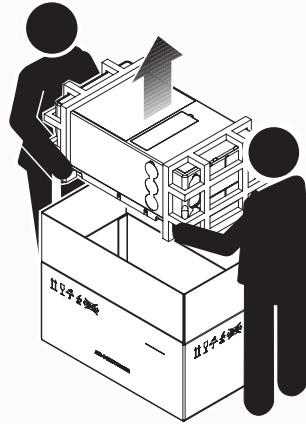

Lift the machine by using only the handles or the belts on the base.

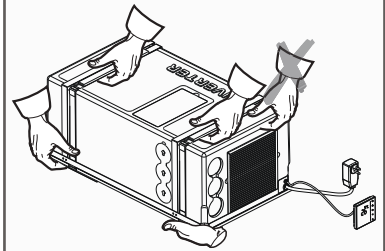

When resting the system on a surface, assure to distribute the weight of the machine by supporting it on both sides equally.

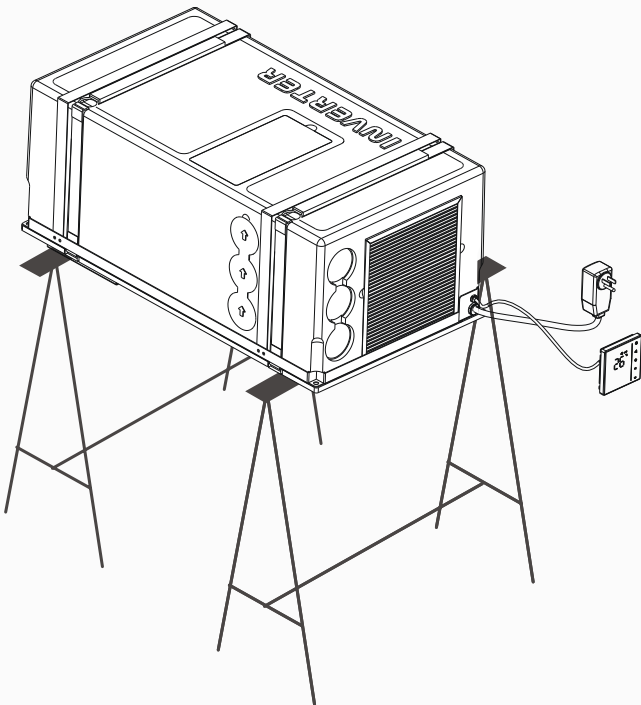



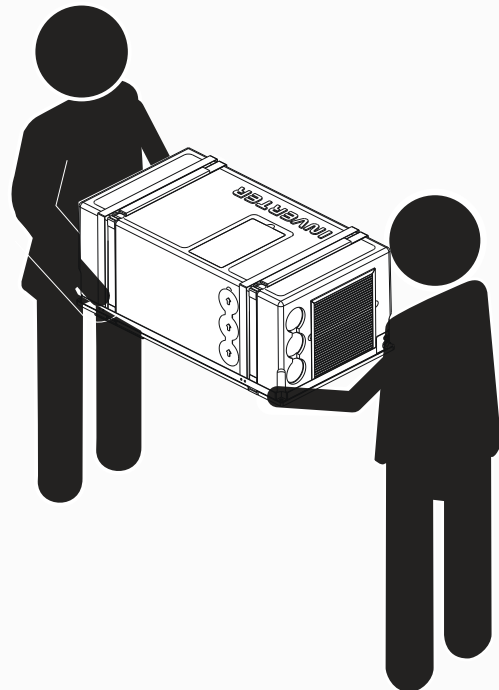



Seek the help of an additional person to assist in transferring the system to the final place of installation, being sure to do so slowly and carefully.





INSTALLATION INSTRUCTIONS

Selecting the Location of Installation

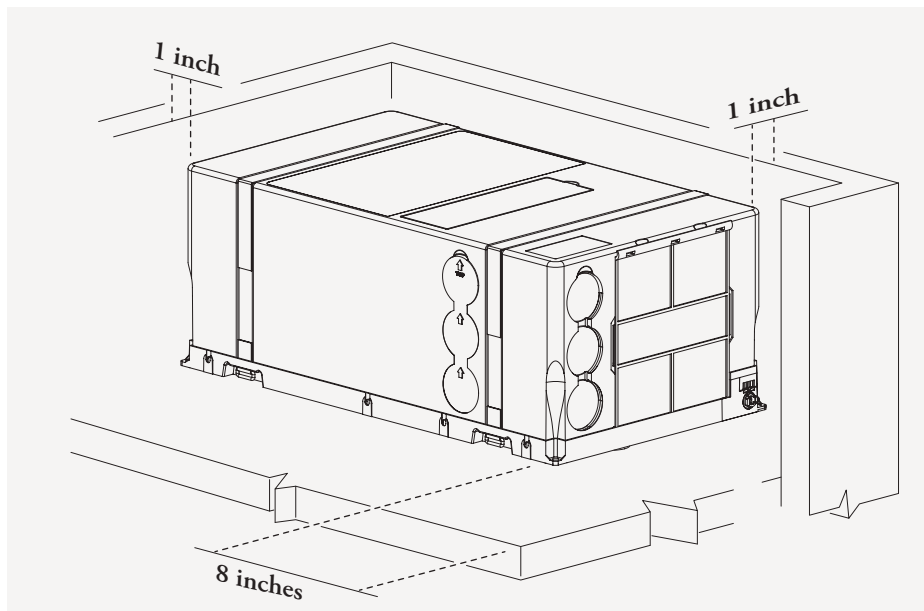
-  *In order for the machine to properly provide uniform climate control in the vehicle, it should be installed as close to the center as possible, inside a housing/compartment.*
-  Position the machine so as to ensure ease of access, and facilitation of both installation and disassembly.
-  Place the template used for assembly within the compartment intended for installation and verify the available space for the needed openings in the floor.
-  Avoid the frequent opening of doors and/or windows when not necessary.
-  *In order to minimize transmission of noise and/or vibration during operation, the machine must have a minimum clearance of 1 inch away from walls and fittings on either side.*
-  The machine must be installed on the floor, and as horizontally level as possible.
-  To allow for ease of filter replacement, keep a distance of 8 inches from the front of the machine and the interior wall of the compartment.



-  If incorporating any external compartments (such as false bottoms), the air that is to be treated must be drawn in from the vehicle's passenger compartment.
-  Drawing in air from outside can negatively impact the performance of the system significantly.

INSTALLATION INSTRUCTIONS

Preparation of Floor Openings and Unit Fastening

ⓘ Clearances and Procedure for Securing the System:

Installation of the machine involves creating openings in the floor. These openings must not be covered or obstructed by parts of the chassis frame or similar fixtures. It is also important to block the openings from splashes coming from the wheels, using a splash guard or something similar if necessary.

Take special care to ensure a gap of at least 1 inch is left between the machine and its adjacent walls. Use the provided kit to secure the machine to the interior floor.

Bottom View

**All measurements
in inches*

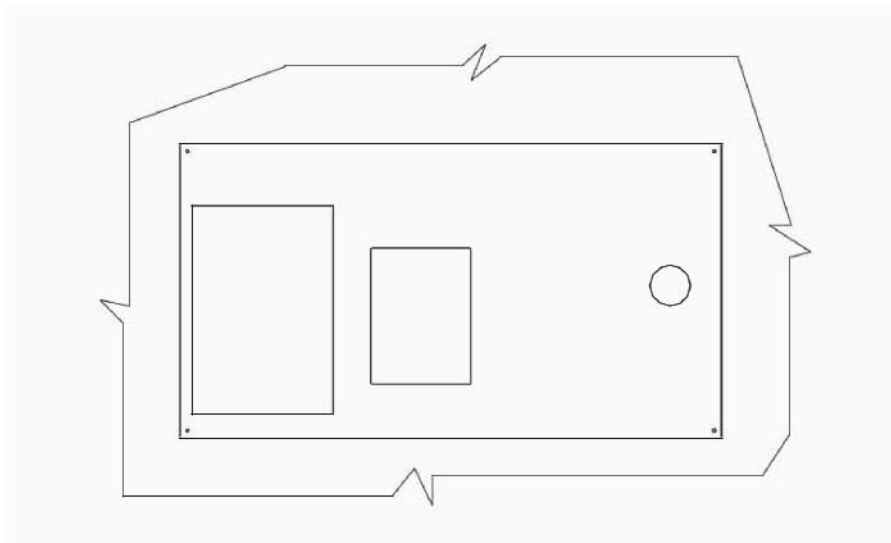

- ⚠ The machine must be installed completely level. There is a maximum angle of 10° to prevent condensation leakage.
- ⚠ Prior to cutting the holes, verify that there are no cables, gas pipes, or parts of the chassis frame or similar fixtures underneath or hidden below.
- ⓘ Seal the machined surfaces of the floor openings with water-repellant solutions.

*The provided kit is used
to secure the machine to
the interior floor.*

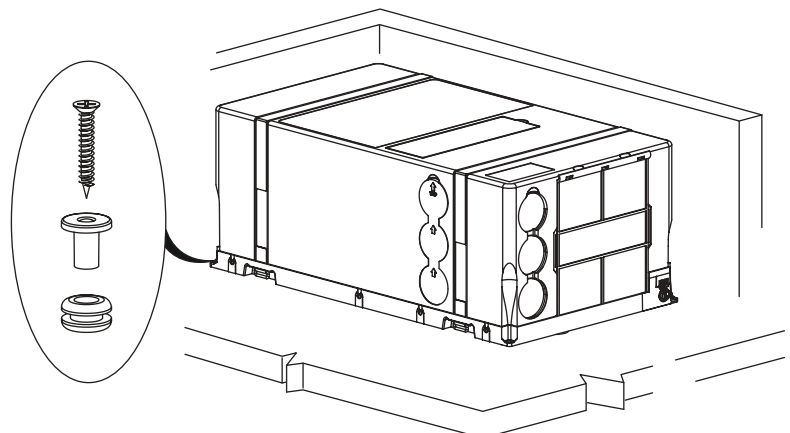

INSTALLATION INSTRUCTIONS

Securing the System to the Floor

The following pieces of hardware (included) will be used to fix the system to the floor:

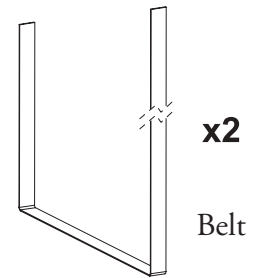

There are three different methods of fixing the system to the floor using different combinations of the above hardware, depending on preference, explained later.

ⓘ Preparing the Bottom Openings (Top View):

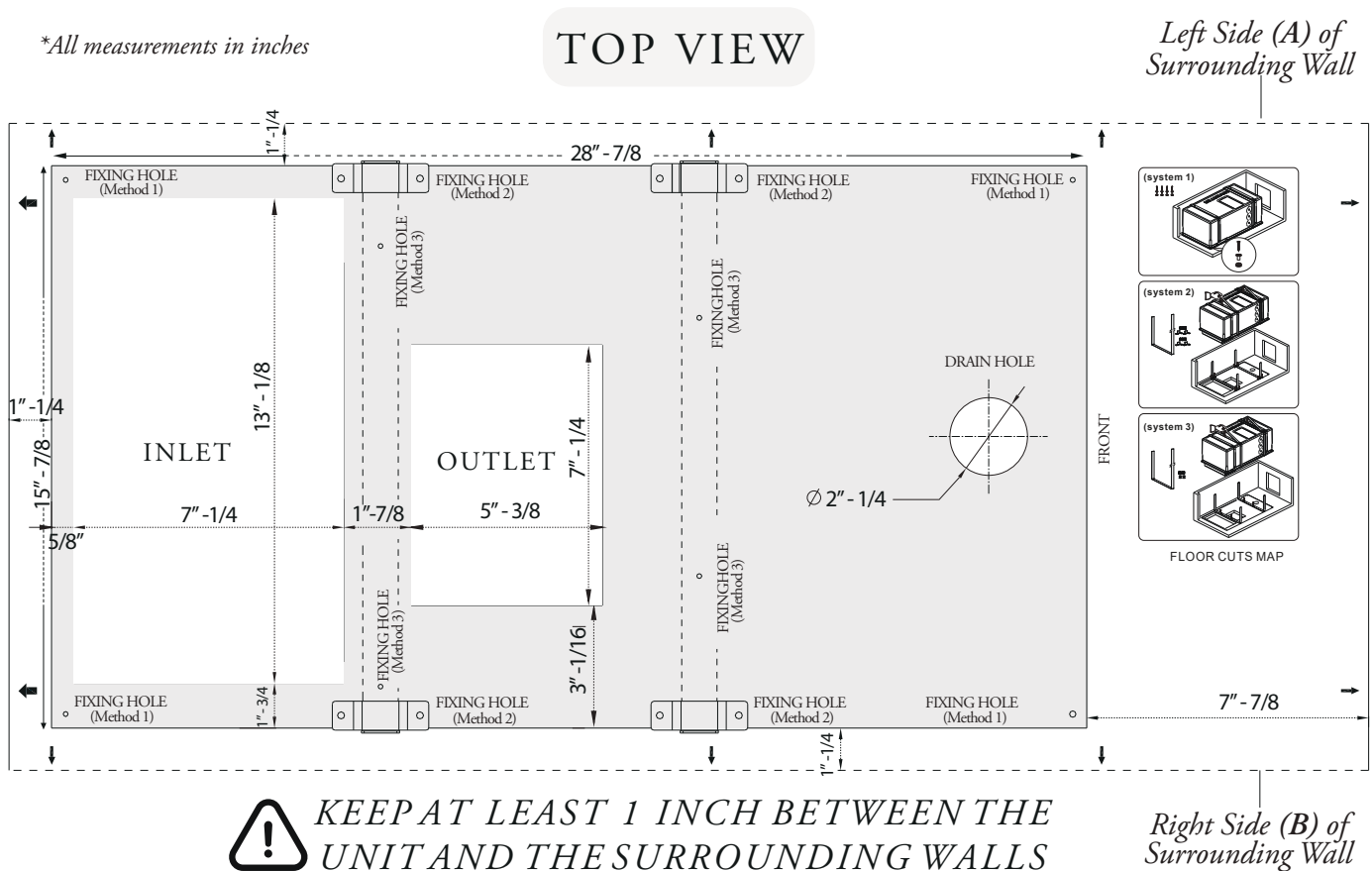

1. Use the included template as depicted above to mark the locations of the openings.
2. Carefully cut out the openings at the bottom using a reciprocating saw or other cutting tool.
3. Drill out the necessary 2"-1/4 diameter condensate drainage hole using a hole saw.
4. Mark the locations of the fastening screws and the brackets using the above template after selecting the desired method of fixing the system to the floor.

INSTALLATION INSTRUCTIONS

Fastening the System Into Place

ⓘ Three Methods Are Available for Fastening:

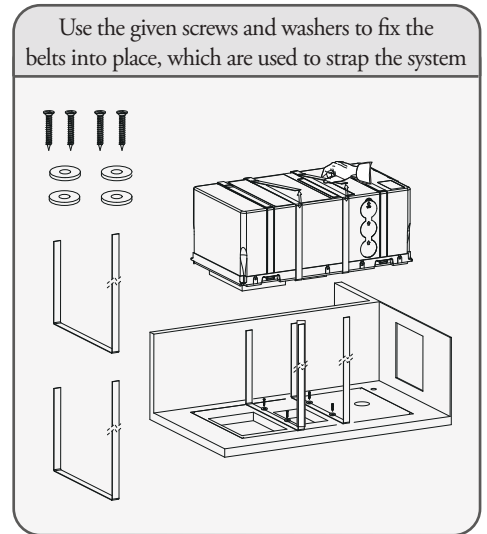
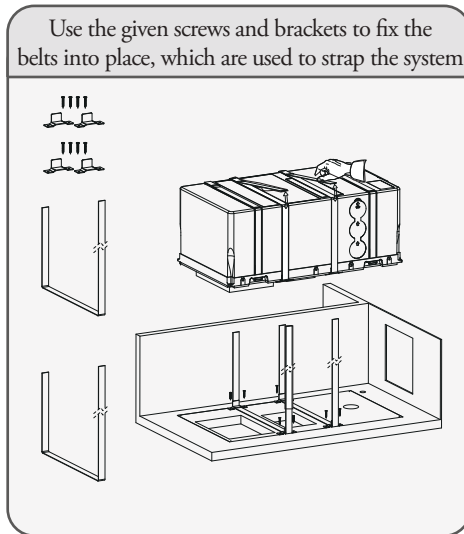
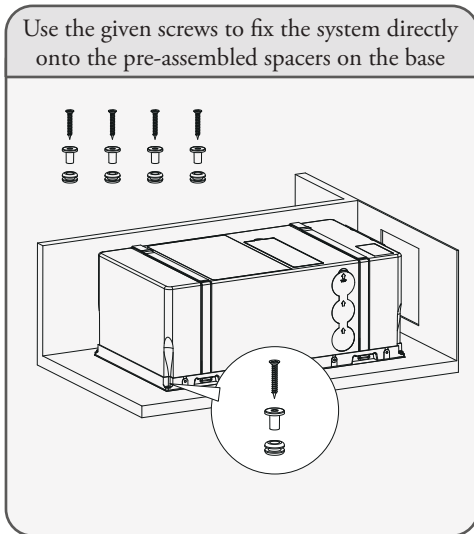

Select the method that works best for the installation and proceed.

- Use the given screws to fix the system directly onto the pre-assembled spacers on the base.

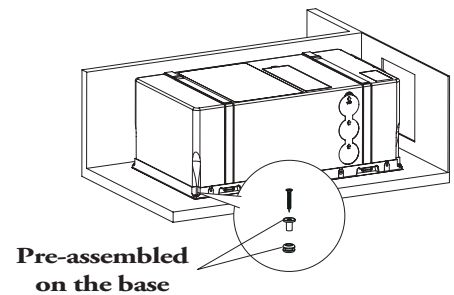

OR

- Use the given screws and brackets to fix the belts into place, which are used to strap the system.

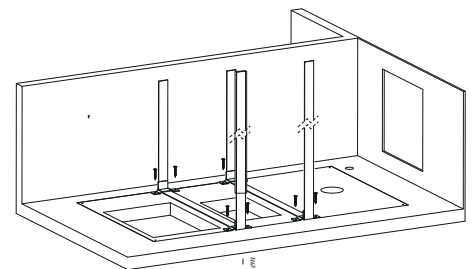
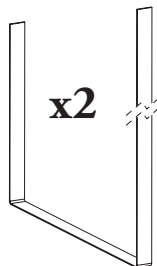
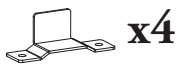

OR

- Use the given screws and washers to fix the belts into place, which are used to strap the system.

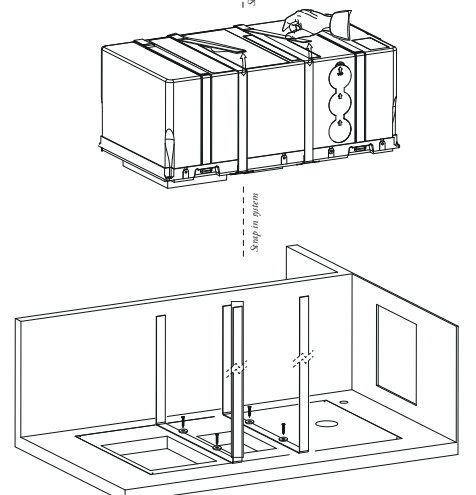
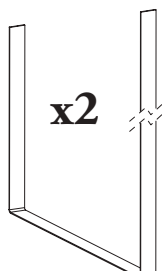

INSTALLATION INSTRUCTIONS

Placement of the Wall Thermostat

Locate the wall thermostat, handheld remote controller, batteries, thermostat support bracket, and extension cable.

These items are typically found within the hidden compartment on top of the system itself during first installation.

Secure the steel plate to the wall using self-tapping screws. The distance between the two holes should be $2\text{''}-3/8$ inches, and the hole diameter should be less than 2 inches. Use M4 x 1.5 cm pan head, cross-point, self-tapping screws.

Once the wiring is properly connected, position the thermostat against the steel plate and slide the buckle down to secure it in place.

The installation is now complete.

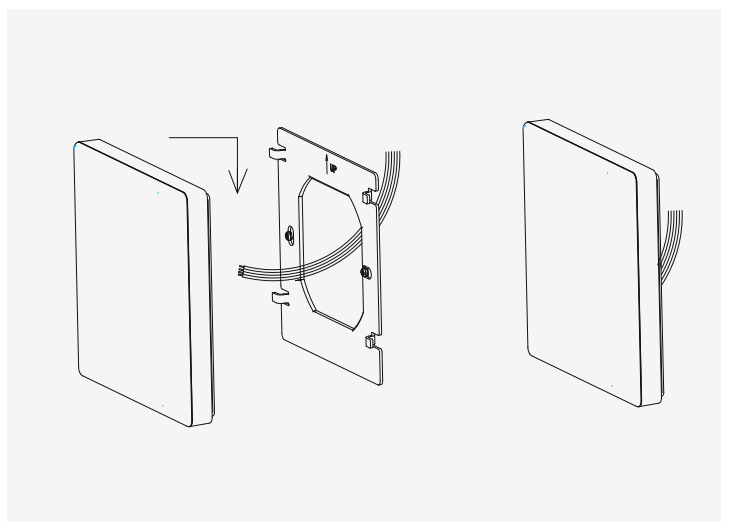
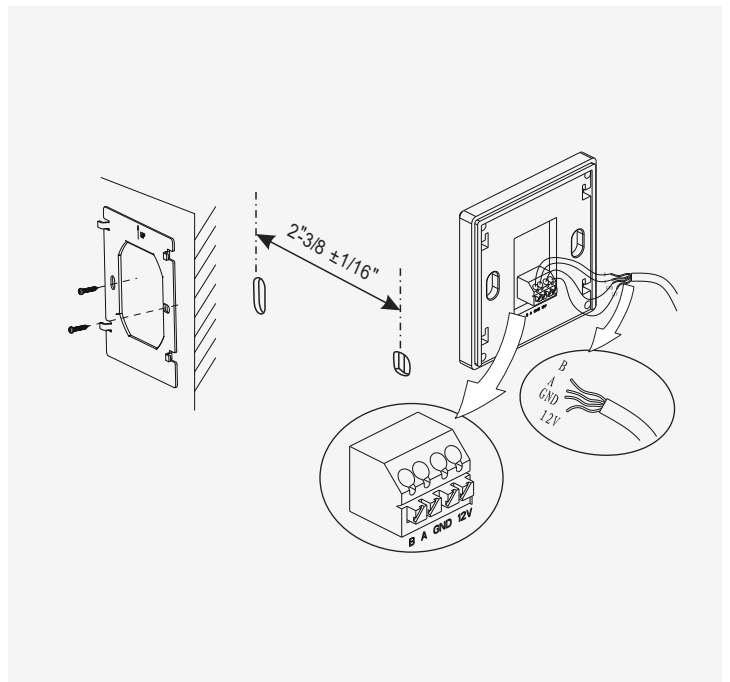
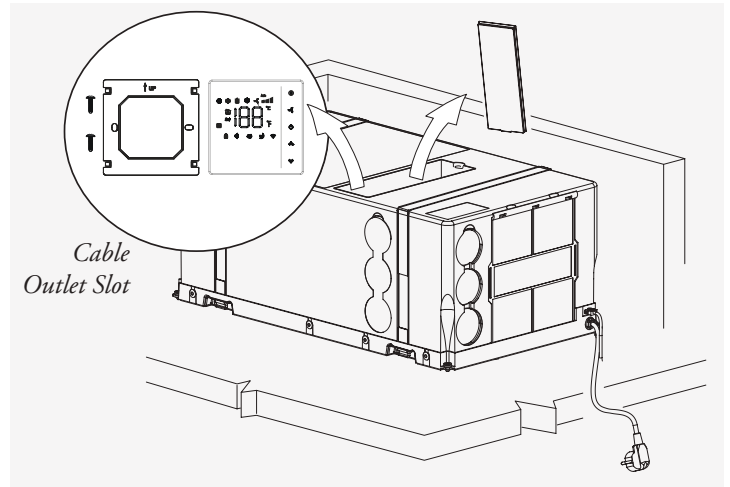

INSTALLATION INSTRUCTIONS

Recirculation Air Compartment Opening

❶ Final Cutout Opening for Recirculation Air:

Create an additional hole in the compartment where the system is installed, in order to permit recirculation of the internal air.

It would be best to locate the cutout near to the front of the machine. If the opening cannot be made near the machine, ensure that the air flow is not obstructed by anything and create an air duct between the opening and the machine, if necessary.

The cutout should be roughly 50 in² in size, and the hole will be closed with a grille supplied.

Only allow this recirculation air to enter the compartment from within the passenger section. If the air entering this opening is from the outside, the performance of the machine would diminish.

Finally, install the condensation drain tubes provided with the system onto the bottom ports.

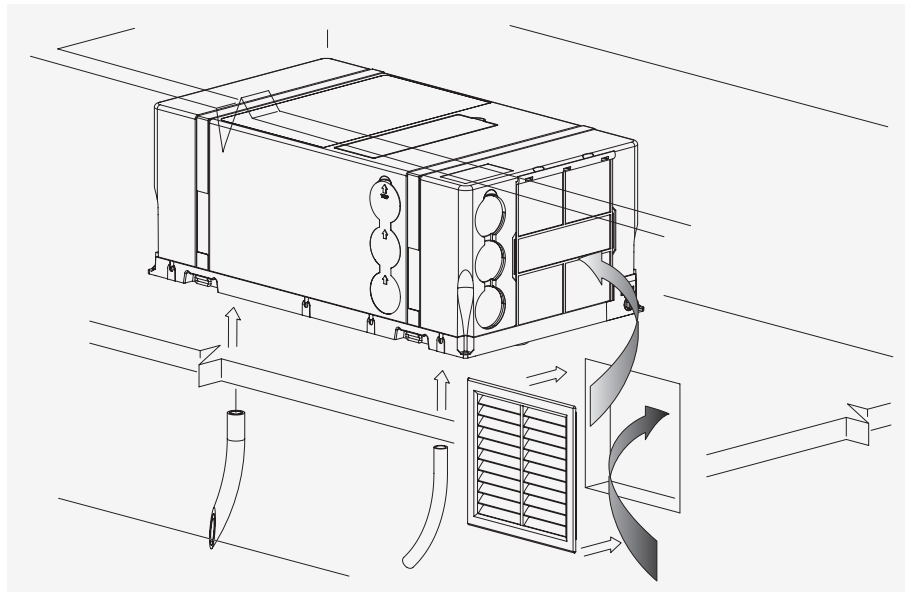

Air Ducting

❷ Ductwork Best Practices:

Craft the ducting used to distribute the air using trade parts which are **not** included with this system supply.

It is advised to use cardboard pipe for air conditioning, with an aluminum core and external PVC covering.

The nominal Inner Diameter should be sized up to 2"-3/8, and the Outer Diameter up to 2"-1/2.

The tapered hole on the air outlet allows the ventilation ducts to be joined by pressing them together.

Use either the outlet on the coil side, or the side outlet (by removing the guard and closing the front holes) to connect the ducts.

The ventilation pipes are connected by pressing them into the tapered hole on the air outlet. The pipes can be attached either to the outlet on the coil side or, by removing the guard and closing the front holes, to the side outlet.

A compatible PIONEER air distribution kit is conveniently sold online under reference item number IKT-UB3AO-10DHK.

For optimal efficiency, it is advised to:

- Route the air ducts as short and flat as possible.
- Do not exceed 16 ft in duct length.
- Avoid laying the air ducts near any sources of heat.

☞ *Avoid condensation on the ducting by insulating the pipes with insulation material (sold separately).*

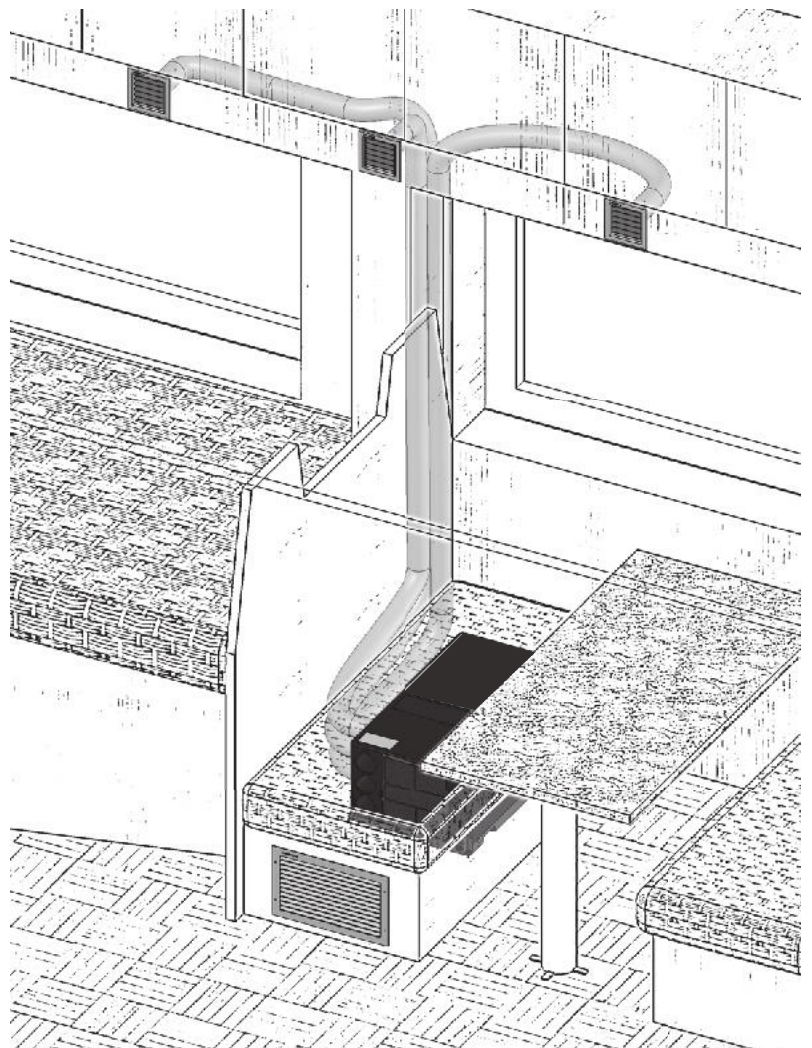

INSTALLATION INSTRUCTIONS

Electrical Hookup

ⓘ Connection and Powering Up of System:

Connect the receiver extension socket to the system, and power up the machine by inserting the included power plug into a 115V/60Hz outlet.

Before switching on, ensure that the electrical supply and the extension used are capable of withstanding the power input required by the system (*see technical data and/or nameplate*).

The installation process is now complete.

For any troubleshooting steps, please see Page 23.

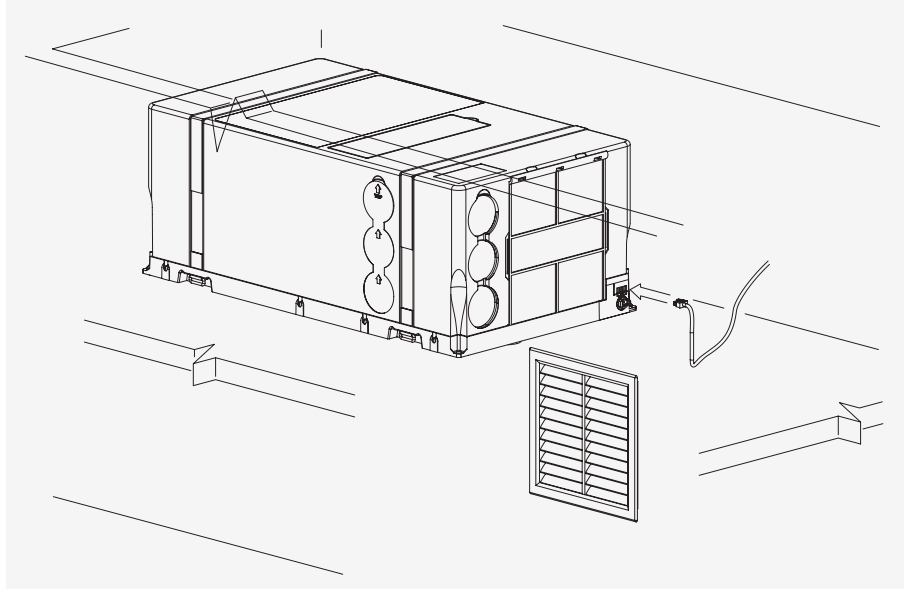

Simplified Wiring Diagram of PYR009AZUDCIPD

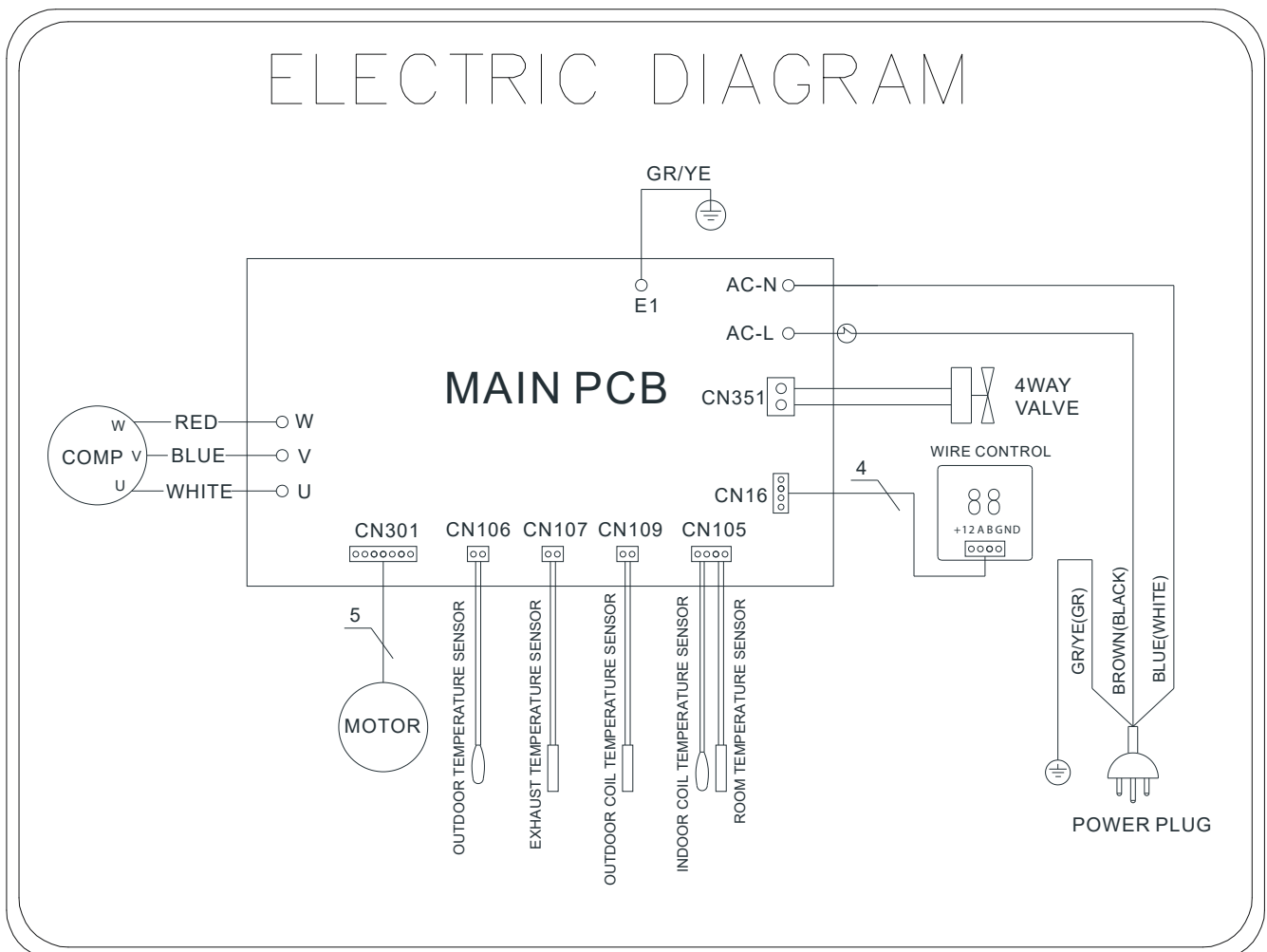

INSTALLATION INSTRUCTIONS

Wireless Internet Connection - Application Download

Installation of “Pioneer Airlink” smartphone application

Search for “Pioneer Airlink” in the Google Play Store (for Android users) or the App Store (for iOS users). Note that a 2.4GHz Wi-Fi connection is needed to use the Wi-Fi control feature.



Or, scan the below QR code to download the app from the respective app store.



Download Android App



Download iOS App

Wireless Internet Connection - Setup Process

Wireless Control App Setup Process

1. Registration and Log-In:

If you do not already have a “Pioneer Airlink” account, please create an account and log-in by following the below steps:

- Approve the “User Agreement” and “Privacy Policy” when they appear by tapping “I Agree”.
- Tap the “Sign Up” button, choose your country, and enter your mobile number/e-mail to register, tick “I Agree” on “User Agreement and Privacy Policy”, then tap the “Get Verification Code” button. The phone or e-mail that you’re registering will receive a registration verification code.
- Enter the verification code and select a password. You will then either land on the homepage of the App, or back to the login interface to log into the app, by using the account you just created.

2. Adding a New Device:

- Confirm that your phone is connected to Wi-Fi (2.4GHz networks only, 5Ghz will not work). Tap the “+” at the top-right corner of the homepage, to enter the device selection page.
- Once you’ve entered this page, locate the [-] button on the top right and scan the below QR code. The app will confirm that you wish to add the RV system thermostat, select “add”.

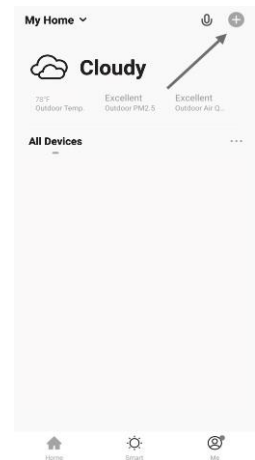

Fig.1

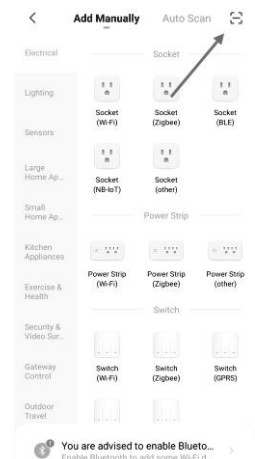

Fig.2

Scan this QR code

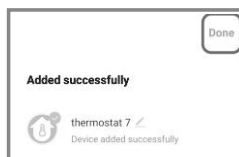

Fig.3

INSTALLATION INSTRUCTIONS

Wireless Internet Connection - Setup Process (Manual Mode)

📍 Network Distribution Mode:

1. EZ Mode

- Confirm that your phone is connected to Wi-Fi (2.4GHz networks only, 5GHz will not work). Tap the “+” at the top-right corner of the homepage, to enter the device selection page. (Fig. 1)
- When the thermostat is off, press and hold the “∇” until the thermostat screen flashes quickly and displays the “📶” icon, and then operate according to the following figures (Fig. 4-Fig. 8)

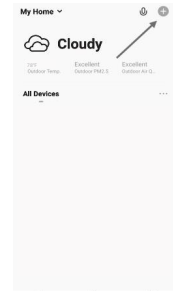

Fig.1

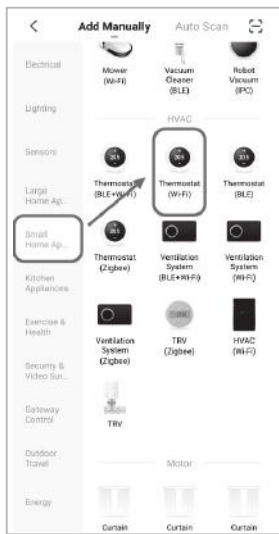

Fig.4

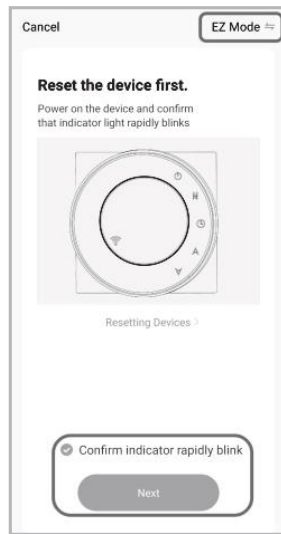

Fig.5



Fig.6



Fig.7

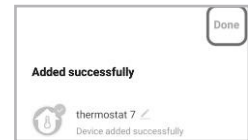

Fig.8

2. AP Mode

- Confirm that your phone is connected to Wi-Fi (2.4GHz networks only, 5GHz will not work). Tap the “+” at the top-right corner of the homepage, to enter the device selection page. (Fig. 1)
- When the thermostat is off, press and hold the “∇” until the thermostat screen flashes slowly and the “📶” icon is displayed (if the “📶” icon appears, continue to press the “∇” until the thermostat screen flashes slowly and displays the “📶” icon), and then operate according to the following figure (Fig.9-Fig.14 + Fig. 8)

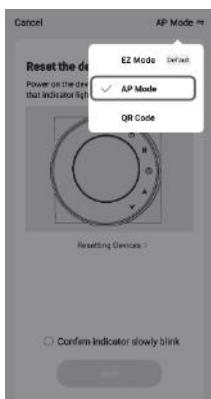

Fig.9

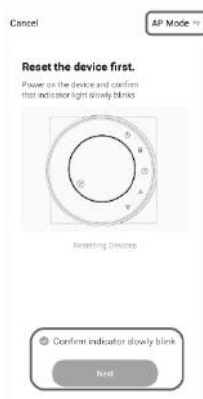

Fig.10



Fig.11



Fig.12



Fig.13



Fig.14

TROUBLESHOOTING, MAINTENANCE, RECYCLING

Troubleshooting and Diagnosis

MALFUNCTION	POSSIBLE CAUSES
If the appliance is not cooling...	The current temperature is lower than 64°F
	The set point temperature has been satisfied
	Defective thermistor or thermal protection
	Low refrigerant
	The compressor is damaged
	The heat exchanger coils are dirty
	The external fan is defective
	The MODE button is not in the right position
If the appliance is not heating...	The current temperature is higher than 86°F
	The set point temperature has been satisfied
	Defective thermistor or thermal protection
	Low refrigerant
	The compressor is damaged
	The heat exchanger coils are dirty
	Damaged/Stuck 4-Way Valve
	The MODE button is not in the right position
If the airflow is insufficient, or no longer circulates inside the vehicle...	The heat exchanger coils are dirty
	The internal/interior fan is malfunctioning
	The air filter is dirty/obstructed
If there is water seeping into the vehicle...	The condensate drain hose is cracked, clogged, or is not secured onto the exhaust port
If the machine does not start...	Defective thermal protection
	Damaged Compressor
	There is insufficient power going into the unit
	The voltage is too low (less than 100V)
	The electric condenser is damaged/malfunctioning
If the machine stops working...	Defective thermistor or thermal protection
	The heat exchanger coils are dirty
	The air filter is dirty/obstructed
	The external fan is defective
	The voltage is too low (less than 100V)
	The electric condenser is damaged/malfunctioning

Special Supplemental Maintenance:

For optimal efficiency, it is recommended to have your dealer/contractor perform designated cleaning prior to using, on the heat exchange coils and the condensation drain holes.

TROUBLESHOOTING, MAINTENANCE, RECYCLING

Troubleshooting and Diagnosis

📌 Querying the System for Errors

When in startup mode, press and hold the "UP" button for 3 seconds. The system will beep three times, indicating that the real-time operating frequency of the compressor is being checked.

To exit the frequency query function and return to the normal display, press and hold the "UP" button again for 3 seconds. The system will beep twice simultaneously to confirm the action.

Fault Code	Information
A1	Indoor side EE malfunction
A2	Evaporator fan motor malfunction
A4	Evaporator sensor malfunction
A5	Indoor ambient temperature sensor malfunction
Er	Communication failure between main board and thermostat
E5	Four-way valve reversing failure
E6	Low refrigerant fault
A8	Outdoor EE malfunction
B4	The compressor starts abnormally (Lack of phase/reversal)
B5	Compressor out-of-step failure
B6	IPM Module failure
B8	Discharge air temperature sensor malfunction
C2	Condensor temperature sensor malfunction
C3	Outdoor ambient temperature sensor malfunction
C4	Outdoor DC fan motor failure
FL	Full water pan protection shutdown
D1	The outdoor unit has shut down for AC current protection
D2	Compressor phase current protection shutdown
D3	Outdoor side AC voltage high/low protection
D4	DC bus voltage high/low protection
D5	IPM high temperature protection shutdown
D6	Discharge air temperature too high cause shutdown protection
D7	Cooling evaporator anti-freezing protection shutdown
D8	Condenser coil overheat shutdown protection in cooling mode
E1	Heating mode evaporator overheat protection shutdown
E2	Protection shutdown against low outdoor ambient temperature at cooling mode
E3	Protection shutdown against high outdoor ambient temperature at heating mode
C5	Drive bus overvoltage protection
C6	Drive bus for undervoltage protection
C7	Drive phase current overcurrent fault
C8	Abnormal phase current sampling

TROUBLESHOOTING, MAINTENANCE, RECYCLING

Exploded Parts Diagram of PYR009AZUDCIPD

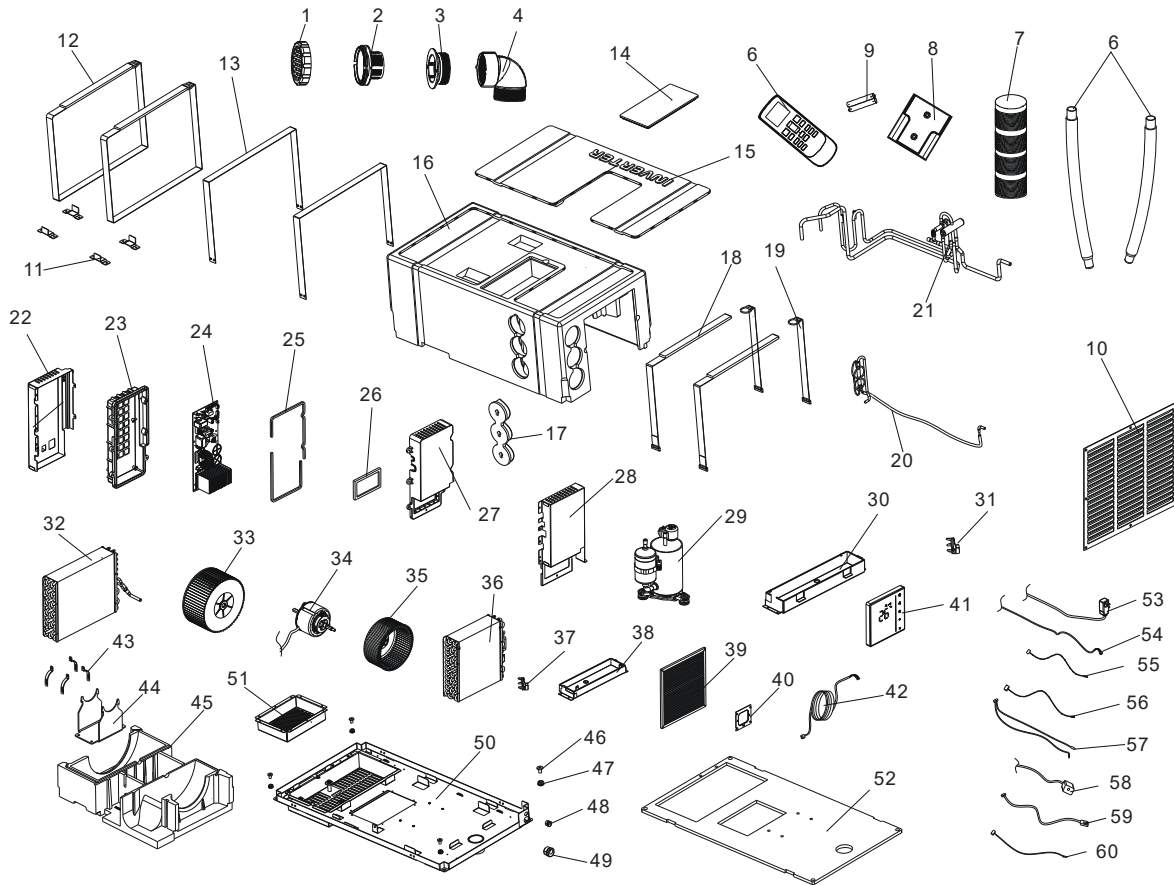

Spare Parts Reference List of PYR009AZUDCIPD

Ref. No.	Description	Ref. No.	Description	Ref. No.	Description
1	GRILLE	21	4-WAY VALVE ASSEMBLIES	41	WALL PAD CONTROLLER
2	GRILLE SUPPORT	22	ELECTRIC BOX BASE PLATE	42	WALL PAD WIRE HARNESS
3	BUSHING	23	PCB MOUNTING BOX BASE	43	MOTOR RETAINING CLIP
4	90° ELOW	24	PCB MAIN BOARD	44	MOTOR BRACKET
5	REMOTE CONTROL	25	SILICONE SEAL	45	BASE EPP
6	DRAIN PIPE	26	HEATSINK COVER	46	PLASTIC BRACKET
7	AIR PIPE	27	PCB MOUNTING COVER	47	RUBBER BRACKET
8	REMOTE SUPPORT	28	ELECTRICAL BOX PLATE	48	FASTENER (PAD HARNESS)
9	BATTERIES (AAA)	29	COMPRESSOR	49	FASTENER (POWER CORD)
10	RETURN AIR GRILLE	30	DRAIN PAN FOR COND.	50	CHASSIS
11	BUCKLE	31	SENSOR BRACKET	51	AIR OUTLET FIXING PLATE
12	FASTENING BELT C	32	CONDENSER	52	CHASSIS FOAM
13	EPP FASTENING PLATE	33	CONDENSER FAN BLOWER	53	POWER CORD
14	ACCESSORY BOX EPP	34	MOTOR	54	PAD CONNECTION CORD
15	HOUSING COVER EPP	35	EVAPORATOR FAN BLOWER	55	OUTDOOR TEMP. SENSOR
16	HOUSING EPP	36	EVAPORATOR	56	OUTDOOR COIL SENSOR
17	AIR OUTLET PLUG EPP	37	SENSOR BRACKET	57	INDOOR TEMP SENSORS
18	FIXING BELT A	38	DRAIN PAN FOR EVAP	58	4-WAY VALVE COIL
19	FIXING BELT C	39	FILTER	59	MOTOR WIRING HARNESS
20	CAPILLARY ASSEMBLIES	40	WALL CONTROL BRACKET	60	DISCHARGE TEMP. SENSOR

TROUBLESHOOTING, MAINTENANCE, RECYCLING

European Disposal Guidelines

This appliance contains refrigerant and other potentially hazardous materials. When disposing of this appliance, the law requires special collection and treatment. Do not dispose of this product as household waste or unsorted municipal waste.

When disposing of this appliance, you have the following options:

- Dispose of the appliance at a designated municipal electronic waste collection facility.
- When buying a new appliance, the retailer takes back the old appliance free of charge.
- The manufacturer takes back the old appliance free of charge.
- Sell the appliance to certified scrap metal dealers.

Special Notice

Disposing of this appliance improperly, or in other natural surroundings, endangers your health and is bad for the environment. Hazardous substances may leak into the ground water and enter the food chain. Please follow proper disposal protocol.

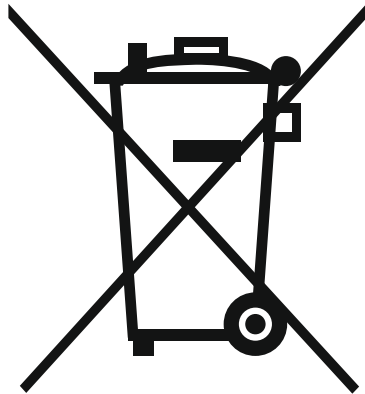

This page intentionally left blank

This page intentionally left blank

This page intentionally left blank

The design and specifications of this product are subject to change without prior notice as development continues. Consult with the sales agency or manufacturer for details. Refer to the equipment nameplate for all other applicable specifications.



is a registered trademark of Parker Davis HVAC International

Parker Davis HVAC International
7290 NW 77th Court, Miami, FL 33166 - USA
Tel : (305) 513-4488
Fax : (305) 513-4499
E-mail : info@pd-hvac.com
Website : www.pd-hvac.com

Pioneer product line, parts, and supplies are available online for convenient ordering at:
www.highseer.com
www.pioneerminisplit.com

Scan the below code to visit our support page where you can find more installation materials:

