

DENON

STEREO CD PLAYER

DCM-5000

OPERATING INSTRUCTIONS

MODE D'EMPLOI

INSTRUCCIONES DE OPERACION

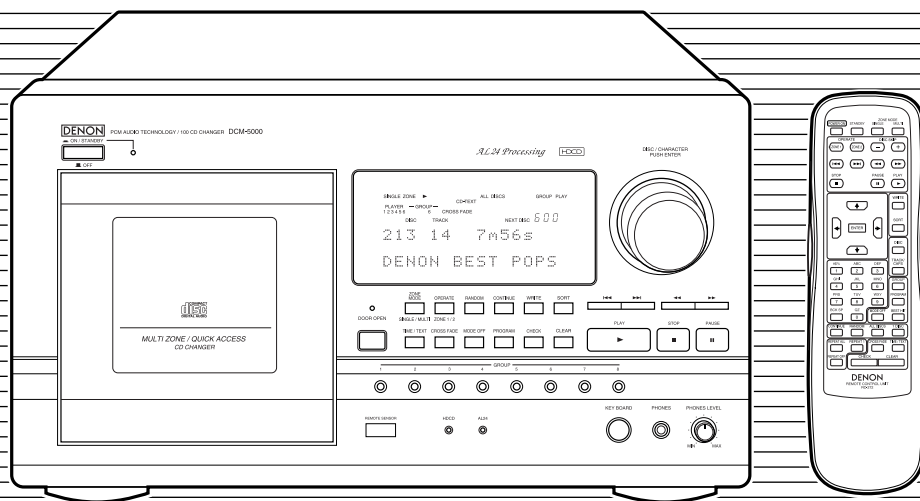

FOR ENGLISH READERS	PAGE	5 ~ PAGE	41
POUR LES LECTEURS FRANCAIS	PAGE	42 ~ PAGE	78
PARA LECTORES DE ESPAÑOL	PAGINA	79 ~ PAGINA	115

IMPORTANT TO SAFETY

WARNING:

TO PREVENT FIRE OR SHOCK HAZARD, DO NOT EXPOSE THIS APPLIANCE TO RAIN OR MOISTURE.

CAUTION:

1. Handle the power supply cord carefully

Do not damage or deform the power supply cord. If it is damaged or deformed, it may cause electric shock or malfunction when used. When removing from wall outlet, be sure to remove by holding the plug attachment and not by pulling the cord.

2. Do not open the top cover

In order to prevent electric shock, do not open the top cover. If problems occur, contact your DENON dealer.

3. Do not place anything inside

Do not place metal objects or spill liquid inside the CD player. Electric shock or malfunction may result.

Please, record and retain the Model name and serial number of your set shown on the rating label.

Model No. DCM-5000 Serial No. _____



CAUTION

RISK OF ELECTRIC SHOCK

DO NOT OPEN



CAUTION: TO REDUCE THE RISK OF ELECTRIC SHOCK, DO NOT REMOVE COVER (OR BACK). NO USER-SERVICEABLE PARTS INSIDE. REFER SERVICING TO QUALIFIED SERVICE PERSONNEL.

The lightning flash with arrowhead symbol, within an equilateral triangle, is intended to alert the user to the presence of uninsulated "dangerous voltage" within the product's enclosure that may be of sufficient magnitude to constitute a risk of electric shock to persons.

The exclamation point within an equilateral triangle is intended to alert the user to the presence of important operating and maintenance (servicing) instructions in the literature accompanying the appliance.

• FOR U.S.A. & CANADA MODEL ONLY

CAUTION

TO PREVENT ELECTRIC SHOCK DO NOT USE THIS (POLARIZED) PLUG WITH AN EXTENSION CORD, RECEPTACLE OR OTHER OUTLET UNLESS THE BLADES CAN BE FULLY INSERTED TO PREVENT BLADE EXPOSURE.

• POUR LES MODELES AMERICAINS ET CANADIENS UNIQUEMENT

ATTENTION

POUR PREVENIR LES CHOCS ELECTRIQUES NE PAS UTILISER CETTE FICHE POLARISEE AVEC UN PROLONGATEUR UNE PRISE DE COURANT OU UNE AUTRE SORTIE DE COURANT, SAUF SI LES LAMES PEUVENT ETRE INSEREES A FOND SANS EN LAISSER AUCUNE PARTIE A DECOUVERT.

NOTE:

This CD player uses the semiconductor laser. To allow you to enjoy music at a stable operation, it is recommended to use this in a room of 5 °C (41 °F) ~ 35 °C (95 °F).

LABELS (for U.S.A. model only)

CERTIFICATION

THIS PRODUCT COMPLIES WITH DHHS RULES 21 CFR SUBCHAPTER J APPLICABLE AT DATE OF MANUFACTURE.

CAUTION:

USE OF CONTROLS OR ADJUSTMENTS OR REFORMATION OF PROCEDURES OTHER THAN THOSE SPECIFIED HEREIN MAY RESULT IN HAZARDOUS RADIATION EXPOSURE.

THE COMPACT DISC PLAYER SHOULD NOT BE ADJUSTED OR REPAIRED BY ANYONE EXCEPT PROPERLY QUALIFIED SERVICE PERSONNEL.

This device complies with Part 15 of the FCC Rules. Operation is subject to the following two conditions : (1) This device may not cause harmful interference, and (2) this device must accept any interference received, including interference that may cause undesired operation.

This Class B digital apparatus meets all requirements of the Canadian Interference-Causing Equipment Regulations.

Cet appareil numérique de la classe B respecte toutes les exigences du Règlement sur le matériel brouilleur du Canada.

Use compact discs that include the  mark.

CD's with special shapes (heart-shaped CD's, octagonal CD's etc.) cannot be played on this set.

Attempting to do so may damage the set. Do not use such CD's.

Utiliser des disques compacts portant le logo .

Des CD avec des formes spéciales (CD en forme de coeur, des CD octogonaux, etc.) ne peuvent pas être lus sur cet appareil.

Le fait de l'essayer, risque d'endommager le lecteur. Ne pas utiliser de tels CD.

Use discos compactos con la marca .

En este equipo no es posible reproducir CDs con formas especiales (CDs con forma de corazón, CDs octogonales, etc.).

Si intenta hacerlo, el equipo podrá resultar dañado. No use este tipo de CDs.



CLASS 1 LASER PRODUCT
LUOKAN 1 LASERLAITE
KLASS 1 LASERAPPARAT

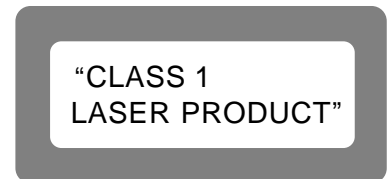

ADVARSEL: USYNLIG LASERSTRÅLING VED ÅBNING, NÅR SIKKERHEDSAFBRYDERE ER UDE AF FUNKTION. UNDGÅ UDSAETTELSE FOR STRÅLING.

VAROITUS: LAITTEEN KÄYTTÄMINEN MUULLA KUIN TÄSSÄ KÄYTTÖOHJEESSA MAINITULLA TAVALLA SAATTAA ALTISTAA KÄYTTÄJÄN TURVALLISUUSLUOKAN 1 YLITTÄVÄLLE NÄKYMÄMTTÖMÄLLE LASERSÄTEILYLLE.

ARNING-- OM APPARATEN ANVÄNDS PÅ ANNAT SÄTT ÄN I DENNA BRUKSANVISNING SPECIFICERATS, KAN ANVÄNDAREN UTSÄTTAS FÖR OSYNLIG LASERSTRÅLNING SOM ÖVERSKRIDER GRÄNSEN FÖR LASERKLASS 1.

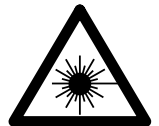

• DECLARATION OF CONFORMITY

We declare under our sole responsibility that this product, to which this declaration relates, is in conformity with the following standards:

EN60065, EN55013, EN55020, EN60555-2 and EN60555-3.

Following the provisions of 73/23/EEC, 89/336/EEC and 93/68/EEC Directive.

• DECLARATION DE CONFORMITE

Nous déclarons sous notre seule responsabilité que l'appareil, auquel se réfère cette déclaration, est conforme aux standards suivants:

EN60065, EN55013, EN55020, EN60555-2 et EN60555-3.

D'après les dispositions de la Directive 73/23/EEC, 89/336/EEC et 93/68/EEC.

• DECLARACIÓN DE CONFORMIDAD

Declaramos bajo nuestra exclusiva responsabilidad que este producto al que hace referencia esta declaración, está conforme con los siguientes estándares:

EN60065, EN55013, EN55020, EN60555-2 y EN60555-3.

Seguendo las provisiones de las Directivas 73/23/EEC, 89/336/EEC y 93/68/EEC.

SAFETY INSTRUCTIONS

1. Read Instructions – All the safety and operating instructions should be read before the appliance is operated.
2. Retain Instructions – The safety and operating instructions should be retained for future reference.
3. Heed Warning – All warnings on the appliance and in the operating instructions should be adhered to.
4. Following Instructions – All operating and use instructions should be followed.
5. Water and Moisture – The appliance should not be used near water – for example, near a bathtub, washbowl, kitchen sink, laundry tub, in a wet basement, or near a swimming pool, and the like.
6. Carts and Stands – The appliance should be used only with a cart or stand that is recommended by the manufacturer.
- 6A. An appliance and cart combination should be moved with care. Quick stops, excessive force, and uneven surfaces may cause the appliance and cart combination to overturn.
7. Wall or Ceiling Mounting – The appliance should be mounted to a wall or ceiling only as recommended by the manufacturer.
8. Ventilation – The appliance should be situated so that its location or position does not interfere with its proper ventilation. For example, the appliance should not be situated on a bed, sofa, rug, or similar surface that may block the ventilation openings; or, placed in a built-in installation, such as a bookcase or cabinet that may impede the flow of air through the ventilation openings.
9. Heat – The appliance should be situated away from heat sources such as radiators, heat registers, stoves, or other appliances (including amplifiers) that produce heat.
10. Power Sources – The appliance should be connected to a power supply only of the type described in the operating instructions or as marked on the appliance.
11. Grounding or Polarization – Precautions should be taken so that the grounding or polarization means of an appliance is not defeated.



12. Power-Cord Protection – Power-supply cords should be routed so that they are not likely to be walked on or pinched by items placed upon or against them, paying particular attention to cords at plugs, convenience receptacles, and the point where they exit from the appliance.
14. Cleaning – The appliance should be cleaned only as recommended by the manufacturer.
15. Power Lines – An outdoor antenna should be located away from power lines.
16. Outdoor Antenna Grounding – If an outside antenna is connected to the receiver, be sure the antenna system is grounded so as to provide some protection against voltage surges and built-up static charges. Article 810 of the National Electrical Code, ANSI/NFPA 70, provides information with regard to proper grounding of the mast and supporting structure, grounding of the lead-in wire to an antenna-discharge unit, size of grounding conductors, location of antenna-discharge unit, connection to grounding electrodes, and requirements for the grounding electrode. See Figure A.
17. Nonuse Periods – The power cord of the appliance should be unplugged from the outlet when left unused for a long period of time.
18. Object and Liquid Entry – Care should be taken so that objects do not fall and liquids are not spilled into the enclosure through openings.
19. Damage Requiring Service – The appliance should be serviced by qualified service personnel when:
 - A. The power-supply cord or the plug has been damaged; or
 - B. Objects have fallen, or liquid has been spilled into the appliance; or
 - C. The appliance has been exposed to rain; or
 - D. The appliance does not appear to operate normally or exhibits a marked change in performance; or
 - E. The appliance has been dropped, or the enclosure damaged.
20. Servicing – The user should not attempt to service the appliance beyond that described in the operating instructions. All other servicing should be referred to qualified service personnel.

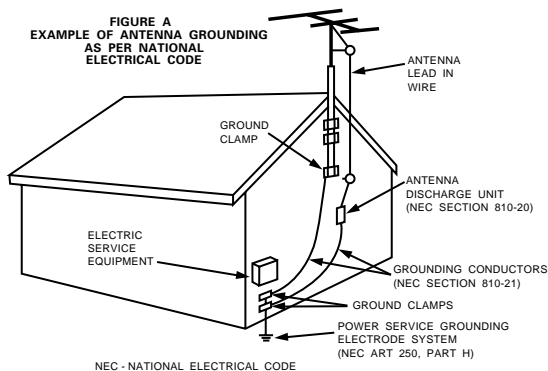

**NOTE ON USE / HINWEISE ZUM GEBRAUCH / OBSERVATIONS RELATIVES A L'UTILISATION
NOTE SULL'USO / NOTAS SOBRE EL USO / ALVORENS TE GEBRUIKEN / OBSERVERA
OBSERVAÇÕES QUANTO AO USO**

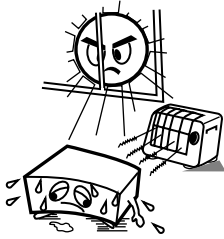

- Avoid high temperatures. Allow for sufficient heat dispersion when installed on a rack.
- Vermeiden Sie hohe Temperaturen. Beachten Sie, daß eine ausreichend Luftzirkulation gewährleistet wird, wenn das Gerät auf ein Regal gestellt wird.
- Eviter des températures élevées. Tenir compte d'une dispersion de chaleur suffisante lors de l'installation sur une étagère.
- Evitate di esporre l'unità a temperature alte. Assicuratevi che ci sia un'adeguata dispersione del calore quando installate l'unità in un mobile per componenti audio.
- Evite altas temperaturas. Permite la suficiente dispersión del calor cuando está instalado en la consola.
- Vermijd hoge temperaturen. Zorg voor een degelijk hitteafvoer indien het apparaat op een rek wordt geplaatst.
- Undvik höga temperaturer. Se till att det finns möjlighet till god värmeavledning vid montering i ett rack.
- Evite temperaturas altas. Conceda suficiente dispersão de calor quando o equipamento for instalado numa prateleira.

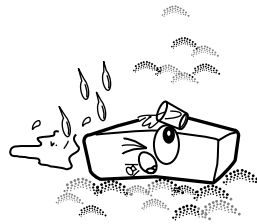

- Keep the set free from moisture, water, and dust.
- Halten Sie das Gerät von Feuchtigkeit, Wasser und Staub fern.
- Protéger l'appareil contre l'humidité, l'eau et la poussière.
- Tenete l'unità lontana dall'umidità, dall'acqua e dalla polvere.
- Mantenga el equipo libre de humedad, agua y polvo.
- Laat geen vochtigheid, water of stof in het apparaat binnendringen.
- Utsätt inte apparaten för fukt, vatten och damm.
- Mantenha o aparelho livre de qualquer umidade, água ou poeira.

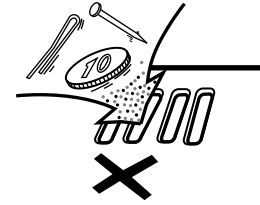

- Do not let foreign objects in the set.
- Keine fremden Gegenstände in das Gerät kommen lassen.
- Ne pas laisser des objets étrangers dans l'appareil.
- E' importante che nessun oggetto è inserito all'interno dell'unità.
- No deje objetos extraños dentro del equipo.
- Laat geen vreemde voorwerpen in dit apparaat vallen.
- Se till att främmande föremål inte tränger in i apparaten.
- Não deixe objetos estranhos no aparelho.

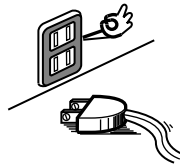

- Unplug the power cord when not using the set for long periods of time.
- Wenn das Gerät eine längere Zeit nicht verwendet werden soll, trennen Sie das Netzkabel vom Netzstecker.
- Débrancher le cordon d'alimentation lorsque l'appareil n'est pas utilisé pendant de longues périodes.
- Disinnestate il filo di alimentazione quando avete l'intenzione di non usare il filo di alimentazione per un lungo periodo di tempo.
- Desconecte el cordón de energía cuando no utilice el equipo por mucho tiempo.
- Neem altijd het netsnoer uit het stopcontact wanneer het apparaat gedurende een lange periode niet wordt gebruikt.
- Koppla ur nätkabeln om apparaten inte kommer att användas i lång tid.
- Desligue o fio condutor de força quando o aparelho não tiver que ser usado por um longo período.

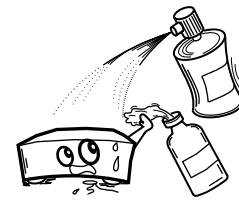

- Do not let insecticides, benzene, and thinner come in contact with the set.
- Lassen Sie das Gerät nicht mit Insektiziden, Benzin oder Verdünnungsmitteln in Berührung kommen.
- Ne pas mettre en contact des insecticides, du benzène et un diluant avec l'appareil.
- Assicuratevi che l'unità non venga in contatto con insetticidi, benzolo o solventi.
- No permita el contacto de insecticidas, gasolina y diluyentes con el equipo.
- Laat geen insectenverdelgende middelen, benzine of ververdunner met dit apparaat in contact komen.
- Se till att inte insektsmedel på spraybruk, bensen och thinner kommer i kontakt med apparatens hölje.
- Não permita que inseticidas, benzina e dissolvente entrem em contacto com o aparelho.

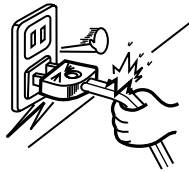

- Handle the power cord carefully. Hold the plug when unplugging the cord.
- Gehen Sie vorsichtig mit dem Netzkabel um. Halten Sie das Kabel am Stecker, wenn Sie den Stecker herausziehen.
- Manipuler le cordon d'alimentation avec précaution. Tenir la prise lors du débranchement du cordon.
- Manneggiare il filo di alimentazione con cura. Agitare per la spina quando scollegate il cavo dalla presa.
- Maneje el cordón de energía con cuidado. Sostenga el enchufe cuando desconecte el cordón de energía.
- Hanteer het netsnoer voorzichtig. Houd het snoer bij de stekker vast wanneer deze moet worden aan- of losgekoppeld.
- Hantera nätkabeln varsamt. Håll i kabeln när den kopplas från el-uttaget.
- Manuseie com cuidado o fio condutor de energia. Segure a tomada ao desconectar o fio.

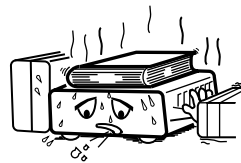

* (For sets with ventilation holes)

- Do not obstruct the ventilation holes.
- Die Belüftungöffnungen dürfen nicht verdeckt werden.
- Ne pas obstruer les trous d'aération.
- Non coprite i fori di ventilazione.
- No obstruya los orificios de ventilación.
- De ventilatieopeningen mogen niet worden beblokkeerd.
- Täpp inte till ventilationsöppningarna.
- Não obstrua os orifícios de ventilação.



- Never disassemble or modify the set in any way.
- Versuchen Sie niemals das Gerät auseinander zu nehmen oder auf jegliche Art zu verändern.
- Ne jamais démonter ou modifier l'appareil d'une manière ou d'une autre.
- Non smontate mai, nè modificate l'unità in nessun modo.
- Nunca desarme o modifique el equipo de ninguna manera.
- Nooit dit apparaat demonteren of op andere wijze modificeren.
- Ta inte isär apparaten och försök inte bygga om den.
- Nunca desmonte ou modifique o aparelho de alguma forma.

Thank you for purchasing the DENON compact disc player. Read the Operating Instructions thoroughly, and operate this player properly.

TABLE OF CONTENTS

1 MAIN FEATURES	5	11 USING DISC FILES	22 ~ 29
2 BEFORE USING	5	12 BEST HIT PLAY MODE	30 ~ 32
3 CAUTIONS ON INSTALLATION	6	13 OSD (On-Screen Display)	33 ~ 36
4 CAUTIONS DURING USE	6	14 CONNECTING AND OPERATING A KEYBOARD	37
5 CONNECTIONS	7	15 REMOTE CONTROL UNIT	38, 39
6 INSTALLATION	8, 9	16 COMPACT DISCS	40
7 FLUORESCENT DISPLAY	10	17 TROUBLESHOOTING	40
8 NORMAL PLAYBACK	11 ~ 14	18 ERROR MESSAGE	41
9 VARIOUS PLAYBACK FUNCTIONS	15 ~ 17	19 SPECIFICATIONS	41
10 PROGRAMMED PLAYBACK	18 ~ 21		

• ACCESSORIES

Check that the following parts are included in addition to the main unit.

- | | | | | | | | |
|--------------------------------|---|---------------------------------------|---|--------------------------------|---|--------------------------------------|---|
| ① Operating instructions | 1 | ② Warranty (North America model)..... | 1 | ③ Service station list | 1 | ④ Remote control unit (RC-272) | 1 |
| (European model.....) | 2 | ⑥ Connection cords (audio)..... | 2 | ⑦ Connection cord (video)..... | 1 | ⑧ CD booklet file and label..... | 1 |
| ⑤ R6P/AA batteries | 2 | | | | | | |

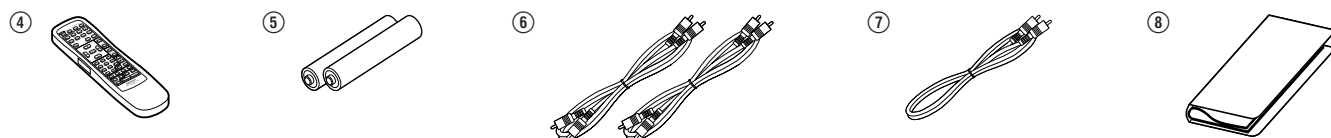

1 MAIN FEATURES

(1) 100-CD rack type CD changer

The CDs are stored in a rack so they can be loaded and replaced easily.

(2) Multi-zone system with two CD drive mechanisms

The DCM-5000 is equipped with two CD drive mechanisms, so separate playback signals can be output from the two zones.

(3) Quick access (in the single zone mode)

The two CD drive mechanisms can be used alternately so that CDs can be played consecutively with no waiting time when switching to the next CD.

In addition, a cross fade function makes it possible to switch from one CD to another naturally.

(4) CD Text compatibility

The DCM-5000 is compatible with CD Text discs, so the disc title, track titles and artist names recorded on the disc can be displayed.

(5) DISC file function

Disc titles, track titles and artist names can be stored in the memory for individual discs and the discs can be categorized in groups.

In addition, a keyboard (IBM PC type) can be connected so that disc files can be input from the keyboard.

The memory contents are, always preserved even in the event of prolonged power outage, due to the use of non-voltage memory storage.

(6) OSD (On-Screen Display)

A monitor TV can be connected to the VIDEO OUT jacks so that program editing, etc., can be performed while watching the monitor TV's screen.

(7) Daisy chain connection

Up to five DCM-5001s (sold separately) can be connected, transforming the system into a CD changer with a maximum of 600 discs.

(8) AL24 Processing and HDCD® (High Definition Compatible Digital®) decoder

(For zone 1 and in the single zone mode. Not applicable for zone 2.)

AL24 Processing is an analog waveform reproduction technology which carries over conventional ALPHA Processing and further reduces quantization distortion. It offers compatibility with the high number of bits and high sampling rates of next generation media.

HDCD is an encoding/decoding technology which greatly reduces distortion that occurs during digital recording while offering compatibility with the conventional CD format.

The DCM-5000 is equipped with an HDCD decoder that automatically identifies whether the CD is a conventional disc or an HDCD disc and conducts digital signal processing accordingly.

2 BEFORE USING

Pay attention to the following before using this unit:

• Moving the set.

To prevent short circuits or damaged wires in the connection cords, always unplug the power cord and disconnect the connection cords between all other audio components when moving the set.

• Before turning the power operation switch on.

Check once again that all connections are proper and that there are not problems with the connection cords. Always set the power operation switch to the standby position before connecting and disconnecting connection cords.

• Store this instructions in a safe place.

After reading, store this instructions along with the warranty in a safe place.

Also fill in the items on the back page for your convenience.

• Note that the illustrations in this instructions may differ from the actual set for explanation purpose.

3 CAUTIONS ON INSTALLATION

The CD player uses a microcomputer for controlling internal electronic circuits. In the event that the player is used while a near-by tuner or TV is turned on, although unlikely, interference could occur either in the sound from the tuner or the picture of the TV. To avoid this, please take the following precautions.

- Keep the CD player as far away from the tuner or TV set as possible.
- Keep the power cord and connecting cords of the CD player separate from the antenna wires of the tuner and TV.
- Interference is particular likely to occur when an indoor antenna or a 300 Ω /ohms feeder cable is used. Thus, use of an outdoor antenna and 75 Ω /ohms coaxial cable is strongly recommended.

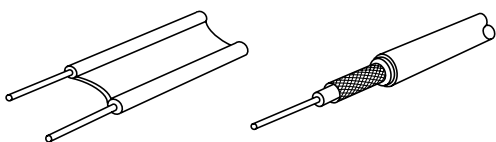
300 Ω /ohms feeder cable75 Ω /ohms coaxial cable

Be sure to install the player on a flat surface. Setting it at a slant may result in malfunction or damage.

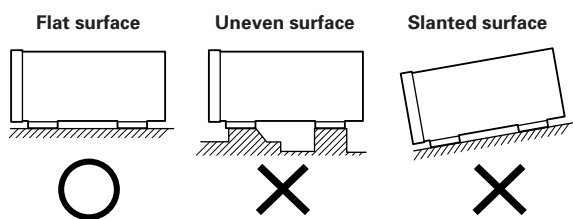

For heat dispersal, leave at least 10 cm of space between the top, back and sides of this unit and wall or other components.

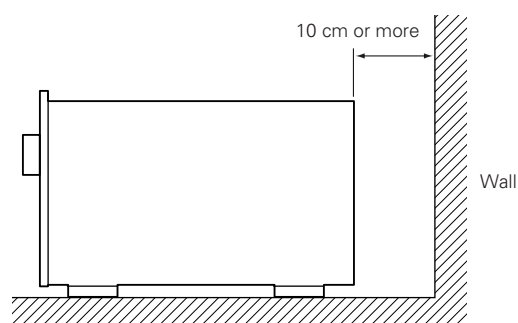
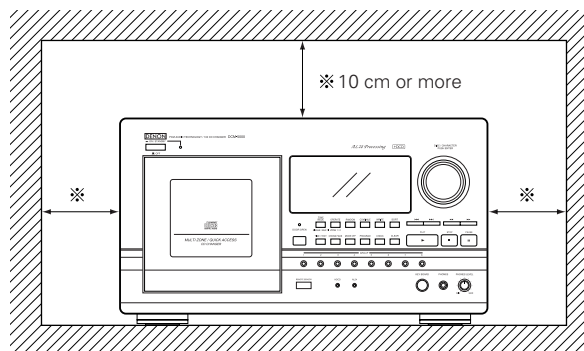

4 CAUTIONS DURING USE

- This compact disc player is capable of playing discs which have the mark at right.
- During track selection, during search and when the player sustains a strong impact, the disc's rotational speed changes greatly, causing a small noise to be emitted. This is not a malfunction of the player.
- If the CD player is operated while an FM or AM broadcast is being received, there may be noise in the FM or AM reception. Please switch the power to the CD player off at such times.
- The DCM-5000 has a broad dynamic range. Please exercise caution when turning up the volume on the amplifier in cases when the playback volume is low. If the volume is turned up too high, it could damage the speakers.



- Do not use any discs but exclusive audio discs with this CD player.
- Placing this player or its connection cords near a TV or other audio device could cause a humming sound to be emitted. If this occurs, relocate the player or reroute the connection cords.
- Be sure to remove the disc from the player before moving it. The discs could be damaged if left in the player while it is being moved.
- Do not move the player from a cold place to a warm place suddenly. If the player is cold when brought into a warm room, condensation could form, preventing proper operation of the player. If condensation does form on the player when it is brought into a warm room, wait at least 30 minutes before use.

5 CONNECTIONS

Connection Precautions

- Before proceeding with connections or disconnections of cable and power cords, be sure to turn all system components off.
- Ensure that all cables are connected properly to the L (left) and R (right) jacks.
- Insert plugs fully into the terminals.
- Connect the output jacks to the amplifier CD, AUX or TAPE PLAY input jacks.

Connecting the Analog Output Jacks

Connect one end of the connection cord supplied with the CD player to the output terminals, left (L) and right (R) of the CD player, and the other end to the CD, AUX, or TAPE PLAY input terminals, left (L) and right (R), of the amplifier.

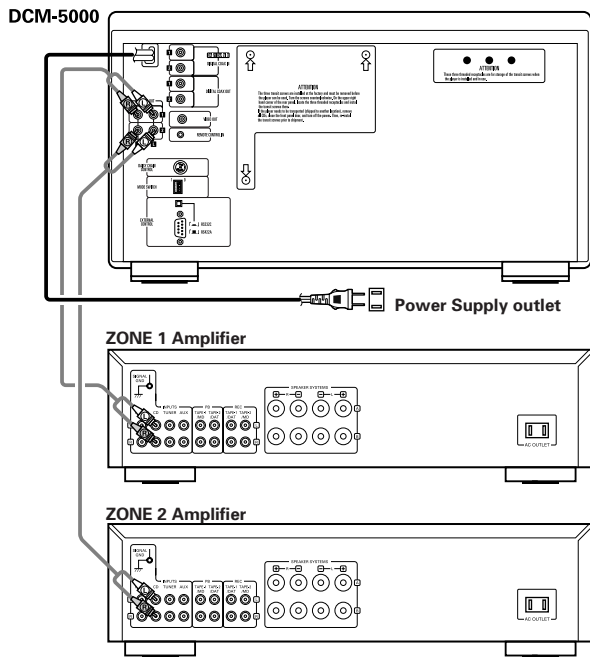

Connecting the Video Output Jack (VIDEO OUT)

When this is done, programs and disc files can be created and edited while watching the monitor TV screen.

Use a 75 Ω/ohms video coaxial pin cord to connect the video output jack (VIDEO OUT) of the DCM-5000 to the video input jack (VIDEO INPUT) on a TV's.

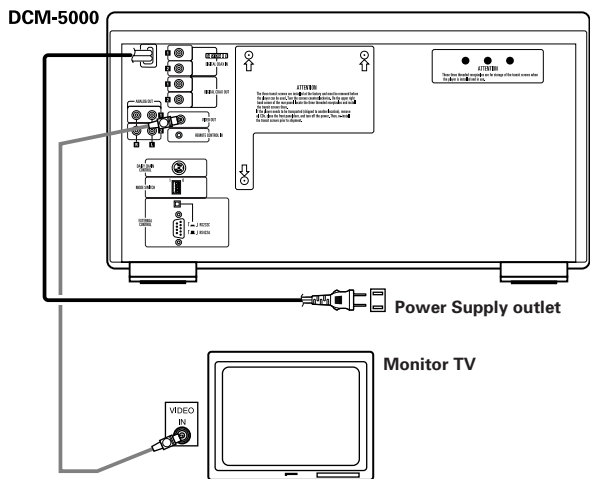

Connecting the Digital Output Jack (COAXIAL)

Use a 75 Ω/ohms coaxial pin cord to connect the digital output jack (DIGITAL COAX OUT) of the DCM-5000 to the digital input jack (COAXIAL) on a digital processor or D/A unit.

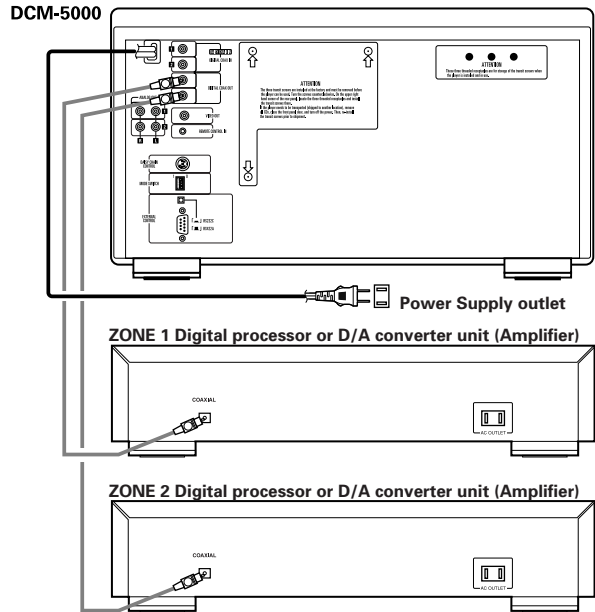

NOTE:

When the single zone mode is selected, no digital data is output from the ZONE 2 side.

Other Connections

Daisy chain connections

Up to five DCM-5001s (sold separately) can be connected to the DCM-5000, transforming the system into a CD changer with a maximum of 600 discs.

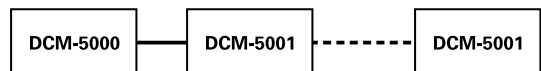

* For details on connections, refer to the DCM-5001's operating instructions.

Connecting a Keyboard

For faster and easier alpha-numeric text entry, an IBM compatible keyboard can be connected to the DCM-5000.

For details on connections, refer to "CONNECTING AND OPERATING A KEYBOARD" (page 37).

* The DCM-5000 is provided with computer and remote control interface ports, for compatibility with external remote control solutions offered by third party vendors. Contact your dealer or installation consultant for advice if you are considering the purchase of an external control system.

Loading CDs

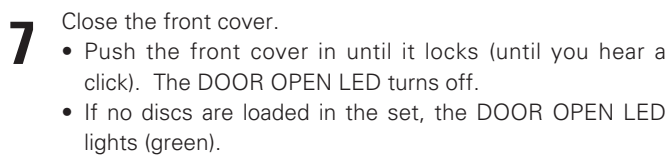
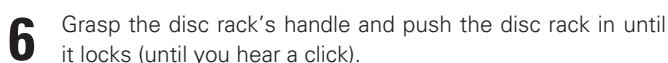
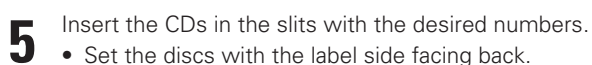
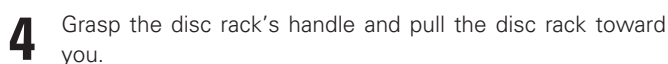
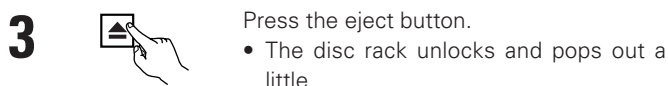
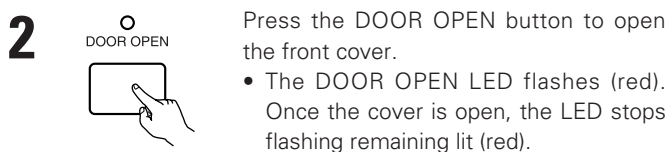
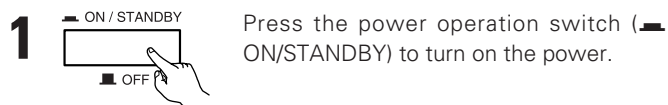

NOTES:

- Never put your hands or other objects inside the set when the front cover is open. Doing so may result in injury or damage.
 - Never place anything other than CDs on the disc rack. Doing so may result in damage.
 - If you drop a disc into the player or drop a disc from the disc rack inside the player, disconnect the power immediately and contact your store of purchase.
 - This model is for 12 cm CD. Do not insert an 8 cm CD nor 8 cm CD with an adaptor. It damages both the player and the disc.
 - When the door opens, the last play modes except for zone mode are cleared.
- ALL DISCS continuous mode is set after the door closes.

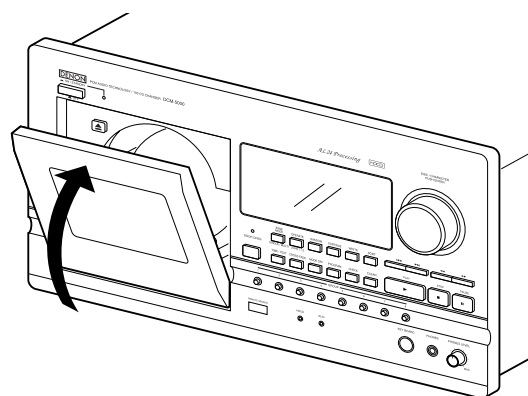
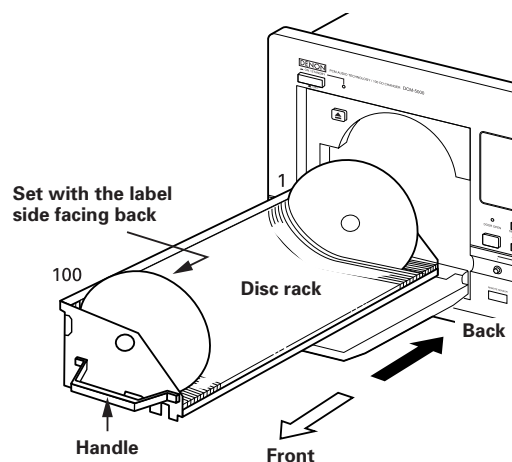
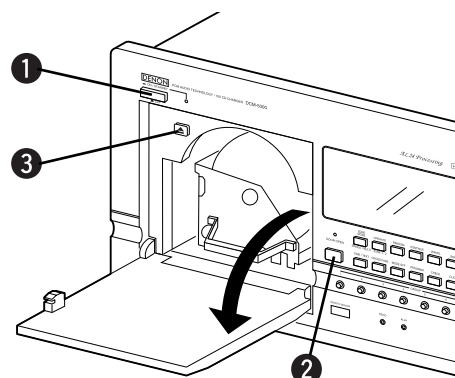

■ Booklet file

The liner notes or lyric cards for up to 100 CDs can be stored in the included booklet file.

We recommend attaching number stickers with the same numbers as the slits in which the discs are loaded to the booklet file's pockets.

600 number seals are provided for use should extra units be installed in a daisy chain.

■ Removing CDs

Following the procedure under "Loading CDs" to draw out the disc rack, then remove the CDs.

After removing the CDs, push the disc rack all the way in and close the front cover.

- * Always remove all the CDs when moving the player. If discs are loaded, shocks or vibrations may cause scratches or damage to the CDs or the internal mechanisms.

7 FLUORESCENT DISPLAY

The fluorescent display consists of the main display at the top and the sub display at the bottom. When in the multi-zone mode, the zone selected with the OPERATE button is displayed on the main display, and the various operations are only possible for the zone displayed on the main display.

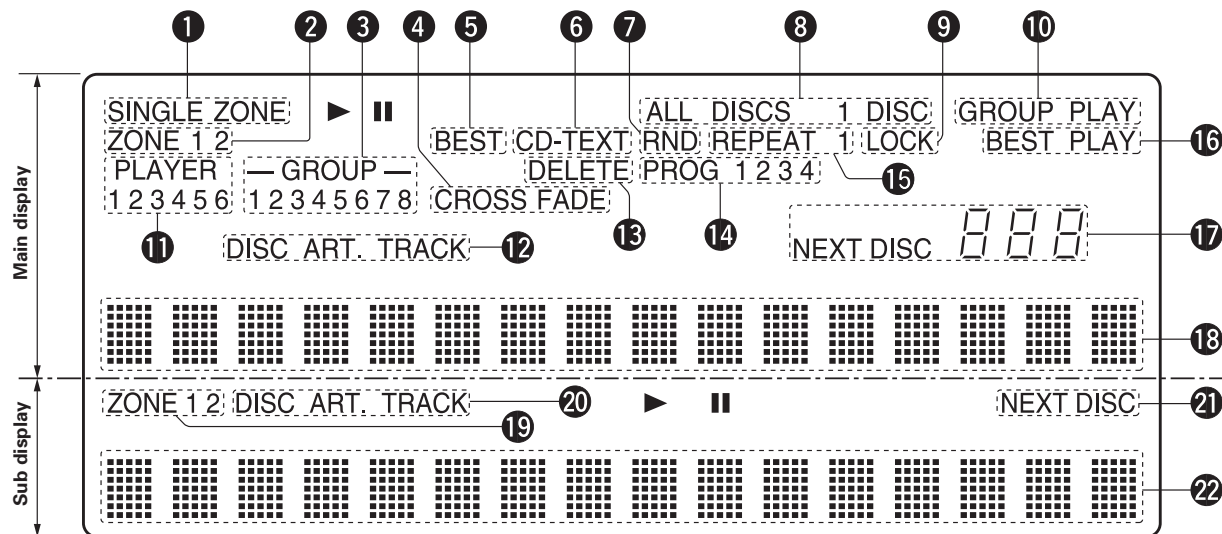

- 1 SINGLE ZONE**
This lights when in the single zone mode.
- 2 ZONE 1/ZONE 2**
These indicate the zone selected with the OPERATE button when in the multi-zone mode.
- 3 GROUP 1 to 8**
The group number registered on the CD being played lights. Only selected group number lights in the group play mode.
- 4 CROSS FADE**
This lights when the cross fade play mode is selected.
- 5 BEST**
This lights when the track being played is registered as a best hit.
- 6 CD TEXT**
This lights when the CD being played is a CD Text disc.
- 7 RND**
This lights in the random play mode.
- 8 ALL DISCS/1 DISC**
These light in the continuous play mode, the random play mode and the group play mode.
ALL DISCS: All the CDs are played according to the selected mode.
1 DISC: Only the selected CD is played.
- 9 LOCK**
This lights when the player is being controlled by external PC control. In this case, none of the buttons on the main unit or the remote control unit other than the DOOR OPEN button will operate.
- 10 GROUP PLAY**
This lights in the group play mode.
- 11 PLAYER 1 to 6**
These indicate the numbers of the players connected in a daisy chain.
- 12 DISC/ART./TRACK**
These indicate what is displayed on the character display below the indicators.
DISC: The CD number or disc title is displayed.
ART.: The artist's name is displayed.
TRACK: The track number or track title is displayed.
- 13 DELETE**
This lights when playing CDs containing deleted tracks.
- 14 PROG 1 to 4**
These indicate the applicable program when in the programmed play mode.
- 15 REPEAT/REPEAT 1**
These light in the repeat play mode according to the currently set play mode.
- 16 BEST PLAY**
This lights in the best play mode.
- 17 NEXT DISC**
In the all discs mode, the number of the CD to be played next on the main zone side is displayed here.
- 18 MAIN ZONE CHARACTER DISPLAY**
 - In the single zone mode, the disc title is displayed here.
 - In the multi-zone mode, the display depends on the display mode, as follows:
TEXT mode: The disc and track titles are displayed.
TIME mode: The disc number, track number and elapsed time are displayed.
- 19 ZONE 1/ZONE 2**
These indicate the sub zone (the zone not selected with the OPERATE button) when in the multi-zone mode.
- 20 DISC/ART./TRACK**
These indicate what is displayed on the character display below the indicators.
- 21 NEXT DISC**
This lights when the number of the CD to be played next is displayed on the sub zone side. The number of the CD is displayed on the character display below the indicator.
- 22 SUB ZONE CHARACTER DISPLAY**
The display depends on the display mode, as follows:
 - In the single zone mode:
TEXT mode: The track title or artist's name is displayed.
TIME mode: The disc number, track number and elapsed time are displayed.
 - In the multi-zone mode:
TEXT mode: The disc and track titles are displayed.
TIME mode: The disc number, track number and elapsed time are displayed.

8 NORMAL PLAYBACK

Before Starting

1 Refer to "CONNECTIONS" (page 7) and check that all connections are proper.

2 Press the power operation switch (ON/STANDBY) to turn the power on.

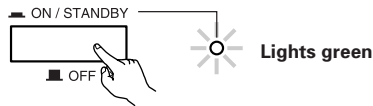

ON/STANDBY:

- When the button is pressed, the power turns on and the power LED lights. When on (when the LED is lit green): The DCM-5000 can be operated from either the main unit or the remote control unit. The standby mode is set (the LED lights red) when the STANDBY button on the remote control unit is pressed and the operation is terminated.
- In the standby mode (LED lit red): The power turns on (the LED lights green) when the POWER ON button on the remote control unit is pressed. (The player is set to the last play modes)

OFF:

- When the button is pressed while the power is on, the power turns off and the power LED also turns off.
- * When the power is off, the DCM-5000 cannot be operated from the remote control unit.

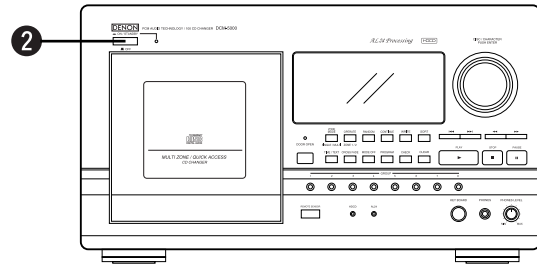

Zone modes

The DCM-5000 has two sets of outputs (zone 1 and zone 2), and different playback signals can be output from each zone. Select the zone mode before starting playback.

SINGLE: The same signals are output from zone 1 and zone 2.

MULTI: Separate playback signals are output from zone 1 and zone 2.

Play modes

The DCM-5000 has two play modes, the ALL DISCS and the 1 DISC modes. Select the play mode before starting playback.

ALL DISCS: All the CDs are played continuously.

1 DISC: Only the selected CD is played.

Playing CDs

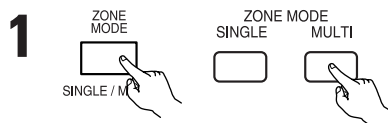
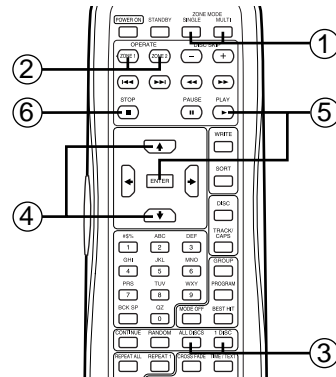
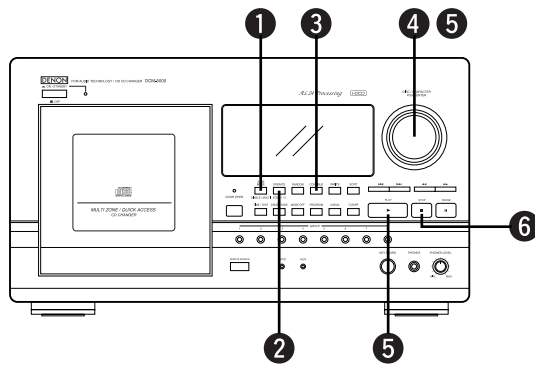

Press the ZONE MODE button to select the zone mode (SINGLE or MULTI).

* This operation is valid when the each zone is in the stop condition.

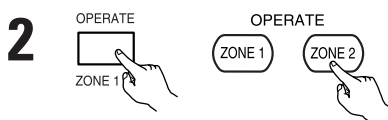

If the multi-zone mode is selected, press the OPERATE button to select the zone to be played (zone 1 or zone 2).

• The play mode can be set and CDs selected for the play zone displayed on the main display.

* **This operation is not necessary when the single zone mode is selected.**

3 CONTINUE ALL DISCS 1 DISC Press the CONTINUE button (on the remote control unit press the ALL DISCS or 1 DISC button) to select the play mode.

4 DISC / CHARACTER PUSH ENTER Turn the jog dial (on the remote control unit press the ↑ or ↓ button) to select the CD to be played.
 * It is also possible to select CDs by inputting the disc number. (Refer to page 14.)
 * When in the multi zone mode, it is not possible to specify the discs that are used or reserved for a next disc in the other zone. This applies to all kind of play modes.

5 PLAY PLAY Press the PLAY button or the jog dial (on the remote control unit press the PLAY or ENTER button) to start playback.
 * If the multi-zone mode is selected, repeat the above operations from step 3 for the other zone.

6 STOP STOP To stop playback, press the STOP button.

Other Operations

When you want to:	Press:
Pause playback:	⏸ (pause)
Resume playback:	▶
Proceed to the next CD (remote control unit only):	DISC SKIP +
Return to the previous CD (remote control unit only):	DISC SKIP -
Proceed to the next track:	⏭
Return to the previous track:	⏮
Manual search reverse:	⏪
Manual search forward:	⏩

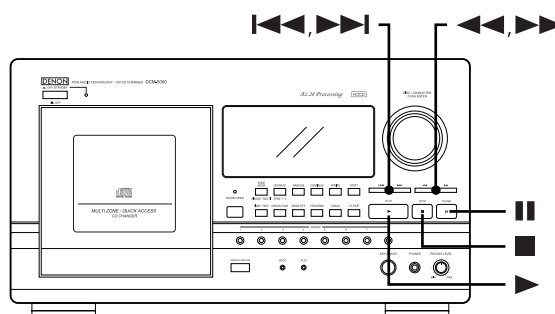

Selecting the Next CD to be Played During Playback

In the ALL DISCS CONTINUOUS mode, it is possible to select the CD to be played next during playback.

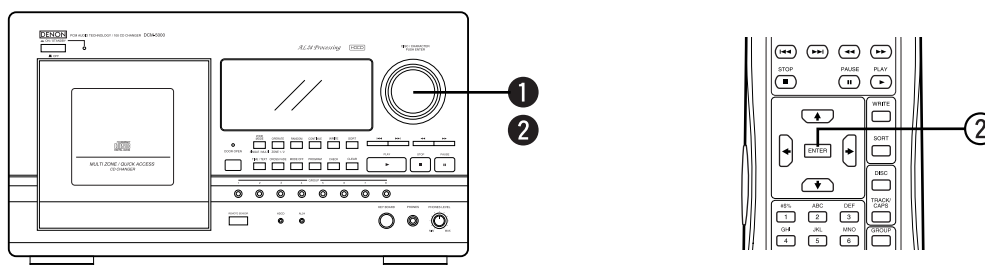

1 DISC / CHARACTER PUSH ENTER Turn the jog dial and select the CD to be played.
 • Playback of the selected CD starts when the currently playing CD ends.

2 DISC / CHARACTER PUSH ENTER Press the ENTER button to stop the currently playing CD and play the selected CD.

Using the Sort Function

There are three sort functions for searching for the desired CD.

- ① **SORT/DISC NO.:** Use this function to search for discs in the order of the disc numbers.
- ② **SORT/DISC ABC:** Use this function to search for discs in the order of the disc titles (in alphabetical order).
- ③ **SORT/ARTIST:** Use this function to search for discs in the order of the artist names (in alphabetical order).

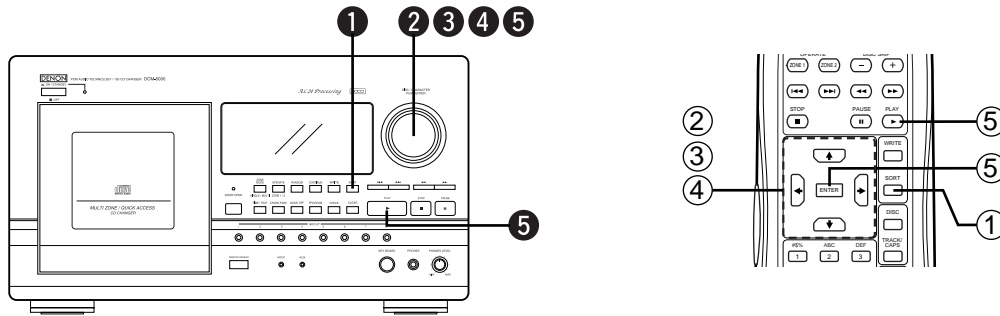

1

Press the SORT button to display the desired sort mode.

- The mode switches as follows each time the button is pressed.
 - SORT/DISC NO.: Perform step 2 below.
 - SORT/DISC ABC: Perform step 3 below.
 - SORT/ARTIST: Perform step 4 below.
- If the PLAY button is pressed directly after pressing the SORT button during playback, the playback display reappears.

2

To select CDs by disc number:

Turn the jog dial (on the remote control unit press the ↑ or ↓ button) to select the CD to be played.

- * When the ← or → button on the remote control unit is pressed, the disc number skips forward or backward by 10 numbers.
- * To start playback, proceed to step 5.

3

To select CDs by disc title:

When SORT/DISC ABC is selected, the disc whose title begins with the specified character is displayed. Use the ← and → buttons to change the first character in alphabetical order.

4

Turn the jog dial (on the remote control unit press the ↑ or ↓ button) to select the desired CD from among the disc titles starting with the selected character.

- * To start playback, proceed to step 5.

NOTE: Sorting by disc title and artist's name is case sensitive. Upper case "A" should be used for the first character of a disc name and/or artist's name.

4

To select discs by artist's name:

Press the ← or → button on the remote control unit and select the artist's name.

- The artist's names are displayed in alphabetical order.
- In case of the SORT/ARTIST in the multi zone mode, operate with checking the on-screen display.

4



Turn the jog dial (on the remote control unit press the ↑ or ↓ button) to select the desired CD from among the discs with the selected artist's name.

5

Press the PLAY button or the jog dial (on the remote control unit press the PLAY or ENTER button) to start playback.



Selecting CDs by Inputting the Disc Number

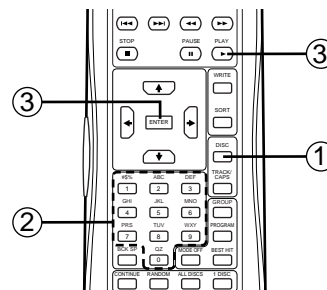

- 1**  Press the DISC button.
- 2** Use the number buttons to select the desired CD.
Example: To select disc number 23

- 3**  Press the PLAY or ENTER button to start playing the selected disc.



Selecting a Specific Track Directly

- 1**  Press the TRACK/CAPS button.
- 2**  Use the number buttons to select the desired track.
Example: To select track 3

* When monitoring the on-screen display, it is possible to select the track while checking the track titles. (Refer to page 34.)

 - Use the ↑ and ↓ buttons to select the desired track.
- 3**  Press the PLAY or ENTER button to start playing the selected track.

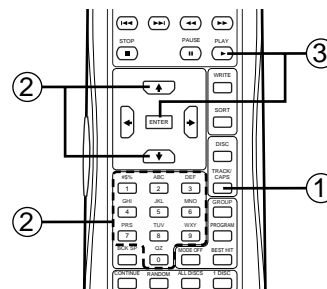

9 VARIOUS PLAYBACK FUNCTIONS

Playing Tracks in Random Order

Use this function to play the tracks on the CD in random order.

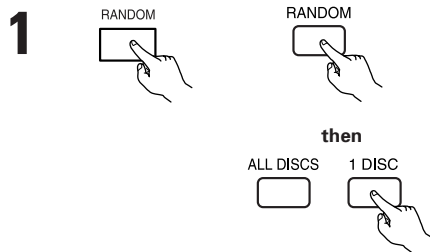
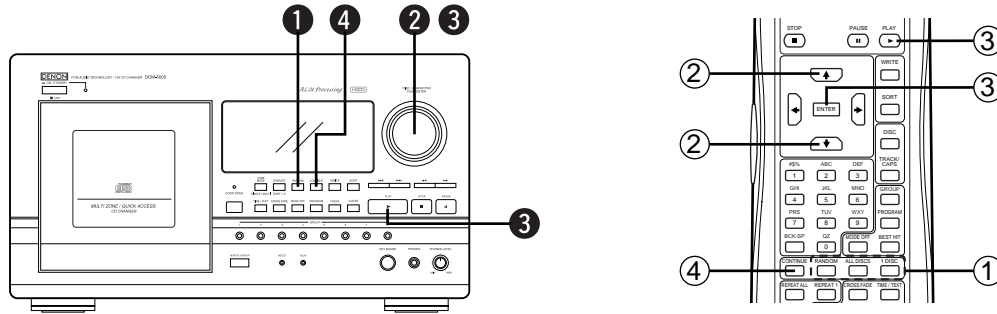

Press the **RANDOM** button (on the remote control unit press the **RANDOM** button, then press the **ALL DISCS** or **1 DISC** button) to select the play mode.

- The mode switches between **1 DISC** ↔ **ALL DISCS** each time the **RANDOM** button on the main unit is pressed.

ALL DISCS: All the CDs are played in random order.
One track is selected at random from each of the CDs.
1 DISC: The tracks on the selected CD are played in random order.

* **"RND"** appears on the display window when the random play mode is selected.

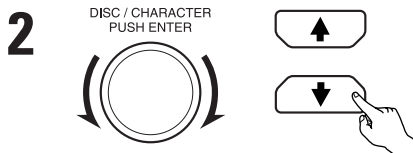

In the **1 DISC** mode, turn the jog dial (on the remote control unit press the **↑** or **↓** button) to select the disc to be played.

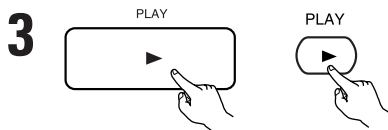

Press the **PLAY** button or the jog dial (on the remote control unit press the **PLAY** or **ENTER** button) to start random playback.

- To go to the next random track: Press **▶▶|** button during playback.

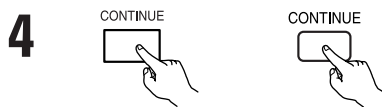

Press the **CONTINUE** button to cancel random playback.

- If the **RANDOM** button is pressed during playback in the continuous mode, the random play mode is set.
- If the **RANDOM** button on the main unit is pressed during random playback, the random mode switches (between **1 DISC** ↔ **ALL DISCS**).
- If the **1 DISC** or **ALL DISCS** button on the remote control unit is pressed during random playback, the random mode switches.
- Random playback is also available in Group play mode (**ALL DISCS Random**) and **Best Hit** play mode.
- You cannot use Sort function in the **ALL DISCS Random** mode.

Playing Repeatedly

[This operation is only possible from the remote control unit]

When the all-repeat mode is selected, the discs are played as follows according to the set play mode.

- ① **ALL DISCS CONTINUOUS mode:** All the tracks on all the CDs are played repeatedly.
- ② **1 DISC CONTINUOUS mode:** All the tracks on the selected CD are played repeatedly.
- ③ **ALL DISCS RANDOM mode:** One track (selected randomly) on each CD is played repeatedly.
- ④ **1 DISC RANDOM mode:** All the tracks on the selected CD (current disc) are played repeatedly in random order.
- ⑤ **PROGRAM mode & BEST HIT PLAY mode:** The program is played repeatedly.

- 1 **REPEAT ALL** Press the REPEAT ALL button.
* "REPEAT" appears on the display.
- 2 **REPEAT OFF** Press the REPEAT OFF button to cancel repeat playback.

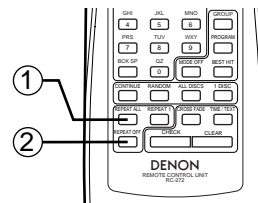

- If the REPEAT ALL button is pressed during playback, the mode switches to the all repeat play mode.
- If the REPEAT ALL button is pressed during playback in the repeat 1 play mode, the mode switches to the all repeat play mode.

Playing a Single Track Repeatedly

[This operation is only possible from the remote control unit]

- 1 **REPEAT 1** Press the REPEAT 1 button.
* "REPEAT 1" appears on the display.
- 2 **REPEAT OFF** Press the REPEAT OFF button to cancel repeat playback.

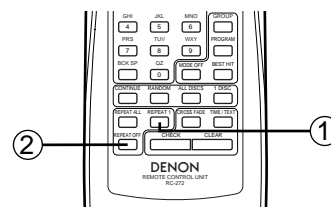

- If the REPEAT 1 button is pressed during playback, the mode switches to the single track repeat play mode.
- If the REPEAT 1 button is pressed during playback in the all repeat play mode, the mode switches to the single track repeat play mode.

Cross Fade Playback

The cross fade play function can only be used in the single zone mode.

The cross fade mode allows you to play tracks continuously without breaks in the sound by fading in and out when switching from playback on one disc to a track on the next disc.

Random modes are automatically selected in the Cross fade playback, as described on the table below.

<p>ALL DISCS Random mode:</p>	<p>Cross fade playback is performed between tracks on discs selected at random (one track per disc). Order of playback: Disc 3, Tr 5 ⇨ Disc 18, Tr 1 ⇨ Disc 56 Tr 3 ⇨ Disc 29, Tr 4 ⇨ ...</p>
<p>Group Random mode:</p>	<p>Cross fade playback is performed between tracks on discs selected at random within the selected group (one track per disc). Order of playback: Disc 3, Tr 5 ⇨ Disc 18, Tr 1 ⇨ Disc 56 Tr 3 ⇨ Disc 29, Tr 4 ⇨ ...</p>

* "ALL DISCS", "Random", and "REPEAT" are always selected in the cross fade mode.

1 In the stop mode, press the CROSS FADE button.

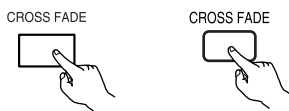

2 To play groups, press the GROUP button and select the group to be played.

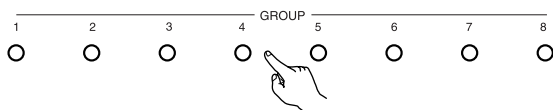

To select on the remote control unit:



Example: To select group 3

To cancel the group mode in the cross fade mode, press the MODE OFF button while in the stop mode.

3 Press the PLAY button to start cross fade playback.

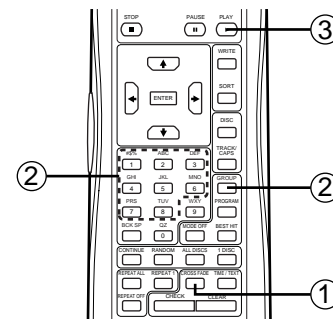
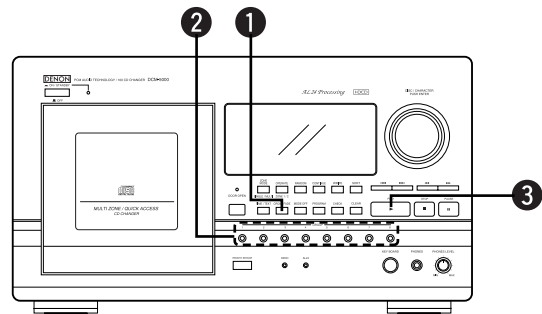
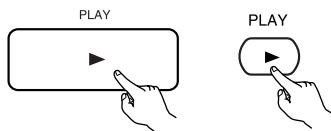

■ To cancel the cross fade mode, first stop playback then press the CROSS FADE button. ("Random", "Repeat" are also canceled)

NOTES:

- No signals are output from the digital outputs when the cross fade mode is selected.
- AL24 processing and HDCD are both disabled when the cross fade mode is selected.
- To enter into the CROSS FADE mode from Program or Best hit play mode:
 First press MODE OFF button in the stop mode, then press CROSS FADE button. (Program or Best hit play mode is canceled)



10 PROGRAMMED PLAYBACK

This function allows you to choose the desired CDs or tracks and play them in the programmed order.

For types of programs can be set for zone 1, four more programs for zone 2, and four more programs for the single zone mode. Up to 40 steps can be set in each program.

A single track or all the tracks on a single disc can be set for one step.

It is possible to set the program either during playback and stop mode.

In the program mode, deleted tracks (refer to page 29) are skipped during playback.

Programming

[Programming from the main unit]

1  Press the PROGRAM button and select the desired program number.

* The program number and the display switch each time the PROGRAM button is pressed.

"PROG 1" → "PROG 2" → "PROG 3" → "PROG 4"

* If there are already entries at the selected program number, the disc number, track number, and step number for the first step in the program appear on the display.

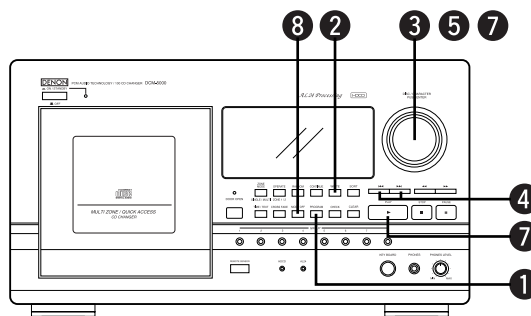

Example of display: When a program number that already has entries is selected in the multi-zone mode:



* If a program number with no entries is selected, "NO ENTRY" is displayed after "PROGRAM *".

* If a program number that already has entries is selected during playback, programmed playback starts after "PROGRAM *" is displayed and the display returns to the play mode display.

2  Press the WRITE button.

- The programming mode is set.
- * The programming mode is canceled if the WRITE button is pressed again.



The current disc number is indicated in the disc number section and the number of the step to be programmed flashes in the step number section.

3  Turn the jog dial to select the desired CD.

- * To program all the tracks on the CD, proceed to step 5.

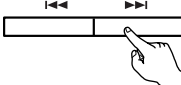

When disc number 6 is selected.

4  Use the **◀◀** and **▶▶** buttons to select the desired track.



When track number 7 is selected.

5  Press the jog dial.

- The selected CD (or track) is stored in the program.

6 To continue programming other CDs or tracks, repeat steps 2 to 5 above.

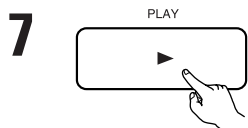

Press the PLAY button or the jog dial to start program playback.

* The step in the program (disc, track) that are not found in the player or being used in the other zone, are skipped during playback.

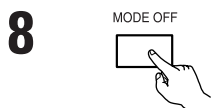

To cancel the program mode, press the MODE OFF button.

[Programming from the remote control unit]

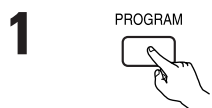

Press the PROGRAM button.

* "PROGRAM-_" appears on the display.

2 Use number buttons 1 to 4 to select the desired program number.

Example: To select program number 1



* If a program number that already has entries is selected during playback, programmed playback starts after "PROGRAM *" is displayed and the display returns to the play mode display.

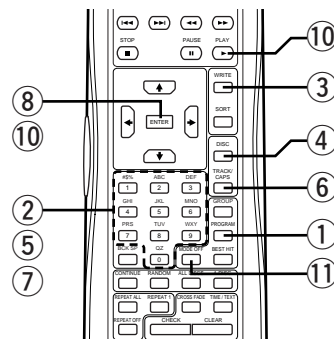

Press the WRITE button.

• The programming mode is set.

* The programming mode is canceled if the WRITE button is pressed again.



The current disc number is indicated in the disc number section and the number of the step to be programmed flashes in the step number section.

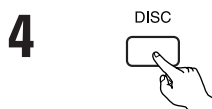

Press the DISC button.

5 Use the number buttons to select the desired CD.

Example: To select disc number 6



When disc number 6 is selected.

* To program all the tracks on the CD, proceed to step 8.



Press the TRACK/CAPS button.

7 Use the number buttons to select the desired track.

Example: To select track number 7



When track number 7 is selected.



Press the ENTER button.

- The selected CD (or track) is stored in the program.

9 To continue programming other CDs or tracks, repeat steps 3 to 8 above.

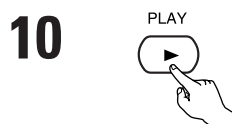

Press the PLAY or ENTER button to start program playback.

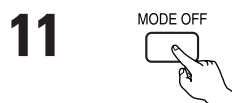

To cancel the program mode, press the MODE OFF button.

Checking the Programs

Use this function to check the programmed CDs or tracks before or during playback.

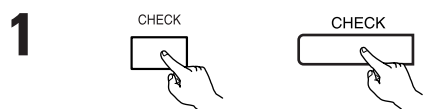
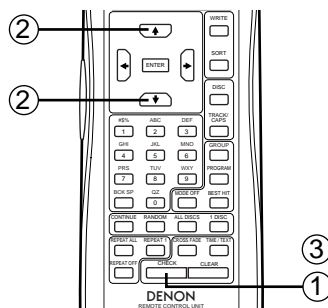
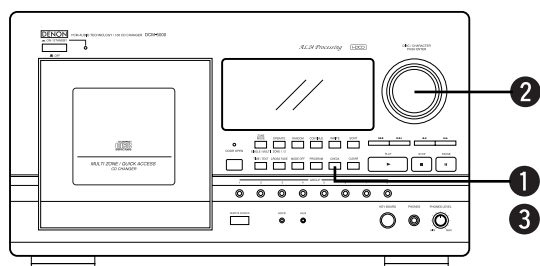

Press the CHECK button while in the program mode.



* There is no need to do this when in the stop mode.

During playback, the number of the currently playing step is displayed.



Turn the jog dial (or on the remote control unit use the ↑ or ↓ button) to move forward (backward) through the program and check its contents.

* "PROGRAM * END" is displayed if the jog dial is turned clockwise (or on the remote control unit if the ↓ button is pressed) from the last step.

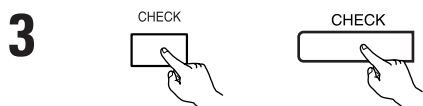

To stop checking the program, press the CHECK button again.

* There is no need to do this when in the stop mode.

Clearing Programs

Programs can be cleared while stopped in the program mode.

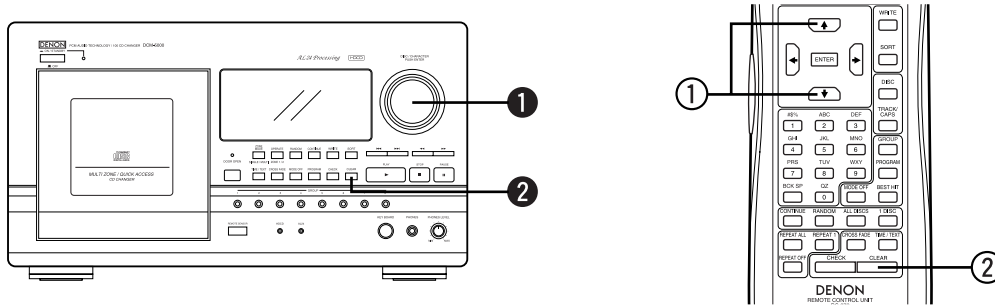

■ Clearing CDs (or tracks) in the middle of a program

1 Turn the jog dial (on the remote control unit press the ↑ or ↓ button) to move forward (or backward) and display the step to be cleared.

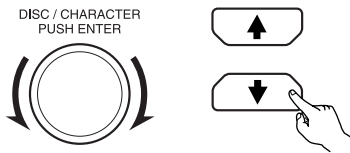

```

ZONE 1          PROGRAM
PLAYER          1
1
DISC    TRACK          DISC    6
 6      7  STEP 5
    
```

2 Press the CLEAR button.

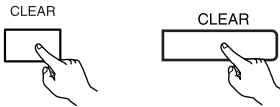

- The entry for the displayed step number is cleared and the first step is displayed.

```

ZONE 1          PROGRAM
PLAYER          1
1
DISC    TRACK          DISC    27
27     6  STEP 1
    
```

* If CLEAR is pressed without performing the operation in step 1, the first step is cleared.

■ Clearing the entire current program

1 Select the program number.
(Refer to pages 18 and 19.)

```

ZONE 1          PROGRAM
PLAYER          1
1
DISC    TRACK          DISC    27
27     6  STEP 1
    
```

2 Press the CLEAR button continuously until "ALL CLEAR" is displayed.

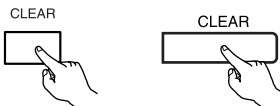

- The entire current program is cleared and "NO ENTRY" appears on the display.

```

ZONE 1          PROGRAM
PLAYER          1
1
DISC    TRACK          DISC
NO ENTRY
    
```

Adding to the end of programs.

Follow steps 2 to 5 under "Programming from the main unit" (page 18) or steps 3 to 8 under "Programming from the remote control unit" (page 18) to add CDs (or tracks) to the end of the program.

11 USING DISC FILES

About Disc Files

With disc files, disc titles, artists' names and track titles can be given for individual CDs and the discs can be categorized in groups. Each disc can be labeled up to 30 tracks. Titles can have up to 16 characters. Disc files are stored in the memory even when the power is off.

NOTES:

- Disc files are stored for the discs' slit numbers, so they remain in the memory even when the CDs have been replaced. Before replacing CDs, erase all the disc files one by one in order, then create new disc files for the new CDs.
- CD Text discs have various types of text information (disc title, artist name, etc.) stored on them. This information is automatically stored in a disc file when the CD is played, and cannot be changed. CD Text discs can however be registered in groups like other CDs.
- It is not possible to set the disc file writing mode while in the multi-zone or random mode.

Writing Disc Files

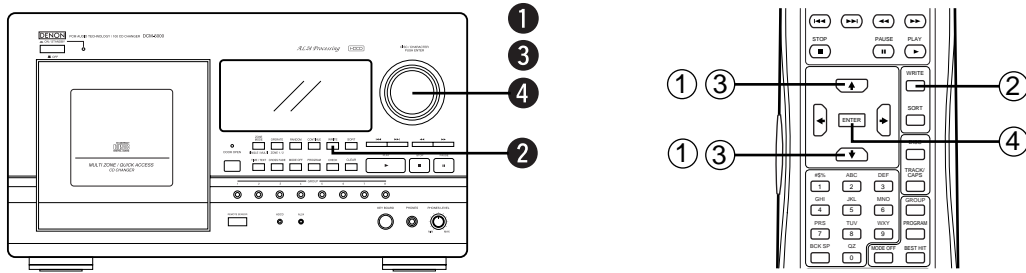

1 DISC / CHARACTER PUSH ENTER  Turn the jog dial (on the remote control unit press the ↑ or ↓ button) and select the disc for which you want to create a disc file.



* It is also possible to select CDs by inputting the disc number. (Refer to page 14.)

2 WRITE  Press the WRITE button.



* If the WRITE button is pressed again, the disc file writing mode is canceled and the player returns to the previous mode.



3 DISC / CHARACTER PUSH ENTER  Turn the jog dial (on the remote control unit press the ↑ or ↓ button) to display the disc file items.

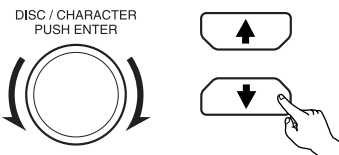

DISC NAME ↔ ARTIST NAME ↔ GROUP FILE ↔ TRACK 1 ↔ ...

* Track titles can be stored for up to 30 tracks.

4 DISC / CHARACTER PUSH ENTER  Press the jog dial (on the remote control unit press the ENTER button) to set the character input mode.

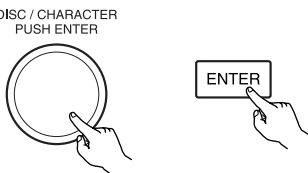

When inputting a disc name:

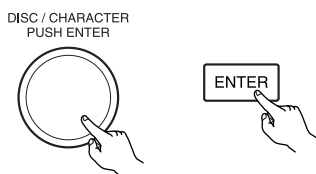

When the artist's name is selected, press the jog dial again. (On the remote control unit press the ENTER button again.)



[Inputting characters from the main unit]

5 Turn the jog dial to select the first character (letter, number or symbol).



When the jog dial is turned clockwise, the characters (letters, numbers or symbols) change as shown below. When turned counterclockwise, the characters change in the opposite order.

```
(space) ABCDEFGHIJKLMNOPQRSTUVWXYZ
abcdefghijklmnopqrstuvwxyz
0123456789
! " # $ % & ' ( ) * + , - . / : ; < = > ? @ [ \ ] ^ _ ` { | } ~
```

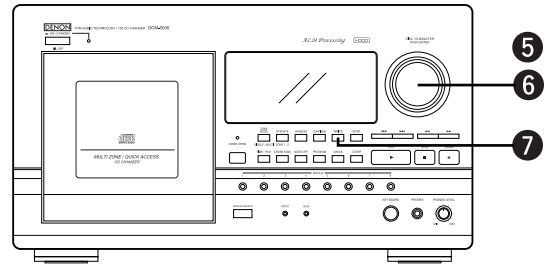

6 Press the jog dial.
 • The character is entered and the cursor (flashing) moves to the right.

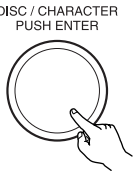

* To input other characters, repeat steps 5 and 6.
 If you make a mistake, press the CLEAR button then start over from the beginning.
 To move to another item (for example to input the artist's name after inputting the disc name), press the ENTER button again to return to step 3.

7 Press the WRITE button to cancel the disc file writing mode and return to the previous mode.

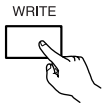

[Inputting characters from the remote control unit]

8 Press the TRACK/CAPS button to select the type of character (capital letter, small letter, number or symbol).



The cursor changes each time the button is pressed to indicate a different character type.

Capital letters: █ flashing
 Small letters: █ flashing
 Numbers: █ flashing

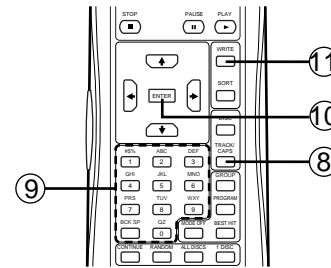

9 Use the number buttons to select the desired character (letter, number or symbol).

Example: To select C

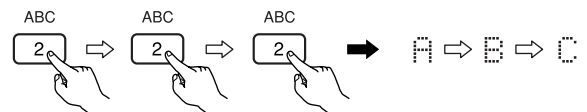

10 Press the ENTER button.
 • The character is entered and the cursor (flashing) moves to the right.



* To input other characters, repeat steps 8 to 10.
 If you make a mistake, press the BCK SP (back space) button then input the correct character. (Refer to page 24.)
 If the CLEAR button is pressed, all of the input characters are cleared, so start over from step 5 or 8.
 To move to another item (for example to input the artist's name after inputting the disc name), press the ENTER button again to return to step 3.

11



Press the WRITE button to cancel the disc file writing mode and return to the previous mode.

[Correcting characters]

12

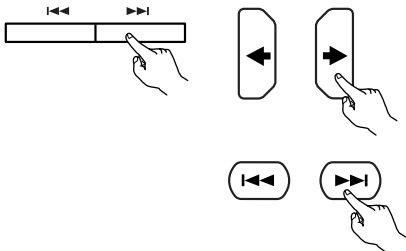

Press the ◀◀ or ▶▶ button (or the ← or → button on the remote control unit) to move the cursor (flashing) to the right of the character to be corrected.

DENI █ CD

13



Press the BCK SP button.
 • The character to the left of the cursor (flashing) is cleared.

DEN █ CD

14

Repeat steps 8 to 10 to input the correct character.

Select the character.

Press the ENTER button.

DEN █ CD ⇒ DENON █ CD

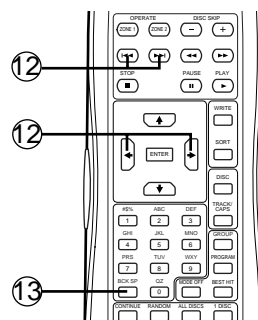
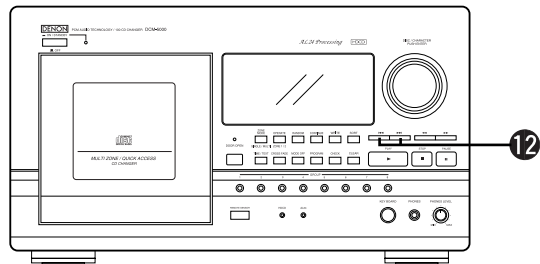

■ You can select the artist's name without inputting characters

At step 4 (on page 22) when the "NO FILED NAME" flashes, as you turn the jog dial (on the remote control unit use ← and → buttons), the display shows the artist's names registered for other discs. Press ENTER to select the artist's name for the current disc.

Clearing Disc Files

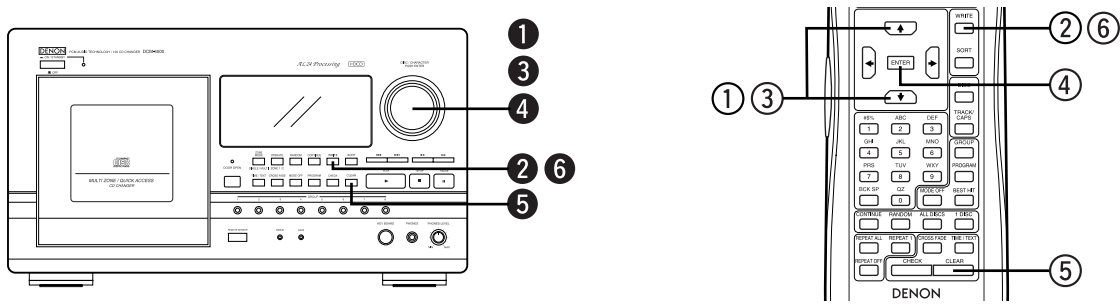

1 DISC / CHARACTER PUSH ENTER

Turn the jog dial (on the remote control unit press the ↑ or ↓ button) to select the CD whose disc file you want to clear.

*** It is also possible to select CDs by inputting the disc number. (Refer to page 14.)**

2 WRITE

Press the WRITE button.

*** If the WRITE button is pressed again, the disc file writing mode is canceled and the player returns to the previous mode.**

3 DISC / CHARACTER PUSH ENTER

Turn the jog dial (on the remote control unit press the ↑ or ↓ button) to display the disc item you want to clear.

DISC NAME ↔ ARTIST NAME ↔ GROUP FILE ↔ TRACK 1 ↔ ...

4 Press the jog dial (on the remote control unit press the ENTER button).

*** For the artist's name, press the ENTER button again.**

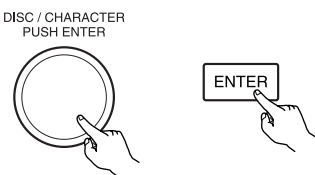

5 Press the CLEAR button.

*** The item selected in step 3 is cleared.**

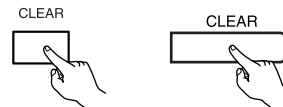

6 Press the WRITE button, to return to the previous mode.



■ Clearing all the player's disc files (disc titles, artists' names, track titles and group files) (This operation is only possible from the main unit.)

1. Press the power operation switch while holding in the WRITE and CLEAR buttons to turn on the power.
2. "ALL ERASE" is displayed. (release the WRITE and CLEAR buttons)
When "ALL ERASE" turns off, all the disc files are erased.
No buttons will work until "ALL ERASE" turns off. The greater the number of discs whose disc files are to be erased, the longer it takes for the disc files to be erased.
 - When players are connected in daisy chain, all the files in the connected players are erased.

■ Clearing all the disc files for one CD (This operation is only possible from the main unit.)

1. Select the disc whose disc files you want to erase.
2. Press the WRITE button to set the write mode.
3. Press the CLEAR button while pressing in the CHECK button until "FILE ERASED" is displayed.
The disc files for the selected CD are erased and the disc file writing mode is set.

Categorizing CDs in groups

■ Registering CDs in groups

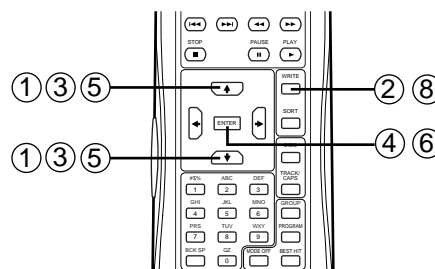
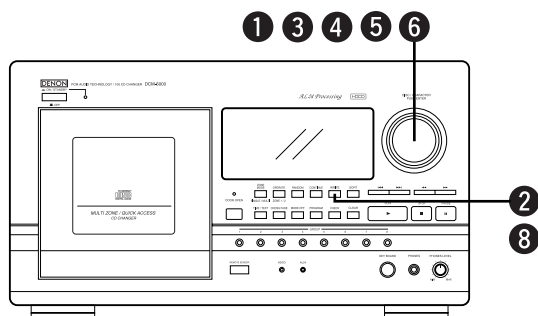

1 DISC / CHARACTER PUSH ENTER

Turn the jog dial (on the remote control unit press the ↑ or ↓ button) to select the CD you want to register in groups.

*** It is also possible to select CDs by inputting the disc number. (Refer to page 14.)**

2 WRITE

Press the WRITE button.

*** If the WRITE button is pressed again, the disc file writing mode is canceled and the player returns to the previous mode.**

3 DISC / CHARACTER PUSH ENTER

Turn the jog dial (on the remote control unit press the ↑ or ↓ button) to display "GROUP FILE".

4 DISC / CHARACTER PUSH ENTER

Press the jog dial (on the remote control unit press the ENTER button).

5 DISC / CHARACTER PUSH ENTER

Turn the jog dial (on the remote control unit press the ↑ or ↓ button) to display the desired group.

When no group has been registered:

6 DISC / CHARACTER PUSH ENTER

Press the jog dial (on the remote control unit press the ENTER button).

- The group name input mode is set.

7 Enter the group name.
 Enter the group name following "Inputting characters from the main unit" (page 23) steps 5 and 6 or "Inputting characters from the remote control unit" (page 23) steps 8 to 10.

*** One CD can be registered in up to four groups. To register a CD in multiple groups, repeat steps 5 to 7.**

8 WRITE

Press the WRITE button.

- The disc file writing mode is canceled and the player returns to the previous mode.

■ Clearing CDs from groups

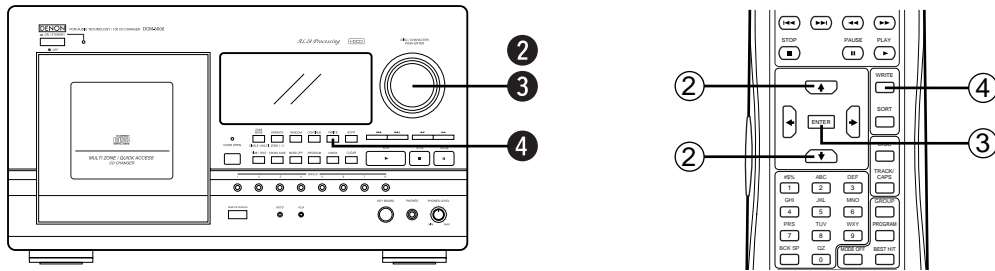

1 Follow steps 1 to 4 under "Registering CDs in groups" (page 26) to display the group name.

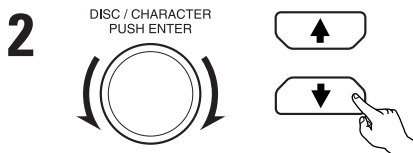

Turn the jog dial (on the remote control press the ↑ or ↓ button) to display the desired group.

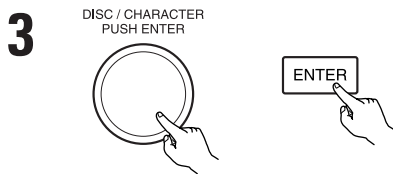

Press the jog dial (on the remote control press the ENTER button). The CD is cleared from the displayed group.

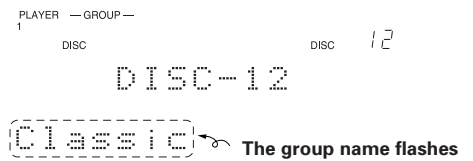

* To clear the CD from other groups, repeat steps 2 and 3.

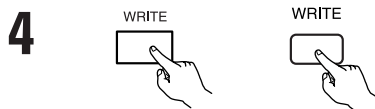

Press the WRITE button.
 • The disc file writing mode is canceled and the player returns to the previous mode.

■ Clearing the current disc from all the groups in which it is registered

At step 2 above, display "NO GROUP", then press the ENTER button to clear the disc from all the groups at once.

■ Clearing group names

NOTE: Group names can only be cleared if CDs are registered in the group.

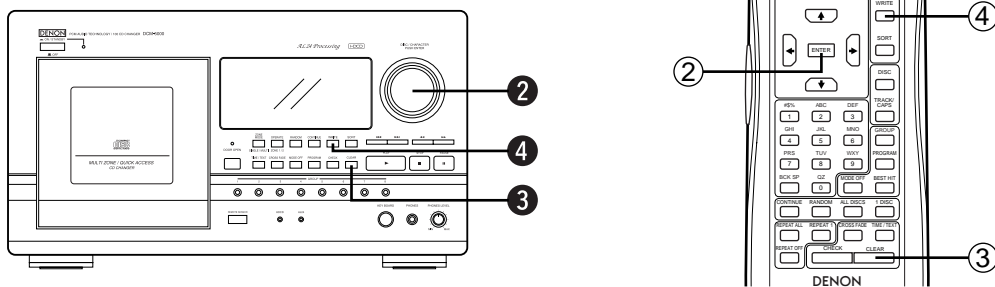

1 Follow steps 1 to 5 under "Registering CDs in groups" (page 26) to display the group name.

2 Press the jog dial (on the remote control press the ENTER button).

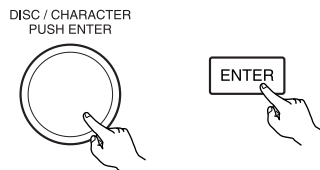

3 Press the CLEAR button.

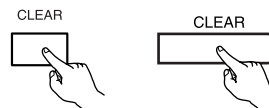

4 Press the WRITE button.
 • The disc file writing mode is canceled and the player returns to the previous mode.



Playing Groups

When the group play mode is selected, the discs are played as follows according to the set play mode:

- ① **All DISCS CONTINUOUS mode:** All the CDs in the group are played continuously.
- ② **All DISCS RANDOM mode:** One track (selected randomly) on each CD in the group are played in random order.

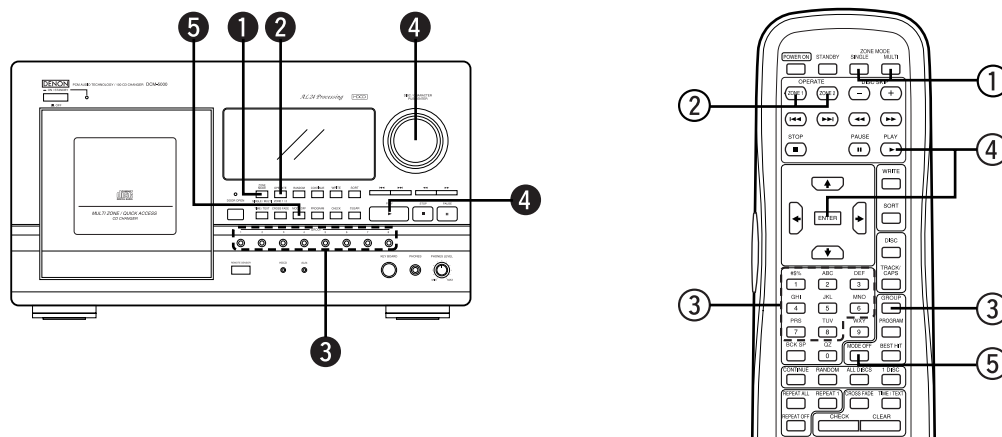

1 Press the ZONE MODE button and select the zone mode (SINGLE or MULTI).

2 When the multi-zone mode is selected, press the OPERATE button to select the zone to be played (zone 1 or zone 2).
 • The play mode can be set and CDs selected for the play zone displayed on the main display.

*** This operation is not necessary when the single zone mode is selected.**

3 Press the GROUP button and select the group to be played.

[Selecting the group from the remote control unit]

Press the GROUP button, then press the DEF number button to select the desired group.

Example: When group 3 is selected

4 Press the PLAY button or the jog dial (on the remote control unit press the PLAY or ENTER button) to start playback from the CD with the lowest number within the group list.
 ■ To specify the disc from which playback is to start, select the disc on the main unit or the remote control unit.

*** If the multi-zone mode is selected, repeat the above operations from step 2 for the other zone. In this case it is not possible to play the same group.**

5 To cancel group playback, press the MODE OFF button.



Using the Delete File Function

■ Delete File function

This function can be used to delete certain tracks from a disc and only play the desired tracks. When that disc is played, the deleted tracks are skipped.

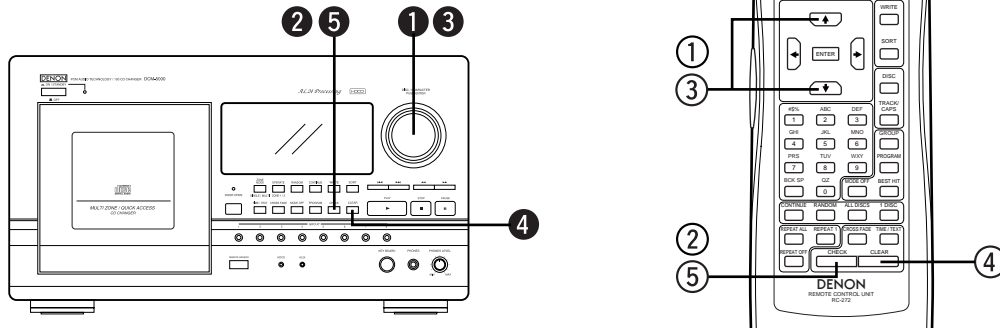
- Up to 100 tracks can be deleted for each of zone 1, zone 2 and the single zone modes.





1 DISC / CHARACTER PUSH ENTER   Turn the jog dial (on the remote control unit press the ↑ or ↓ button) to select the CD for which you want to create a delete file.

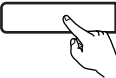

* It is also possible to select CDs by inputting the disc number. (Refer to page 14.)

2 CHECK   Press the CHECK button.

PLAYER 1
DISC DISC 12
DISC-12
DISC TRACK
12 1 SELECTED

3 DISC / CHARACTER PUSH ENTER   Turn the jog dial (on the remote control unit press the ↑ or ↓ button) to select the track to be deleted.

PLAYER 1
DISC DISC 12
DISC-12
DISC TRACK
12 3 SELECTED

4 CLEAR   Press the CLEAR button to display "DELETED".

- The displayed track is stored in the delete file.

* To continue deleting other tracks, repeat steps 3 and 4.

PLAYER 1
DISC DISC 12
DISC-12
DISC TRACK
12 3 DELETED

■ Removing tracks from the delete file

Select (display) the track you want to remove from the delete file then press the CLEAR button. "DELETED" switches to "SELECTED" and that track is no longer deleted.

■ Removing all the tracks from the delete file at once

Press the CLEAR button until "ALL SELECTED" is displayed.

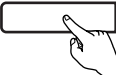
5 CHECK   Press the CHECK button to cancel the delete file mode and return to the previous mode.

12 BEST HIT PLAY MODE

About the best hit play mode

Use this function to make it easy to play CDs or tracks you listen to often.

One step in the best hit list consists of one track or all the tracks on one CD. Up to 100 steps can be stored for each of zone 1, zone 2 and the single zone modes.

In the best hit play mode, the discs are played in order starting from the lowest disc number.

Registering Best Hits

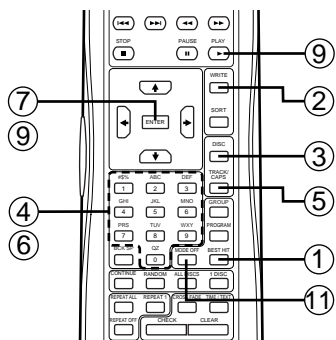

* Register tracks or CDs on the best hit list while in the stop mode. (not possible in the Random mode)



Press the BEST HIT button.

Display example: When there are already entries on the best hit list in the multi-zone mode.



* "NO ENTRY" is displayed after "BEST PLAY MODE" if a zone for which there are no entries is selected.

* If a zone for which there are entries is selected during playback, after "BEST PLAY MODE" is displayed the best hit play mode starts and the normal playback display reappears.

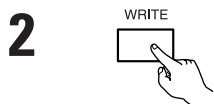

Press the WRITE button.

- The best hit input mode is set.



The current disc number is indicated in the disc number section and the number of the step to be written flashes in the step number section.

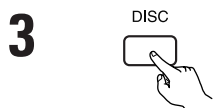

Press the DISC button.

4 Use the number buttons to select the desired disc.

Example: To select disc number 35



When disc number 35 is selected.

* To register all the tracks on the disc, proceed to step 7.



Press the TRACK/CAPS button.

6 Use the number buttons to select the desired track.

Example: To select track number 7



When track number 7 is selected.

7  Press the ENTER button.
 • The selected CD (or track) is registered.

8 Repeat steps 2 to 7 above to register more CDs or tracks on the best hit list.

9  Press the PLAY or ENTER button to start best hit playback.
 * The step in the Best Hit List (disc, track) that are not found in the player or being used in the other zone, are skipped during playback.

10  To cancel the best hit play mode, press the MODE OFF button.

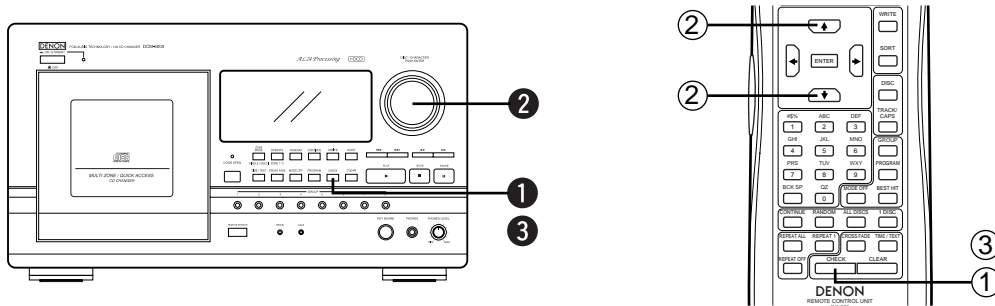

Checking the Best Hit List

Use this function to check the best hit list before or during playback.

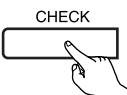

1   Press the CHECK button while in the best hit play mode.
 * There is no need to do this when in the stop mode.

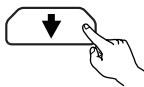

2    Turn the jog dial (or on the remote control unit use the ↑ or ↓ button) to move forward (backward) through the best hit list and check its contents.
 * "BEST LIST END" is displayed if the jog dial is turned clockwise (or on the remote control unit if the ↓ button is pressed) from the last step.

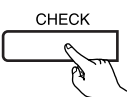
3   To stop checking the best hit list, press the CHECK button again.
 * There is no need to do this when in the stop mode.

Clearing CDs or Tracks from the Best Hit List

CDs or tracks in the best hit list can be cleared while stopped in the best hit play mode. (not possible in the Random mode)

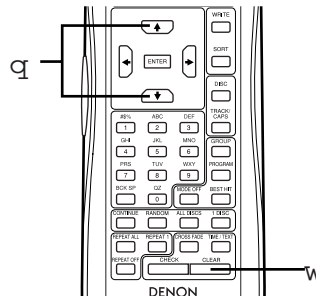
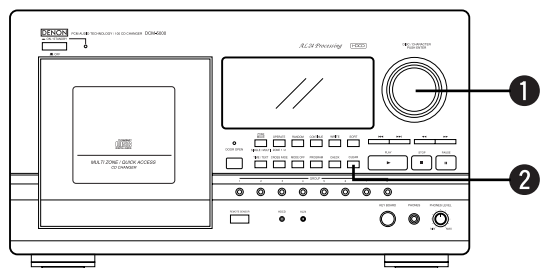

■ Clearing CDs (or tracks) in the middle of the best hit list

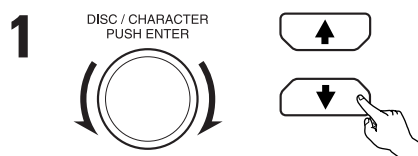

Turn the jog dial (on the remote control unit press the ↑ or ↓ button) to move forward (or backward) and display the step to be cleared.

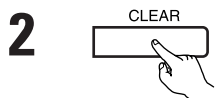

Press the CLEAR button.

- The CD (or track) for the displayed step number is cleared and the first step is displayed.



* If CLEAR is pressed without performing the operation in step 1, the first step is cleared.

- Clearing all steps in the best hit list: Hold down clear until "ALL CLEAR" is displayed. ("NO ENTRY" appears on the display)

■ Adding to the end of the best hit list

Follow steps 2 to 7 under "Registering Best Hits" (page 30) to add CDs (or tracks) to the end of the best hit list.

13 OSD (On-Screen Display)

Use this function to select CDs and register or edit programs and disc files while watching the monitor TV's screen.

■ On-screen display symbols

Symbol	Description
Ⓢ	Disc mark (Not displayed when there is no corresponding disc.)
⌘	Displayed when no discs are loaded in the disc rack.
ⓘ	Displayed when a disc is used in the sub zone.
▶	Displayed when a disc is playing.
⏸	Displayed when a disc is paused.
T	Displayed for CD-Text discs.
B	Displayed when the track is registered on the best hit list.
D	Displayed when the track is registered in the delete file.
✓	Displayed when the disc is registered in a group and indicates groups selected for group playback.
↑	When the ↑ button on the remote control unit is pressed, the cursor moves up.
↓	When the ↓ button on the remote control unit is pressed, the cursor moves down.
←	When the ← button on the remote control unit is pressed in the following cases: While at the disc number sort screen: The 10 previous discs are displayed. While at the disc title sort screen: The disc titles for the previous first letter (A ← B ← C) are displayed. While at the artists' name sort screen: The previous artists' names in alphabetical order are displayed. While at the character input screen: The character input position (cursor) moves to the left.
→	When the → button on the remote control unit is pressed in the following cases: While at the disc number sort screen: The 10 following discs are displayed. While at the disc title sort screen: The disc titles for the following first letter (A → B → C) are displayed. While at the artists' name sort screen: The following artists' names in alphabetical order are displayed. While at the character input screen: The character input position (cursor) moves to the right.

Basic Operation Screens

■ CD selection screens

Screen showing the discs sorted by disc number

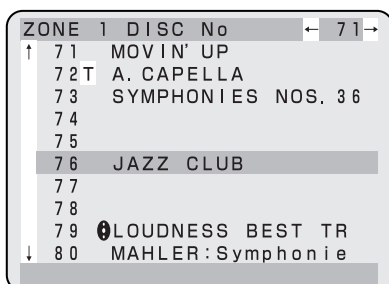

Screen showing the discs sorted by disc title

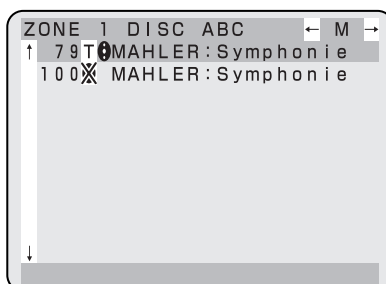

Screen showing the discs sorted by artist's name

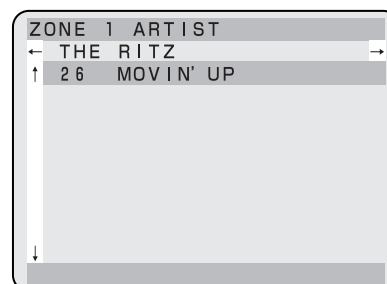

■ Screens in the play mode

In the single zone play mode

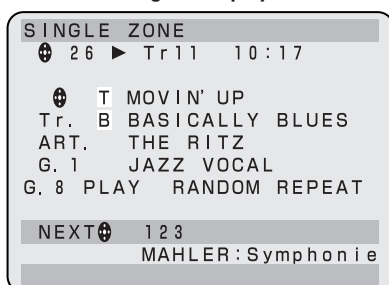

In the multi-zone play mode

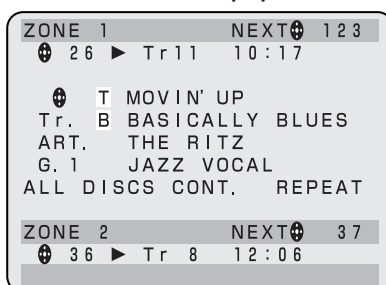

* During playback in the 1 DISC mode, use this screen to check the disc title, etc., and select the disc.

■ Screens when tracks are being selected and the delete file is being set

When tracks are selected

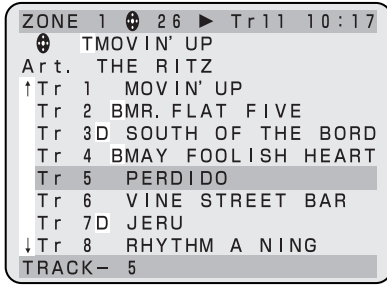

When the delete file is being set

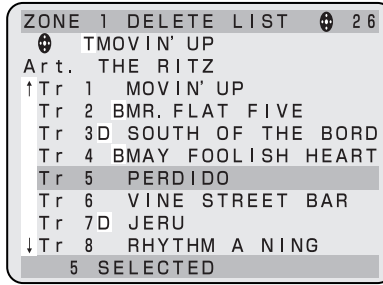

Program Operation Screens

1 Press the PROGRAM button.

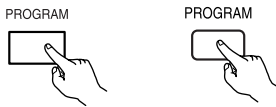

* On the remote control unit, press the PROGRAM button, then press a number button (1 to 4).

When the program has been set

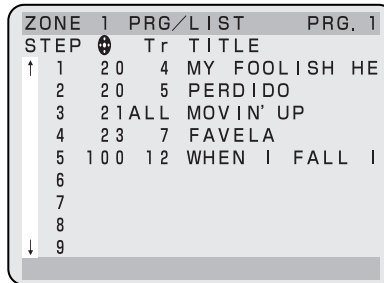

When the program has not been set

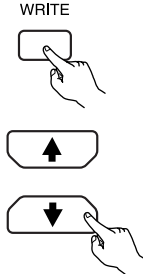
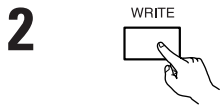
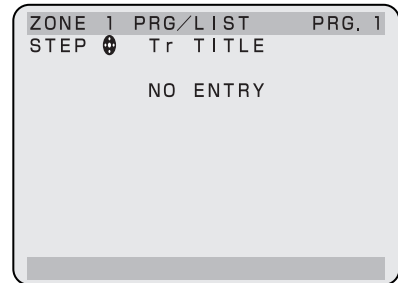

When the WRITE button is pressed, the screen switches to the disc selection screen.

Turn the jogdial (on the remote control unit press the ↑ or ↓ button) to move the cursor on the screen and select the desired disc.

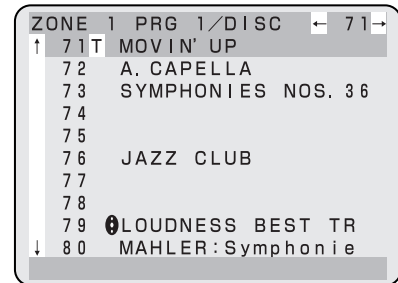

* To program all the tracks on the CD, proceed to step 4.

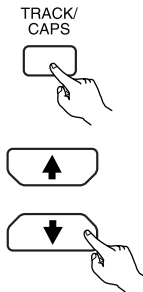
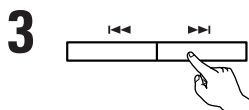

Press the **⏮** or **⏭** button (on the remote control unit press the TRACK/CAPS button) to switch to the track selection screen.

Turn the jogdial (on the remote control unit press the ↑ or ↓ button) to move the cursor on the screen and select the desired track.

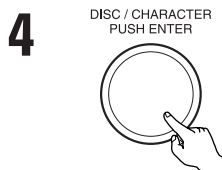
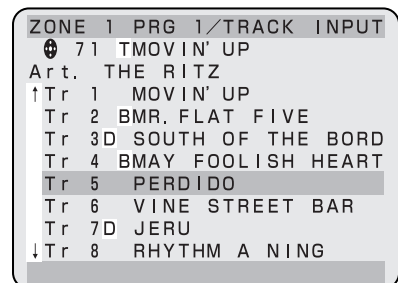

Press the ENTER button. The selected CD (or track) is set and the screen switches to the program list screen.

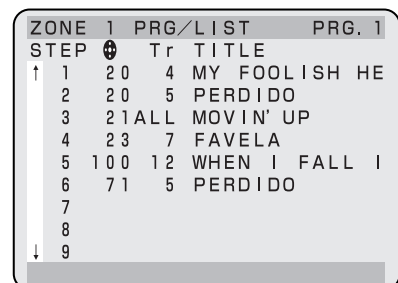

Disc File Operation Screen

1

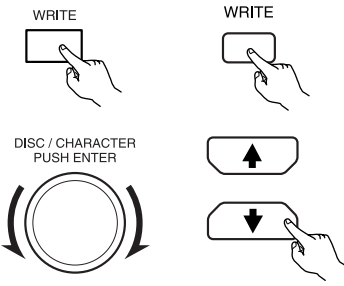

Press the WRITE button.
The disc file input screen appears.

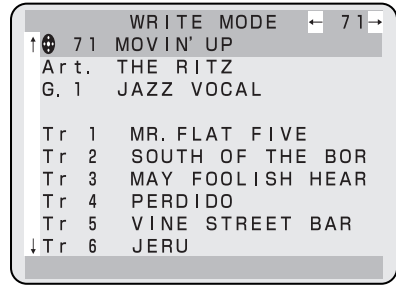

Turn the jog dial (on the remote control unit press the ↑ or ↓ button) to move the cursor and select the item to be edited.

2

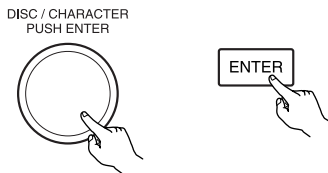

Press the ENTER button.
The screen switches to the input screen for the selected item.

* For instructions on inputting characters, refer to page 23.

When a disc or track title is selected

Disc title input screen

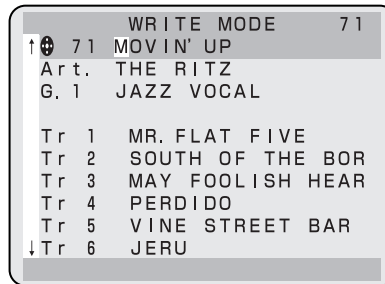

Track title input screen

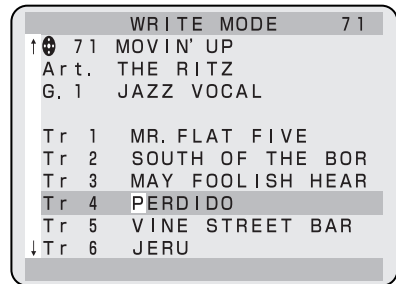

When an artist is selected

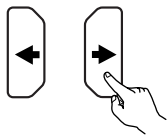

Use the ← and → buttons on the remote control unit to search for registered artists' names.

Press the ENTER button again to display the artist name input screen.

Display for selecting registered artists' names

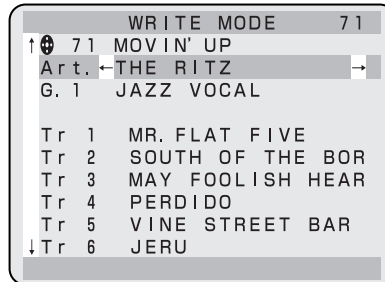

Artist name input screen

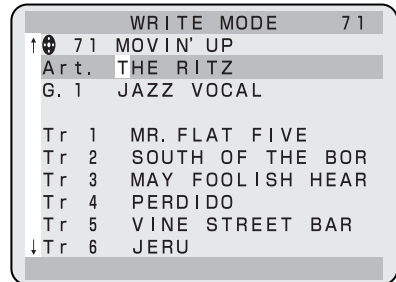

When a group is selected

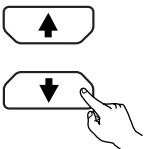

Use the ↑ and ↓ buttons on the remote control unit to search for registered groups.

Press the ENTER button again to register the group and display the group name input screen.

Display for selecting registered groups

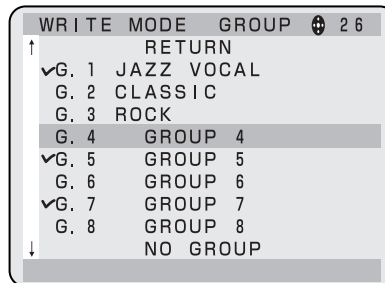

Group name input screen

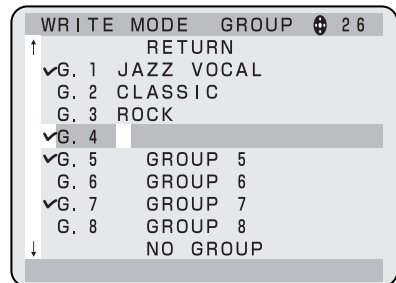

Other Operation Screens

Group selection screen

Press the GROUP button on the remote control unit to display group selection screen ①.



When a number button is pressed and a group is selected, group selection screen ② appears.

Group selection screen ①

ZONE 1 GROUP	
G. 1	CLASSIC
✓G. 2	ROCK
G. 3	JAZZ VOCAL
G. 4	POPS
G. 5	GROUP 5
G. 6	GROUP 6
G. 7	GROUP 7
G. 8	GROUP 8
GROUP—	

Group selection screen ②

ZONE 1 JAZZ VOCAL G. 3	
↑ 20	MOVIN' UP
26 ✕	A CAPELLA
29	SYMPHONIES NOS. 36
72 T	JAZZ CLUB
105	LOUDNESS BEST TR
106	
↓	

Best hit list checking screen

When CDs or tracks are registered on the best hit list

ZONE 1 BEST LIST			
STEP	Tr	TITLE	
↑ 1	20	4	MY FOOLISH HE
2	20	5	PERDIDO
3	21	ALL	MOVIN' UP
4	23	7	FAVELA
5	100	12	WHEN I FALL I
6			
7			
8			
↓ 9			

When no CDs or tracks are registered on the best hit list

ZONE 1 BEST LIST			
STEP	Tr	TITLE	
NO ENTRY			

Specify the step using the jog dial or the ↑ and ↓ buttons, then press ENTER (PLAY) to play the desired track (or CD).

14 CONNECTING AND OPERATING A KEYBOARD

An IBM PC compatible keyboard can be connected and disc files can be created from the keyboard.

Connectable keyboard: IBM US101 keyboard
(connector: 6-pin mini DIN PS/2 type)

Applicable cord: SCAN CODE SET 02

Connecting the Keyboard

DCM-5000

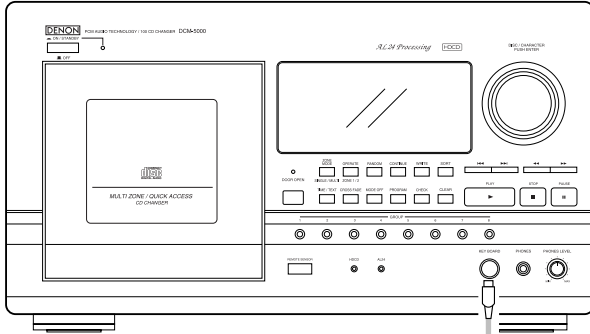

Keyboard

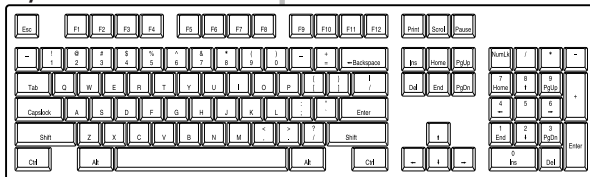

NOTE: Turn off the power of the DCM-5000 before connecting the keyboard.

Keyboard Operations

The keys on the keyboard are assigned to remote control unit and main unit operations.

- Operations before disc files are input

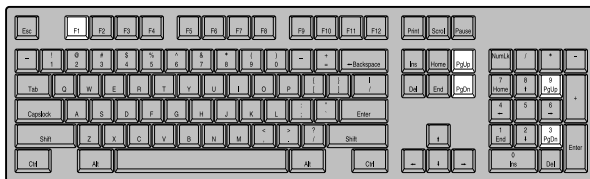

- F1** Sets the disc file input mode.
- PgUp** Decrements the disc number by 10.
- PgDn** Increments the disc number by 10.

- Operations after disc files are input

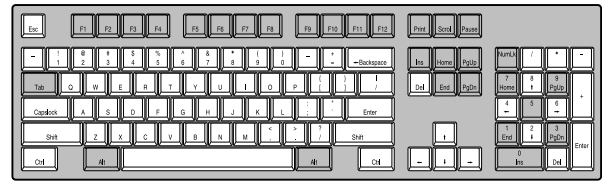

- Letter keys** Input small letters (when CapsLock is off).
- Number keys** Input numbers.
- Symbol keys** Input symbols.
- Backspace** Deletes previous character.
- Del** Deletes character.
- ←** Selects the line and item on the OSD.
- Selects the line and item on the OSD.
- ↑** Selects the line and item on the OSD.
- ↓** Selects the line and item on the OSD.
- Enter** Sets data, and selects the item.
- Esc** Cancels the disc file input mode.
- Shift + Capslock** Switches between small letters, and capital letters.

When keys are pressed while holding in the **Shift** key, the keys functions as follows:

- Letter keys** Input Capital letters (when CapsLock is off)
- Number keys** Input symbols.
- Symbol keys** Input (upper) symbols.

When keys are pressed while holding in the **Ctrl** key, the keys functions as follows:

- Del** Clears disc and track titles.

NOTES:

- Input numbers via keyboard: use top row keys 1, 2, 3 9, 0
- Num Lock keypad only provides cursor functions.



15 REMOTE CONTROL UNIT

The accessory RC-272 remote control unit can be used to control the CD player from a convenient distance.

Load batteries in the remote control unit before using it.

Inserting the dry cell batteries

1. Remove the battery cover on the back of remote control unit.

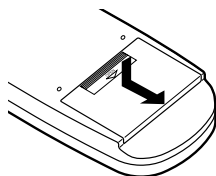

2. Insert two R6P (standard size AA) dry cell batteries with correct polarity as indicated inside the battery compartment.

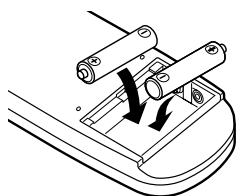

3. Replace the battery cover.

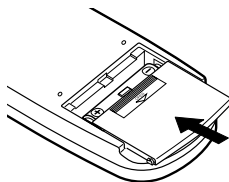

Notes on the Batteries

- The remote control unit uses standard size AA dry cell batteries.
- The batteries will need to be replaced approximately once a year. Replacement may be necessary earlier depending on how much the remote control unit is used.
- If, in less than a year from the time new batteries were inserted, the remote control fail to operate the CD player from a near-by position, it is time to replace the batteries.
- Insert the batteries properly, following the polarity diagram inside the battery compartment, in other words make sure (+) and (-) terminals are properly aligned.
- Batteries are prone to damage and leakage. Therefore:
 - Do not combine new batteries with used ones.
 - Do not combine different types of batteries.
 - Do not jumper opposite poles of the batteries, expose them to heat, break them open nor expose of them in open fire.
- If the remote control unit is not to be used for a long period of time, remove the batteries from the unit.
- If the batteries have leaked, remove any traces of battery fluid from the battery compartment, wiping thoroughly with a dry cloth. Then insert new batteries.

Directions for Use

- Operate the remote control unit while pointing it towards the remote control sensor on the CD player (see below).
- The remote control unit can be used at a distance up to 8 meters in a straight line from the CD player. This distance decreases if there are obstructions blocking the signal path or when the remote control unit is operated at an angle from the remote control sensor.
- The buttons on the remote control unit have identical functions with those on the CD player. However, the following functions cannot be remote controlled: Power ON/OFF.

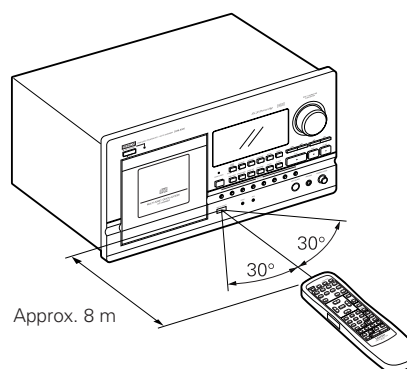

Notes on Operation

- Do not press identical buttons on the CD player and remote control unit simultaneously as this may cause malfunction.
- The remote control unit may be difficult to operate if the remote control sensor is exposed to strong light, such as direct sunlight or light from fluorescent lamp, or if these are obstacles between the remote control unit and the sensor.

Remote Control Unit RC-272

OPERATE ZONE 1/ZONE 2 buttons

Use these to select the play zone in the multi-zone mode.

DISC SKIP +/- buttons

Use these to skip the currently playing disc.

◀◀/▶▶ buttons

Use ▶▶ to return to previous tracks, ▶▶ to move ahead to subsequent tracks.

■ button

Stops playback.

⏸ button

Pauses playback.

▶ button

Starts playback.

◀◀ Manual search reverse

▶▶ Manual search forward

↑ / ↓ buttons

Use these to select items, etc., when checking programs, creating delete files and writing disc files.

← / → buttons

Use these to move the cursor in the writing mode, etc.

ENTER button

Press this button to set the character input mode, check the input characters, start playback, etc.

Number buttons

Use these to select CDs and tracks, to input characters, etc.

CONTINUE button

Press this button to select the continuous play mode.

RANDOM button

Press this button to select the random play mode.

ALL DISCS button

Press this button to select the all disc play mode.

1 DISC button

Press this button to select the one disc play mode.

REPEAT ALL button

Press this button to select the all-repeat play mode.

REPEAT 1 button

Press this button to select the one track repeat play mode.

REPEAT OFF button

Press this button to cancel the repeat mode.

POWER ON button

Press this when the main unit is in the standby mode to turn the power on.

STANDBY button

Press this when the main unit is in the power on mode to turn the power to the standby mode.

ZONE MODE SINGLE/MULTI button

Use this to select the zone mode.

WRITE button

Use this when registering programs, disc files and best hits.

SORT button

Use this to select the way in which the CDs are sorted.

DISC button

Use this to select CDs directly with the number buttons.

TRACK/CAPS button

Use this to select tracks directly with the number buttons and to select the characters type to be input.

GROUP button

Press this button to select the group.

PROGRAM button

Press this button to register and play programs.

BEST HIT button

Press this button to register and play best hits.

MODE OFF button

Press this button to cancel the group play, program play and best hit play modes.

CROSS FADE button

Press this button in the single zone play mode to turn the cross fade function on and off.

TIME/TEXT button

Switches the character display.

TIME: The CD number, track number and playing time are displayed.

TEXT: The text title, track title and artist's name are displayed.

CHECK button

Press this button to check the contents of the programs and delete file.

CLEAR button

Use this button to clear programs, disc file titles and the best hit list, and when creating delete files.

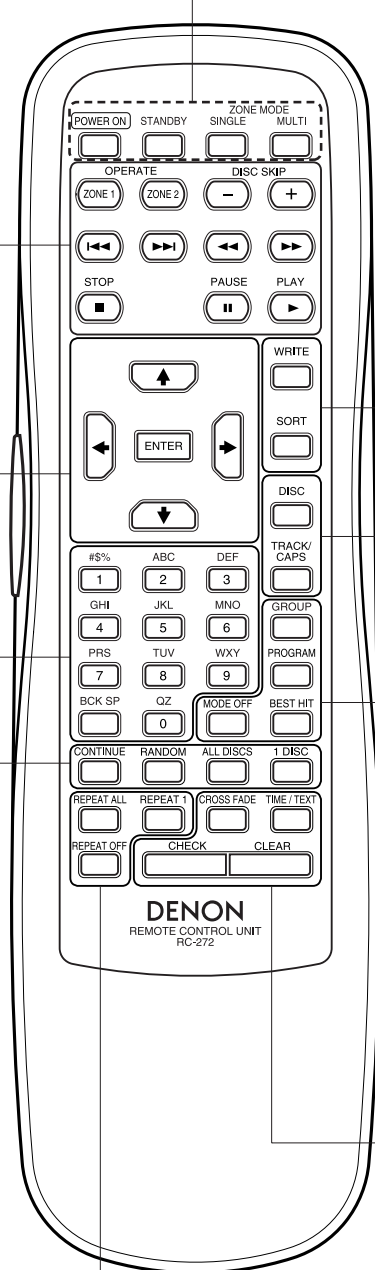

16 COMPACT DISCS

1. Cautions in Handling Compact discs

- Do not get fingerprints, oil, dirt or other substances on the compact disc. If the disc becomes dirty, wipe it off with a dry, soft cloth.
- Do not clean compact discs with benzene, paint thinner, water, record spray, anti-static agent, silicon cloth or similar substances.
- Take particular care to prevent scratches to the back side of the compact disc when removing it from the case and when inserting it in its case.
- Do not bend compact discs.
- Do not apply to compact discs.
- Do not attempt to enlarge the center hole of the disc.

- Do not write on the label (printed) side of the disc with a ball point pen or pencil.
- Bringing a CD into a warm room from a cold place could cause moisture to condense on the disc surface. Do not attempt to dry the disc with a hair dryer, etc.

2. Storage of Compact Discs

- To prevent dust, scratches, deformation, etc., be sure to store compact discs in their case.
- Do not store compact discs in the following locations.
 1. Places where direct sunlight strikes for long periods of time.
 2. Places with a high humidity or a lot of dust.
 3. Places reached by heat from a heater or similar appliance.

17 TROUBLESHOOTING

If a problem should arise, first check the following.

1. Are all connections correct ?

2. Have you operated the player according to the Operating Instructions ?

If this unit is not operating properly, check the items listed in the table below. Should the problem persist, there may be a malfunction. Disconnect the power immediately and contact your store of purchase.

Symptom	Cause	Measures	Page
Display not lit when power switch set to on.	<ul style="list-style-type: none"> • Power cord not plugged in securely. 	<ul style="list-style-type: none"> • Check the insertion of the power cord plug. • Turn the power on with the remote control unit after turning the POWER switch on. 	7 11
When the play button is pressed, playback does not start.	<ul style="list-style-type: none"> • There are no discs in the disc rack. • Is the disc dirty or scratched ? • Are you attempting to play the disc playing in the other zone or the next disc ? • Are you operating the other zone ? 	<ul style="list-style-type: none"> • Insert a CD. • Wipe the dirt off the disc or replace the disc. • Select a disc other than the disc playing in the other zone or the next disc. • Press the OPERATE button to specify the zone to be operated. 	9 40 11 11
There is no sound, or it is distorted.	<ul style="list-style-type: none"> • Is the output cord properly connected to the amplifier ? • Have the amplifier controls been set correctly ? 	<ul style="list-style-type: none"> • Check the connections. • Adjust the amplifier's controls. 	7 –
A specific position of the disc will not play.	<ul style="list-style-type: none"> • There are no discs in the disc rack. • Is the disc dirty or scratched ? 	<ul style="list-style-type: none"> • Insert a CD. • Wipe the dirt off the disc or replace the disc. 	9 40
Programmed playback does not work.	<ul style="list-style-type: none"> • Have programming been properly done ? 	<ul style="list-style-type: none"> • Reset the program. 	17
No data is output from the digital output lack.	<ul style="list-style-type: none"> • Is the pin cord properly connected ? 	<ul style="list-style-type: none"> • Check the connections. <p>NOTE: When the single zone mode is selected, no digital data is output from the zone 2 side.</p>	7
No buttons other than the OPEN button function.	<ul style="list-style-type: none"> • The dip switches on the rear panel are set to the external PC control mode. 	<ul style="list-style-type: none"> • Turn the power switch off, set the dip switches properly, then turn the power switch back on. 	8
This unit dose not operate properly when remote control unit is used.	<ul style="list-style-type: none"> • Batteries dead. • Remote control unit too far from this unit. • Obstacle between this unit and remote control unit. • Different button is begging pressed. • ⊕ and ⊖ ends of battery inserted in reverse. 	<ul style="list-style-type: none"> • Replace with new batteries. • Move closer. • Remove obstacle. <ul style="list-style-type: none"> • Press the proper button. • Insert batteries properly. 	38 38 38 – 38

18 ERROR MESSAGE

Error messages may appear on the panel's display window if a disc cannot be played or if the set stops operating. If this happens, follow the instructions on the table below.

<p>"Error 0*2* 000" to "Error 0*34 000" appears on the display. (* is a number code or alphabet A to F)</p>	<p>The disc is loaded upside-down in the disc rack or the disc is dirty or scratched. Check the disc again. If the problem persists, please inform your store of purchase of the displayed error code.</p>
<p>"Error 4827 ***" or "Error 4828 ***" appears on the display. (***) is a number code)</p>	<p>The disc rack may not be fully inserted in the set. Open the door and press the disc rack in again until it locks (until a click is heard). After closing the door, turn the power off, then turn the power back on to start up the set. If the problem persists, please inform your store of purchase of the displayed error code.</p>
<p>A code from "Error 4825 ***" to "Error 4842 ***" appears on the display. (except for the 4827 and 4828) (***) is a number code)</p>	<p>Please inform your store of purchase of the displayed error code.</p>

If the error code except for the table above appears, please inform your store of purchase of the displayed error code.

19 SPECIFICATIONS

ANALOG

ZONE 1/ZONE 2

No. of Channels:	2 Channels
Frequency Response:	2 ~ 20,000 Hz
Wow & Flutter:	Below measurable limit: (±0.001 % W.peak)
Output Level:	2.0 V

ZONE 1

Dynamic Range:	100 dB
Signal-to-noise Ratio:	110 dB
Harmonic Distortion:	0.005 % (1 kHz)

ZONE 2

Dynamic Range:	96 dB
Signal-to-noise Ratio:	100 dB
Harmonic Distortion:	0.008 % (1 kHz)

DIGITAL

Output:	COAXIAL (0.5 V _{P-P} 75 Ω/ohms) (ZONE 1/ZONE 2)
----------------	---

DISCS

Compact Disc format

GENERAL CHARACTERISTICS

Power Supply:	AC 120 V, 60 Hz (for North America model) AC 230 V, 50 Hz (for Europe model)
Power Consumption:	42 W
Dimensions:	434 (W) x 243 (H) x 474.5 (D) mm (17-3/32") x (9-9/16") x (18-43/64")
Weight:	16.2 kg (35 lbs 11 oz)

REMOTE CONTROL UNIT

Remote Control System:	RC-272 Infrared pulse system
Power Supply:	3 V DC; two R6P (standard size AA) dry cell batteries
External Dimensions:	68 (W) x 233 (H) x 20 (D) mm (2-43/64") x (9-11/16") x (25/32")
Weight:	Approx. 160 g (5.6 oz)

HDCD® and High Definition Compatible Digital® are registered trademarks of Pacific Microsonics, Inc.

* Design and specifications are subject to change without notice in the course of product improvement.

NIPPON COLUMBIA CO., LTD.

14-14, AKASAKA 4-CHOME, MINATO-KU, TOKYO 107-8011, JAPAN
Telephone: (03) 3584-8111
Cable: NIPPON COLUMBIA TOKYO Telex: JAPANOLA J22591

