

Frigidaire

Use & Care Manual

Frost-Free Chest Freezer

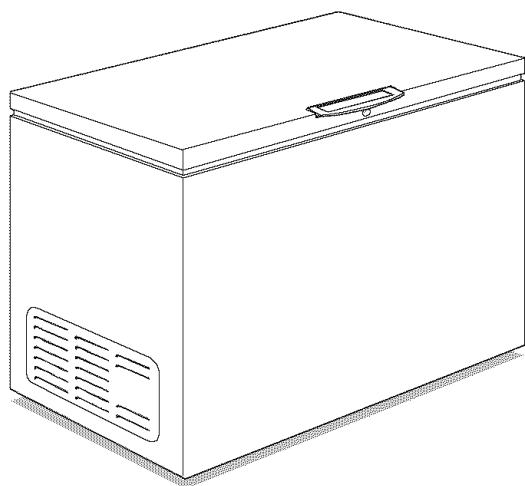

<u>Product Registration.....</u>	<u>2</u>
<u>Energy Saving Ideas.....</u>	<u>2</u>
<u>Important Safety Instructions.....</u>	<u>3</u>
<u>First Steps.....</u>	<u>4</u>
<u>Setting the Temperature Control.....</u>	<u>4</u>
<u>Freezer Optional Features.....</u>	<u>5</u>
<u>Care and Cleaning.....</u>	<u>5</u>
<u>Power Failure/Freezer Failure.....</u>	<u>6</u>
<u>Avoid Service Checklist.....</u>	<u>7 - 8</u>
<u>Warranty.....</u>	<u>9</u>

READ AND SAVE THESE INSTRUCTIONS

P/N 216993100 (June 2004)



Product Registration

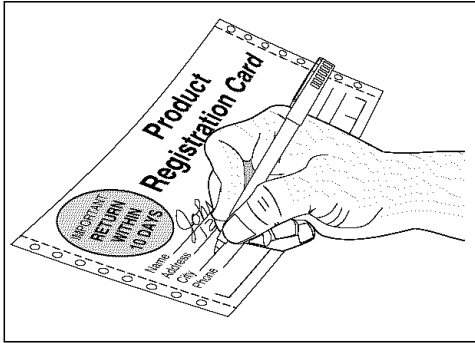

Versión en español

Si desea obtener una copia en español de este Manual del Usuario, sírvase escribir a la dirección que se incluye a continuación. Solicite la P/N 216997100.

Spanish Owner's Guides
Electrolux Home Products
P.O. Box 212378
Augusta, GA 30917

The information contained in this **Owner's Guide** will instruct you on how to properly operate and care for your product. Please read through the information contained in your literature pack to learn more about your new appliance.

Record Your Model and Serial Numbers

Record the Model No. and Serial No. of this freezer in the space provided below.

Model No. _____

Serial No. _____

Register Your Product

The self-addressed PRODUCT REGISTRATION CARD (shown left) should be filled in completely, signed and returned to Electrolux Home Products.

This Owner's Guide provides operating instructions for your model.
Use your freezer only as instructed in this Owner's Guide.

Energy Saving Ideas



- The freezer should be located in the coolest area of the room, away from heat producing appliances or heating ducts, and out of direct sunlight.
- Let hot foods cool to room temperature before placing in the freezer. Overloading the freezer forces the compressor to run longer. Foods that freeze too slowly may lose quality or spoil.
- Be sure to wrap foods properly and wipe containers dry before placing them in the freezer. This cuts down on frost build-up inside the freezer.
- Freezer baskets should not be lined with aluminum foil, wax paper, or paper toweling. Liners interfere with cold air circulation, making the freezer less efficient.
- Organize and label food to reduce lid openings and extended searches. Remove as many items as needed at one time, and close lid as soon as possible.

Important Safety Instructions

Proper Disposal of Your Refrigerator/Freezer

⚠ WARNING Risk of child entrapment. Child entrapment and suffocation are not problems of the past. Junked or abandoned refrigerators or freezer are still dangerous — even if they will sit for “just a few days.” If you are getting rid of your old refrigerator or freezer, please follow the instructions below to help prevent accidents.

BEFORE YOU THROW AWAY YOUR OLD REFRIGERATOR/FREEZER:

- Remove lid.

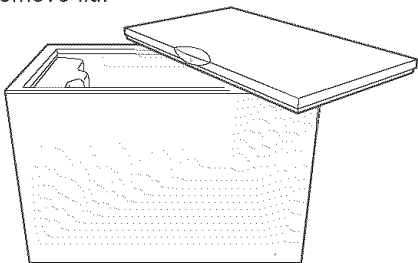

⚠ WARNING Avoid fire hazard or electric shock. Do not use an extension cord or an adapter plug. Do not remove any prong from power cord.

Grounding type wall receptacle

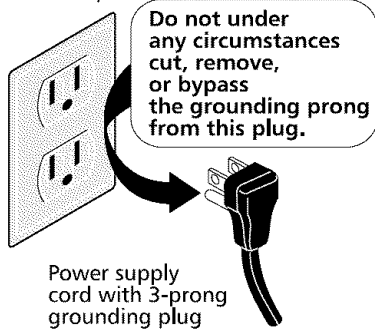

Read all instructions before using this freezer.

⚠ WARNING For Your Safety

Do not store or use gasoline or other flammable vapors and liquids in the vicinity of this or any other appliance. Read product labels for flammability and other warnings.

⚠ WARNING Child Safety

- Destroy carton, plastic bags, and any exterior wrapping material immediately after the freezer is unpacked. Children should never use these items for play. Cartons covered with rugs, bedspreads, plastic sheets or stretch wrap may become airtight chambers and can quickly cause suffocation.
- **A child might suffocate if he crawls into a freezer to hide or play. Remove the door of a freezer when not in use, even if you plan to discard the freezer.** Many communities have laws requiring you to take this safety precaution.
- Remove and discard any spacers used to secure the shelves during shipping. Small objects are a choke hazard to children.

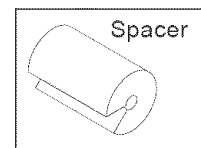

⚠ WARNING Electrical Information

These guidelines must be followed to ensure that safety mechanisms in the design of this freezer will operate properly.

- **Refer to the serial plate for correct electrical rating.** The power cord of the appliance is equipped with a three-prong grounding plug for protection against shock hazards. It must be plugged directly into its own properly grounded three-prong receptacle, protected with a 15 amp time delay fuse or circuit breaker. The receptacle must be installed in accordance with the local codes and ordinances. Consult a qualified electrician. Receptacles protected by Ground Fault Circuit Interrupters (GFCI) are NOT RECOMMENDED. **DO NOT use an extension cord or adapter plug.**
- If voltage varies by 10 percent or more, freezer performance may be affected. Operating the freezer with insufficient power can damage the motor. Such damage is not covered under the warranty. If you suspect your household voltage is high or low, consult your power company for testing.
- To prevent the freezer from being turned off accidentally, do not plug unit into an outlet controlled by a wall switch or pull cord.
- Do not pinch, knot, or bend power cord in any manner.

⚠ WARNING Other Precautions

- Never unplug the freezer by pulling on the power cord. Always grip the plug firmly and pull straight out from the receptacle.
- Turning the control to OFF turns off the compressor, but does not disconnect power to other electrical components.

First Steps

Before starting the freezer, follow these important first steps:

Installation

- Choose a place that is near a grounded electrical outlet.
- The freezer should be located where surrounding temperatures will not exceed 110°F (43°C). Temperatures of 32°F (0°C) and below will NOT affect freezer operation. Additional compressor heaters are not recommended.
- *Allow space around the unit for good air circulation. Leave a 3 inch (75 mm) space on all sides of the freezer for adequate circulation.*

Leveling

The freezer must have all bottom corners resting firmly on a solid floor. The floor must be strong enough to support a fully loaded freezer. **NOTE:** It is VERY IMPORTANT for your freezer to be level in order to function properly. If the freezer is not leveled during installation, the lid may be misaligned and not close or seal properly, causing cooling, frost, or moisture problems.

To Level Chest Unit:

If needed, add metal or wood shims between feet pads and floor.

Cleaning

- Wash any removable parts, the freezer interior, and exterior with mild detergent and warm water. Wipe dry. **DO NOT USE HARSH CLEANERS ON THESE SURFACES.**
- Do not use razor blades or other sharp instruments, which can scratch the appliance surface when removing adhesive labels. Any glue left from the tape can be removed with a mixture of warm water and mild detergent, or touch the residue with the sticky side of tape already removed. **DO NOT REMOVE THE SERIAL PLATE.**

LID REMOVAL

See Instructions on Hinge label. (UNPLUG THE UNIT.)

Setting the Temperature Control

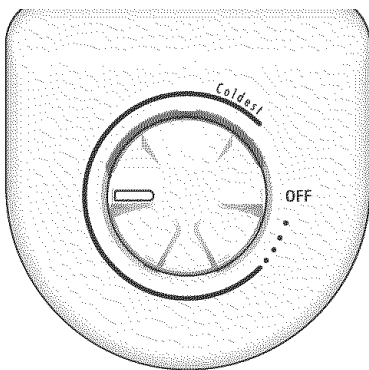

Cold Control

Cool Down Period

- For safe food storage, allow 4 hours for freezer to cool down completely. The freezer will run continuously for the first several hours. Foods that are already frozen may be placed in freezer after the first few hours of operation. Unfrozen foods should NOT be loaded into freezer until freezer has operated for 4 hours.
- When loading freezer, freeze only 3 pounds of fresh food per cubic foot of freezer space at one time. Distribute packages to be frozen evenly throughout the freezer. It is not necessary to turn control knob to a colder setting while freezing food.

Temperature Control

The temperature control is located inside the freezer. The temperature is factory preset to provide satisfactory food storage temperatures. However, the temperature control is adjustable to provide a range of temperatures for your personal satisfaction. If a colder temperature is desired, turn the temperature control knob toward COLDEST and allow several hours for temperatures to stabilize between adjustments.

Freezer Optional Features

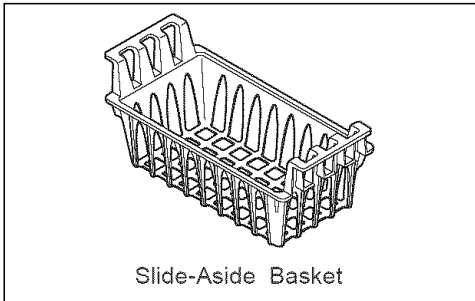

NOTE

Your freezer may have some, or all of the features listed below. Become familiar with these features, and their use and care.

Power On Light

The Power On Light indicates that the freezer is properly connected to electrical power. The light glows even when the temperature control is turned to OFF. If the light goes out, refer to "Freezer does not run" in the Avoid Service Checklist.

Security Lock with Pop-Out Key

This security lock fastens the door snugly, ensuring that stored food is secure. To lock or unlock the freezer, push the key into the lock and turn. The key pops out of the lock after it has been turned.

Interior Light

The light comes on automatically when the lid is opened. To replace the light bulb, turn the temperature control to OFF and unplug the electrical cord. Replace the old bulb with a bulb of the same wattage.

Slide-Aside Basket

This basket helps organize odd-shaped items. To reach other packages in the freezer, slide the basket aside or lift out.

Care and Cleaning

Damp objects stick to cold metal surfaces. Do not touch interior metal surfaces with wet or damp hands.

Your freezer is frost-free and defrosts automatically, but should be cleaned occasionally.

CAUTION

Freezer must be unplugged (to avoid electrical hazard) from power source when cleaning unit.

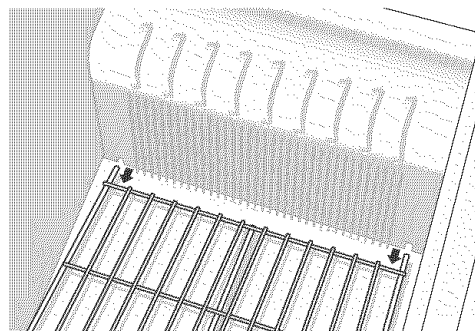
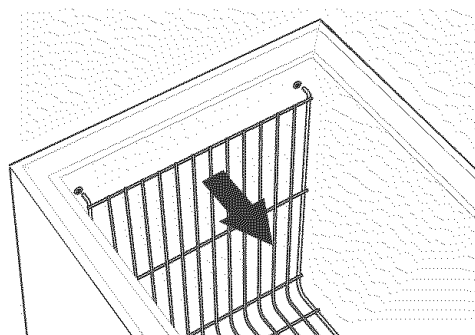

Cleaning the Inside

Wash inside surfaces of the freezer with a solution of two tablespoons of baking soda in one quart (1.136 litres) warm water. Rinse and dry. Wring excess water out of the sponge or cloth when cleaning in the area of the controls, or any electrical parts.

Wash the removable parts with the baking soda solution mentioned above, or mild detergent and warm water. Rinse and dry. **Never** use metallic scouring pads, brushes, abrasive cleaners, or alkaline solutions on any surface. Do not wash removable parts in a dishwasher.

CAUTION

Never attempt to operate freezer without this shelf correctly installed as it will not have adequate air circulation to function properly.

Wire Shelf Removal

Slide top prongs of wire shelf out of their locating holes in the top side of the cabinet. Lift and slide shelf at an angle to guide it out from the locating slots at the bottom of the cabinet and remove. Reverse this procedure to reinstall the shelf.

Cleaning the Outside

Wash the cabinet with warm water and mild liquid detergent. Rinse well and wipe dry with a clean soft cloth. Replace parts and food.

Power Failure/ Freezer Failure

WARNING

If leaving freezer lid open while on vacation, make certain that children cannot get into the freezer and become entrapped.

NOTE

Do not open freezer lid unnecessarily if freezer is off for several hours.

Vacation and Moving Tips

Short Vacations: Leave the freezer operating during vacations of less than three weeks.

Long Vacations: If the freezer will not be used for several months, remove all food and unplug the power cord. Clean and dry the interior thoroughly. To prevent odor and mold growth, leave the freezer lid open slightly, blocking it open if necessary.

Moving: Disconnect the power cord plug from the wall outlet. Remove foods and clean the freezer. Secure all loose items, such as baskets, by taping them securely in place to prevent damage. In the moving vehicle, secure freezer in an upright position, and secure to prevent movement. Also protect outside of freezer with a blanket, or similar item.

If a power failure occurs, frozen foods will stay frozen for at least 24 hours if the freezer is kept closed. If the power failure continues, pack seven or eight pounds of dry ice into the freezer every 24 hours. Look in the Yellow Pages under "Dry Ice," "Dairies," or "Ice Cream Manufacturers" for local dry ice suppliers. Always wear gloves and use caution when handling dry ice.

If the freezer has stopped operating, see "Freezer does not run" in the Avoid Service Checklist Section of this manual. If you cannot solve the problem, call an authorized servicer immediately.

If the freezer remains off for several hours, follow the directions above for the use of dry ice during a power failure. If necessary, take the food to a local locker plant until the freezer is ready to operate. Look in the Yellow Pages under "Frozen Food Locker Plants."

Avoid Service Checklist	Before calling for service, review this list. It may save you both time and expense. This list includes common occurrences that are not the result of defective workmanship or materials in this appliance.
OCCURRENCE	SOLUTION
Freezer does not run	<ul style="list-style-type: none"> • Check to ensure that freezer is not plugged into a circuit that has ground fault interrupt. If you are unsure about the outlet, have it checked by a certified technician. • Temperature control is in the OFF position. See <i>Setting the Temperature Control</i> section. • Freezer may not be plugged in or plug may be loose. Be sure plug is tightly pushed into electrical outlet. • House fuse has blown or circuit breaker has tripped. Check / reset circuit breaker or replace fuse with 15 amp time delay fuse. • Power outage. Check house lights. Call local electric company.
Freezer runs too much or too long	<ul style="list-style-type: none"> • Room or outside weather is too hot. It is normal for the freezer to work harder under these conditions. • Freezer has recently been disconnected for a period of time. Freezer requires 4 hours to cool down completely. • Large amounts of warm water or hot food have been stored recently. Warm food will cause the freezer to run more until the desired temperature is reached. • Lid is kept open too long or too frequently. Warm air enters the freezer every time the lid is opened. Open the lid less often. • Freezer lid may be slightly open. See OCCURRENCE “Lid Problems” • Temperature control is set too cold. Turn the control knob to a warmer setting. Allow several hours for the temperature to stabilize. • Freezer gasket is dirty, worn, cracked, or poorly fitted. Clean or change gasket. Leaks in the lid seal will cause freezer to run longer in order to maintain desired temperature.
Temperature inside freezer is too cold	<ul style="list-style-type: none"> • Temperature control is set too cold. Turn the control to a warmer setting. Allow several hours for the temperature to stabilize.
Temperature inside freezer is too warm	<ul style="list-style-type: none"> • Temperature control is set too warm. Turn the control to a colder setting. Allow several hours for the temperature to stabilize. • Lid is kept open too long or too frequently. Warm air enters the freezer every time the lid is opened. Open the lid less often. • Freezer lid may be slightly open. See OCCURRENCE “Lid Problems” • Large amounts of warm water or hot food have been stored recently. Wait until the freezer has had a chance to reach its selected temperature. • Freezer has recently been disconnected for a period of time. Freezer requires 4 hours to cool down completely.
Temperature of external freezer surface is warm	<ul style="list-style-type: none"> • The exterior freezer walls can be as much as 30°F warmer than room temperature. This is normal while the compressor works to transfer heat from inside the freezer cabinet.

OCCURRENCE	SOLUTION
Louder sound levels whenever freezer is ON	<ul style="list-style-type: none"> Modern freezers have increased storage capabilities and more even temperatures. They require a high efficiency compressor. When the surrounding noise level is low, you might hear the compressor running while it cools the interior.
Louder sound levels when compressor comes ON	<ul style="list-style-type: none"> Freezer operates at higher pressures during the start of the ON cycle. This is normal. Sound will level off or disappear as freezer continues to run.
Popping or cracking sound when compressor comes ON	<ul style="list-style-type: none"> Metal parts undergo expansion and contraction, as in hot water pipes. This is normal. Sound will level off or disappear as freezer continues to run.
Bubbling or gurgling sound, like water boiling	<ul style="list-style-type: none"> Refrigerant (used to cool freezer) is circulating throughout the system. This is normal.
Vibrating or rattling noise	<ul style="list-style-type: none"> Freezer is not level. It rocks on the floor when it is moved slightly. Level the unit. Refer to “Leveling” in the First Steps section. Floor is uneven or weak. Freezer rocks on the floor when it is moved slightly. Be sure floor can adequately support freezer. Level the freezer by putting wood or metal shims under part of the freezer. Freezer is touching the wall. Level the freezer or move freezer slightly. Refer to “Leveling” in the First Steps section.
Moisture forms on inside freezer walls	<ul style="list-style-type: none"> Weather is hot and humid, which increases internal rate of frost build-up. This is normal. Lid is slightly open. See OCCURRENCE “Lid Problems”. Lid is kept open too long, or is opened too frequently. Open the Lid less often.
Moisture forms on outside of freezer	<ul style="list-style-type: none"> Lid is slightly open, causing the cold air from inside the freezer to meet warm moist air from outside. See OCCURRENCE “Lid Problems”.
Odor in freezer	<ul style="list-style-type: none"> Interior needs to be cleaned. Clean interior with sponge, warm water and baking soda. Foods with strong odors are in the freezer. Cover the food tightly.
Lid Problems	<ul style="list-style-type: none"> Freezer is not level. It rocks on the floor when it is moved slightly. This condition can force the cabinet out of square and misalign the lid. Refer to “Leveling” in the First Steps section. Floor is uneven or weak. Freezer rocks on the floor when it is moved slightly. Be sure floor can adequately support freezer. Level the freezer by putting wood or metal shims under the freezer or brace the floor supporting the freezer.
Light bulb is not on	<ul style="list-style-type: none"> Light bulb is burned out. Follow directions under “Interior Light” in the “Freezer Features” section. No electric current is reaching the freezer. See OCCURRENCE “Freezer does not run”.

FREEZER WARRANTY

Your freezer is protected by this warranty

	WARRANTY PERIOD	THROUGH OUR AUTHORIZED SERVICERS, WE WILL:	THE CONSUMER WILL BE RESPONSIBLE FOR:
FULL ONE-YEAR WARRANTY	One year from original purchase date	Pay all costs for repairing or replacing any parts of this appliance which prove to be defective in materials or workmanship.	Costs of service calls that are listed under NORMAL RESPONSIBILITIES OF THE CONSUMER. *
LIMITED 2ND-5TH YEAR WARRANTY (Sealed System)	Second through fifth years from original purchase date	Repair or replace any parts in the Sealed Refrigeration System (compressor, condenser, evaporator, drier and tubing) which prove to be defective in materials or workmanship, and provide the labor to install such part.	Diagnostic costs and any removal, transportation and reinstallation costs, which are required because of service. Costs for labor, parts and transportation other than with respect to the Sealed Refrigeration System.
LIMITED 6TH-10TH YEAR WARRANTY (Compressor Only)	Sixth through tenth years from original purchase date	Provide a replacement for any compressor, which proves to be defective in materials or workmanship.	Diagnostic costs and any removal, transportation and reinstallation costs, which are required because of service. Costs for labor, parts and transportation other than the cost of the replacement compressor itself.
LIMITED WARRANTY (Applicable to the State of Alaska)	Time periods listed above.	All of the provisions of the full and limited warranties above and the exclusions listed below apply.	Costs of the technician's travel to the home and any costs for pick up and delivery of the appliance required because of service.
THREE-YEAR LIMITED FOOD SPOILAGE PLAN	During the first three years from original purchase date.	If food loss results because of defects in materials or workmanship during the time periods listed above, and applies to the limitations stated in the normal responsibilities of the consumer listed below, Electrolux will reimburse the consumer for the actual food spoilage loss in excess of \$5.00 per occurrence, but not to exceed a cumulative maximum payment of \$100.00, provided the food losses: A) Are reported and the food shown to any Electrolux authorized servicer within 24 hours of the discovery of the loss. B) Are not occasioned by either the manual disconnection of the electrical power within the premises of the owner or a general power failure. C) Occur even though the owner exercised reasonable care and diligence to save food per suggestions furnished with the appliance.	

In the U.S.A., your appliance is warranted by Electrolux Home Products, Inc. We authorize no person to change or add to any of our obligations under this warranty. Our obligations for service and parts under this warranty must be performed by us or an authorized Electrolux Home Products, Inc. servicer. In Canada, your appliance is warranted by Electrolux Canada Corp.

***NORMAL RESPONSIBILITIES OF THE CONSUMER**

This warranty applies only to products in ordinary household use, and the consumer is responsible for the items listed below:

1. Proper use of the appliance in accordance with instructions provided with the product.
2. Proper installation by an authorized servicer in accordance with instructions provided with the appliance and in accordance with all local plumbing, electrical and/or gas codes.
3. Proper connection to a grounded power supply of sufficient voltage, replacement of blown fuses, repair of loose connections or defects in house wiring.
4. Expenses for making the appliance accessible for servicing, such as removal of trim, cupboards, shelves, etc., which are not a part of the appliance when it was shipped from the factory.
5. Damages to finish after installation.
6. Replacement of light bulbs and/or fluorescent tubes (on models with these features).

EXCLUSIONS

This warranty does not cover the following:

1. CONSEQUENTIAL OR INCIDENTAL DAMAGES SUCH AS PROPERTY DAMAGE AND INCIDENTAL EXPENSES RESULTING FROM ANY BREACH OF THIS WRITTEN OR ANY IMPLIED WARRANTY.
NOTE: Some states do not allow the exclusion or limitation of incidental or consequential damages, so this limitation or exclusion may not apply to you.
2. Service calls which do not involve malfunction or defects in workmanship or material, or for appliances not in ordinary household use. The consumer shall pay for such service calls.
3. Damages caused by services performed by servicers other than Electrolux Home Products, Inc. or its authorized servicers; use of parts other than genuine Electrolux Home Products, Inc. parts; obtained from persons other than such servicers; or external causes such as abuse, misuse, inadequate power supply or acts of God.
4. Products with original serial numbers that have been removed or altered and cannot be readily determined.

IF YOU NEED SERVICE

Keep your bill of sale, delivery slip, or some other appropriate payment record. The date on the bill establishes the warranty period should service be required. If service is performed, it is in your best interest to obtain and keep all receipts. This written warranty gives you specific legal rights. You may also have other rights that vary from state to state. Service under this warranty must be obtained by contacting Electrolux Home Products, Inc.:

This warranty only applies in the 50 states of the U.S.A., Puerto Rico, and Canada. Product features or specifications as described or illustrated are subject to change without notice. All warranties are made by Electrolux Home Products, Inc. In Canada, your appliance is warranted by Electrolux Canada Corp.

01-U-FR-02 (Rev. 01/2002)

USA
800•944•9044
 Electrolux Home Products, Inc.
 P.O. Box 212378
 Augusta, GA 30917

Canada
866•213•9397
 Electrolux Canada Corp.
 6150 McLaughlin Road
 Mississauga, Ontario
 L5R 4C2



Notes