

## ELECTRIC BUILT-IN OVEN

Use & Care Guide

## HORNO DE PARED

Manual del Usuario

Models, Modelos

790.4906\*

\* = Color number,  
número de color



ENGLISH

ESPAÑOL

---

## Table of Contents

Wall Oven Warranty .....	2	Control Pad Features .....	8
Product Record .....	2	Setting the Clock .....	9
Serial Plate Location .....	2	Setting the Oven Controls .....	10-13
<b>IMPORTANT SAFETY INSTRUCTIONS</b> .....	<b>3-4</b>	Self-Cleaning .....	16-17
Protection Agreements .....	5	General Care & Cleaning .....	18-22
Wall Oven Features .....	6	Adjusting the Oven Temperature .....	21
Oven Vent and Racks .....	7	Before You Call .....	22-23
Air Circulation in the Oven .....	7	Sears Service .....	24
		Español .....	25

---

### Please carefully read and save these instructions

This Use & Care Manual contains general operating instructions for your appliance and feature information for several models. Your product **may not** have all the described features. The graphics shown are representative. The graphics on your appliance may not look exactly like those shown. Common sense and caution must be practiced when installing, operating and maintaining any appliance.

---

### Kenmore Elite Appliance Warranty

#### One Year Limited Warranty

When installed, operated and maintained according to all instructions supplied with the product, if this appliance fails due to a defect in material or workmanship within one year from the date of purchase, call **1-800-4-MY-HOME**® to arrange for free repair. If this appliance is used for other than private family purposes, this warranty applies for only 90 days from the date of purchase.

#### This warranty covers only defects in material and workmanship. Sears will NOT pay for:

1. Expendable items that can wear out from normal use, including but not limited to filters, belts, light bulbs, and bags.
2. A service technician to instruct the user in correct product installation, operation or maintenance.
3. A service technician to clean or maintain this product.
4. Damage to or failure of this product if it is not installed, operated or maintained according to all instructions supplied with the product.
5. Damage to or failure of this product resulting from accident, abuse, misuse or use for other than its intended purpose.
6. Damage to or failure of this product caused by the use of detergents, cleaners, chemicals or utensils other than those recommended in all instructions supplied with the product.
7. Damage to or failure of parts or systems resulting from unauthorized modifications made to this product.

#### FIVE-YEAR LIMITED WARRANTY

For the second through the fifth year from the date of purchase, when installed and operated according to the Installation Instructions and Use & Care Guide, **Sears will supply the following range parts free of charge** if they fail for the reasons listed below. Customer must pay labor cost of installation.

- Cooktop glass if it fails due to thermal shock.
- Cooktop elements if they are defective.

#### What Sears will not cover:

- Failure of the product if it is abused, misused, or used for other than the intended purpose.
- Damage to the cooktop glass caused by the use of cleaners or utensils other than the recommended cleaning cream and tools.
- Damage to the cooktop glass caused by hardened spills of sugary materials (including starches from vegetables or pastas) or melted plastic that are not cleaned according to the directions in the Use & Care Guide.
- Repairs to parts or systems resulting from unauthorized modifications made to the appliance.

#### Disclaimer of implied warranties; limitation of remedies

Customer's sole and exclusive remedy under this limited warranty shall be product repair as provided herein. Implied warranties, including warranties of merchantability or fitness for a particular purpose, are limited to one year or the shortest period allowed by law. Sears shall not be liable for incidental or consequential damages. Some states and provinces do not allow the exclusion or limitation of incidental or consequential damages, or limitations on the duration of implied warranties of merchantability or fitness, so these exclusions or limitation may not apply to you.

This warranty applies only while this appliance is used in the United States and Canada.

This warranty gives you specific legal rights, and you may also have other rights which vary from state to state.

Sears, Roebuck and Co., Dept. 817WA, Hoffman Estates, IL 60179

Sears Canada Inc., Toronto, Ontario, Canada M5B 2B8

# Important Safety Instructions

Read all instructions before using this appliance.

Save these instructions for future reference.

This manual contains important safety symbols and instructions. Please pay attention to these symbols and follow all instructions given.

**⚠ WARNING** This symbol will help alert you to situations that may cause serious bodily harm, death or property damage.

**⚠ CAUTION** This symbol will help alert you to situations that may cause bodily injury or property damage.

- **Remove all tape and packaging before using the appliance.** Destroy the carton and plastic bags after unpacking the appliance. Never allow children to play with packaging material.
- **Proper Installation. Be sure your appliance is properly installed and grounded by a qualified technician in accordance with National Electrical Code ANSI/NFPA No.70 (USA) or CSA C22.1, PART 1 (Canada)-latest edition and local code requirements.** Install only per installation instructions provided in the literature package for this appliance.

Sears Parts & Repair is the recommended repair service for this appliance. Know how to disconnect the electrical power to the appliance at the circuit breaker or fuse box in case of an emergency.

**⚠ CAUTION** Electronic controllers can be damaged by cold temperatures. When you use your appliance for the first time, or if it has not been used for a long period of time, make sure that it has been exposed to a temperature above 0°C/32°F for at least 3 hours before connecting it to the power supply.

- **User Servicing. Do not repair or replace any part of the appliance unless specifically recommended in the manuals.** All other servicing should be done only by a qualified technician to reduce the risk of personal injury and damage to the appliance.
- **Never modify or alter the construction of an appliance by removing panels, wire covers or any other part of the product.**
- **Remove the oven door from any unused appliance if it is to be stored or discarded.**

**⚠ WARNING** Stepping, leaning, sitting or pulling down on the door of this appliance can result in



**⚠ WARNING**

- All wall ovens can tip.
- Injury to persons could result.
- Install anti-tip bracket packed with wall oven.
- See Installation Instructions.



To reduce the risk of tipping, the wall oven must be secured by properly installed anti-tip bracket provided with the wall oven. Refer to the Installation Instructions for proper anti-tip bracket installation.

serious injuries and may also cause damage to the appliance. Do not allow children to climb or play around the appliance.

- **Storage on Appliance. Flammable materials should not be stored near surface units.** This includes paper, plastic and cloth items, such as cookbooks, plasticware and towels, as well as flammable liquids. Do not store explosives, such as aerosol cans, on or near the appliance. Flammable materials may explode and result in fire or property damage.

**⚠ WARNING** Do not use the oven for storage.

**⚠ CAUTION** Do not store items of interest to children in the cabinets above an appliance. Children climbing on the appliance to reach items could be seriously injured.

- **Do not leave children alone. Children should not be left alone or unattended in the area where an appliance is in use.** They should never be allowed to sit or stand on any part of the appliance.
- **DO NOT TOUCH SURFACE UNITS OR AREAS NEAR THESE SURFACES.** Surface units may be hot even though they are dark in color. Areas near surface units may become hot enough to cause burns. During and after use, do not touch, or let clothing or other flammable materials touch these areas until they have had sufficient time to cool. Among these areas are the cooktop and areas facing the cooktop.
- **Wear Proper Apparel. Loose-fitting or hanging garments should never be worn while using the appliance.** Do not let clothing or other flammable materials contact hot surfaces.

**⚠ WARNING** Never use your appliance for warming or heating the room.

- **Do Not Use Water or Flour on Grease Fires.** Smother the fire with a pan lid, or use baking soda, a dry chemical or foam-type extinguisher.
- **When heating fat or grease, watch it closely.** Fat or grease may catch fire if allowed to become too hot.
- **Use Only Dry Potholders. Moist or damp potholders on hot surfaces may result in burns from steam.** Do not let the potholders touch hot heating surface units. Do not use a towel or other bulky cloth instead of a potholder.
- **Do Not Heat Unopened Food Containers. Buildup of pressure may cause the container to burst and result in injury.**

# Important Safety Instructions

**IMPORTANT—Do not attempt to operate the appliance during a power failure.** If power fails, always turn off the appliance. If the appliance is not turned off and the power resumes, it will begin to operate again. Once the power resumes, reset the clock and oven function.

## IMPORTANT INSTRUCTIONS FOR USING YOUR OVEN

- **Use Care When Opening an Oven Door**—Stand to the side of the appliance when opening the door of a hot oven. Let hot air or steam escape before you remove or replace food in the oven.
- **Keep Oven Vent Ducts Unobstructed.** The wall oven is vented at the upper control panel or at the center trim depending of the model. Touching the surfaces in this area when the wall oven is operating may cause severe burns. Also, do not place plastic or heat-sensitive items near the oven vent. These items could melt or ignite.
- **Placement of Oven Racks.** Always place oven racks in desired location while oven is cool. Remove all utensils from the rack before removing rack. If rack must be moved while oven is hot, use extreme caution. Use pot holders and grasp the rack with both hands to reposition. Do not let pot holders contact the hot oven element or interior of the oven.
- **Do not use the broiler pan without its insert.** The broiler pan and grid allow dripping fat to drain and be kept away from the high heat of the broiler.
- **Do not cover the broiler grid or oven bottom with aluminum foil.** Exposed fat and grease could ignite.
- **Do not touch a hot oven light bulb with a damp cloth.** Doing so could cause the bulb to break. Disconnect the appliance or shut off the power to the appliance before removing and replacing the bulb.
- **Protective liners**—Do not use aluminum foil to line the oven bottom. Only use aluminum foil as recommended in this manual. Improper installation of these liners may result in risk of electric shock, or fire.

## IMPORTANT INSTRUCTIONS FOR CLEANING YOUR OVEN

- **Clean the appliance regularly to keep all parts free of grease that could catch fire.** Exhaust fan ventilation hoods and grease filters should be kept clean. Do not allow grease to accumulate. Greasy deposits in the fan could catch fire. Refer to the hood manufacturer's instructions for cleaning.
- **Cleaners/Aerosols**—Always follow the manufacturer's recommended directions for use. Be aware that excess residue from cleaners and aerosols may ignite causing damage and/or injury.

## SELF CLEANING OVEN MODELS

- **Clean in the self-cleaning cycle only the parts of the appliance listed in this Owner's Guide.** Before using the self-cleaning cycle of the appliance, remove the broiler pan and any utensils stored in the appliance.
- **Do not clean the oven door gasket.** The door gasket is essential for a good seal. Care should be taken not to rub, damage or move the gasket.
- **Do not use oven cleaners.** No oven cleaner or oven liner protective coating of any kind should be used in or around any part of the appliance

**CAUTION** The health of some birds is extremely sensitive to the fumes given off during the self-clean cycle of any wall oven. Move birds to another well ventilated room.

## IMPORTANT SAFETY NOTICE

The California Safe Drinking Water and Toxic Enforcement Act requires the Governor of California to publish a list of substances known to the state to cause cancer, birth defects or other productive harm, and requires businesses to warn customers of potential exposure to such substances.

## Product Record

In this space below, record the date of purchase, model and serial number of your product. You will find the model and serial number printed on the serial plate.

Model No. **790.** \_\_\_\_\_

Serial No. \_\_\_\_\_

Date of purchase \_\_\_\_\_

Save these instructions and your sales receipt for future reference.

## Serial Plate Location

You will find the model and serial number printed on the serial plate. The serial plate is located along the interior side trim of the lower oven and visible when the oven door is opened.

Remember to record the serial number for future reference.

Serial Plate Location

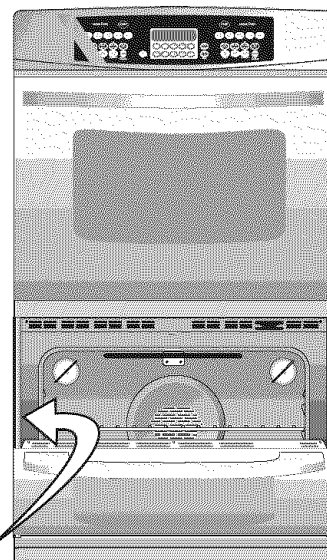

# PROTECTION AGREEMENTS

## In the U.S.A.

### Master Protection Agreements

Congratulations on making a smart purchase. Your new Kenmore® product is designed and manufactured for years of dependable operation. But like all products, it may require preventive maintenance or repair from time to time. That's when having a Master Protection Agreement can save you money and aggravation.

*Purchase a Master Protection Agreement now and protect yourself from unexpected hassle and expense.*

The Master Protection Agreement also helps extend the life of your new product. Here's what's included in the Agreement:

- ✓ **Expert service** by our 12,000 professional repair specialists
- ✓ **Unlimited service and no charge** for parts and labor on all covered repairs
- ✓ **"No-lemon" guarantee** – replacement of your covered product if four or more product failures occur within twelve months
- ✓ **Product replacement** if your covered product can't be fixed
- ✓ **Annual Preventive Maintenance Check** at your request – no extra charge
- ✓ **Fast help by phone** – phone support from a Sears technician on products requiring in-home repair, plus convenient repair scheduling
- ✓ **Power surge protection** against electrical damage due to power fluctuations
- ✓ **Rental reimbursement** if repair of your covered product takes longer than promised

Once you purchase the Agreement, a simple phone call is all that it takes for you to schedule service. You can call anytime day or night, or schedule a service appointment online.

Sears has over 12,000 professional repair specialists, who have access to over 4.5 million quality parts and accessories. That's the kind of professionalism you can count on to help prolong the life of your new purchase for years to come. Purchase your Master Protection Agreement today!

**Some limitations and exclusions apply.  
For prices and additional information call  
1-800-827-6655.**

### Sears Installation Service

For Sears professional installation of home appliances, garage door openers, water heaters, and other major home items, in the U.S.A. call **1-800-4-MY-HOME®**

## In Canada

### Maintenance Agreements

Your purchase has added value because you can depend on Sears HomeCentral® for service. With over 2400 Service Technicians and more than a million parts and accessories, we have the tools, parts, knowledge and skills to ensure our pledge: We Service What We Sell.

Your Kenmore® product is designed, manufactured and tested to provide years of dependable operation. But like all products, it may require service from time to time. The Sears Maintenance Agreement offers you an outstanding service program, affordably priced.

### The Sears Maintenance Agreement:

- Is your way to buy tomorrow's service at today's price
- Eliminates repair bills resulting from normal wear and tear
- Provides phone support from a Sears technician on products requiring in-home repair
- Even if you don't need repairs, provides an annual Preventive Maintenance Check, at your request, to ensure that your product is in proper running condition.

**Some limitations apply. For more information about Sears Canada Maintenance Agreements, call 1-800-361-6665**

ENGLISH

# Wall Oven Features

Note: The features of your wall oven will vary according to model.

## Your Electric Wall Oven Features At a Glance

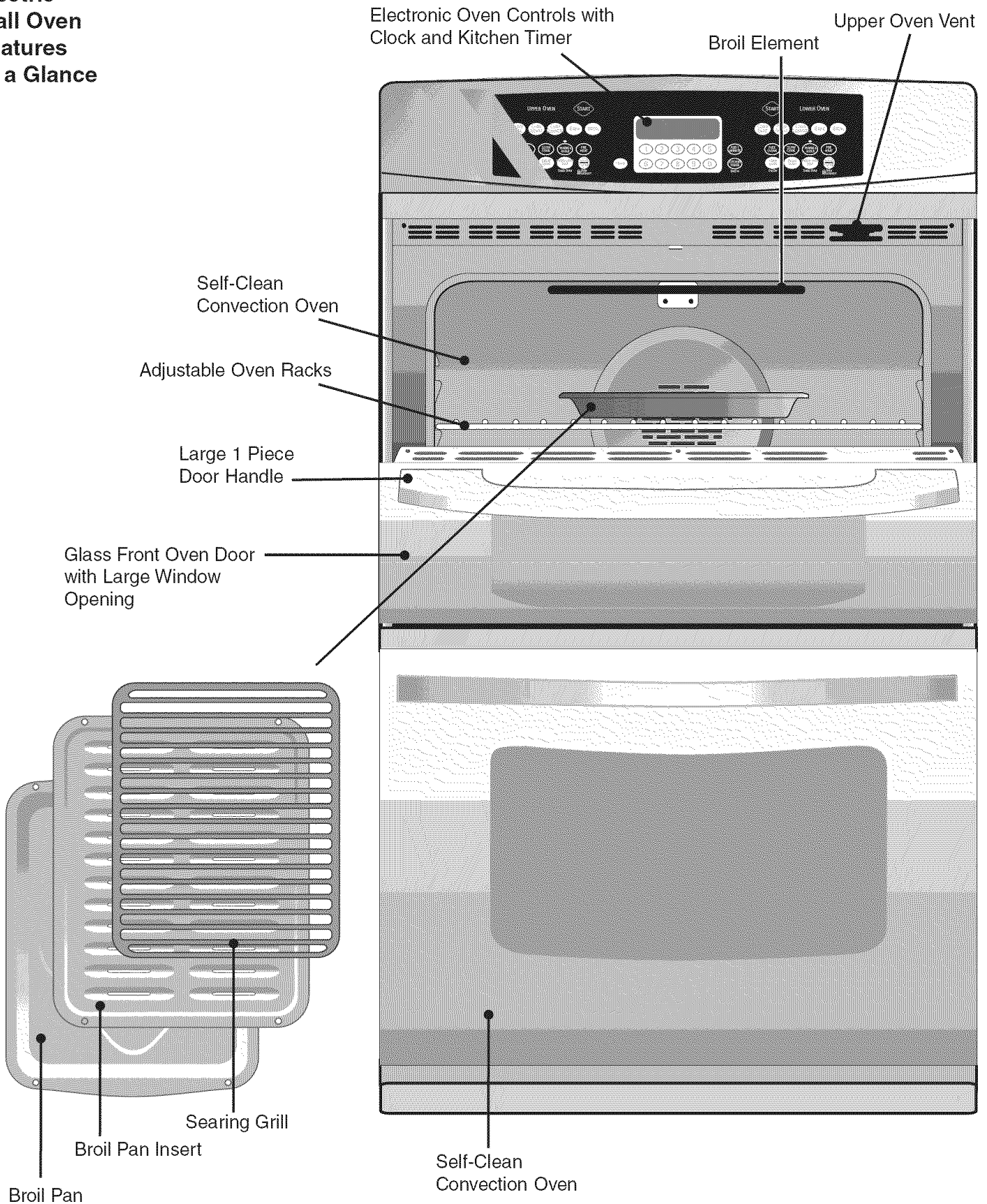

# Oven Vent and Racks

Upper Oven  
Vent Location

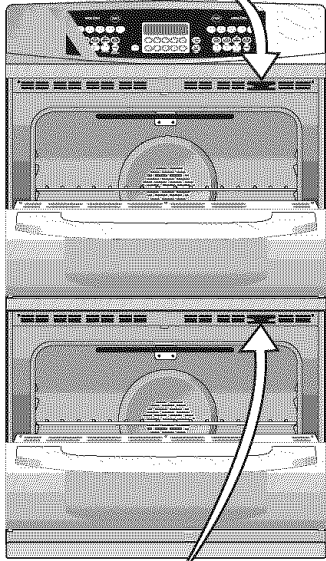

Lower Oven  
Vent Location

**CAUTION** Some models are equipped with a blower which runs in baking and self-cleaning mode to keep all internal components at a cool temperature. The blower may keep running even if the oven has been turned off, until the components have cooled down.

## Oven Vent Location

The oven is vented **at the center trim**. When the oven is on, warm air is released through the vent. This venting is necessary for proper air circulation in the oven and good baking results.

## Arranging Oven Racks

*ALWAYS ARRANGE OVEN RACKS WHEN THE OVEN IS COOL (PRIOR TO OPERATING THE OVEN).* Always use oven mitts when using the oven.

**To remove an oven rack**, pull the rack forward until it stops. Lift up front of rack and slide out.

**To replace an oven rack**, fit the rack onto the guides on the oven walls. Tilt the front of the rack upward and slide the rack back into place.

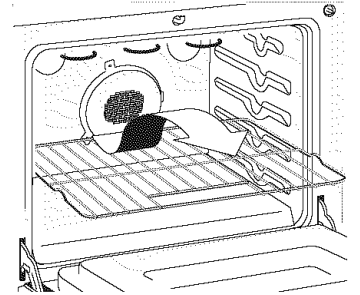

## Air Circulation in the Oven

If using 1 rack, place in center of oven. If using multiple racks, stagger cookware as shown.

For best air circulation and baking results allow 2-4" (5-10 cm) around the cookware for proper air circulation and be sure pans and cookware do not touch each other, the oven door, sides or back of the oven cavity. The hot air must circulate around the pans and cookware in the oven for even heat to reach around the food.

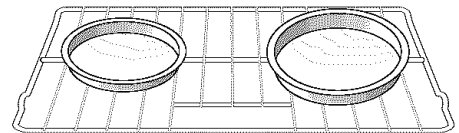

1 Oven Rack

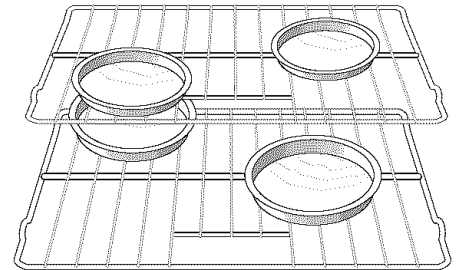

Multiple Oven Racks

ENGLISH

# Control Pad Features

**READ THE INSTRUCTIONS CAREFULLY BEFORE USING THE OVEN.** For satisfactory use of your oven, become familiar with the various features and functions of the oven as described below. **Detailed instructions for each feature and function follow later in this Use & Care Guide.**

**CONVECTION BAKE**— Use to select the Convection Bake feature.

**CONVECTION ROAST**— Use to select the convection roasting mode.

**CONVECTION CONVERT**— Use to select the Convection Convert feature.

**BAKEPAD**— Used to select the bake function.

**BROIL PAD**— Used to select the variable broil function.

**FLEX CLEAN PAD**— Used to select the Self-Cleaning cycle and Consumer Defined Control Features.

**START** — Use to start all oven features (not used with Oven Light).

**WARM & HOLD PAD**— Used to set the Warm & Hold feature.

**SLOW COOK**— Used for a slow cooking cycle.

**PREHEAT**— Use with normal bake pad.

**UPPER OVEN**

**LOWER OVEN**

**CONV BAKE** **CONV ROAST** **CONV CONVERT** **BAKE** **BROIL**

**FLEX CLEAN** **SLOW COOK** **WARM & HOLD** **PRE HEAT**

**OVEN LIGHT ON/OFF** **DELAY START** **OVEN COOK TIME** **STOP CLEAR** **CLOCK**

**OVEN LOCKOUT** **OVEN LOCKOUT**

**1** **2** **3** **4** **5**

**6** **7** **8** **9** **0**

**ADD 1 MINUTE** **KITCHEN TIMER ON/OFF**

**CONV BAKE** **CONV ROAST** **CONV CONVERT** **BAKE** **BROIL**

**FLEX CLEAN** **SLOW COOK** **WARM & HOLD** **PRE HEAT**

**OVEN LIGHT ON/OFF** **DELAY START** **OVEN COOK TIME** **STOP CLEAR**

**TIMED OVEN** **TIMED OVEN** **OVEN LOCKOUT**

**OVEN INTERIOR LIGHT PAD**— Used to turn oven interior light ON and OFF.

**OVEN COOK TIME PAD**— Used to enter the length of the baking time.

**CLOCK SET PAD**— Used to set the time of day.

**0 THRU 9 NUMBER PADS**— Use to enter temperature and times.

**ADD 1 MINUTE PAD**— Used to add 1 minute to the Timer Countdown. This feature works with the Kitchen Timer only and does not affect any cook time or start time functions (some models).

**KITCHEN TIMER ON/OFF PAD**— Used to set or cancel the minute timer. The minute timer does not start or stop cooking. Also, **TIMER SET/OFF Pad** is used to set the Continuous Bake Feature.

**DELAY START PAD**— Used to set the desired start time for baking. May be used with **COOK TIME** to program a delayed bake cycle.

**STOP CLEAR PAD**— Used to clear any function previously entered except the time of day and minute timer. Press **STOP CLEAR** to stop cooking. Also the **STOP CLEAR** pad is used to activate oven lockout setting.

## Minimum and Maximum Control Pad Settings

All of the features listed below have minimum and maximum time or temperature settings that may be entered into the control. An **ENTRY** acceptance beep will sound each time a control pad is touched (the **Oven Lockout** pad is delayed 3 seconds). An **ENTRY ERROR** tone (3 short beeps) will sound if the entry of the temperature or time is below the minimum or above the maximum settings for the feature.

FEATURE	MINIMUM TEMP. /TIME	MAXIMUM TEMP. /TIME
PREHEAT TEMP.	170°F/77°C	550°F/288°C
BAKE TEMP.	170°F/77°C	550°F/288°C
BROIL TEMP.	400°F/205°C	HI-550°F/288°C
KITCHEN TIMER 12 Hr.	0:01 Min.	11:50 Hr./Min.
24 Hr.	0:01 Min.	11:50 Hr./Min.
CLOCK TIME 12 Hr.	1:00 Hr./Min.	12:59 Hr./Min.
24 Hr.	0:00 Hr./Min.	23:59 Hr./Min.
OVEN COOK TIME 12 Hr.	0:01 Min.	11:50 Hr./Min.
24 Hr.	0:01 Min.	11:50Hr./Min.
CLEAN TIME	2 hours	4 hours
CONVECTION BAKE	300°F/149°C	550°F/288°C
CONVECTION ROAST	300°F/149°C	550°F/288°C

# Setting the Clock

## Setting the Clock

The **CLOCK** pad is used to set the clock. The clock may be set for 12 or 24 hour time of day operation. The clock has been preset at the factory for the 12 hour operation. When the range is first plugged in, or when the power supply to the range has been interrupted, the timer in the display will flash with "PF" (power failure, See Figure 1).

When **PF** appears in the display, press **STOP CLEAR**. A beep will sound and PF will disappear.



Figure 1

### INSTRUCTIONS

#### To set the clock (example below for 1:30)

1. Press **CLOCK**. "TIME" will appear in the display (Figure 2).
2. Press **1** **3** **0** pads to set the time of day to 1:30 (Figure 3). "TIME" will stay in the display. Press **START**. "TIME" will disappear and the clock will start (Figure 4).

### PRESS

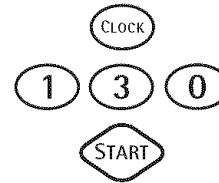

### DISPLAY



Figure 2



Figure 3



Figure 4

#### Changing between 12 or 24 hour time of day display

1. Press and hold **CLOCK** for 7 seconds (Figure 3). After 7 seconds, "12Hr" (Figure 5) or "24Hr" (Figure 6) will appear in the display and the control will beep once.
2. Press **FLEX CLEAN** to switch between the 12 and 24 hour time of day display. The display will show either "12Hr" (Figure 5) or "24Hr" (Figure 6).
3. Press **START** or **STOP CLEAR** and wait 5 seconds to accept the change.
4. Reset the correct time as described in **To set the Clock** above. Please note that if the 24 hour time of day mode was chosen, the clock will now display time from 0:00 through 23:59 hours.



Figure 5

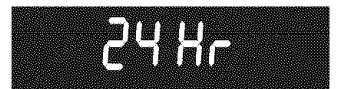



Figure 6

ENGLISH





# Setting the Clock

## Setting Continuous Bake or 12 Hour Energy Saving

The **KITCHEN TIMER**  and **FLEX CLEAN**  pads control the Continuous Bake or 12 Hour Energy Saving features. The oven control has a factory preset built-in 12 Hour Energy Saving feature that will shut off the oven if the oven control is left on for more than 11 hours and 59 minutes. The oven can be programmed to override this feature for Continuous Baking.

### INSTRUCTIONS

#### To set the control for Continuous Bake or 12 Hour Energy Saving features

1. Press and hold  for 7 seconds (Figure 1). After 7 seconds "Off 12Hr Off" will appear in the display (Figure 2).
2. Press  to switch between the 12 Hour Energy Saving and continuous bake features. Note: "On 12Hr On" (Figure 3) in the display indicates the control is set for the 12 Hour Energy Saving mode and "Off 12Hr Off" indicates the control is set for the Continuous Bake feature (Figure 2).
3. Press  or  and wait 5 seconds to accept the change. (Figure 4; display will return to time of day).

### PRESS

### DISPLAY

 for 7 seconds



Figure 1



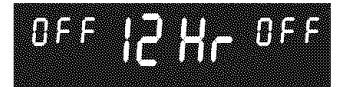

Figure 2





Figure 3

or 







Figure 4

## Setting Kitchen Timer

The **KITCHEN TIMER**  pad controls the Kitchen Timer feature. The Kitchen Timer serves as an extra timer in the kitchen that will beep when the set time has run out. It does not start or stop cooking. The Kitchen Timer feature can be used during any of the other oven control functions. Refer to "Minimum and Maximum Control Pad Settings" for time amount settings.

### INSTRUCTIONS

#### To set the Kitchen Timer (example: 5 minutes)

1. Press . "0:00" will appear and "TIMER" will flash in the display (Figure 5).
2. Press the number pads to set the desired time in the display (example ). Press . The time will begin to count down with "5:00" and "TIMER" will stay in the display (Figure 6). Note: If  is not pressed the timer will return to the time of day.
3. When the set time has run out, ":00" and "TIMER" will show in the display (Figure 7). The clock will beep until  is pressed.

### PRESS

### DISPLAY





Figure 5



Figure 6







Figure 7

#### To cancel the Kitchen Timer before the set time has run out

Press  twice until the clock displays ":0:00" and "TIMER". The display will return to the time of day.

## To Set Add 1 Minute Feature

The  ADD 1 MINUTE pad is used to set the Add 1 Minute feature. When the  pad is pressed, 1 minute is added to the Minute Timer feature if this feature is already active. If the Minute Timer feature is not active and the  pad is pressed, the Minute Timer feature will become active and will begin counting down from 1 minute. For further information on how to set the Minute Timer feature see To Set the Minute Timer instructions above.

# Consumer Defined Control

Note: The Consumer Defined Control features are adjustments to the control that will not affect cooking results. These include the Oven Lockout, Temperature Display and Silent Control Operation features

## Setting Oven Lockout Feature

The  pad controls the Oven Lockout feature. The Oven Lockout feature automatically locks the oven door and prevents the Oven from being turned on. It does not disable the clock, Kitchen Timer or the interior oven lights.

### INSTRUCTIONS

#### To activate the Oven Lockout feature

1. Press and hold  for 3 seconds (Figure 1).
2. After 3 seconds "Off" will appear in the display and a beep will sound. Once the oven door is locked "LOCK" will appear in the display (Figure 1).

#### To reactivate normal oven operation:

1. Press and hold  for 3 seconds. A beep will sound. "Off" will disappear from the display and "LOCK" will stay until the oven door has completely unlocked (Figure 2).
2. The wall oven is again fully operational (Figure 3).

### PRESS

 for 3  
seconds

 for 3  
seconds

### DISPLAY



Figure 1





Figure 2





Figure 3

## Setting Silent Control Operation

The **DELAY START**  and **FLEX CLEAN**  pads control the Silent Control operation feature. The Silent Control operation feature allows the oven control to be operated without sounds or beeps whenever necessary. If desired the control can be programmed for silent operation and later returned to operating with all the normal sounds and beeps.

### INSTRUCTIONS

#### To change control from normal sound operation to silent control operation

1. To tell if your range is set for normal or silent operation press and hold  for 7 seconds. "On bEEp On" will appear in the display (Figure 4).
2. Press  to switch between normal sound operation and silent operation mode. The display will show either "On bEEp On" (Figure 4) or "Off bEEp Off" (Figure 5).

If "On bEEp On" appears (Figure 4), the control will operate with normal sounds and beeps. If "Off bEEp Off" appears (Figure 5), the control is in the silent operation mode.

3. Press  or wait 5 seconds to accept the change.

### PRESS

 for 7 seconds





### DISPLAY



Figure 4

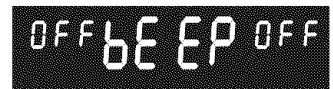



Figure 5





# Consumer Defined Control Features

## Setting Temperature Display — Fahrenheit or Celsius

The **BROIL**  and **FLEX CLEAN**  pads control the Fahrenheit or Celsius temperature display modes. The oven control can be programmed to display temperatures in Fahrenheit or Celsius. The oven has been preset at the factory to display in Fahrenheit.

### INSTRUCTIONS

#### To change display from Fahrenheit to Celsius or Celsius to Fahrenheit

1. To tell if the display is set for Fahrenheit or Celsius press  (figure 1) and hold for 7 seconds; Wait until "F" or "C" appears. If "F" appears, the display is set to show temperatures in Fahrenheit (Figure 2). If "C" appears, the display is set to show temperatures in Celsius (Figure 3).
2. Press  to switch between Fahrenheit or Celsius display modes. The display will show either "F" (Figure 2) or "C" (Figure 3).
3. Press  or  and wait 5 seconds to accept the change.

### PRESS

  
for 7seconds



 OR 

### DISPLAY



Figure 1



Figure 2



Figure 3





# Setting Oven Controls

## Setting Preheat

The **PREHEAT**  pad controls the Preheat feature. The Preheat feature will bring the oven up to temperature and then indicate when to place the food in the oven. Use this feature when recipes call for preheating. Preheating is not necessary when roasting or cooking casseroles. The oven can be programmed to preheat at any temperature between 170°F to 550°F.

### INSTRUCTIONS

#### To set the Preheat temperature for 350°F







1. Arrange the interior oven racks.
2. Press . "- - - °" and "BAKE" will appear in the display (Figure 1).
3. Press   . "350°" and "BAKE" will appear in the display (Figure 2).
4. Press . "PRE", "BAKE" and "ON" will appear in the display as the oven heats and reaches 350°F (Figure 3).

Note: After the oven has reached the desired temperature (this example, 350°F) the control will beep and the "PRE" light will turn off and oven temperature will be displayed (Figure 4). If you missed hearing the beep, you can tell that oven has reached preheat temperature if you see the oven temperature showing in the display. Once the oven has preheated, **PLACE FOOD IN THE OVEN**. The "BAKE" light will stay on.

Press  when baking is complete or to cancel the preheat feature.

#### To change Preheat temperature while oven is preheating (example: changing from 350 to 425°F)

If it is necessary to change the preheat temperature while the oven is preheating to the original temperature:

1. While preheating, press . "BAKE" will flash in the display (Figure 5)
2. Enter the new preheat temperature. Press   . "425°" and "BAKE" will appear in the display.
3. Press . "PRE" and "ON" will appear in the display as the oven heats to 425°F (Figure 6). A beep will sound once the oven temperature reaches 425°F and the display will show "425°" and "BAKE" (Figure 7).
4. When baking is complete press .

### PRESS

### DISPLAY



Figure 1

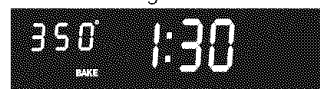

Figure 2



Figure 3

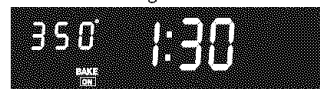

Figure 4



Figure 5



Figure 6





Figure 7







# Setting Oven Controls

## Setting Bake

The **BAKE**  pad controls normal baking. If preheating is necessary, refer to the **PRE HEAT**  Preheat Feature for instructions. The oven can be programmed to bake at any temperature from 170° F to 550° F (The sample shown below is for 350°F).





### INSTRUCTIONS

#### To set the Bake Temperature to 350°F

1. Arrange interior oven racks and place food in oven.
2. Press , "-- °" will appear and "BAKE" will flash in the display (Figure 1).
3. Press    (Figure 2). "BAKE" will continue to flash and "350°" will appear in the display.
4. Press . A beep will sound once the oven temperature reaches 350° F and the display will show "350°", "BAKE" and "ON" (Figure 3).

Pressing  will cancel the Bake feature at any time.

#### To change the Bake Temperature (example: changing from 350° to 425°F)

1. After the oven has already been set to bake at 350°F and the oven temperature needs to be changed to 425°F, press  (Figure 4) and "BAKE" will flash in the display.
2. Press    (Figure 5). "BAKE" will continue to flash "425°" and "ON" will appear in the display.
3. Press . "BAKE" and "425°" will stay in the display (See Figure 6).

Pressing  will cancel the Bake feature at any time.

### PRESS

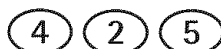

### DISPLAY



Figure 1



Figure 2



Figure 3



Figure 4



Figure 5



Figure 6

# Setting Oven Controls

## Oven Baking

For best cooking results, heat the oven before baking cookies, breads, cakes, pies or pastries, etc... There is no need to preheat the oven for roasting meat or baking casseroles.

The cooking times and temperatures needed to bake a product may vary slightly from your previously owned appliance.

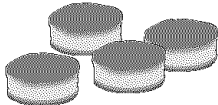
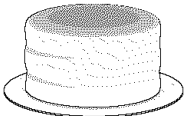
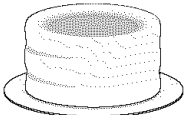
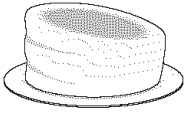
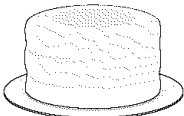
Baking Problems and Solutions Chart		
Baking Problems	Causes	Corrections
<p><b>Cookies and biscuits burn on the bottom.</b></p> 	<ul style="list-style-type: none"> <li>• Cookies and biscuits put into the oven before the preheating time is completed.</li> <li>• Oven rack overcrowded.</li> <li>• Dark pan absorbs heat too fast.</li> </ul>	<ul style="list-style-type: none"> <li>• Allow oven to preheat to the selected temperature before placing food in oven.</li> <li>• Choose pan sizes that will permit 5.1 cm to 10.2 cm (2" to 4") of air space on all sides when placed in the oven.</li> <li>• Use a medium-weight aluminum baking sheet.</li> </ul>
<p><b>Cakes too dark on top or bottom.</b></p> 	<ul style="list-style-type: none"> <li>• Cakes put into the oven before preheating time is completed.</li> <li>• Rack position too high or low.</li> <li>• Oven too hot.</li> </ul>	<ul style="list-style-type: none"> <li>• Allow oven to preheat to the selected temperature before placing food in the oven.</li> <li>• Use proper rack position for baking needs.</li> <li>• Set oven temperature 25°F/12°C lower than recommended.</li> </ul>
<p><b>Cakes not done in the center.</b></p> 	<ul style="list-style-type: none"> <li>• Oven too hot.</li> <li>• Incorrect pan size.</li> <li>• Pan not centered in oven.</li> </ul>	<ul style="list-style-type: none"> <li>• Set oven temperature 25°F/12°C lower than recommended.</li> <li>• Use pan size suggested in recipe.</li> <li>• Use proper rack position and place pan so there is 5.1 cm to 10.2 cm (2" to 4") of space on all sides of pan.</li> </ul>
<p><b>Cakes not level.</b></p> 	<ul style="list-style-type: none"> <li>• Range not level.</li> <li>• Pan too close to oven wall or rack overcrowded.</li> <li>• Pan warped.</li> </ul>	<ul style="list-style-type: none"> <li>• Place a marked glass measuring cup filled with water on the center of the oven rack. If the water level is uneven, refer to the installation instructions for leveling the range.</li> <li>• Be sure to allow 5.1 cm to 10.2 cm (2" to 4") of clearance on all sides of each pan in the oven.</li> <li>• Do not use pans that are dented or warped.</li> </ul>
<p><b>Foods not done when cooking time is up.</b></p> 	<ul style="list-style-type: none"> <li>• Oven too cool.</li> <li>• Oven overcrowded.</li> <li>• Oven door opened too frequently.</li> </ul>	<ul style="list-style-type: none"> <li>• Set oven temperature 25°F/12°C higher than suggested and bake for the recommended time.</li> <li>• Be sure to remove all pans from the oven except the ones to be used for baking.</li> <li>• Open oven door only after shortest recommended baking time.</li> </ul>

# Setting Oven Controls

## Setting Convection Bake

The **CONVECTION BAKE**  pad controls the Convection Bake feature.

Use the Convection Bake feature when cooking speed is desired. The oven can be programmed for Convection baking at any temperature between 300° F (149° C) to 550° F (288° C).

Convection baking uses a fan to circulate the oven's heat evenly and continuously within the oven (See Figure 1). This improved heat distribution allows for fast, even cooking and browning results. It also gives better baking results when using 2 or 3 racks at the same time. Breads and pastries brown more evenly. Convection bake cooks most foods faster and more evenly than conventional baking.

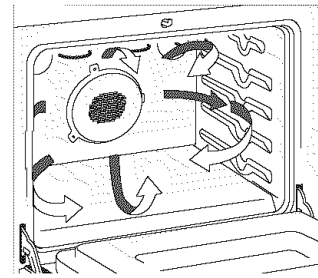

**Air circulation during Convection Bake**

Figure 1

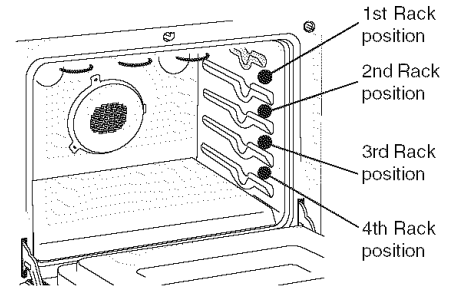

Figure 2

## General Convection Bake Instructions





1. When using Convection Bake, decrease your normal cooking times as shown on page 31. Adjust the cook time for desired doneness as needed. Time reductions will vary depending on the amount and type of food to be cooked. Cookies and biscuits should be baked on pans with no sides or very low sides to allow heated air to circulate around the food. Food baked on pans with a dark finish will cook faster.
2. Preheating is not necessary when cooking casseroles with Convection Bake.
3. When using Convection Bake with a single rack, place oven rack in position 2 or 3. If cooking on multiple racks, place the oven racks in positions 2 and 3.

### Benefits of Convection Bake:

- Some foods cook up to 30% faster, saving time and energy.
- Multiple rack baking.
- No special pans or bakeware needed.

## INSTRUCTIONS

### To set the oven for Convection Bake and temperature to 350°F

1. Arrange interior oven racks and place food in oven.
2. Press . "CONV BAKE" will flash and "- - -°" will appear in the display (Figure 3).
3. Press   . "CONV BAKE" and "350°" will appear in the display (Figure 4).
4. Press . "CONV BAKE", "PRE" and "ON" will appear in the display (Figure 5). The temperature will be decreased by 25°F (14°C). A beep will sound once the oven temperature reaches 325° F and the display will show "325°", "CONV BAKE" and "ON" (Figure 6).

Note: The convection fan will start AS SOON AS the oven is set for Convection Bake.

Press  to stop Convection Bake or cancel Convection Bake at any time.

**Note:** As soon as the  pad is pressed the set temperature will be decreased by 25°F (14°C).

## PRESS

## DISPLAY



Figure 3



Figure 4



Figure 5



Figure 6







# Setting Oven Controls

## Setting Convection Roast

This method of cooking enables you to obtain the best results when roasting. Allow your oven to preheat before roasting. A beep will let you know when the convection roast temperature is reached. The oven can be programmed to convection roast at any temperature from 300°F to 550°F (149°C to 288°C). Remember to use tested recipes with times adjusted for convection roasting when using the convection mode. Times may be reduced by as much as 30% when using the convection feature.

### INSTRUCTIONS

#### To Set the oven to Convection Roast at 350°F (176°C)

1. Arrange oven racks.
2. Press  "- - - °" will be displayed; "CONV" will flash (Figure 1).
3. Enter    using the number pads. "CONV" and "350°" will be displayed (Figure 2).
4. Press  "CONV", "PRE" and " will be displayed. A beep will sound once the oven temperature reaches 350° (Figure 3).

### PRESS

### DISPLAY

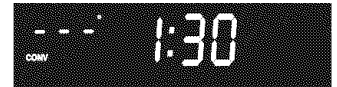

Figure 1



Figure 2









Figure 3





Figure 4

#### To change the preset Convection Roast Temperature (example: 425°F (218°C))

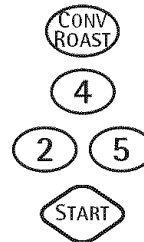
1. Press  "CONV" will flash.
2. Enter the desired roasting temperature using the number pads    (Figure 4).
3. Press  the current oven temperature, "CONV", "PRE" and " will be displayed.



After the oven has reached the desired temperature, "PRE" will disappear the control will beep and "CONV" light will stay on. The "" light will turn on and off as the oven maintains its temperature.

When convection roasting is complete press .



### INSTRUCTIONS

#### Setting Convection Convert

This function is used to convert a normal baking to a convection baking.

Be sure your oven is baking in a normal baking mode (Figure 5).

Press . "CONV" should now be displayed and the temperature decreased to convection baking temperature (Figure 6).

### PRESS

### DISPLAY



Figure 5



Figure 6



Figure 7

#### Note: For a timed convection convert.

After 75% of the cook time, the control will beep 3 times and "CF" (check food) will appear in the display (Figure 7)

The control will continue to beep 3 times every minute for the rest of the timed convection bake.

# Setting Oven Controls

## Setting the Slow Cook Feature

The  **SLOW COOK** pad is used to activate this feature. The Slow Cook feature may be used to cook foods more slowly, at lower oven temperatures and provides cooking results much the same way as a Slow Cooker or Crock-Pot. The Slow Cook feature is ideal for roasting beef, pork & poultry. Slow Cooking meats may result in the exterior of meats becoming dark but not burnt. This is normal.

There are 2 settings available, high (HI) or low (LO). The maximum cook time for the Slow Cook feature is 12 hours unless the oven control has been changed to the Continuous Bake mode or the Sabbath mode has been activated. This feature may be used with the additional settings of a **Timed Bake** Slow Cook (see **Timed Bake** beginning with step 6-8) or a **Delayed Start Bake** Slow Cook (see **Delayed Start Bake** steps 6-10).

Below is a list of preparation and cooking tips you should review for best possible results using Slow Cook:

- Completely thaw all frozen foods before cooking with the Slow Cook feature.
- When using a single rack, place in position 4 or 5.
- Position multiple racks to accommodate size of cooking utensils when cooking multiple food items.
- Do not open the oven door often or leave the door open when checking foods. If the oven heat escapes often, the Slow Cook time may need to be extended.
- Cover the foods to keep them moist or use a loose or vented type cover to allow foods to turn crisp or brown.
- Roasts may be left uncovered so browning can occur. Cook times will vary; depending on the weight, fat content, bone & the shape of the roast.
- Use the recipe's recommended food temperature and a food thermometer to determine when the food is done.
- Preheating the oven will not be necessary when using the Slow Cook feature.
- Add any cream or cheese sauces during the last hour of cooking.

### INSTRUCTIONS

### PRESS

### DISPLAY

#### To Program the Oven to begin baking with the Slow Cook feature:



1. Place the food in the oven.
2. Press . "-- °" will appear in the display (Figure 1). (if no keypad is touched within 5 seconds the request for Slow Cook will be cleared).
3. Press and release  again to set the Slow Cook to **HI** or **LO** (Figure 2 and 3).



Figure 1

The high setting (**HI**) will appear in the display, Figure 2) is best for slow cooking from 4 to 5 hours. The low setting (**Lo**) will appear in the display, Figure 3) is best for slow cooking from 8 to 9 hours. The oven indicator light will turn ON below the time display indicating the oven has turned ON with the settings you choose.



Figure 2



Figure 3



4. Press  "**SLO**" will appear in the display (Figure 4).
5. If desired, add any **Timed Bake** or **Delayed Start Bake** settings at this time.
6. To cancel the Slow Cook feature press  at anytime.







Figure 4



# Setting Oven Controls

## Setting Timed Bake, Timed Convection Bake or Timed Convection Roast









The **BAKE**  or **CONVECTION BAKE**  or **CONVECTION ROAST**  and **OVEN COOK TIME**  pads control the Timed Bake feature. The automatic timer of the Timed Bake feature will turn the oven OFF after cooking for the desired amount of time you selected.

### INSTRUCTIONS

### PRESS

### DISPLAY

#### To program the oven to begin baking immediately and to shut off automatically (example : Bake at 350°F for 30 minutes)

1. Be sure the clock is set for the correct time of day.
2. Arrange interior oven rack(s) and place the food in the oven.
3. Press , "- - - °" will appear and "BAKE" will flash in the display (Figure 1).
4. Press    (Figure 2). "BAKE" will continue to flash and "350°" will appear in the display.
5. Press . "PRE", "BAKE" and "350°" will appear in the display (See Figure 3).
6. Press . "OVEN 1" and "TIME" will flash; The current time will change to 0 hr :00 (Figure 4).
7. Enter the desired baking time by pressing   .  
Note: Baking time can be set for any amount of time between 1 minute to 11 hours and 50 minutes.
8. Press . "PRE", "TIMED", "BAKE" and "ON" should now be displayed. Once the Timed Bake feature has started, the current time remaining will be displayed (Figure 6).

Press  when baking has finished or at any time to cancel the Timed Bake feature.

#### When the timed bake finishes:

1. "End", and the time of day will show in display. The oven will shut off automatically (Figure 7).
2. The control will beep 3 times. And "End" will remain in the display until  is pressed.

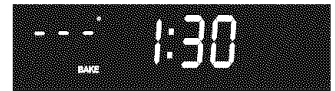

Figure 1



Figure 2



Figure 3



Figure 4



Figure 5



Figure 6



Figure 7

**NOTE:** Remember that the lowest **BAKE** temperature is **170°F** and that the lowest **CONVECTION BAKE** temperature is **300°F**.

**CAUTION** Use caution with the **TIMED BAKE** or **DELAYED TIME BAKE** features. Use the automatic timer when cooking cured or frozen meats and most fruits and vegetables. Foods that can easily spoil such as milk, eggs, fish, meat or poultry, should be chilled in the refrigerator first. Even when chilled, they should not stand in the oven for more than 1 hour before cooking begins, and should be removed promptly when cooking is completed. Eating spoiled food can result in sickness from food poisoning.



# Setting Oven Controls

## Setting Delayed Timed Bake or Delayed Timed Convection Bake

The **BAKE** (BAKE) or **CONVECTION BAKE** (CONV BAKE), **OVEN COOK TIME** (OVEN COOK TIME) and **DELAY START** (DELAY START) pads control the Delayed Time Bake feature. The automatic timer of the Delayed Time Bake will turn the oven **on and off** at the time you select in advance. **Note:** If your clock is set for normal 12 hour display mode the Delayed Timed Bake or Delayed Timed Convection Bake cycle can never be set to start more than 12 hours in advance. To set for Delayed Timed Bake or Delayed Timed Convection Bake 12-24 hours in advance set the control for the 24 hour time of day display mode.

### INSTRUCTIONS

### PRESS

### DISPLAY

To program the oven for a delayed **BAKE** start time and to shut off automatically (example: baking at 350°F, starting at 5:30 and baking for 30 minutes)

1. Be sure that the clock is set with the correct time of day.
2. Arrange interior oven rack(s) and place the food in the oven.
3. Press (BAKE). "--:--" will appear and "BAKE" will flash in the display (Figure 1).
4. Press (3) (5) (0) (Figure 2). "BAKE" will continue to flash and "350°" will appear in the display.
5. Press (START). "BAKE", "ON" and "350°" will stay in the display. (See Figure 3).
6. Press (OVEN COOK TIME). "OVEN 1" and "TIME" will flash, the current time will change to "0 hr : 00" and "350°" will remain in the display (Figure 4).
7. Enter the desired baking time using the number pads by pressing (3) (0). "OVEN 1 or 2" and "TIME" will flash; (Figure 5).  
Note: Baking time can be set for any amount of time from 1 minute to 11 hours and 50 minutes.
8. Press (START). "TIMED", "BAKE", "ON" and "350°" will remain in the display (Figure 6).
9. Press (DELAY START). "DELAY" will flash in the display. Enter the desired start time using the number pads (5) (3) (0) (Figure 7).
10. Press (START). When Delayed Time Bake starts, "DELAY" will disappear and the display clock will switch to the countdown of the oven cook time. The oven will start to bake at the previously selected temperature (Figure 9).

Press (STOP CLEAR) when baking has completed or at any time to cancel the Delayed Time Bake feature.

### When the set bake time runs out:

1. "End" will appear in the display and the oven will shut off automatically (Figure 10).
2. The control will beep 3 times. And "End" will remain in the display until (STOP CLEAR) is pressed.

(BAKE)



Figure 1

(3) (5) (0)



Figure 2

(START)



Figure 3

(OVEN COOK TIME)



Figure 4

(3) (0)

(START)



Figure 5

(DELAY START)



Figure 6

(5) (3) (0)

(START)



Figure 7

(STOP CLEAR)



Figure 8



Figure 9



Figure 10

# Setting Oven Controls

## Setting the Warm & Hold™ Feature

The **Warm & Hold**  pad turns ON the Warm & Hold feature and will maintain an oven temperature of 170°F (77°C). The Warm & Hold feature will keep oven baked foods warm for serving up to 3 hours after cooking has finished. After 3 hours the Warm & Hold feature will shut the oven OFF. The Warm & Hold feature may be used without any other cooking operations or can be used after cooking has finished using BAKE, CONVECTION BAKE .

The Warm & Hold feature may be used with TIMED BAKE if you wish to have the Warm & Hold feature turn ON automatically when cooking has finished. The Timed Bake features require you to set start time and the amount of cooking time. With this information the control can calculate the time when cooking will complete and can then start the Warm & Hold feature automatically.

### INSTRUCTIONS

### PRESS

### DISPLAY

#### To set Warm & Hold:



1. Arrange interior oven racks and place food in oven. If the food is already in the oven go to step 2.
  2. Press . "- - °" will appear in the display (Figure 1).  
Note: If no pad is touched within 5 seconds the request to turn ON Warm & Hold feature will be cancelled.
  3. Press . "HLd" and "ON" will appear in the display (Figure 2).
  4. To turn the Warm & Hold OFF at any time press .
- Note:** The Warm & Hold feature will automatically turn OFF after 3 hours.



Figure 1



Figure 2



ENGLISH

#### To set Warm & Hold to turn ON automatically:



1. Arrange interior oven racks and place food in oven. Set the oven properly for **Timed Bake**.
  2. Press . (Figure 3)  
Note: If no pad is touched within 5 seconds the request to turn ON Warm & Hold feature all functions previously programmed will be cleared.
  3. Press . The "HLd" will appear in the display after Timed Bake has finished (See Figure 4).
  4. To turn the Warm & Hold feature OFF at any time press .
- Note:** The Warm & Hold feature will automatically turn OFF after 3 hours.



Figure 3



Figure 4



Pressing  at any time will stop all oven baking operations.



# Setting Oven Controls

## Setting Broil

The **BROIL** pad controls the Broil feature. When broiling, heat radiates downward from the oven broiler for even coverage. The Broil feature is preset to start broiling at 550°F; however, the Broil feature temperature may be set between 400°F and 550°F. This range includes a Searing Grill for searing meats (Figure 6).

The broil pan and broil pan insert used together allow dripping grease to drain and be kept away from the high heat of the oven broiler. **DO NOT** use the broil pan without the insert (See Figure 5). **DO NOT cover the broil pan insert with foil.** The exposed grease could catch fire.

**⚠ WARNING** Should an oven fire occur, leave the oven door closed and turn off the oven. If the fire continues, throw baking soda on the fire or use a fire extinguisher. **DO NOT** put water or flour on the fire. Flour may be explosive and water can cause a grease fire to spread and cause personal injury.

### INSTRUCTIONS

#### To set the oven to broil at the default setting (550°F):

1. Place the broiler pan insert on the broiler pan. Then place the food on the broiler pan insert. **DO NOT** use the broiler pan without the insert. **DO NOT** cover the broiler insert with foil. The exposed grease could ignite.
2. Arrange the interior oven rack and place the broiler pan on the rack. Be sure to center the broiler pan directly under the broiler element. **Make sure the oven door is in the broil stop position (See Figure 4).**
3. Press **BROIL**. "BROIL" will flash and "-- °" will appear (Figure 1).
4. Press **5 5 0**. "BROIL" will continue to flash (Figure 2).
5. If a lower broil temperature is desired (minimum broil temperature setting is 400°F), press the desired temperature before continuing to step 6.
6. Press **START**. The oven will begin to broil. "BROIL", "550°" and **ON** will appear in the display (Figure 3).
7. Broil on one side until food is browned; turn and cook on the second side. Season and serve. **Note:** Always pull the rack out to the stop position before turning or removing food.
8. To cancel broiling or if finished broiling press **STOP CLEAR**.

### PRESS

### DISPLAY



Figure 1



Figure 2



Figure 3

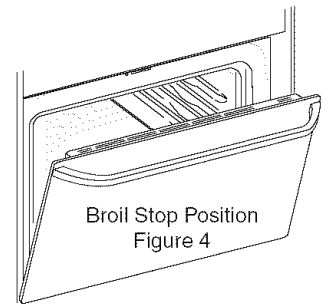

Broil Stop Position  
Figure 4

## Broiling Times and Searing Grill

Use the following table for approximate broiling times. Increase or decrease broiling times, or move the broiling pan to a different rack position to suit for doneness. If the food you are broiling is not listed in the table, follow the instructions provided in your cookbook and watch the item closely. Use the Searing Grill for meats and steaks if desired. Before placing the meat, be sure to heat the Searing Grill using Broil for 10 minutes. Cook times should be reduced 1-2 minutes per side when cooking with the Searing Grill. Place Searing Grill on top of Broiler Pan and insert for meats and steaks (See Figure 6).

### Electric Range Broiling Table Recommendations

Food Item	Rack Position	Temp Setting	Cook Time		Doneness
			1st side	2nd side	
Steak 1" thick	2nd	550° F	6:00	4:00	Rare
	2nd	550° F	7:00	5:00	Medium
Pork Chops 3/4" thick	2nd	550° F	8:00	6:00	Well
Chicken - Bone In	3rd	450° F	20:00	10:00	Well
Chicken - Boneless	2nd	450° F	8:00	6:00	Well
Fish	2nd	500° F	13:00	n/a	Well
Shrimp	3rd	550° F	5:00	n/a	Well
Hamburger 1" thick	2nd	550° F	9:00	7:00	Medium
	3rd	550° F	10:00	8:00	Well

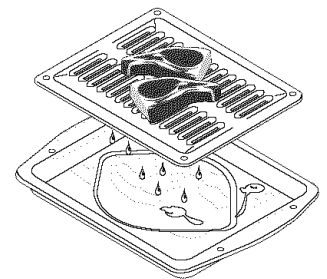
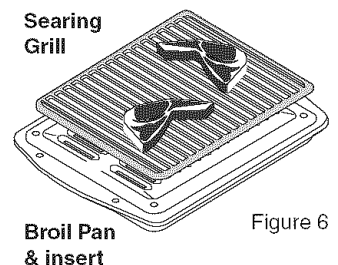

Figure 5





Searing Grill

Broil Pan & insert



Figure 6





# Setting Oven Controls

## To Set the Sabbath Feature (for use on the Jewish Sabbath & Holidays)

The  **COOK TIME** and  **DELAY START** pads are used to set the Sabbath feature. The Sabbath feature may only be used with the  **BAKE** pad. The oven temperature may be set higher or lower after setting the Sabbath feature (the oven temperature adjustment feature should be used only during Jewish Holidays), however the display will not visibly show or provide any audible tones indicating whether the change occurred correctly. Once the oven is properly set using Bake with the Sabbath feature active, the oven will remain continuously ON until cancelled. This will override the factory preset 12-Hour Energy Saving feature.





If the oven light will be needed during the Sabbath, press  before activating the Sabbath feature. Once the oven light is turned ON and the Sabbath feature is active, the oven light will remain ON until the Sabbath feature is turned OFF. If the oven light needs to be OFF, be sure to turn the oven light OFF before activating the Sabbath feature.

**IMPORTANT NOTES:** It is not advised to attempt to activate any other program feature other than **BAKE** while the Sabbath feature is active. ONLY the following key pads will function after setting the Sabbath feature;  to ,

, ,  & . **ALL OTHER KEYPADS** will not function once the Sabbath feature is properly activated.

### INSTRUCTIONS





#### To Program the Oven to Begin Baking Immediately & activate the Sabbath feature (example: baking at 350°F)

1. Be sure that the clock is set with the correct time of day.
2. Place the food in the oven.
3. Press . " --- °" appears in the display (Figure 1).
4. Within 5 seconds, press the , , . The display will show "350°F (177°C)." (Figure 2).
5. Press . The **ON** indicator light will be displayed (Figure 3).
6. If you desire to set the oven control for a **Timed Bake** or **Delayed Start Bake** do so at this time. If not, skip this step and continue to step 6. Refer to the **Timed Bake** (complete steps 6-8) / **Delayed Start Bake** (complete steps 6-10) section for complete instructions. Remember the oven will shut down after using **Timed Bake** or **Delay Start Bake** and therefore may only be used once during the Sabbath/Jewish Holidays. The maximum **Delayed Start Bake** time is 11 hours & 59 minutes.
7. The oven will turn ON and begin heating.

8. Press and hold both the  and  pads for at least 3

seconds. " --- " will appear in the display (Figure 4). Press  to switch between " --- " and **SAb** (Figure 5). (Sab indicates that the Sabbath mode is ON). SAb will appear in the display. Once SAb appears in the display the oven control will no longer beep or display any further changes and the **ON** indicator light will turn off. The oven is properly set for the Sabbath feature.

**Note:** You may change the oven temperature once baking has started by pressing , the numeric key pads for

the temperature you want (example for 425°C press , , ) and then pressing  (for Jewish Holidays only). Remember that **the oven control will no longer beep or display any further changes** once the oven is set for the Sabbath feature.

### PRESS

### DISPLAY



Figure 1



Figure 2



Figure 3



Figure 4



Figure 5

ENGLISH

# Setting Oven Controls

## To Set the Sabbath Feature (for use on the Jewish Sabbath & Holidays) (continued)

### INSTRUCTIONS

- The oven may be turned OFF at any time by first pressing  pad (this will turn the oven and the Sabbath feature OFF). **SAb** will disappear from the display.

### PRESS



### DISPLAY

Should you experience a power failure or interruption, the oven will shut off. When power is returned the oven will not turn back on automatically. The oven will remember that it is set for the Sabbath and the food may be safely removed from the oven while still in the Sabbath feature, however the oven cannot be turned back on until after the Sabbath.





After the Sabbath observance turn OFF the Sabbath feature by pressing  pad. **SAb** will disappear from the display and the oven may be used with all normal functions. For further assistance, guidelines for proper usage, and a complete list of models with the Sabbath feature, please visit the web at <http://www.star-k.org>.

## To Set the Recipe Recall Feature

This feature will ONLY recall a **Bake**, **Convection Bake**, **Convection roast**, **Slow Cook**, **Timed Bake** or a **Timed Bake** with a **Warm & Hold** added setting. This feature will not work with any other function including a **Delayed Timed Bake**, a **Clean Cycle** or a **Broil** setting.

### INSTRUCTIONS

#### To Program the Oven to Begin Baking Immediately and record a Recipe (example: Bake mode at 350°C)

- Place the food in the oven.
- Press . "--- °" appears in the display (Figure 1).
- Within 5 seconds, press , , . The display will show "350°F (177°C)" (Figure 2).
- Press and hold  pad for at least 3 seconds or until a beep sounds. The beep indicates that this recipe has been recorded for future recall.

### PRESS

### DISPLAY



Figure 1



Figure 2



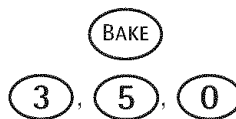

Figure 3



for 3 seconds

#### To Program the Oven to Begin Baking with a stored Recipe:

- Place the food in the oven.
- Press  followed by  (Figure 3).
- The oven will begin immediately to cook with the previously recorded recipe. The Temperature is recalled and if a Timed Bake was recorded this feature will also recall the cooking time.

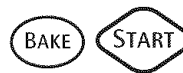

**Note:** When a recipe is recorded this is not possible to erase the recipe recall but you can overwrite it with another temperature for example here.

# Self-Cleaning

**CAUTION** During the self-cleaning cycle, the outside of the wall oven can become very hot to the touch. **DO NOT** leave a small children unattended near the appliance.

**CAUTION** The health of some birds is extremely sensitive to the fumes given off during the self-clean cycle of any wall oven. Move birds to another well ventilated room.

**CAUTION DO NOT** line the oven walls, racks, bottom or any other part of the appliance with aluminum foil. Doing so will destroy heat distribution, produce poor baking results and cause permanent damage to the interior (aluminum foil will melt to the interior surface of the oven).

**CAUTION DO NOT** force the oven door open. This can damage the automatic door locking system. Use caution when opening the door after the Self-Cleaning cycle is completed. The oven may still be VERY HOT.

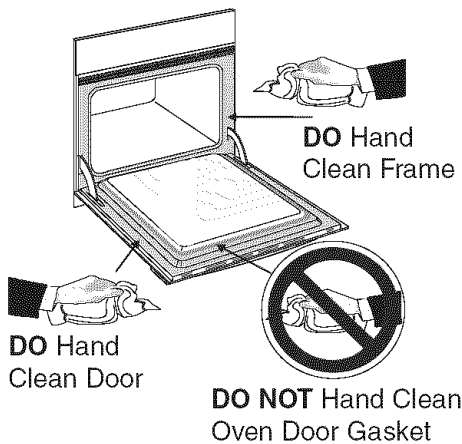

Note: See additional cleaning information for the oven door in the **General Care & Cleaning** section.



Figure 1

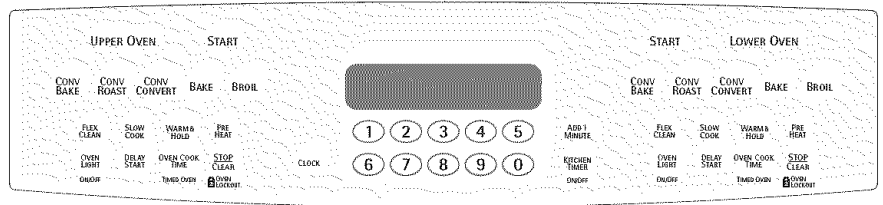

## Self-Cleaning Oven

A Self-Cleaning oven cleans itself with high temperatures (well above cooking temperatures) which eliminate soils completely or reduces them to a fine powdered ash you can wipe away with a damp cloth.

### Adhere to the following cleaning precautions:

- Allow the oven to cool before cleaning.
- Wear rubber gloves when cleaning any exterior parts of the oven manually.
- **DO NOT** clean the oven door gasket. The woven material of the oven door gasket is essential for a good seal. Care should be taken not to rub, damage or remove the gasket.
- **DO NOT** use any cleaning materials on the oven door gasket. Doing so could cause damage.
- **Remove the searing grill, broiler pan and broiler pan insert, all utensils and any aluminum foil. These items cannot withstand high cleaning temperatures.**
- This oven comes with lubricated porcelain oven racks, which can remain in the oven during the self-clean cycle. Do not clean this vegetable oil lubrication off the racks. It is important that the sides of the oven racks always have a light coating of vegetable oil. To maintain optimal rack performance, re-apply a thin layer of vegetable oil to the sides of the rack after every self-clean cycle or when the rack becomes difficult to slide.
- **Remove any excessive spillovers** in the oven cavity **before** starting the Self-Cleaning cycle. To clean, use hot, soapy water and a cloth. Large spillovers can cause heavy smoke or fire when subjected to high temperatures. **DO NOT** allow food spills with a high sugar or acid content (such as milk, tomatoes, sauerkraut, fruit juices or pie filling) to remain on the surface as they may leave a dull spot even after cleaning.
- Clean any soil from the oven frame, the door liner outside the oven door gasket and the small area at the front center of the oven bottom. These areas heat sufficiently to burn soil on. Clean with soap and water.

NOTE: Prior to setting the Self-Clean cycle, any spills remaining on the oven bottom should be removed.

If any time when setting the oven for the Self-Cleaning feature, the oven control continuously beeps and the display shows "dr"; close the oven door (see figure 1)

**CAUTION** The oven bake and broil elements may appear to have cooled after they have been turned OFF. **The elements may still be hot** and burns may occur if these elements are touched before they have cooled sufficiently.

# Self-Cleaning

## What to Expect during Cleaning

While the oven is in operation, the oven heats to temperatures much higher than those used in normal cooking. Sounds of metal expansion and contraction are normal. Odor is also normal as the food soil is being removed. Smoke may appear through the oven vent.

If heavy spillovers are not wiped up before cleaning, they may flame and cause more smoke and odor than usual. This is normal and safe and should not cause alarm. If available, use an exhaust fan during the self-cleaning cycle.









## To Start the Self-Clean Cycle

The **FLEX CLEAN**  pad controls the Self-Cleaning feature. If you are planning to use the oven directly after a self-clean cycle remember to allow time for the oven to cool down and the oven door to unlock. This normally takes about one hour. So a 3 hour self-clean cycle will actually take about 4 hours to complete.

\*It is recommend to use a 2 hour self-clean cycle for **light soils**, a 3 hour cycle for **average soils**, and a 4 hour cycle for **heavy soils** (to assure satisfactory results).

### INSTRUCTIONS

#### To set the controls for a 3 hour Self-Cleaning cycle to start immediately and shut off automatically

1. Be sure the clock is set with the correct time of day and the oven door is closed.
2. Press . "CLEAN", "1" and "TIME" will flash in the display (Figure 1). The control will automatically clean for a 3 hour period (default self-cleaning cycle time). Note: If a 2 or 4 hour clean time is desired, press    for 2 hour or press    for a 4 hour clean time. Set the cleaning time based on the amount of soil: light, medium or heavy (\* See above).
3. Press . The "OVEN" once the door has locked, "CLEAN", "LOCK" and "ON" will appear in the display (Figure 3).
4. When flex clean finishes, lock will remain in the display until the door has unlocked and "END" will appear (Figure 4)

Note: Allow about 15 seconds for the oven door lock to close.

#### When the Self-Clean Cycle is Completed

1. The time of day and "END" will remain in the display (Figure 4).
2. Once the oven has cooled down for approximately 1 HOUR, and "END" is no longer displayed, the oven door can then be opened (Figure 5).

#### Stopping or Interrupting a Self-Cleaning Cycle

If it becomes necessary to stop or interrupt a self-cleaning cycle due to excessive smoke or fire in the oven:

1. Press .
2. The oven door can only be opened after the oven has cooled down for approximately 1 HOUR, and "END" is no longer displayed (Figure 5).

**NOTE:** A smoke eliminator in the oven vent converts most of the soil into a colorless vapor.

**CAUTION** To avoid possible burns use care when opening the oven door after the Self-Cleaning cycle. Stand to the side of the oven when opening the door to allow hot air or steam to escape.

**CAUTION** DO NOT force the oven door open. This can damage the automatic door locking system. Use caution and avoid possible burns when opening the door after the Self-Cleaning cycle has completed. The oven may still be VERY HOT.

### PRESS

### DISPLAY

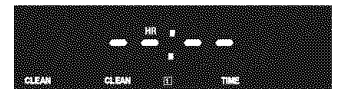

Figure 1

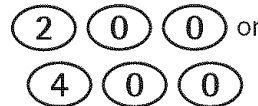

Figure 2



Figure 3



Figure 4



Figure 5



# Oven Cleaning

## To Start the delayed Self-Clean Cycle

The **FLEX CLEAN** (FLEX CLEAN), **DELAY START** (DELAY START) pads and length of clean cycle, controls the Delayed Self-Clean operation. The automatic timer will turn the oven **on and off** at the time you select in advance. Be sure to review **TO START THE SELF-CLEAN CYCLE** for recommended clean times.

### INSTRUCTIONS

#### To set the control for the Self-Cleaning Cycle to start at a delayed time and shut off automatically (example: 3 hour self-clean cycle to start at 4:30)

1. Be sure the clock is set with the correct time of day and the oven door is closed.
2. Press (FLEX CLEAN). "CLEAN", "ON" and "TIME" will flash in the display (Figure 1).
3. To enter 3 hour, press (3) (0) (0) on the numeric pad (Figure 2).
4. Press (START). "OVEN" will appear in the display. Once the door has locked "CLEAN", "LOCK" and "ON" will be displayed (Figure 3).
5. Press (DELAY START). Time will be displayed. "OVEN 1" and "TIME" will flash (Figure 4). Enter the desired start time using the number pads (4) (3) (0) (Figure 4).
6. Press (START). "CLEAN", "DELAY", "LOCK", "OVEN1" and "TIME" will be displayed (Figure 5).
7. As soon as the control is set, the motor driven oven door lock will begin to close automatically. Once the door has been locked the "LOCK" indicator light will go on.
8. The control will start the self-cleaning at the set start time, for the period of time previously selected. At that time, the icon "DELAY" will go out.

#### When the Self-Clean Cycle is Completed

1. The time of day and "END" will remain in the display (Figure 6).
2. Once the oven has cooled down for approximately 1 HOUR, and "END" is no longer displayed, the oven door can then be opened (Figure 7).

### PRESS

### DISPLAY



Figure 1



Figure 2



Figure 3



Figure 4



Figure 5



Figure 6



Figure 7

# Oven Cleaning

## INSTRUCTIONS

## PRESS

## DISPLAY

### Stopping or Interrupting a Self-Cleaning Cycle:

If it becomes necessary to stop or interrupt a self-cleaning cycle due to excessive smoke or fire in the oven:

1. Press .
2. Once the oven has cooled down for approximately 1 HOUR and the "LOCK" is no longer displayed, the oven door can then be opened (Figure 1).



Figure 1

Note: If your clock is set for normal 12 hour display mode the Delayed Self-Clean cycle can never be set to start more than 12 hours in advance. To set for Delayed Self-Clean Cycle 12-24 hours in advance set the control for the 24 hour time of day display mode.

## Adjusting Oven Temperature

The temperature in the oven has been pre-set at the factory. When first using the oven, be sure to follow recipe times and temperatures. If you think the oven temperature is cooking too hot or too cool for the temperature you select, you can adjust the actual oven temperature to be more or less than what is displayed. Before adjusting, test a recipe by using a temperature setting that is higher or lower than the recommended temperature. The baking results should help you to decide how much of an adjustment is needed.

**Note:** The oven temperature adjustments made with this feature will not change the Self-Clean cycle temperature.

## INSTRUCTIONS

## PRESS

## DISPLAY

### To adjust the oven temperature higher





1. Press  for 6 seconds (Figure 2).
2. To increase the temperature use the number pads to enter the desired change. (Example 30°F)   (Figure 3). The temperature may be increased as much as 35°F (19°C).
3. Press  or  to accept the temperature change and the display will return to the time of day (Figure 4).



Figure 2

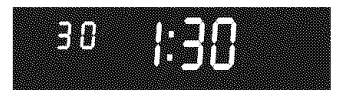

Figure 3



Figure 4

### To adjust the oven temperature lower







1. Press  for 6 seconds (Figure 5).
2. To decrease the temperature use the number pads to enter the desired change. (Example -30°F)   and then press  (Figure 6). The temperature may be decreased as much as -35°F (-19°C).
3. Press  or  to accept the temperature change and the display will return to the time of day (Figure 7).



Figure 4

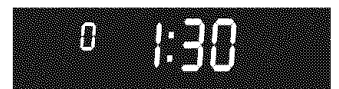

Figure 5



Figure 6



Figure 7

# General Care & Cleaning

## Cleaning Various Parts of Your Oven

Before cleaning any part of the oven, be sure all controls are turned OFF and the oven is COOL. REMOVE SPILLOVERS AND HEAVY SOILING AS SOON AS POSSIBLE. REGULAR CLEANING NOW WILL REDUCE THE EXTENT AND DIFFICULTY OF MAJOR CLEANING LATER.

Surfaces	How to Clean
Aluminum (Trim Pieces) & Vinyl	Use hot, soapy water and a cloth. Dry with a clean cloth. Do not scour or use all-purpose cleaners, ammonia, powdered cleaners or commercial oven cleaner. They can scratch and discolor aluminum.
Painted and Plastic, Control Knobs, Body Parts, and Decorative Trim	<p><i>For general cleaning</i>, use hot, soapy water and a cloth. <i>For more difficult soils and built-up grease</i>, apply a liquid detergent directly onto the soil. Leave on soil for 30 to 60 minutes. Rinse with a damp cloth and dry. <b>DO NOT</b> use abrasive cleaners on any of these materials; they can scratch.</p> <p>To remove control knobs, turn to the OFF position; grasp firmly and pull straight off the shaft. To replace knobs after cleaning, line up the flat sides of both the knob and the shaft; then push the knob into place.</p>
Stainless Steel, Chrome, Control Panel, Decorative Trim	<p><i>Before cleaning the control panel</i>, turn all controls to OFF and remove the control knobs. To remove, pull each knob straight off the shaft. Clean using hot, soapy water and a dishcloth. Rinse with a clean water using a dishcloth. Be sure to squeeze excess water from the cloth before wiping the panel; especially when wiping around the controls. Excess water in or around the controls may cause damage to the appliance. To replace knobs after cleaning, line up the flat sides of both the knob and the shaft; then push the knob into place.</p> <p>Clean <b>stainless steel</b> with hot, soapy water and a dishcloth. Rinse with clean water and a cloth. <b>Do not use cleaners with high concentrations of chlorides or chlorines.</b> Do not use harsh scrubbing cleaners. Only use kitchen cleaners that are especially made for cleaning stainless steel. Always be sure to rinse the cleaners from the surface as bluish stains may occur during heating that cannot be removed.</p>
Porcelain Enamel, Broiler Pan and Insert, Door Liner, Body Parts	Gentle scouring with a soapy scouring pad will remove most spots. Rinse with a 1:1 solution of clear water and ammonia. <i>If necessary</i> , cover difficult spots with an ammonia-soaked paper towel for 30 to 40 minutes. Rinse with clean water and a damp cloth, and then scrub with a soap-filled scouring pad. Rinse and wipe dry with a clean cloth. Remove all cleaners or the porcelain may become damaged during future heating. <b>DO NOT</b> use spray oven cleaners on the cooktop.

ENGLISH

### Oven Racks

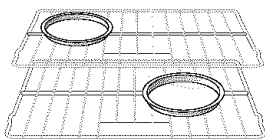

This oven comes with lubricated porcelain oven racks, which can remain in the oven during the self-clean cycle. Do not clean this vegetable oil lubrication off the racks. It is important that the sides of the oven racks always have a light coating of vegetable oil. To maintain optimal rack performance, re-apply a thin layer of vegetable oil to the sides of the rack after every self-clean cycle or when the rack becomes difficult to slide.

### Oven Door

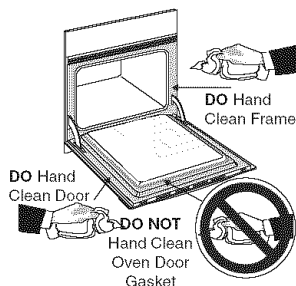

Use soap & water to thoroughly clean the top, sides and front of the oven door. Rinse well. You may use a glass cleaner on the outside glass of the oven door. **DO NOT** immerse the door in water. **DO NOT spray or allow water or the glass cleaner to enter the door vents.** DO NOT use oven cleaners, cleaning powders or any harsh abrasive cleaning materials on the outside of the oven door.

**DO NOT** clean the oven door gasket. The oven door gasket is made of a woven material, on Self-Cleaning models, which is essential for a good seal. Care should be taken not to rub, damage or remove this gasket.

# General Care & Cleaning

## Care and Cleaning of Stainless Steel (Some models)

Some models are equipped with stainless steel exterior parts. Special care and cleaning are **required** for maintaining the appearance of stainless parts. Please refer to the table provided at the beginning of the **General Care & Cleaning** section in this Use & Care Guide.

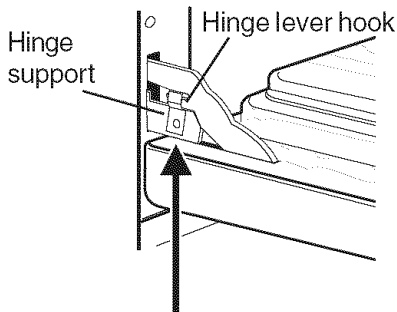

Lock engaged for door removal  
Figure 1

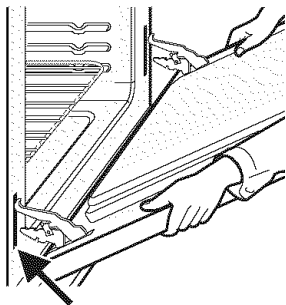

HINGE SLOT - Door removed  
from the oven  
Figure 2

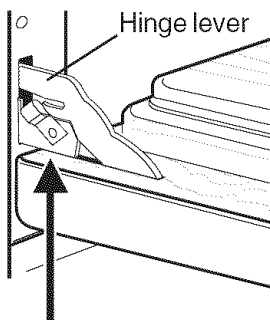

Lock in normal position  
Figure 3

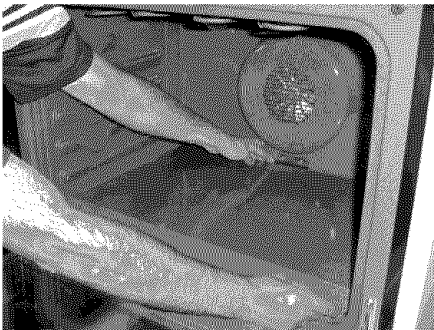

## Removing and Replacing the Oven Door

**CAUTION** The door is heavy. For safe, temporary storage, lay the door flat with the inside of the door facing down.

### To Remove Oven Door:

1. Open the door to the fully opened position.
2. Pull up the lock located on both hinge supports and engage it in the hinge lever hooks (Figure 1). You may have to apply a little downward pressure on the door to pull the locks fully over the hinge lever hooks.
3. Grab the door by the sides and pull the bottom of the door up and toward you to disengage the hinge supports. Keep pulling the bottom of the door toward you while rotating the top of the door toward the range to completely disengage the hinge levers (Figure 2).
4. To clean oven door, follow the instructions provided in the **General Care & Cleaning** table.

### To Replace Oven Door:

1. Grab the door by the sides; place the hinge supports in the hinge slots. Open the door to the fully opened position.
2. Disengage the lock from the hinge lever hooks on both sides (Figure 3).  
Note: Make sure the hinge supports are fully engaged before unlocking the hinge levers.
3. Close the oven door.

## Special Door Care Instructions

Most oven doors contain glass that can break.

Read the following recommendations:

1. Do not close the oven door until all the oven racks are fully in place.
2. Do not hit the glass with pots, pans, or any other object.
3. Scratching, hitting, jarring or stressing the glass may weaken its structure causing an increased risk of breakage at a later time.

## To remove the "hidden bake" cover

1. In order to remove the "hidden bake" cover, pull the back edge with one hand about 1/2" inch and lift up the "hidden bake" cover with both hands. (See picture)
2. When re-installing the "hidden bake" cover, be sure to put it all the way to the back of the oven and lay it down on the 2 shoulder screws. Then push the front edge of the cover in its place below the front bracket.

To have easier access to the "hidden bake" cover, first remove the oven door by following the instructions above.

**IMPORTANT:** Always replace the "hidden bake" cover before the next use.

## General Care & Cleaning

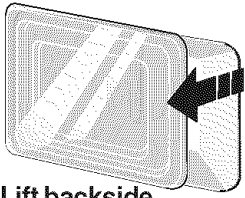

Lift backside of glass shield and remove it.

Halogen Light Bulb

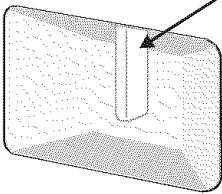

### Changing the Oven Light

An interior oven light will turn on automatically when the oven door is opened. The oven light may be turned on when the door is closed by using the oven light switch located on the control panel.

The lamp is covered with a glass shield. The glass shield can be removed to be cleaned manually or to change oven light. **THIS GLASS SHIELD MUST BE IN PLACE WHENEVER THE OVEN IS IN USE.**

**To replace the light bulb:**

**CAUTION: BE SURE THE OVEN IS COOL.**

1. Turn the power off at the main source.
2. Wear a leather-faced glove for protection against possible broken glass.
3. To remove the glass shield, pull the back side of the shield toward the inside of the oven in a manner to lift it up from the oven side.
4. The glass shield should come out easily by pushing a little toward front of the range.
5. Replace halogen light appliance bulb taking care not to touch the bulb with your bare fingers. Touching bulb with your skin can leave a film on the bulb that causes it to burn out quickly.
6. Replace glass shield in opposite order and manner of removal.

## Cooking Table

 <b>CONVECTION BAKE pad</b>	
Food Type	Decrease in normal cook times
Frozen foods, pies, pastries and pizza	15-25 %
Refrigerator cookies	15-35 %
Refrigerator biscuits	15-30 %
Rolls & Breads	20-25%
Fresh Pies/Pastries	10-20 %
Begin with the maximum reduction in cook time and adjust as needed.	
*Recommended reduction in cook time based on brands of food items tested. Cook time may vary with your specific brand of food item.	

# Before You Call

## Solutions to Common Problems

*Before you call for service*, review this list. It may save you time and expense. The list includes common occurrences that are not the result of defective workmanship or materials in this appliance.

OCCURRENCE	POSSIBLE CAUSE/SOLUTION
Oven Control Beeps and Displays any F code error (example F11).	Electronic control has detected a fault condition. Press <b>STOP/CLEAR</b> to clear the display and stop the beeping. Reprogram the oven. If a fault reoccurs, record the fault number. Press <b>STOP/CLEAR</b> and call Sears or another qualified servicer.
-door- is displayed.	The door was left open and controls set for self-cleaning cycle. Simply close the door.
Installation.	Place oven rack in center of oven. Place a level on the oven rack. Contact installing agent if rack and cabinet cutout flooring are not level.  Kitchen cabinet misalignment may make oven appear to be not level. Be sure cabinets are square and level. Contact cabinet maker to correct problem.
Entire oven does not operate.	When the oven is first plugged in, or when the power supply to the oven has been interrupted, the display will flash. The oven cannot be programmed until the clock is set.  Be sure electrical cord is securely connected into the electrical junction box.  Cord/plug is not installed and/or connected. Cord is not supplied with oven. Contact Sears or another qualified servicer.  Service wiring not complete. Contact Sears or another qualified servicer.  Power outage. Check house lights to be sure. Call your local electric company.  Short in cord/plug. Replace cord/plug.  Controls are not set properly. See instructions under <b>Setting Oven Controls</b> to set the controls.  House fuse has blown or circuit breaker has tripped immediately following installation. House fuse may not be fully engaged. Check fuse and screw or engage circuit breaker securely.  House fuse has blown or circuit breaker has tripped after the oven has been installed and previously operating. Sears or another qualified servicer.
Oven light does not work.	Burned-out or loose bulb. Follow the instructions under <b>Changing Oven Light</b> to replace or tighten the bulb.
Fan noise during cooking operation.	A cooling fan may automatically turn on and off to cool internal parts. This is normal, and the fan may continue to run even after oven is turned off.

# Before You Call

## Solutions to Common Problems

OCCURRENCE	POSSIBLE CAUSE / SOLUTION
<b>Oven smokes excessively during broiling.</b>	Oven door is closed. Door should be open during broiling.
	Meat too close to the broiler unit. Reposition the rack to provide more clearance between the meat and the broiler. Preheat broil element for quick searing operation.
	Meat not properly prepared. Remove excess fat from meat. Slash remaining fatty edges to prevent curling, but do not cut into the lean.
	Grid on broiler pan wrong-side up. Grease does not drain into broiler pan. Always place the grid on the broiler pan with the ribs up and the slots down to allow grease to drip into the pan.
	Broiler pan used without grid or grid cover with foil. <b>DO NOT</b> use the broiler pan without the grid or cover the grid with foil.
	Oven needs to be cleaned. Grease has built up on oven surfaces. Regular cleaning is necessary when broiling frequently. Old grease or food spatters cause excessive smoking.
<b>Poor baking results.</b>	Many factors affect baking results. See <b>Baking</b> for hints, causes and corrections. See <b>Adjusting Oven Temperature</b> .
<b>Self-cleaning cycle does not work.</b>	Make sure the oven door is closed.
	Controls not set properly. Follow instructions.
	Self-cleaning cycle was interrupted. Stop time must be set 2-4 hours past the start time. Follow steps under "Stopping or Interrupting a Self-Cleaning Cycle" in the Use & care Guide.
<b>Soil not completely removed after self-cleaning cycle is completed.</b>	Failure to hand clean oven frame and door liner outside the oven door gasket before starting the self-clean cycle. Hand clean burned on residue with a stiff nylon brush and water or a nylon scrubber. Be careful not to damage the oven gasket.
	Excessive spillovers in oven. Set the self-clean cycle for longer cleaning time.
<b>Flames inside oven or smoke from vent.</b>	Excessive spillovers in oven. This is normal, especially for high oven temperatures, pie spillovers or for large amounts of grease on bottom of oven. Wipe up excessive spillovers.

# Get it fixed, at your home or ours!

## Your Home

For repair – **in your home** – of **all** major brand appliances, lawn and garden equipment, or heating and cooling systems, **no matter who made it, no matter who sold it!**

For the replacement parts, accessories and owner's manuals that you need to do-it-yourself.

For Sears professional installation of home appliances and items like garage door openers and water heaters.

**1-800-4-MY-HOME® (1-800-469-4663)**

Call anytime, day or night (U.S.A. and Canada)

[www.sears.com](http://www.sears.com)    [www.sears.ca](http://www.sears.ca)

## Our Home

For repair of carry-in items like vacuums, lawn equipment, and electronics, call or go on-line for the location of your nearest

**Sears Parts & Repair Center.**

**1-800-488-1222**

Call anytime, day or night (U.S.A. only)

[www.sears.com](http://www.sears.com)

To purchase a protection agreement (U.S.A.)  
or maintenance agreement (Canada) on a product serviced by Sears:

**1-800-827-6655** (U.S.A.)

**1-800-361-6665** (Canada)

Para pedir servicio de reparación  
a domicilio, y para ordenar piezas:

**1-888-SU-HOGAR®**

(1-888-784-6427)

Au Canada pour service en français:

**1-800-LE-FOYER<sup>MC</sup>**

(1-800-533-6937)

[www.sears.ca](http://www.sears.ca)

The Sears logo is displayed in a large, bold, black serif font. The word "Sears" is written in a classic, slightly stylized font. Below the letters, there is a thin, curved line that underlines the word.

© Registered Trademark / <sup>TM</sup> Trademark / <sup>SM</sup> Service Mark of Sears Brands, LLC

© Marca Registrada / <sup>TM</sup> Marca de Fábrica / <sup>SM</sup> Marca de Servicio de Sears Brands, LLC

<sup>MC</sup> Marque de commerce / <sup>MD</sup> Marque déposée de Sears Brands, LLC

© Sears Brands, LLC