

VEVOR[®]

**RETRACTABLE
EXTENSION CORD REEL
USER MANUAL**



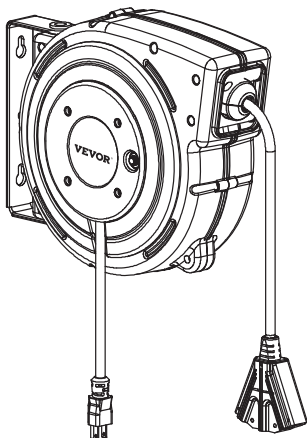

VEVOR[®]

RETRACTABLE EXTENSION CORD REEL

DL-610 45FT



ACCESSORIES

| NO. | Part name | QTY | Remark |
|-----|-----------------|-----|---|
| 1 | Bracket | 1 |  |
| 2 | Expansion screw | 4 |  |
| 3 | Wood screw | 4 |  |
| 4 | Set screw | 1 |  |

NEED HELP? CONTACT US!

Have product questions? Need technical support?
Please feel free to contact us:



CustomerService@vevor.com

This is the original instruction, Please read all manual instructions carefully before operating. VEVOR reserves clear interpretation of our user manual. The appearance of the product shall be subject to the product you received. Please forgive us that we won't inform you again if there is any technology or software updates on our product.

WARNING

◆ **Warning: To reduce the risk of fire, electric shock or personal injury, please strictly follow the instructions.**

1. Do not connect any devices which may exceed the maximum ratings of this cord reel.
2. Do not try to plug it in when your hands are wet or damp.
3. Never attempt to plug the cord reel into a non-grounded outlet.
4. When pulling the cord from the cord reel, grasp the reel's cord itself, but not the device or tool that the cord is plugged into.
5. Do not allow the cable to retract without restraining the retraction speed as damage or injury may occur from excessive rewind speed.
6. Inspect before every use; do not use if parts are loose or damaged or if insulation is worn.
7. Always unplug the retractable reel from its electrical outlet before performing any maintenance or changing accessories.
8. Do not connect wires randomly. Connect black wires with "L", white wires with "N", and green wires with "E".
9. When automatically retracting, a slow wire collection operation may lead to stagnation. The power cord needs to be pulled out a little, then release, and use its recovered inertia to completely retract the cable.
10. Do not disassemble the body of the reel.
11. Children are not allowed to use the cord reel.

OPERATION

1. Plug the lead-in cord into the grounded outlet.
2. Pull cord out to the desired length. Notice a clicking noise when pulling the cord. The cord will stay at the desired length during the clicking and rewind after a pull past the clicking noise.
3. To retract, pull the cord out and guide it slowly back into the reel.

SPECIFICATIONS

Cat. No. : DL-610

Input Voltage: 125VAC, 60Hz

Max Power Rating: 15A

Cord: 12AWG, SJTOW

Lead-in Cord Length: 4 1/2 FT

Length: 45 FT

ONE YEAR LIMITED WARRANTY

VEVOR warrants this product to be free from defects in material and workmanship for a period of one year from the date of purchase. Warranty is void if damage is caused by misuse or improper installation.

NOTE: Cord length is 45 feet long fully extended.
DO NOT keep on pulling the cord after it is fully extended.

INSTALLATION

- a. Check the wall or ceiling surface to which the retractable reel will be mounted to make sure they are sturdy enough to support the weight of the reel as well as the additional force when pulling on the outlet power cord.
 - b. Drywall will not hold the weight of the cord reel. It is necessary to locate a ceiling joist or wall stud.
1. Select a mounting location within 4 feet of an electrical outlet. The outlet for a garage door opener is ideal.
 2. Locate a wall or ceiling beam (use a stud finder, if needed) and fix the separate bracket to the wall or ceiling beam with cement screws or wood screws, see Figure 1.
 3. Slide the mounting bracket of the cord reel into the separate bracket, fix the set screw, see Figure 2.
 4. Adjust the cord stopper to a suitable position when required.

Figure 1

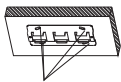

Mark with a pen according to the mounting position (Suitable for concrete materials)

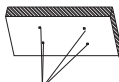

Drill four 45-50mm deep holes with 10mm drill bits

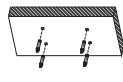

Install the expansion screws into the holes

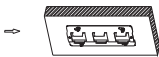

Install the bracket with the anchor bolt and tighten the nut

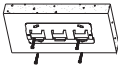

Install the bracket with wood screws (Suitable for wood)

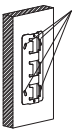

Mark with a pen according to the mounting position (Suitable for concrete)

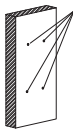

Drill four 45-50mm deep holes with 10mm drill bits

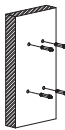

Install the expansion screws into the holes

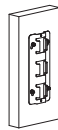

Install the bracket with the anchor bolt and tighten the nut

Install the bracket with the wood screws (Suitable for wood)



Figure 2

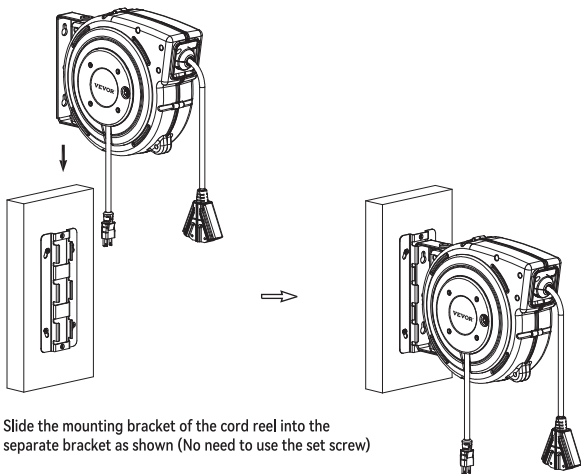

Slide the mounting bracket of the cord reel into the separate bracket as shown (No need to use the set screw)

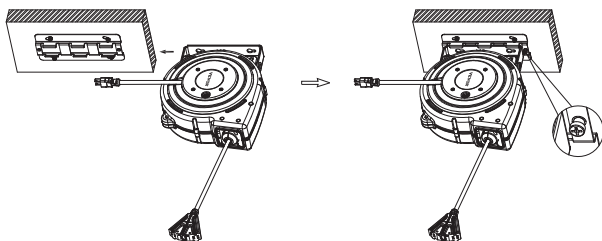

Slide the mounting bracket of the cord reel in the separate bracket as shown

Fix the set screw. (Please pay attention to the position of the set screw, do not fix it to another side or the cord reel will fall off.)



E-mail: CustomerService@vevor.com

Manufacturer: Longkou Dongli Wire and Cable Co.,Ltd.

Add: 413 Beihuan Rd,Huangcheng LongKou,Shandong,China.

Made in China

VEVOR[®]

E-mail: CustomerService@vevor.com