



## PRESSURE COOKER

ITEM # 99943, 99944, 99945



## OWNER'S MANUAL AND SAFETY INSTRUCTIONS

SAVE THIS MANUAL. KEEP THIS MANUAL FOR SAFETY WARNINGS, PRECAUTIONS, ASSEMBLY, OPERATION, INSPECTION, MAINTENANCE AND CLEANING PROCEDURES. WRITE THE PRODUCT'S SERIAL NUMBER ON THE BACK OF THE MANUAL, OR THE MONTH AND YEAR OF PURCHASE IF PRODUCT HAS NO SERIAL NUMBER

FOR QUESTIONS, PLEASE CALL CUSTOMER SERVICE: 909.628.4900

# SAFETY WARNINGS

## WARNING

**Read all safety warnings and instructions. Failure to follow the warnings and instructions may result in injury and/or property damage. Save all warnings and instructions for future reference.**

**The warning and safety instructions in this manual are not meant to cover all possible conditions and situations that may occur. Common sense, caution and care must be exercised when operating or cleaning tools and equipment. Always contact your dealer, distributor, service agent or manufacturer about problems or conditions you do not understand before operating the product.**

- Do not allow children or pets near the pressure cooker while in use.
- Do not put the pressure cooker into a hot oven.
- Move the pressure cook with care. Do not touch the hot surfaces of the pressure cooker. Use gloves when moving the pressure cooker.
- Never use your pressure cooker without adding water, this would seriously damage it.
- Do not fill the cooker beyond 2/3 of its capacity. When cooking foodstuffs which expand during cooking, such as rice or dehydrated vegetables, do not fill the cooker to more than half of its capacity.
- Use the appropriate heat source(s) according to the instructions for use.
- Before each use, check that the valves are not obstructed.
- Only use manufacturer's spare parts in accordance with the relevant model.
- Never cover pressure valves on the pressure cooker. An explosion can occur causing burns. Replacement of the pressure regulator is not recommended.
- Place the pressure regulator only when steam releasing from the vent pipe. Close supervision is necessary until the steam releases regularly from the pressure regulator.
- The safety valve emits excessive steam shows that the inside pressure rises over the safety pressure. Turn heat off immediately if this happens and let the pressure cooker cool down then check and clean the vent pipe and block-proof cover.
- This appliance is not intended for use by persons, including children with reduced physical, sensory and/or mental capabilities, or lack of experience and knowledge, unless they have been given supervision or instruction concerning use or supervision concerning use of the pressure cooker.
- Do not use the pressure cooker if it is damaged or deformed in any way. Return the pressure cooker to nearest authorized dealer or manufacturer. Contact customer service with any questions or concerns.
- Don't use this pressure cooker for deep-frying, and never place this pressure cooker in the oven, as this would destroy plastic and rubber parts and the safety mechanisms.
- Never use your pressure cooker without adding liquid, as this could result in damage from overheating to the cooker and the burner. Adhere strictly to the following content amounts: Minimum: 1/4 liter of liquid. Maximum: 2/3 of the volume of the pressure cooker. For foods which foam or rise (e.g. rice, legumes, broths, or dried vegetables), 1/3 of the volume of the cooker.

# SAFETY WARNINGS

- Pressure cookers are under pressure when in use. Not adhering to the Instructions for Use can lead to burns and scalding. Make sure that the cooker is properly closed, and never cover the Pressure limited valve before it is heated up.
- Keep an eye on the pressure cooker while cooking. If the steam escape through push proof valve, or rubber gasket escape through safety window, in this case, turn off the heat on your stove immediately and check the reason, solve the problem, then go on using.
- Move the pressure cooker very carefully when it is under pressure. Do not touch the hot outer surfaces of the pressure cooker, as you could burn yourself by doing so. Only touch the handles when cooking, and use potholder gloves when necessary.
- Pressure cookers must be shaken before opening to avoid pockets of steam, which might be caught within the food from spattering up and scalding you. Do not cook applesauce or stewed fruits in a pressure cooker
- Never try to force the pressure cooker open. Do not open it before you are certain that the steam inside has been expelled completely.
- Do not let the safety window aim at user while cooking. Always keep your hands, head and body out of the danger zone when releasing steam from the pressure cooker.
- Do not alter the safety mechanisms at random. Do not repair or oil the valves. If the pressure cooker-or any of its parts-is damaged or does not function as described in the Instruction for Use, do not use the pressure cooker. Let a professional repair it or get in touch with your retailer.
- Push proof valve: Only when the cooker is properly close, the pressure inside cooker should start to raise, then the Push-proof rod will rise to lock the lid.
- If the cooker is not closed properly, the pressure inside the cooker can't rise and the steam will always escapes from the Push proof valve. In this case, you should turn off the heat, close the cooker properly.
- Push proof valve can indicate the pressure state inside the cooker automatically. As long as the pressure inside the cooker is lower than the pressure that can engages the safety mechanism you can open the cooker safely Push-proof rod will fall back into its socket completely, then you just can open the cooker.
- Safety valve: When the Pressure limited valve doesn't work or can't work well and the pressure inside the cooker is too high, the Safety valve will work automatically, release redundant steam in the cooker, keep the pressure cooker at a safe level.
- Safety window: There is a safety window at the edge of the lid. When both the Pressure limited valve and Safety valve don't work and the pressure inside the cooker is too high, the rubber gasket will be extruded from this window, and it can depressurize the cooker quickly to the safe state.

**SAVE THESE WARNINGS.**

# SAFETY WARNINGS

## HOW PRESSURE COOKER WORKS

In the process of heating, the cooker is sealed by a silicon sealing ring, pressure in the cooker is increasing gradually, and boiling point of water is increasing accordingly. When pressure in the cooker exceeds the specified limit, the pressure regulator is pushing up, allowing steam to escape from the vent pipe keeping temperature and pressure inside the cooker at a certain level. If the escaping hole is blocked by food, one of the two safety valves will exhaust steam automatically for safety assurance. To ensure safe operation once lid is properly closed it will lock in this position when pressure reaches a certain point.

## TECHNICAL PARAMETERS

SKU	Diameter	Volume	Working Pressure	Safety Pressure (Phase 1)	Safety Pressure (Phase 2)
99943	9.45"	6 Qt	80kPa	120 - 150kPa	170 - 270kPa
99944	9.45"	8Qt	80kPa	120 - 150kPa	170 - 270kPa
99945	9.45"	10 Qt	80kPa	120 - 150kPa	170 - 270kPa

1. Cooker body
2. Lower handle
3. Sealing ring
4. Safety Valve
5. Clamp
6. Lid panel
7. Pressure Indicator
8. Lid
9. Turn Knob
10. Pressure limited valve
11. Vent pipe

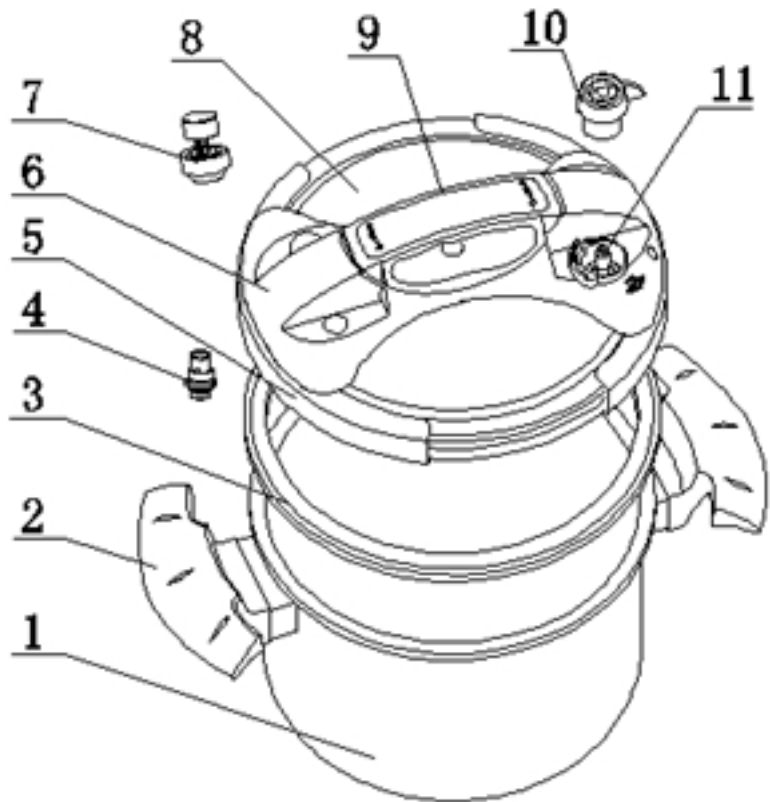

# SAFETY WARNINGS

## FEATURES OF PRESSURE COOKING:

1. Save time, preserves food up to 30%~70% faster than ordinary cooking methods.
2. Using less energy and saving more money. Keep kitchens cool and lower fuel bills. During the modern busy day, you can prepare a complete homemade gourmet meal in minutes.
3. Pressure cooking helps to retain your food essential nutrients. Cooking in an almost airless cooking environment with just a little liquid, Flavor is enhanced and food valuable vitamins and minerals are retained.

## OPENING THE PRESSURE COOKER:

Make sure the cooker is not pressured right to be opened, put it on a horizontal table or place and turn the turning handle toward the direction the arrow marked on the handle(open), until the turning handle and the lid control panel are in the shape of a cross. You will hear the sound 'KA'. then lift the lid.

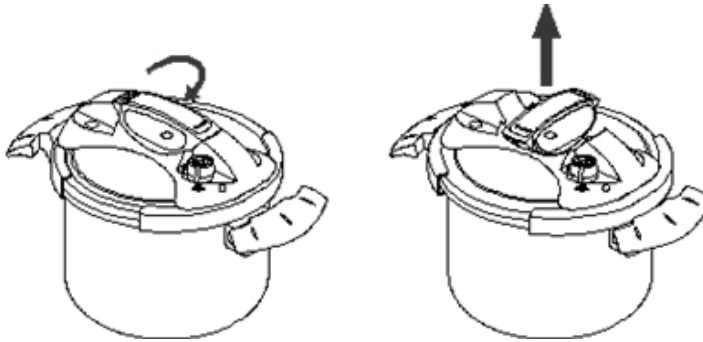

## CAUTION:

- Servicing or repair should only be completed by a qualified technician.
- Don't tamper with the pressure cooker, you may damage the safety systems and prevent their operation.
- Don't dismantle any part of the pressure cooker unless directed to do so in instructions.
- Using attachments not recommended or sold by the manufacturer may cause hazards. Only use original spare parts.

## PRIOR TO USING PRESSURE COOKER:

- Check to see that the Pressure limited valve, Block proof cover and Vent pipe does not stick and are in place in the lid and they will function properly.
- Check to see that the rubber gasket is correctly in place in the lid.

• Make sure that you always have the proper amount of liquid in the pressure cooker before it is closed.

Maximum volume: The maximum volume for common food is 2/3 of the cooker's capacity. For foods that swell or foam (e.g. legumes, rice, noodles, broths, or dried vegetables), the volume is then 1/3 of the cooker's capacity.

Minimum volume: Please remember that the cooker must always contain at least 1/4 liter of liquid when cooking.

- Using attachments not recommended or sold by the manufacturer may cause hazards. Only use original spare parts.

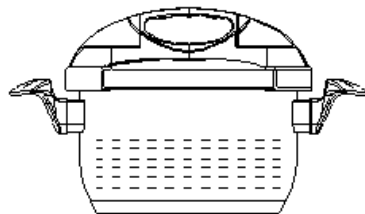

2/3 for common food

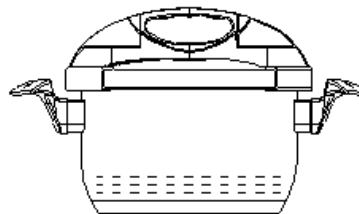

1/3 for swell or foam foods

## Use Capacity

Do not fill up the pressure cooker over 2/3 of its full capacity. When cooking foods that expand during cooking such as rice or dried vegetables, do not fill the unit over 1/2 full. Over filling may cause a risk of clogging the vent pipe and developing excess pressure.

# OPERATION

## Close and Open the Lid

Put the lid on the cooker body. At first, make sure the lid is in opening state. Then turn the turning handle toward the direction the arrow marked on the handle(close), until the turning handle and the lid control panel are in a line.



OPEN POSITION



CLOSE POSITION

**Important:** Always add enough liquid for steam to form, and make sure that the liquid in the pressure cooker does not evaporate completely. Never allow the cooker to “cook until dry.” As the resulting overheating could damage the cooker (e.g. melt the base or damage the safety mechanisms) and the burner. In case of overheating, never remove the cooker from the burner. Simply turn off the burner and let the cooker cool down for a while on it.

## To begin cooking

Place the pressure cooker on the proper burner; the diameter of burners should be always smaller than the diameter of pressure cookers. And make sure the releasing vent toward the working mark points, not toward the releasing mark points.



Working Mark Points



Releasing Mark Points

Always begin with the burner at high. When using a gas stove, make sure that the flame does not go beyond the edge of the pot base.

When cooking begins, the temperature rises and the process begins automatically. Steam escapes from Push proof valve, taking with it the oxygen in the air, which can destroy vitamins and minerals. This process may take a few minutes. The Push proof valve closes automatically. After few minutes, The first white ring on the indicator rod becomes visible.

- The 1st white ring on the indicator rod means that the pressure cooker is under pressure and can't be opened. It will be visible in the whole process of cooking.
- For the 2nd red ring, when the pressure cooker works normally, the red ring won't appear. If the red ring rises and appears in the process of cooking, It means the pressure is too high inside the cooker, in this case, turn down the heat and check the reason.

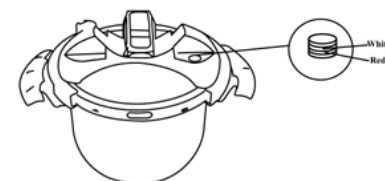
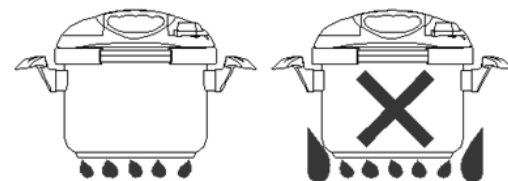

## To begin cooking

Place the pressure cooker on the proper burner; the diameter of burners should be always smaller than the diameter of pressure cookers. And make sure the releasing vent toward the working mark points, not toward the releasing mark points.

**NOTE:** If the 2nd red ring appears and continues to rise, you will hear a hissing sound, and the excess steam will escape through the Pressure limited valve. This means that the temperature is too high and the burner must be turned down, otherwise the liquid will evaporate completely.

## End of Heating

Remove the pressure cooker from the source of heat, reduce pressure before opening the lid. Set the cooker aside to a cool area and wait the cooker body cool down or for quicker reduction of pressure. Never force the cooker open. It may only be opened as long as the indicator rod has fallen back into its socket completely. Always shake the cooker before you open it. This will prevent pockets of steam, which might be caught within the food from spattering up when the pressure cooker is opened. If you do not do so, you are in serious danger of suffering burns and scalding by the escaping steam and food.

**WARNING:** Do not hold the pressure regulator to release pressure. (Risk of injuries! Hot steam/liquid will be ejected.) Keep hands and face away from steam vent pipe, use cooker handles when removing the cooker or touching any hot items, and never force the lid open. The lid will only open once the pressure is released. Remove the lid by lifting it away from you to avoid being burned by the steam.

# OPERATION

## WAYS TO RELEASE PRESSURE FROM THE COOKER:

### A. Cool the cooker under running water:

Hold the cooker under the water tap and run gently flowing cold water over the lid-but not over the lid control panel or pressure limited valve-until the Push-proof rod has fallen back into its socket completely. Do not place the cooker in water.



### B. Release steam

Move the pressure limited valve until the releasing vent toward the releasing mark points, the steam will stream out from the releasing vent on pressure limited valve. It may take several minutes. When the Push-proof rod has fallen back into its socket completely, no more steam is escaping from pressure limited valve. Then shake the cooker gently, open the cooker.

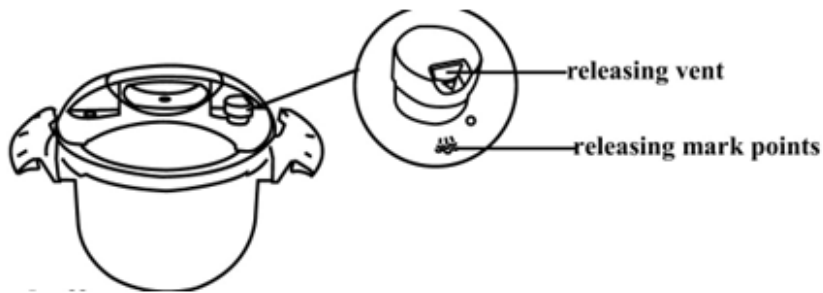

### C. Set aside to cool off

By this way, it takes quite a while for depressurizing. It should not be used for foods with very short cooking times, such as fish or vegetables, for they can easily become overcooked while the cooker is cooling down. When the Push-proof rod is no longer visible, shake the cooker gently when opening.

# MAINTENANCE

## VI. CLEANING/MAINTENANCE

### CLEANING

Once cook has finished, take the food out of the cooker. After the unit has cooled, remove the lid, clean the cooker in case that the food, especially acidic food, erodes in the cooker. Do not use abrasives to clean the pressure cooker.

### VENT PIPE AND BLOCK-PROOF COVER:

After each use, turn the lid over and place on a table top, then pull out the block-proof cover and clean it with water, if necessary, use a pin or something similar to clean the hole to ensure that there are not any food or foreign particles that may be lodged in the vent pipe and block-proof cover.

### SAFETY VALVE:

Every pressure cooker is equipped with safety valve, make sure both are workable before use cooker each time. Clean the base of the safety valve inside of the lid, check that it is working correctly by pressing lightly on the valve, which should give way easily. If not, replace with spare parts.

### CHANGE THE SEALING RING

Make sure that you buy the correct gasket for your model. After the pressure cooker is used, the sealing ring should be washed with hot water or detergent. Soak it in soapy water for a few seconds, then put it in position. Be careful not to fold or deform the sealing ring. Never shorten the gasket. If there are flaws on the sealing ring, or the sealing ring become old, please replace a new ring.

### FLOATING VALVE

Push down the rod with one hand; push the floating valve upward with the forefinger of the other hand to see if the floating valve works freely. If not, wash the floating valve assembly with water directly or dismantle the lid handle and then wash it. Replace it with floating valve assembly if necessary.

- How to replace the components in the lid handle If replacement is necessary, please insert spring first into the end of the push rod. Then put them both in the sliding groove of the lid handle. Finally screw the lid handle and the lid together.

### STORAGE OF YOUR PRESSURE COOKER

After use, clean and dry the cooker to keep. Turn the lid upside down on the body to ensure that pressure cooker lasts as long as possible.

### WARNING:

Do not use your pressure cooker to store acidic or salty food before and after cooking. Repair or other servicing should be performed only by a qualified technician or authorized service representative.

## RECOMMENDED COOKING TIMES (times may vary depending on weight and qty)

Seafood			
Time: min	Frozen Time: (*)		
Clams 4 (*N/A)	Crab Legs 2-3 (*4-5)	Crab (whole) 2-3 (*4-5)	Fish (fillet) 2-3 (*3-4)
Fish (steak) 3-4 (*4-6)	Fish (whole) 4-5 (*5-7)	Lobster 2-3 (*3-4)	Mussels 1-2 (*2-3)
Salmon 2-3 (*4-5)	Seafood Soup 7-8 (*8-9)	Shrimp 1-3 (*2-4)	Prawn 1-3 (*2-4)

Poultry			
Time: min			
Chicken (whole) 8 / lb N	Chicken (bone stock) 40-50 N	Chicken Breast (bone in) 12 Q	Chicken Breast (boneless) 6-8 Q
Chicken Thigh (bone in) 12 Q	Chicken Thigh (boneless) 6-8 Q	Cornish Game Hen 12-15 N	Duck (portions with bones) 12-15 Q
Duck (whole) 10-15 / lb Q	Turkey Breast (boneless) 7-9 N	Turkey Breast (whole) 20-25 N	Turkey Legs (drumsticks) 15-20 N

# COOKING TIME

## Beef

Time: min

Blade, Brisket, Chuck (large chunks) N 20-25 / lb	Blade, Brisket, Chuck (small chunks) N 15-20 / lb	Corned Beef Brisket (3 lb) N 55	Flank Steak (1 lb) N 25
Ground Beef (1 lb) Q 5	Meatballs Q 5 / lb	Oxtail N 35	Ribs N 20-25 / lb
Round, Rump, Steak (large chunks) N 20-25 / lb	Round, Rump, Steak (small chunks) N 15-20 / lb	Shanks N 25-30	Stew Meat N 20 / lb

## Pork

Time: min

Baby Back Ribs N 15-20 / lb	Butt Roast N 15 / lb	Chops (bone in, 1-inch) N 6	Chops (boneless, 1-inch) N 4-5
Ground Pork Q 5	Ham (picnic shoulder) N 8 / lb	Ham (slices) N 9-12	Loin Roast N 20 / lb
Sausages Q 10-15	Shoulder N 55	Spare Ribs N 45	Stew Meat N 15-20

## Other Meats

Time: min

Eggs (large) Q Hard: 5	Ground Lamb Q 5	Lamb (cubes) Q 10-15	Lamb (leg) N 15 / lb
Lamb (meatballs) N 5	Lamb Shanks N 30	Pheasant N 8 / lb	Quail (whole) Q 8 / lb
Veal (chops) N 5-8	Veal (roast) N 12 / lb	Veal Shanks N 20-25	Veal Stew Meat N 10

## Beans & Legumes

Dry Time Soaked Time: min min Liquid Ratio: (♠)

Adzuki/Azuki/Aduki N 16-20/4-6 (♠3x)	Anasazi N 20-25/5-7 (♠3x)	Black Beans N 16-20/6-8 (♠3x)	Black-Eyed Peas N 14-18/4-5 (♠3x)
Cannellini Beans N 30-35/6-9 (♠3x)	Chickpeas (garbanzo bean) N 35-40/10-15 (♠3x)	Great Northern Beans N 25-30/7-8 (♠3x)	Lentils (green) Q 8-10/N/A (♠3x)
Lentils (yellow) Q 1-2/N/A (♠3x)	Lima Beans N 12-14/6-10 (♠3x)	Navy Beans N 20-25/7-8 (♠3x)	Peas N 16-20/10-12 (♠3x)
Pigeon Peas (gandules) N 20-25/6-9 (♠2x)	Pinto Beans N 25-30/6-9 (♠3x)	Red Kidney Beans N 15-20/7-8 (♠3x)	Soy Beans N 35-45/18-20 (♠3x)

## Rice & Grains

Time: min Liquid Ratio: (♠)

Bulgur Q 20 (♠3x)	Couscous Q 2-3 (♠2x)	Farro Q 10-12 (♠2x)	Karmut (whole) Q 10-12 (♠2x)
Millet Q 10-12 (♠1.75x)	Oatmeal N 2-3 (♠2x)	Pearl Barley Q 20-22 (♠2.5x)	Quinoa Q 5 (♠2x)
Rice (Basmati, Jasmine) Q 4 (♠1x)	Rice (Brown) Q 20-22 (♠1x)	Rice (White) N 4 (♠1x)	Rice (Wild) Q 20-22 (♠2x)
Sorghum Q 20-25 (♠3x)	Spelt Berries Q 25-30 (♠1.5x)	Steel Cut Oats Q 3-5 (♠3x)	Wheat Berries Q 25-30 (♠3x)

## Vegetables

Fresh Time: min Frozen Time: (♠)

Artichoke (whole & trimmed) Q 9-11 (♠11-13)	Asparagus (whole or cut) Q 1-2 (♠2-3)	Beetroot (small / whole) Q 11-13 (♠13-15)	Brussel Sprouts (whole) Q 2-3 (♠3-4)
Butternut Squash (slices) Q 4-6 (♠6-8)	Cabbage (whole or wedges) Q 3-4 (♠4-5)	Carrots (sliced or shredded) Q 2-3 (♠3-4)	Cauliflower (florets) Q 2-3 (♠3-4)
Leeks Q 2-3 (♠3-4)	Okra Q 2-3 (♠3-4)	Potato, cubed (white / sweet) Q 3-4 (♠4-5)	Potato, whole (white / sweet) Q 12-15 (♠15-19)
Pumpkin (large pieces) Q 8-10 (♠10-14)	Pumpkin (small pieces) Q 4-5 (♠6-7)	Spaghetti Squash Q 12-15 (♠15-19)	Spinach Q 1-2 (♠2-3)

# TROUBLESHOOTING

Problem	Possible reason	How to correct problem
The Push-proof rod does not rise after heating a while.	(1) The cooker is not closed properly. (2) The heat is too low, the liquid haven't been boiled. (3) The airproof ring is dirty or damaged. (4) There is too little liquid in the cooker.	(1) Close the cooker properly. (2) Set the heat source at its highest setting. (3) Clean or replace the parts. (4) Add the minimum amount(1/4 liter) of liquid.
The escaping steam through Pressure limited valve can be heard, but cannot be seen.	(1) Pressure limited valve is blocked. (2) Vent pipe is blocked. (3) Cook until dry. (4) The stove is leaned .	(1) Clean or replace the parts. (2) Clean or replace the parts. (3) Turn off the heat immediately , after check the reason, then add the liquid. (4) Place the stove level.
The steam escapes from safety valve after the Push-proof rod rise.	(1) Vent pipe is blocked. (2) the food volume in the pressure cooker is overfilled. (3) The temperature is too high.	(1) Clean or replace the parts. (2) Get out the food from the cooker, then heat. (3) Turn down the heat after checking the food volume in the pressure cooker.
The steam escapes at the edge of the lid	(1) Pressure limited valve and safety valve wear out.. (2) The rubber gasket is incorrectly in place in the lid ◦ (3) The rubber gasket is damaged or hardened. (4) The rubber gasket is dirty (5) The cooker is not closed properly.	(1) Clean or replace the parts. (2) Place the rubber gasket in place in the lid correctly. (3) Insert a new gasket. (4) Clean or insert a new gasket. (5) Close the cooker properly.
It is not flexible while open and close the lid.	(1) The rubber gasket is not in correct size with the cooker. (2) Open the lid when the Push-proof rod hasn't fallen back into its socket completely. (3) Overexert when open and close the lid ,then some parts are damaged	(1) Insert a new gasket. In correct size. (2) When the Push-proof rod has fallen back into its socket completely, then open the lid. (3) Don't force the cooker open or closed. When it is not flexible while open and close the lid, please check the cooker at first, and then go on. If some parts are damaged, repair or replace the parts by professional man.

# OF NOTE

## PLEASE READ THE FOLLOWING CAREFULLY

THE MANUFACTURER AND/OR DISTRIBUTOR HAS PROVIDED THE PARTS LIST AND ASSEMBLY DIAGRAM IN THIS MANUAL AS A REFERENCE TOOL ONLY. NEITHER THE MANUFACTURER OR DISTRIBUTOR MAKES ANY REPRESENTATION OR WARRANTY OF ANY KIND TO THE BUYER THAT HE OR SHE IS QUALIFIED TO MAKE ANY REPAIRS TO THE PRODUCT, OR THAT HE OR SHE IS QUALIFIED TO REPLACE ANY PARTS OF THE PRODUCT. IN FACT, THE MANUFACTURER AND/OR DISTRIBUTOR EXPRESSLY STATES THAT ALL REPAIRS AND PARTS REPLACEMENTS SHOULD BE UNDERTAKEN BY CERTIFIED AND LICENSED TECHNICIANS, AND NOT BY THE BUYER. THE BUYER ASSUMES ALL RISK AND LIABILITY ARISING OUT OF HIS OR HER REPAIRS TO THE ORIGINAL PRODUCT OR REPLACEMENT PARTS THERETO, OR ARISING OUT OF HIS OR HER INSTALLATION OF REPLACEMENT PARTS THERETO.

**Record Product's Serial Number Here:** \_\_\_\_\_

**Note: If product has no serial number, record month and year of purchase instead.**

**Note: Some parts are listed and shown for illustration purposes only and are not available individually as replacement parts.**

## Questions, issues or missing parts?

Before returning to your retailer, our customer service team is here to help.



**Call Us: 909.628.0880**

**Email Us: [customer@bartonliving.com](mailto:customer@bartonliving.com)**

**Hours of Operation: 9am - 3pm PST Monday - Friday**

**MADE IN CHINA**