



# User Guide

## SUMMARY

This guide provides technical specifications and information about monitor features, setting up the monitor, and using the monitor.

## Legal information

© Copyright 2024, 2025 HP Development Company, L.P.

AMD, the AMD Arrow symbol, and FreeSync are registered trademarks or trademarks of Advanced Micro Devices, Inc. macOS is a trademark of Apple Inc., registered in the U.S. and other countries and regions.



For DTS patents, see <http://patents.dts.com>. Manufactured under license from DTS, Inc. or DTS Licensing Limited. DTS, DTS:X, Virtual:X, and the DTS:X logo are registered trademarks or trademarks of DTS, Inc. in the United States and other countries. © 2021 DTS, Inc. ALL RIGHTS RESERVED. Thunderbolt and the Thunderbolt logo are trademarks of Intel Corporation or its subsidiaries in the U.S. and/or other countries. Microsoft and Windows are either registered trademarks or trademarks of Microsoft Corporation in the United States and/or other countries. USB Type-C and USB-C are registered trademarks of USB Implementers Forum. VESA, DisplayPort™ and the DisplayPort™ logo are trademarks owned by the Video Electronics Standards Association (VESA) in the United States and other countries.

The information contained herein is subject to change without notice. The only warranties for HP products and services are set forth in the express warranty statements accompanying such products and services. Nothing herein should be construed as constituting an additional warranty. HP shall not be liable for technical or editorial errors or omissions contained herein.

### Product notice

This guide describes features that are common to most models. Some features may not be available on your product. To access the latest user guide, go to <http://www.hp.com/support>, and follow the instructions to find your product. Then select **Setup & User Guides**.

To help us improve this document, please send any suggestions, comments, or errors to <mailto:hp.doc.feedback@hp.com>. Include the document part number when submitting your feedback.

Second edition: January 2025

First Edition: April 2024

Document Part Number: N75807-002

---

# Table of contents

<b>1 About this guide</b>	<b>1</b>
<b>2 Getting started</b>	<b>2</b>
Important safety information	2
More HP resources	3
Preparing to call technical support	3
Getting to know your monitor	3
Features	3
Front components	5
Camera components (camera model only)	5
Rear components	6
Locating the serial number and product number	8
Setting up the monitor	9
Attaching the monitor stand	9
Mounting the monitor head	10
Removing the monitor stand	11
Attaching the monitor head to a VESA plate	11
Connecting the cables	13
Adjusting the monitor	19
Installing a security cable	21
Turning on the monitor	21
HP watermark and image retention policy	22
Connecting an HP notebook or desktop	23
USB Type-C Thunderbolt mode	23
<b>3 Using the monitor</b>	<b>24</b>
Downloading HP Display Center	24
Downloading software and utilities	24
The Information (INF) file	24
The Image Color Matching (ICM) file	25
Enabling AMD FreeSync Premium compatibility (select products only)	25
Using the OSD menu	25
Using the Joypad buttons	26
Reassigning the OSD menu options	27
Display mode status	27
Changing the Power Mode setting	28
Using Auto-Sleep Mode	28
Using PiP and PbP	28



Using the camera.....	29
Setting up Windows Hello facial recognition.....	30
Using the computer camera for Windows Hello.....	30
Using the monitor camera for Windows Hello.....	31
Setting up Auto Lock and Awake .....	31
Ambient light sensor .....	32
Multistreaming over USB Type-C Thunderbolt or DisplayPort ports.....	32
Using the split-screen function buttons .....	34
HP Device Bridge.....	36
Connect the cables.....	36
Download HP Device Bridge.....	37
Install HP Device Bridge.....	38
Enable settings for the split screen .....	38
Using HP Device Bridge .....	39
Transferring files and data.....	39
Stopping HP Device Bridge (Windows).....	40
Stopping HP Device Bridge (macOS).....	40
Connecting a second computer to the monitor using the KVM function.....	40
Toggle in KVM Mode.....	41
Connection priorities in KVM mode .....	41
Using Picture-by-picture (PbP).....	42
Setting up DTS Virtual:X for Audio.....	43
<b>4 Support and troubleshooting.....</b>	<b>44</b>
Using the self-test function .....	44
Internal test pattern generator .....	45
Solving common issues.....	46
Button lockouts .....	47
<b>5 Maintaining the monitor .....</b>	<b>48</b>
Maintenance guidelines.....	48
Cleaning the monitor .....	48
Shipping the monitor.....	49
<b>Appendix A Technical specifications .....</b>	<b>50</b>
86.4 cm (34 in) model specifications (WQHD).....	50
95.3 cm (37.5 in) model specifications (WQHD+).....	51
Preset display resolutions.....	52
86.4 cm (34 in) model (WQHD) .....	52
95.3 cm (37.5 in) model (WQHD+).....	53
Energy saver feature.....	54
<b>Appendix B Accessibility .....</b>	<b>55</b>
HP and accessibility.....	55







Finding the technology tools you need .....	55
The HP commitment.....	55
International Association of Accessibility Professionals (IAAP).....	56
Finding the best assistive technology.....	56
Assessing your needs .....	56
Accessibility for HP products.....	56
Monitor accessibility features (select products/regions only).....	57
Built-in accessibility features.....	57
Text to Speech.....	57
What is Accessibility Mode? .....	57
How do you turn Accessibility Mode on or off? .....	58
Standards and legislation .....	58
Standards.....	58
Mandate 376 - EN 301 549 .....	59
Web Content Accessibility Guidelines (WCAG).....	59
Legislation and regulations.....	59
Useful accessibility resources and links .....	59
Organizations .....	60
Educational institutions .....	60
Other disability resources .....	60
HP links .....	60
Contacting support.....	61
<b>Index.....</b>	<b>62</b>



---

# 1 About this guide

This guide provides technical specifications and information about monitor features, setting up the monitor, and using the software. Depending on the model, your monitor may not have all the features included in this guide.

- 
-  **WARNING!** Indicates a hazardous situation that, if not avoided, **could** result in serious injury or death.
  -  **CAUTION:** Indicates a hazardous situation that, if not avoided, **could** result in minor or moderate injury.
  -  **IMPORTANT:** Indicates information considered important but not hazard-related (for example, messages related to property damage). Warns the user that failure to follow a procedure exactly as described could result in loss of data or in damage to hardware or software. Also contains essential information to explain a concept or to complete a task.
  -  **NOTE:** Contains additional information to emphasize or supplement important points of the main text.
  -  **TIP:** Provides helpful hints for completing a task.
- 



This product incorporates HDMI® technology.

---

## 2 Getting started

Read this chapter to learn about safety information and where to find additional HP resources.

### Important safety information

An AC adapter and power cord might be included with the monitor. If you use another cord, use only a power source and connection appropriate for this monitor.

For information about the correct power cord set to use with the monitor, see the *Product Notices* at [HP Regulatory, Safety, Compliance, and Warranty Information](#).

---

 **WARNING!** To reduce the risk of electric shock or damage to the equipment:

- Plug the power cord into an AC outlet that is easily accessible at all times.
- If the power cord has a three-pin attachment plug, plug the cord into a grounded (earthed) three-pin outlet.
- Disconnect power from the monitor by unplugging the power cord from the AC outlet. When unplugging the power cord from the AC outlet, grasp the cord by the plug.

---

For your safety, do not place anything on power cords or cables. Take care to route all cords and cables connected to the monitor so that they cannot be stepped on, pulled, grabbed, or tripped over.

To reduce the risk of serious injury, read the *Safety & Comfort Guide* provided with your user guides. It describes proper workstation setup and proper posture, health, and work habits for computer users. The *Safety & Comfort Guide* also provides important electrical and mechanical safety information. The *Safety & Comfort Guide* is also available on the web at <http://www.hp.com/ergo>.

---

 **IMPORTANT:** For the protection of the monitor and the computer, connect all power cords for the computer and its peripheral devices (such as a monitor, printer, scanner) to a surge protection device such as a power strip or uninterruptible power supply (UPS). Not all power strips provide surge protection; the power strip must be specifically labeled as having this capability. Use a power strip whose manufacturer offers a damage replacement policy so that you can replace the equipment if surge protection fails.

---

Use the appropriate and correctly sized furniture designed to properly support your monitor.

---

 **WARNING!** Monitors that are inappropriately situated on dressers, bookcases, shelves, desks, speakers, chests, or carts could fall over and cause personal injury.

 **WARNING! Stability hazard:** The device might fall, causing serious personal injury or death. To prevent injury, securely attach the monitor to the floor or wall in accordance with the installation instructions.

 **WARNING!** This equipment is not suitable for use in locations where children are likely to be present.

 **NOTE:** This product is suitable for entertainment purposes. Consider placing the monitor in a controlled luminous environment to avoid interference from surrounding light and bright surfaces that might cause disturbing reflections from the screen.

---

## More HP resources

Use this table to locate resources that provide product details, how-to information, and more.

**Table 2-1** Additional information

Resource	Contents
Setup Instructions	Overview of monitor setup and features
HP support	For HP support or to resolve a hardware or software problem, perform one of these tasks: <ul style="list-style-type: none"><li>• Go to <a href="http://www.hp.com/support">http://www.hp.com/support</a>, and follow the instructions to find your product.</li><li>• Select the <b>Search</b> icon in the taskbar, type <code>support</code> in the search box, and then select <b>HP Support Assistant</b>.</li><li>• Select the question mark icon in the taskbar.</li></ul>



**NOTE:** Contact customer support to replace the power cord, the AC adapter (select products only), or any other cables that shipped with your monitor.

## Preparing to call technical support

Use this information if you have to troubleshoot an issue.

If you cannot solve a problem using [Support and troubleshooting on page 44](#), a call to technical support can provide additional help. Have the following information available when you call.

- Monitor model number
- Monitor serial number
- Purchase date on invoice
- Conditions under which the problem occurred
- Error messages received
- Hardware configuration
- Name and version of the hardware and firmware that you are using

## Getting to know your monitor

Your monitor has top-rated features. This section provides details about your components, where they are located, and how they work.

### Features

Depending on the model, your monitor might include the following features:

## Display features

- 86.4 cm (34 in) diagonal viewable screen area with 3440 × 1440 resolution (WQHD) or 95.3 cm (37.5 in) diagonal viewable screen area with 3840 × 1600 resolution (WQHD+), plus full-screen support for lower resolutions; includes custom scaling for maximum image size while preserving original aspect ratio
- Liquid crystal display (LCD) with active matrix and in-plane switching (IPS) Black Technology
- Wide color gamut to provide coverage of sRGB, Display P3, and BT.709 color spaces
- Nonglare panel with an LED backlight
- Wide viewing angle to allow viewing from a sitting or standing position, or moving from side to side
- Tilt, swivel, and height adjustment capabilities
- Internal speakers up to 76 dB with 200 Hz bass roll-off (WQHD)
- Dual Picture-in-Picture (PiP) and Picture-by-Picture (PbP) functionality to enable the USB Type C® Thunderbolt™, DisplayPort™, or HDMI inputs to be viewed where one image is overlaid onto another (PiP) or where one image is positioned adjacent to another (PbP)
- Five on-screen display (OSD) buttons, four that you can reconfigure to quickly allow selection of the most commonly used operations
- On-screen display (OSD) adjustments in several languages for easy setup and screen optimization
- Color space presets for Display P3
- Pantone Validated
- Compatible with displays software including Device Bridge 2.0
- Plug and Play capability, if supported by your operating system
- Energy saver feature to meet requirements for reduced power consumption
- Security cable slot on the rear of the monitor for an optional security cable
- Cable management feature for placement of cables and cords

## Connectors

- DisplayPort video input/output (cable included for select products only)
- High-Definition Multimedia Interface (HDMI) video input (cable included for select products only)
- USB Type-C Thunderbolt port (cable included)
- USB Type-C Thunderbolt DisplayPort output
- USB hub with one USB Type-C port that connects to the computer (upstream with full function) and six USB ports that connect to USB devices (downstream) (USB Type-C-to-USB Type-A cable included for select products only)
- RJ-45 (network) jack



## Monitor stand

- Removable stand for flexible monitor head mounting solutions
- HP Quick Release 2 device to quickly attach the monitor head to the stand with a simple click, and then remove it with the convenient sliding tab release
- VESA® mounting bracket for attaching the monitor head to a wall-mount device or swing arm
- Support for a mounting bracket to attach the monitor to a Mini Desktop or Mini Workstation

 **NOTE:** For safety and regulatory information, see the *Product Notices* provided in your documentation kit. To access the latest user guide, go to <http://www.hp.com/support>, and follow the instructions to find your product. Then select **Setup & User Guides**.

## Front components

To identify the components on the front of the monitor, use this illustration and table.

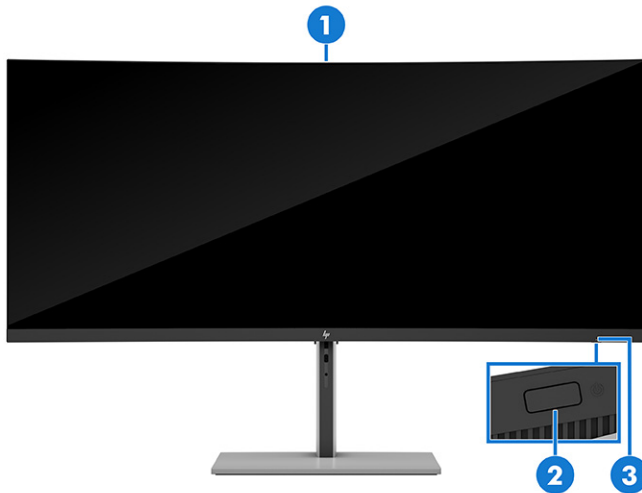
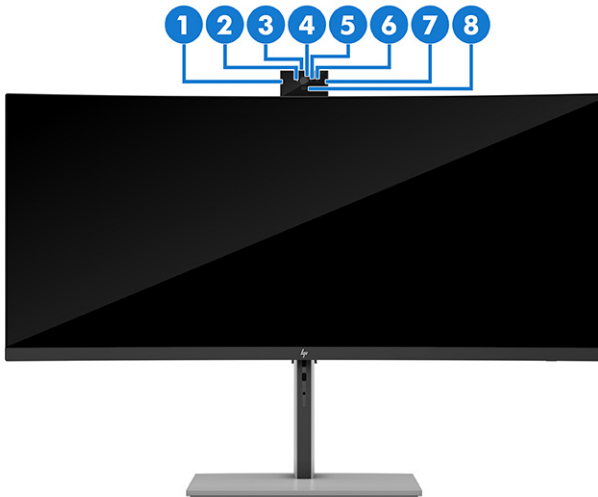

**Table 2-2** Front components and their descriptions

Component	Description
(1) Ambient light sensor	Adjusts the display brightness according to lighting conditions in the environment.
(2) Power button	Turns the monitor on or off.  <b>NOTE:</b> When applicable HP products are connected to the USB Type-C Thunderbolt port, pressing the power button on the display turns on/off your notebook, or puts it to sleep based on your power setting (Performance mode).
(3) Power LED	Indicates that the monitor is powered on or off.

## Camera components (camera model only)

To identify the components on the camera, use this illustration and table.

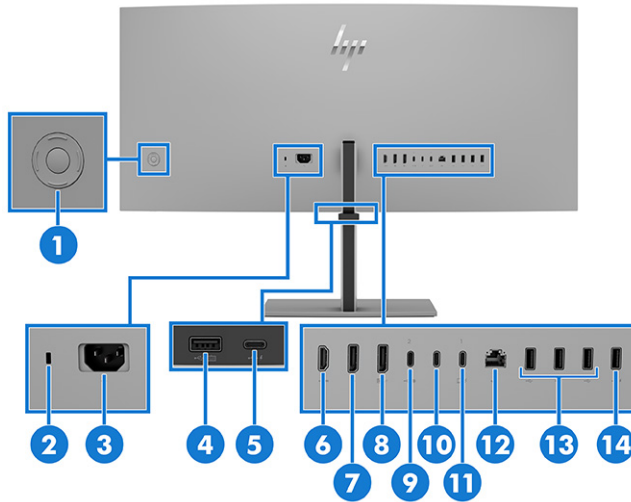

**Table 2-3** Camera components (camera model only)

	Component	Description
(1)	Microphone	Features active noise cancellation.
(2)	Webcam LED	Indicates that the webcam is powered on.
(3)	Ambient light sensor (top)	Adjusts the display brightness according to lighting conditions in the environment.
(4)	RGB camera	Allows you to perform RGB video recording.
(5)	Infrared webcam	Allows you to use Windows Hello for facial recognition and provides better operation in low-light situations.
(6)	Infrared LED	Indicates the status of the infrared webcam.
(7)	Microphone	Features active noise cancellation.
(8)	User proximity sensor	Uses the Auto Lock and Awake feature to monitor your presence in front of the computer to save power and add security. When you step away from the computer, the proximity sensor puts the computer into the Sleep state. When you return to the computer, your computer recognizes you and wakes the computer automatically. Auto Lock and Awake is turned on by default. If you also want to set up facial recognition login for Auto Lock and Awake, see <a href="#">Setting up Auto Lock and Awake on page 31</a> .

## Rear components

To identify the components on the rear of the monitor, use this illustration and table.



**Table 2-4 Rear components and their descriptions**

Component	Description
(1) Joypad	Press to open the OSD settings.
(2) Security cable slot	Connects an optional security cable.
(3) Power connector	Connects a power cord.
(4) USB Type-A port (includes KVM connection)	Connects a USB cable to a peripheral device, such as a keyboard, mouse, or USB hard drive, and charges peripheral devices. This is the dedicated USB Type-A port for KVM functions. It supports the KVM hot-key function on a keyboard that is connected to this port.
(5) USB Type-C port (BC 1.2)	Connects a USB Type-C cable to a peripheral device, such as a keyboard, mouse, or USB hard drive and charges up to 5 V/3 A.
(6) HDMI port	Connects the HDMI cable to a source device such as a computer.
(7) DisplayPort	Connects the DisplayPort cable to a source device such as a computer.
(8) DisplayPort OUT connector	Connects the monitor to another monitor for multistreaming.  <b>NOTE:</b> To remove the DisplayPort cable from the DisplayPort OUT connector, remove the following cables in the order shown: <ol style="list-style-type: none"> <li>1. HDMI cable (if connected)</li> <li>2. DisplayPort cable from the DisplayPort IN port (if connected)</li> <li>3. DisplayPort cable from the DisplayPort OUT port</li> </ol>
(9) USB Type-C DisplayPort port 2 (upstream)	Connects a Thunderbolt or USB Type-C DisplayPort cable to a source device such as a computer or game console. This USB Type-C port can function as a DisplayPort input or as a USB 3.0 connection. It can also be used to deliver up to 65 W of power to a device. Power outputs are 20 V/3.25 A, 15 V/4.33 A, 12 V/5 A, 9 V/3 A, or 5 V/3 A to achieve a 65 W output.  This port also enables the USB Type-A ports to perform their functions.
(10) USB Type-C Thunderbolt output port	Connects the monitor to another monitor for multistreaming.

**Table 2-4 Rear components and their descriptions (continued)**

Component	Description
(11) USB Type-C Thunderbolt port 1 (upstream)	<p>Connects a Thunderbolt or USB Type-C DisplayPort cable to a source device such as a computer or game console. This Thunderbolt port can function as a DisplayPort input or as a USB 3.0 connection. It can also be used to deliver up to 100 W of power to a device. Power outputs are 20 V/3.25 A, 15 V/4.33 A, 12 V/5 A, 9 V/3 A, or 5 V/3 A to achieve a minimum 65 W output.</p> <p>This port also enables the USB Type-A ports to perform their functions.</p>
(12) RJ-45 (network) jack	<p>Network (RJ-45) data rate via USB Type-C max speed is 1000 Mbps</p> <ul style="list-style-type: none"><li>• Green (left): The network is connected.</li><li>• Amber (right): Activity is occurring on the network.</li></ul> <p><b>NOTE:</b> Supports IT Manageability, out-of-band Wake on Lan (WOL) , out-of-band Mac Address Passthrough (MAPT), and PXE boot (HP models only). The functionality may vary with PC settings.</p> <p><b>NOTE:</b> This network port is fully energy efficient according to IEEE standards (IEEE 802.3az-2010) as long as all connected devices support this feature.</p>
(13) USB Type-A ports (3)	<p>Connect a USB cable to a peripheral device, such as a keyboard, mouse, or USB hard drive.</p> <p><b>NOTE:</b> This port also serves as the dedicated port for the Text-to-Speech (TTS) adapter (the first USB Type-A port from left to right).</p>
(14) USB Type-A port (BC 1.2) (downstream)	<p>Connects a USB cable to a peripheral device, such as a keyboard, mouse, or USB hard drive.</p>

## Locating the serial number and product number

Depending on the product, the serial number and product model number are located on a label on the rear of the monitor or on a label under the front bezel of the monitor head. You might need these numbers when you contact HP for support.

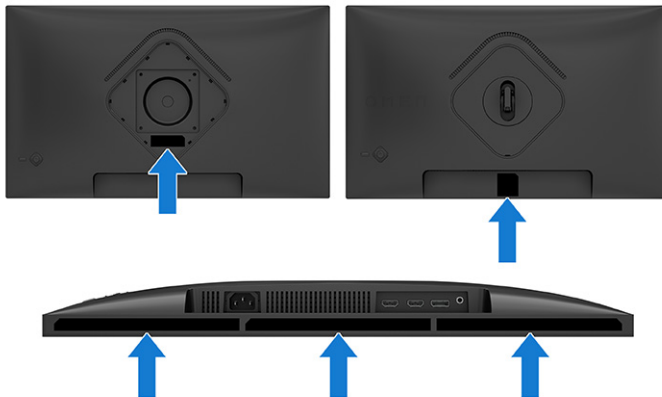

# Setting up the monitor

This section describes attaching the monitor stand or wall mount and the options for connecting your monitor to a PC, notebook, gaming console, or similar device.

- ⚠ WARNING!** To reduce the risk of serious injury, read the *Safety & Comfort Guide*. It describes proper workstation setup and proper posture, health, and work habits for computer users. The *Safety & Comfort Guide* also provides important electrical and mechanical safety information. The *Safety & Comfort Guide* is available on the web at <http://www.hp.com/ergo>.
- 📄 IMPORTANT:** To prevent damage to the monitor, do not touch the surface of the LCD panel. Pressure on the panel can cause nonuniformity of color or disorientation of the liquid crystals. If this occurs, the screen will not recover to its normal condition.
- 📄 IMPORTANT:** To prevent the screen from getting scratched, defaced, or broken and to prevent damage to the control buttons, position the monitor facedown on a flat surface covered with protective sheet foam or a nonabrasive cloth.

## Attaching the monitor stand

Correctly attaching your monitor stand is critical for safe use. This section describes how to safely attach a stand.

- 💡 TIP:** Consider the placement of the monitor, because surrounding light and bright surfaces might cause interfering reflections.
- 📄 NOTE:** The procedures for attaching a monitor stand might be different on other models.
- 📄 NOTE:** Leave the monitor in the box to protect the screen.

1. Open the box so that the monitor head is facedown in the box.
2. Remove the protective covering from the monitor.
3. Position the monitor stand on the mounting plate on the rear of the monitor, and then snap the monitor stand into place.

The latch on the stand clicks when you lock the stand in place.

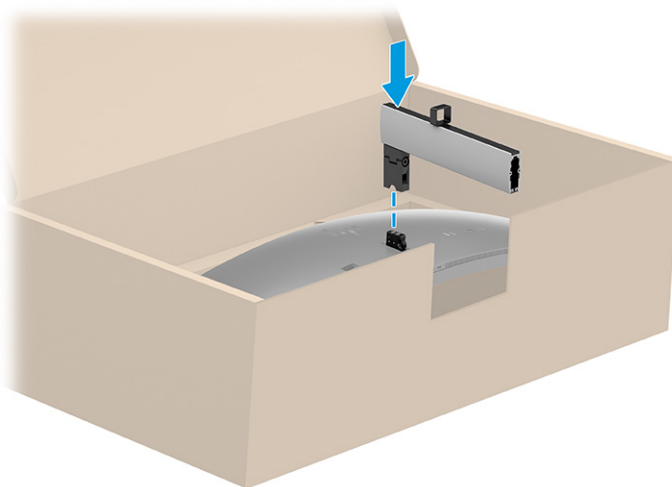

4. Attach the base to the monitor stand (1), and then tighten the screws (2).

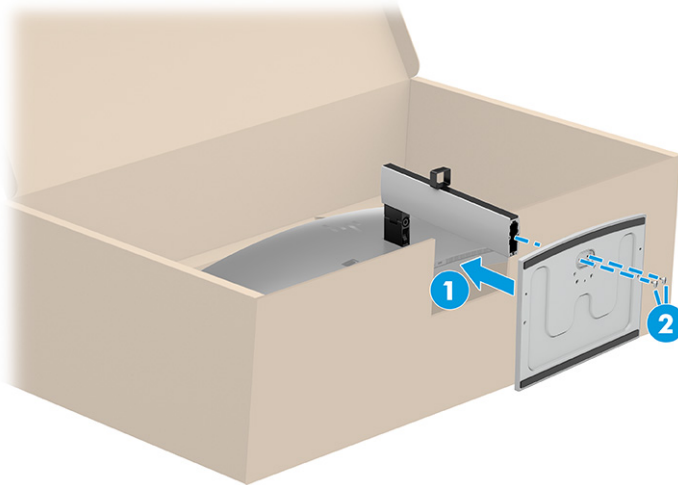

**⚠ CAUTION:** Use caution when lifting the monitor from the box because the monitor is very heavy.

**📋 IMPORTANT:** When you are removing the curved monitor from the box, be sure that you place both hands on the stand to lift the monitor.

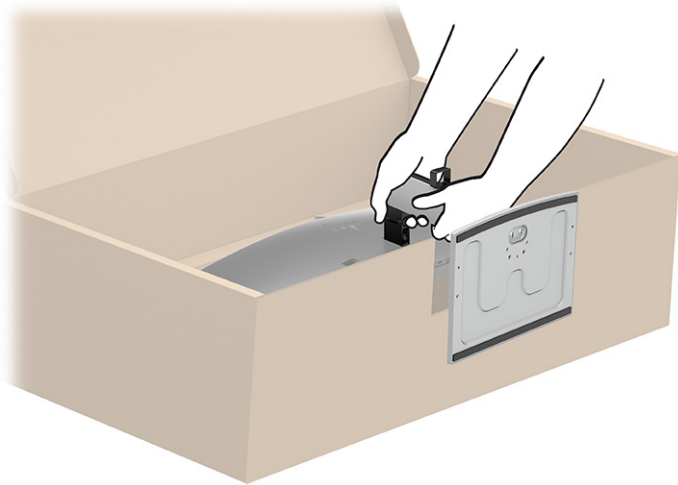

## Mounting the monitor head

To attach your monitor to a wall using a swing arm or other mounting fixture, follow the steps in this section to safely and securely connect your monitor.

**📋 IMPORTANT:** This monitor supports the VESA industry-standard 100 mm mounting holes. To attach a third-party mounting solution to the monitor head, use four 4 mm, 0.7 pitch, and 10 mm long screws (M4 × 10L). Longer screws might damage the monitor. Be sure that the manufacturer's mounting solution is compliant with the VESA standard and is rated to support the weight of the monitor head. For best performance, use the power and video cables provided with the monitor.

**📋 NOTE:** This apparatus is intended to be supported by a UL-listed, CSA-listed, or GS-listed wall-mount bracket.

## Removing the monitor stand

If you decide to use a wall mount instead of the monitor stand that you attached, first remove the stand.

 **IMPORTANT:** Before you disassemble the monitor, be sure that the monitor is turned off and all cables are disconnected.

 **IMPORTANT:** To position and stabilize the monitor, HP recommends that two people perform these procedures.

1. Disconnect and remove all cables from the monitor.
2. Position the monitor facedown on a flat surface covered by protective sheet made of foam or a clean, dry cloth.
3. Push up the latch or screw near the bottom center of the stand where it attaches to the monitor (1).
4. Remove the stand (2).

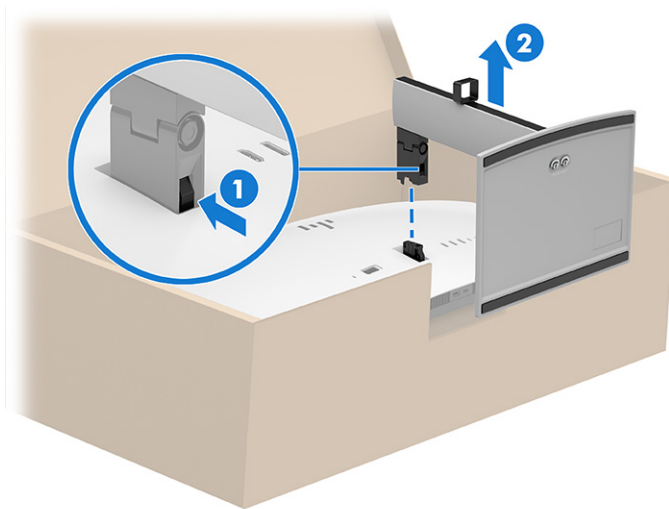

## Attaching the monitor head to a VESA plate

You might need additional tools such as a screwdriver (purchased separately) when you attach a VESA plate. To avoid damage to your monitor, follow these instructions.

1. Push the monitor stand upward.

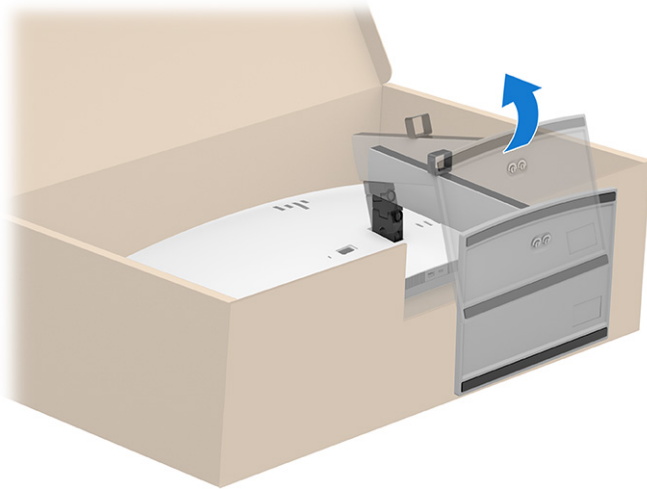

2. Remove the monitor stand.
3. Remove the two screws from the stand connector (1), and then lift it up (2) to remove it from the monitor.

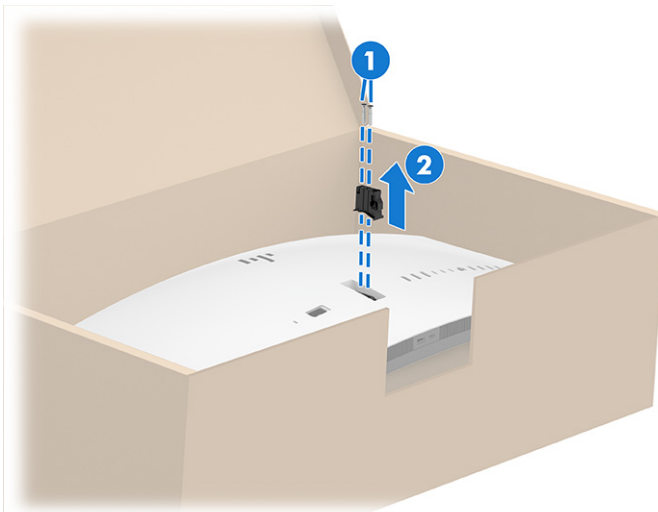

- Center the VESA plate on the stand connector (1), and then fasten the two screws (2) to the stand connector to hold the VESA plate in place.

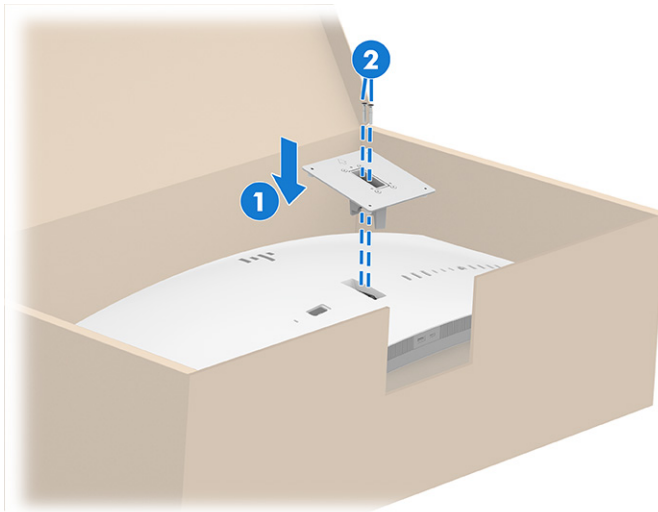

- If you are attaching the monitor to a swing arm or to a wall, you must complete the installation by following the instructions provided by the manufacturer.

## Connecting the cables

In addition to details about how to connect a cable, this section contains information about how your monitor functions when you connect certain cables.

 **NOTE:** Depending on the model, the monitor might be capable of supporting USB Type-C Thunderbolt, HDMI, or DisplayPort inputs. The video mode is determined by the video cable used. The monitor automatically determines which inputs have valid video signals. You can select the inputs through the OSD menu. The monitor ships with select cables. Not all cables shown in this section are included with the monitor.

- Place the monitor in a convenient, well-ventilated location near the computer.
- Connect one end of the power cord to the power connector on the monitor and the other end to a grounded AC outlet.

 **WARNING!** To reduce the risk of electric shock or damage to the equipment:

- Do not disable the power cord grounding plug. The grounding plug is an important safety feature.
- Plug the power cord into a grounded (earthed) AC outlet that is easily accessible at all times.
- Disconnect power from the equipment by unplugging the power cord from the AC outlet.

For your safety, do not place anything on power cords or cables. Arrange them so that no one can accidentally step on or trip over them. Do not pull on a cord or cable. When unplugging the power cord from the AC outlet, grasp the cord by the plug.

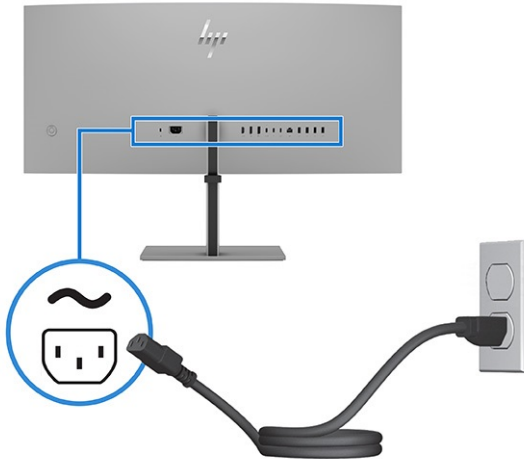

3. Connect a video cable.

**NOTE:** To enable the USB Type-A ports and USB Type-C port (downstream), connect the USB Type-C Thunderbolt cable or the USB Type-C-to-USB Type-A cable from the source device to the Thunderbolt input port or the USB Type-C (upstream) port at the rear of the monitor. This connection serves as a USB hub for a mouse, keyboards, phones, external hard drives, and anything else that is connected via a USB port.

- Connect one end of a Thunderbolt cable to the Thunderbolt port 1 on the rear of the monitor and the other end to the Thunderbolt port on the source device. Use only the HP-approved Thunderbolt cable provided with the monitor.

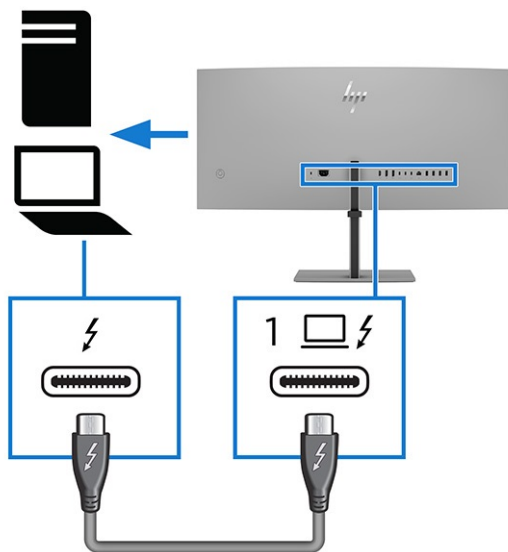

**NOTE:** The monitor's Thunderbolt port provides network, data, video, and power delivery (up to 100 W).

The host device must be able to support DisplayPort Alt Mode (video, charging, and USB 3.2) over the Thunderbolt connector. The host device must also be compatible with USB Type-C, Thunderbolt-enabled ports.

- Connect one end of a Thunderbolt cable to the USB Type-C port 2 on the rear of the monitor and the other end to the USB Type-C on the source device. Use only the HP-approved Thunderbolt cable provided with the monitor.

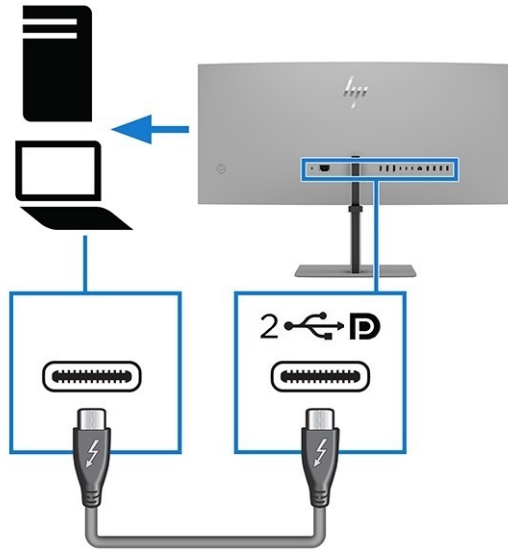

- Connect one end of an HDMI cable to the HDMI port on the rear of the monitor and the other end to the HDMI port on the source device. Connect one end of a USB-C-to-A cable to the USB-C port 2 (upstream) or USB Type-C Thunderbolt port 1 on the rear of the monitor and the other end to the USB-A on the source device.

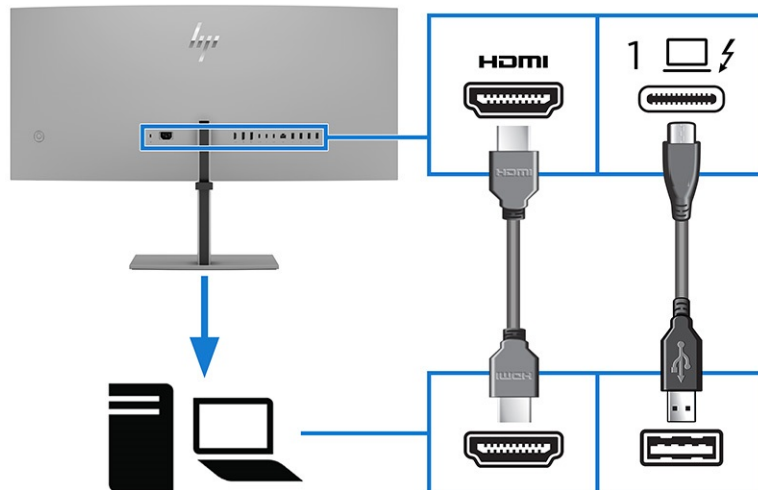

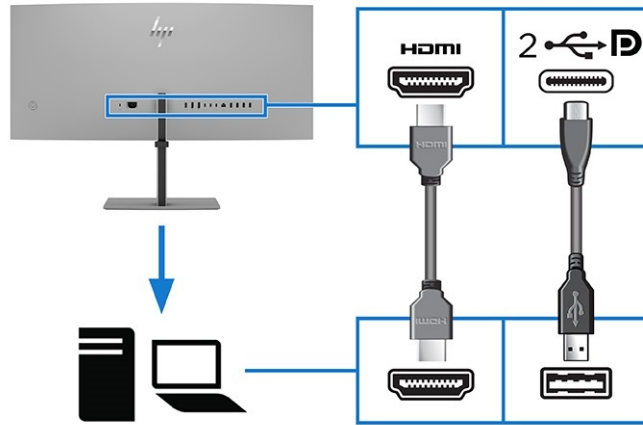

- Connect one end of a DisplayPort cable to the DisplayPort port on the rear of the monitor and the other end to the DisplayPort connector on the source device. Connect one end of a USB Type-C-to-A cable to the USB Type-C port 2 (upstream) or USB Type-C Thunderbolt port 1 on the rear of the monitor and the other end to the USB Type-A port on the source device.

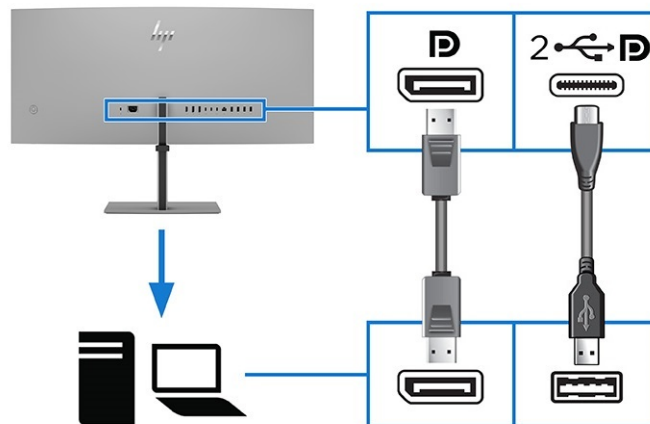
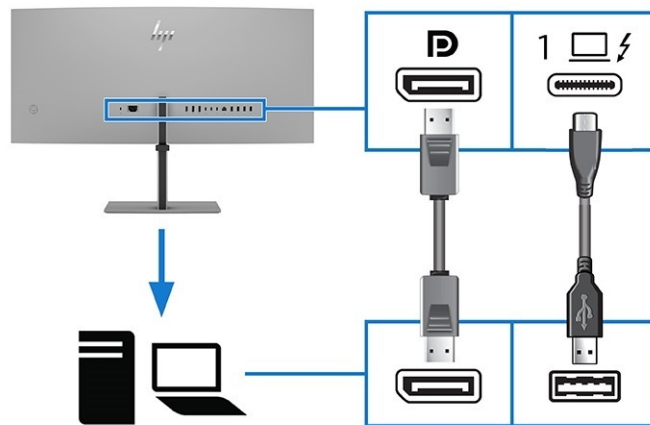

- Add a second monitor by connecting the cables using one of the following configurations:

- Connect a USB Type-C Thunderbolt cable between the USB Type-C Thunderbolt OUT port on the primary monitor and the USB Type-C Thunderbolt input port on a secondary monitor
- Connect a DisplayPort cable between the DisplayPort OUT port on the primary monitor and the DisplayPort IN port on a secondary monitor

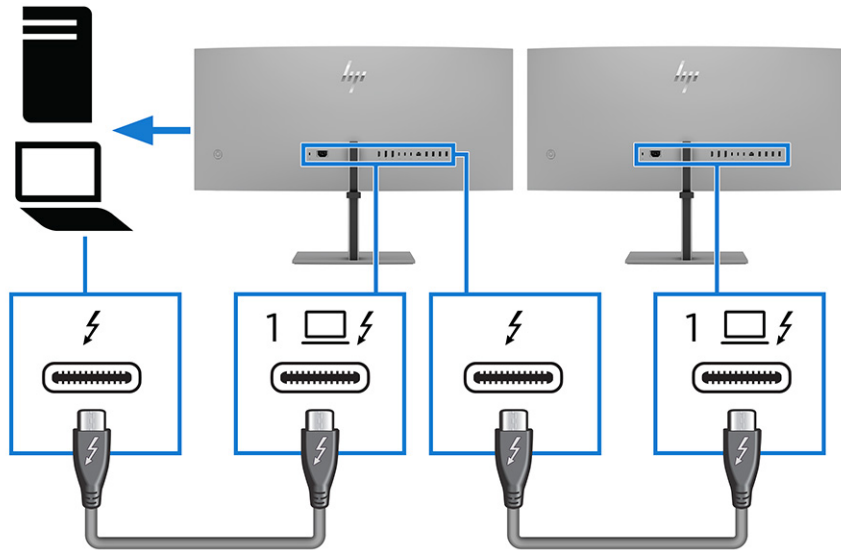
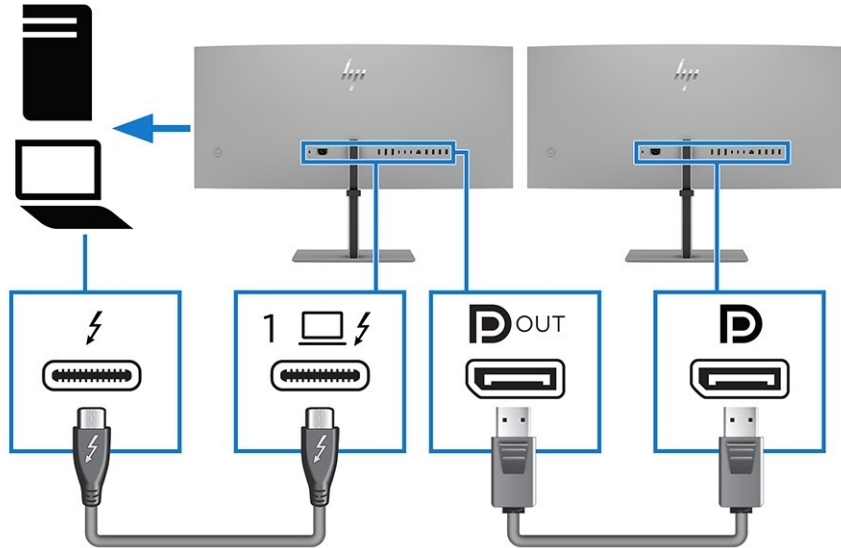

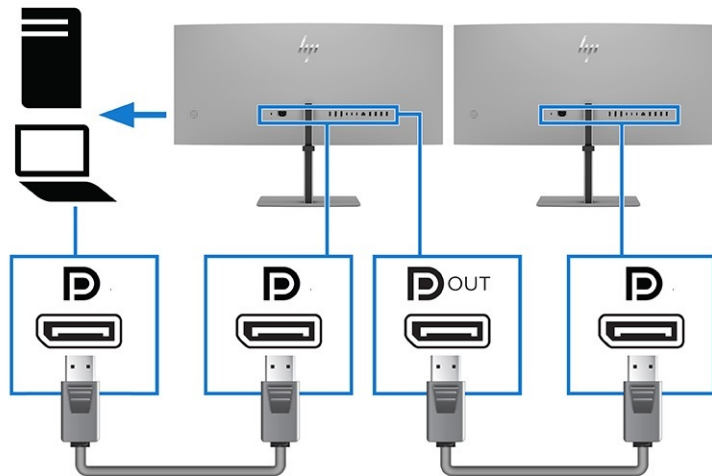
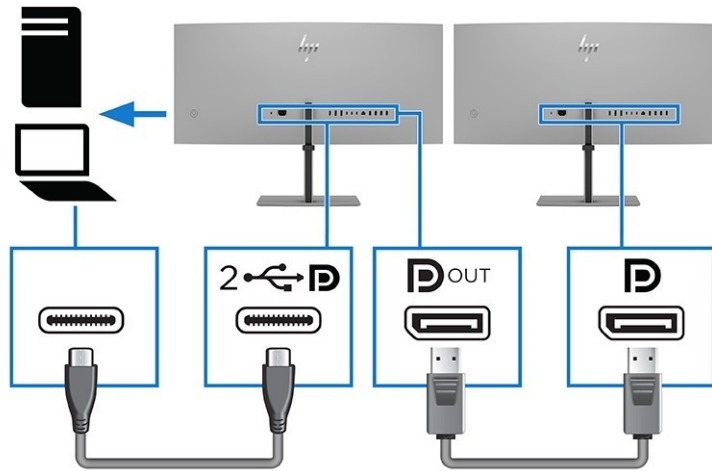

4. Use the USB Type-A on the rear of the monitor or USB Type-C ports (downstream) on the bottom of the monitor to connect devices such as the ones shown below.

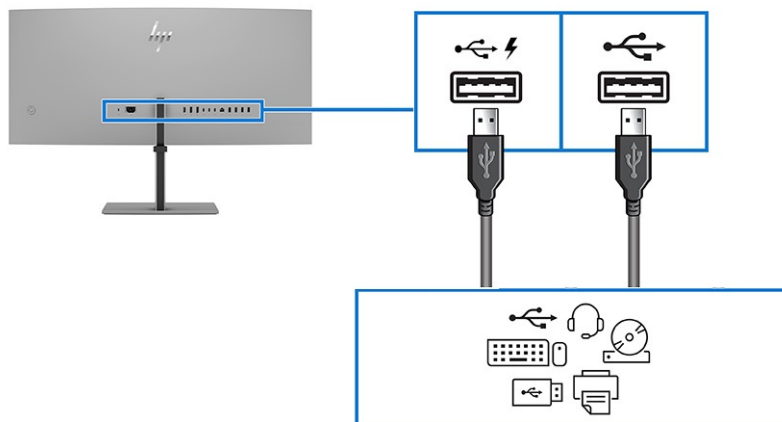

5. Use the USB Type-A port or USB Type-C port (downstream) on the bottom of the monitor to connect devices such as the ones shown below.

If you are connecting two computers to the monitor, connect a keyboard to the dedicated USB Type-A keyboard port to use a hotkey on the keyboard to switch between the computers.

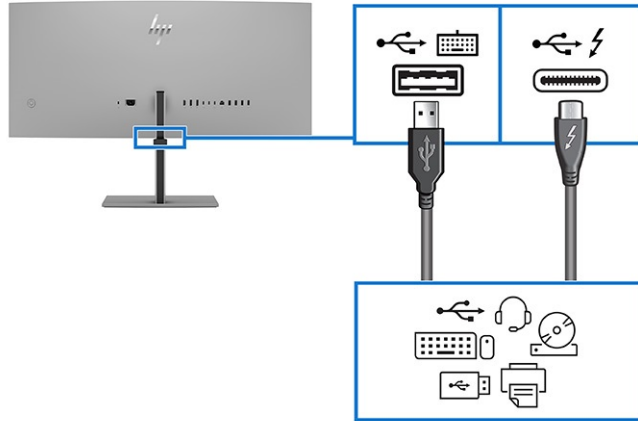

6. Connect one end of a network cable to the network jack on the monitor and the other end to a network wall jack or router.

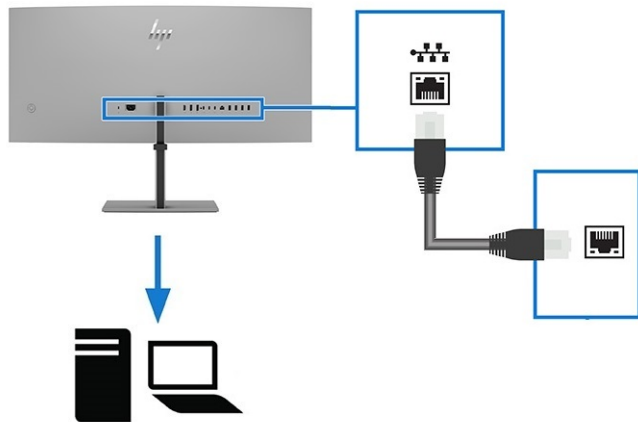

## Adjusting the monitor

To support an ergonomic work space, your monitor offers the adjustment options outlined in this section.

- ⚠ WARNING!** To reduce the risk of serious injury, read the *Safety & Comfort Guide*. It describes proper workstation setup and proper posture, health, and work habits for computer users. The *Safety & Comfort Guide* also provides important electrical and mechanical safety information. The *Safety & Comfort Guide* is available on the web at <http://www.hp.com/ergo>.

1. Tilt the monitor head forward or backward to set it to a comfortable eye level.

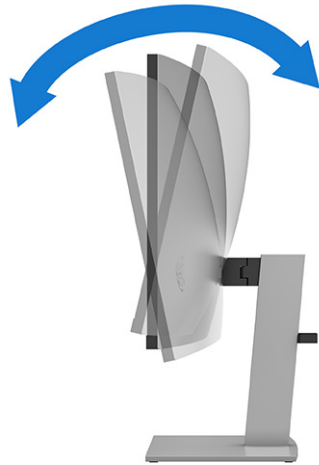

2. Adjust the monitor's height to a comfortable position for your individual workstation. The monitor's top bezel edge should not exceed a height that is parallel to your eye height. A monitor that is positioned low and reclined might be more comfortable for users with corrective lenses. Reposition your monitor as you adjust your working posture throughout the work day.

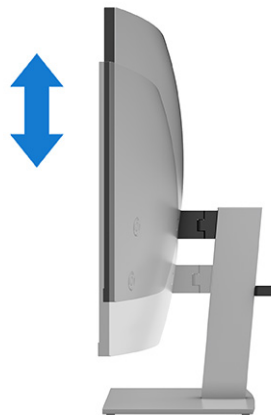

3. Swivel the monitor head to the left or right for the best viewing angle.

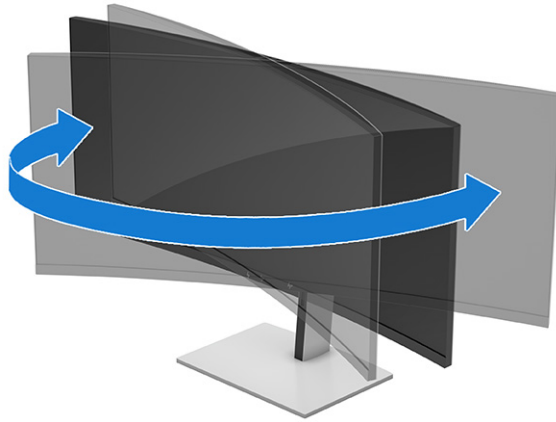

## Installing a security cable

As a security measure, you can secure the monitor to a fixed object with an optional security cable available from HP. Use the key that came with the optional security cable to attach and remove the lock.

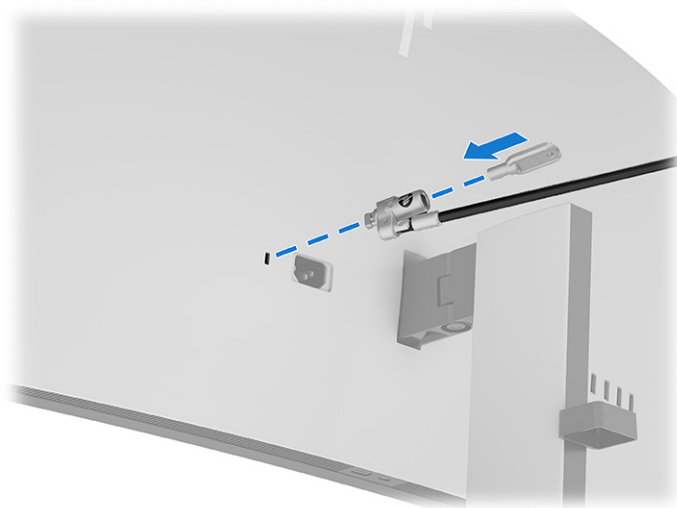

## Turning on the monitor

This section provides important information about preventing damage to your monitor, startup indicators, and troubleshooting information.

 **IMPORTANT:** Burn-in image damage might occur on monitors that display the same static image on the screen for 12 or more hours. To avoid burn-in image damage, you should always activate a screen saver application or turn off the monitor when it will not be in use for a prolonged period of time. Image retention is a condition that might occur on all LCD screens. Burn-in damage on the monitor is not covered under the HP warranty.

Press the power button on the monitor to turn it on.



---

 **NOTE:** If pressing the power button has no effect, the Power Button Lockout feature might be enabled. To disable this feature, press and hold the monitor power button for 10 seconds.

---

When you first turn on your monitor, a monitor status message is displayed for 5 seconds. The message shows which input is the current active signal, the status of the auto-switch source setting (On or Off; default setting is On), the current preset display resolution, and the recommended preset display resolution.

Another message then appears to ask if you want to keep the monitor in power-saving mode or switch to performance mode. You can choose which setting you prefer.

The monitor automatically scans the signal inputs for an active input and uses that input for the display.

## HP watermark and image retention policy

Some monitors are designed with In-Plane Switching (IPS) display technology, which provides ultrawide viewing angles and advanced image quality. Though suitable for many applications, this panel technology is not suitable for static, stationary, or fixed images for long periods of time, unless you use screen savers.

Applications with static images can include camera surveillance, video games, marketing logos, and templates. Static images can cause image retention damage that could look like stains or watermarks on the monitor's screen.

Image retention damage on monitors that are in use 24 hours per day is not covered under the HP warranty. To avoid image retention damage, always turn off the monitor when it is not in use, or use the power management setting, if supported on your computer, to turn off the monitor when the computer is idle.

## Connecting an HP notebook or desktop

You can attach a computer, notebook, gaming console, or similar device to the monitor with a single USB Type-C Thunderbolt connection (port 1). This connection provides network, data, video, and power delivery when you connect the device.

---

 **NOTE:** Be sure that the network cable is connected from the network source jack to the monitor's network jack for a network connection through the USB Type-C Thunderbolt connection (port 1). The performance of the monitor might depend on the host PC.

The host computer must be able to support DisplayPort Alt Mode (video, charging, and USB) over the USB Type-C Thunderbolt connection (port 1) and must also be compatible with USB Type-C ports.

---

To connect a computer, connect one end of a USB Type-C cable to the USB Type-C Thunderbolt connection (port 1) on the rear of the monitor and the other end to the USB Type-C port on the computer. This USB Type-C cable provides single-cable connectivity for high-speed data, audio and video, and power delivery.

---

 **NOTE:** The monitor delivers up to 100 W of power over the USB Type-C Thunderbolt connection (port 1). When connecting the host computer via the USB Type-C Thunderbolt connection (port 1), DC power out does not need to be connected. Do not connect two power sources (DC power out and USB Type-C Thunderbolt connection (port 1) to the host computer.

---

## USB Type-C Thunderbolt mode

When a Thunderbolt cable or a USB Type-C cable is connected to the computer and Alt mode is detected, the monitor switches to the USB Type-C Thunderbolt mode and the following features are activated.

- PXE boot
- Out-of-band MAC address passthrough: Your computer might support MAC Address Passthrough from the on, off, sleep, or hibernation states.

The MAC Address Passthrough is supported for UEFI PXE boot.

- Out-of-band Wake on LAN (WOL): Your computer might support WOL from the off, sleep, or hibernation states. (Performance mode only)

WLAN-LAN switching is supported only on select computers running the Windows® 11 or Windows 10 operating systems.

- Single power on: If the monitor is connected to the computer via the USB Type-C Thunderbolt or USB Type-C input port and you switch the monitor to Performance mode, you can turn the computer on or off using the power button on the monitor.

---

 **NOTE:** You must enable the Power Button (select products only) feature from the Power setting in the OSD menu.

---

---

## 3 Using the monitor

This chapter describes how to use your monitor and its features, including software and utilities, the OSD menu, the function buttons, power modes, and Windows Hello.

### Downloading HP Display Center

You can download and install the HP Display Center software from the Microsoft store.

1. Select the Microsoft Store app on your desktop or type `Microsoft Store` in the taskbar search box.
2. Type `HP Display Center` in the **Microsoft Store** search box.
3. Follow the on-screen instructions.

The tool downloads to the selected location.

### Downloading software and utilities

You can download and install these files from HP Support.

- INF (Information) file
- ICM (Image Color Matching) file

To download the files:

1. Go to <http://www.hp.com/support>.
2. Select **Software and Drivers**.
3. Select your product type.
4. Enter your HP monitor model in the search field and follow the on-screen instructions. The `.inf` and `.icm` files are included in the SoftPkg.

### The Information (INF) file

The INF file defines monitor resources used by Windows operating systems to ensure monitor compatibility with the computer's graphics adapter.

This monitor is Plug and Play compatible, and the monitor will work correctly without installing the INF file. Monitor Plug and Play compatibility requires that the computer's graphics card is VESA DDC2 compliant and that the monitor connects directly to the graphics card. Plug and Play does not work through separate BNC-type connectors or through distribution buffers, boxes, or both.

## The Image Color Matching (ICM) file

The ICM files are data files that are used in conjunction with graphics programs to provide consistent color matching from monitor screen to printer, or from scanner to monitor screen. These files are activated from within graphics programs that support this feature.

 **NOTE:** The ICM color profile is written in accordance with the International Color Consortium (ICC) Profile Format specification.

## Enabling AMD FreeSync Premium compatibility (select products only)

The AMD® FreeSync™ technology eliminates screen tearing and minimizes display stutter and input lag by locking the refresh rate to the frame rate of the graphics card.

 **NOTE:** The AMD FreeSync Premium default setting is **ON**.

 **NOTE:** For better FreeSync performance, you must enable the FreeSync function from the Power Performance mode.

1. Press the center of the Joypad to open the OSD menu.
2. Select **Image**.
3. Select **AdaptiveSync**, and then select **ON**.

 **NOTE:** The camera model supports AMD FreeSync Premium at DisplayPort, USB Type-C, and Thunderbolt 4 (shown as **AdaptiveSync** in the OSD menu).

## Using the OSD menu

You can adjust your HP monitor to suit your preferences. Use the OSD menu to customize the viewing features of your monitor.

To access and make adjustments in the OSD, use the Joypad on the monitor's rear panel. See [Rear components on page 6](#).

1. If the monitor is not already on, press the power button to turn on the monitor.
2. Press the center of the Joypad.
3. Press the function buttons up, down, left, or right to navigate menu choices. Press the center of the Joypad to make a selection.

The following table lists possible menu selections in the OSD main menu. It includes descriptions for each setting and its impacts on your monitor's appearance or performance.

**Table 3-1** OSD menu options and descriptions for using a button or a controller (camera model only)

Main menu	Description
Image	Adjusts the screen image.
Color	Selects and adjusts the screen color.
Split screen	Selects and adjusts PiP or PbP settings.

**Table 3-1** OSD menu options and descriptions for using a button or a controller (camera model only) (continued)

Main menu	Description
Input	Selects the video input signal (DisplayPort, HDMI, USB-C, USB-C Thunderbolt video).
Audio	Selects and adjusts audio settings.
Webcam	Selects and adjusts webcam settings.
Power	Adjusts the power settings.
Menu	Adjusts the OSD menu and function button controls, and selects the language used to display the OSD menu (the factory default is English).
Management	Adjusts information, factory reset, DDC/CI support, DSC support, Ethernet, USB hub, presence detection, and accessibility settings.

**Table 3-2** OSD menu options and descriptions for using a button or a controller (non-camera models only)

Main menu	Description
Image	Adjusts the screen image.
Color	Selects and adjusts the screen color.
Split screen	Selects and adjusts PiP or PbP settings.
Input	Selects the video input signal (DisplayPort, HDMI, USB-C, USB-C Thunderbolt video).
Audio	Selects and adjusts audio settings.
Power	Adjusts the power settings.
Menu	Adjusts the OSD menu and function button controls, and selects the language used to display the OSD menu (the factory default is English).
Management	Adjusts factory reset, DDC/CI support, DSC support, Ethernet, USB hub, and accessibility settings.
Information	Provides information about the monitor such as optimal display mode, power mode, and serial number.

## Using the Joypad buttons

The Joypad menu options offer useful actions, and you can customize all of the buttons except for the menu button (middle button).



**NOTE:** The actions of the Joypad menu options vary among monitor models.

For information about changing the function of the Joypad menu options, see [Reassigning the OSD menu options on page 27](#).





**Table 3-3** Menu options and functions

Option	Icon	Description
Menu		Opens the OSD main menu, selects a menu item from the OSD, or closes the OSD menu.
Next		Switches the monitor's input source to the next active input.
Color		Opens the <b>Color</b> menu where you can select a preset view mode.
Volume		Opens the Volume hot key menu.
Split screen		Turns the split screen option on or off.

**NOTE:** This option turns on the PiP or PbP.

## Reassigning the OSD menu options

Except for the **Menu** option, you can change the action associated with an option from its default action to a menu option you use more frequently.

To reassign the function buttons:

1. Press the **Menu** option to open the OSD menu.
2. Select **Menu**, select **Assign Buttons**, and then select one of the available options for the button that you want to assign.

## Display mode status

When you turn on the monitor, the status message shows the display mode. The display mode is also displayed when you change the video input.

## Changing the Power Mode setting

This section describes how to activate Performance mode. Certain features on your monitor might require Performance mode to be active.

When in sleep mode, to comply with international power standards, the monitor default setting is Power Saver mode. If your monitor supports Performance mode and you need to keep the USB ports enabled when the monitor is in Auto-Sleep Mode, change the Power Mode setting from Power Saver to Performance.

---

 **NOTE:** The Auto-Sleep mode default is ON in Power Saver mode.

 **NOTE:** If you are connecting a computer that is not battery powered, you must change the Power Mode setting to Performance mode.

---

To change the power mode setting:

1. Press the **Menu** button to open the OSD menu.
2. Select **Power**, select **Power Mode**, and then select **Performance**.
3. Select **Back** and close the OSD.

## Using Auto-Sleep Mode

Your monitor has an energy-saving feature called Auto-Sleep Mode, which is a reduced power state. This section describes how to activate or adjust Auto-Sleep Mode on your monitor.

When Auto-Sleep Mode is enabled, which it is by default, the monitor enters a reduced power state when the computer signals low-power mode, which it does by the absence of either a horizontal or vertical sync signal.

Upon entering this reduced power state (Auto-Sleep mode), the monitor screen is blanked, the backlight turns off, and the power light turns amber. The monitor draws less than 0.5 W of power when in this reduced power state. The monitor wakes from Auto-Sleep mode when the computer sends an active signal to the monitor (for example, when you activate the mouse or keyboard).

To disable Auto-Sleep Mode in the OSD:

1. Press the **Menu** button to open the OSD, or press the center of the Joypad to open the OSD.
2. In the OSD, select **Power**.
3. Select **Auto-Sleep Mode**, and then select **Off**.

## Using PiP and PbP

The monitor supports both Picture-in-Picture (PiP), where one source is overlaid on another, and Picture-by-Picture (PbP), where one source is positioned adjacent to another either horizontally (for landscape orientation) or vertically (for portrait orientation). Two full HD (FHD) images can be displayed in the PiP mode.

To use PiP or PbP:

1. Connect a secondary input source to the monitor.

2. Press the center of the OSD controller on the rear of the monitor to open the OSD.
3. In the OSD, select **Split Screen** and then select **PIP (Picture-in-Picture)** or **PbP (Picture-by-Picture)**.  
The monitor scans the secondary inputs for a valid signal input and uses that input for the PiP or PbP picture.
4. To change the PiP or PbP input, select **PIP** in the OSD, and then select **Assign Inputs**.
5. To change the size of the PiP, select **PIP Size** in the OSD, and then select the size that you want.
6. To adjust the position of the PiP, select **PIP Position** in the OSD, and then select the position that you want.

## Using the camera

To unlock the camera, gently press down until it clicks (1). The camera rises up to the uppermost position (2).



---

 **NOTE:** If a camera firmware update is required, unlock the camera before updating the firmware.

---

You can use the camera on the monitor to sign into Windows by using Windows Hello facial recognition, maintain conversation security, and video conferencing.

---

 **NOTE:** For video conferencing, connect the computer to the monitor, and then select **HP Display 5MP AI HDR Camera** from the video conferencing interface.

---

When the camera is closed, the microphone on the camera is disabled.

When the camera is not in use, you can close the camera by pressing down on it until it clicks into the closed position.

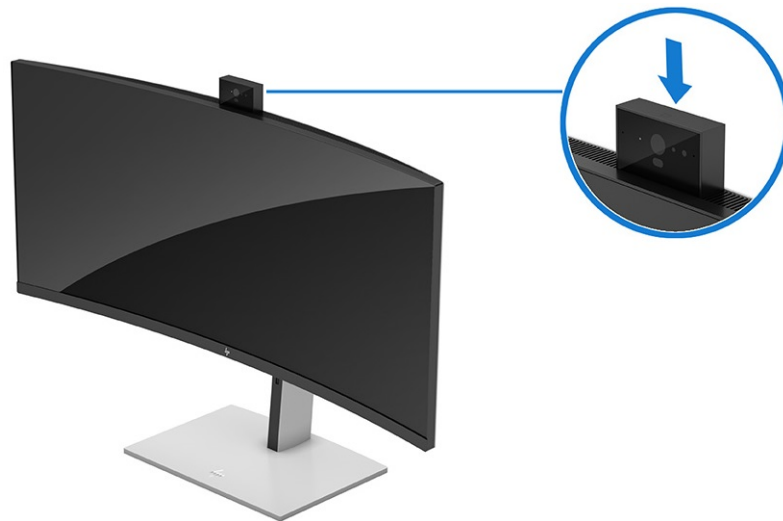

The camera includes these features:

**Table 3-4** Camera features

Option	Description
Image resolution	The resolution is 2560 × 1440 30 fps, 2688 × 1944 30 fps, or 1920 × 1080 60 fps.
Auto-framing	The auto-framing option automatically adjusts the frame keep you in the center of the frame.  You can enable or disable this function from the OSD menu in <b>Webcam &gt; Webcam Auto-Framing</b> .
High Dynamic Range (HDR) support	The HDR option offers a high-quality light and shadow detail in the image in extreme lighting environments.  You can enable or disable this function from the OSD menu in <b>Webcam &gt; Webcam HDR</b> .
Background Blur support	The background is blurred to ensure privacy.  You can enable this function from the OSD menu in <b>Webcam &gt; Webcam Background Blur</b> .

 **NOTE:** You can also enable additional features from HP Display Center.

 **NOTE:** Full HD (1920 × 1080) supports only 30 fps when you enable the HDR or Background Blur function.

## Setting up Windows Hello facial recognition

In select products, you can use Windows Hello facial recognition to gain quick, secure access to your computer. You can establish facial recognition by using either the camera on your computer or the camera on your monitor.

 **NOTE:** Windows Hello is supported on the Windows 10 operating system and above.

### Using the computer camera for Windows Hello

Follow these steps to set up Windows Hello facial recognition on a device with a Windows Hello camera.

1. Download the HP Windows Hello software driver from <http://support.hp.com/us-en/drivers/products>.
2. Connect the monitor to the computer and turn on the computer and monitor.
3. Right-click the Windows desktop and select **Display settings**.
4. Select the monitor and scroll down to the **Multiple displays** section.
5. From the drop-down menu, select **Extend desktop to this display**.
6. Select the **Make this my main display** check box.
7. Select the **Start** button, select **Settings**, select **Accounts**, and then select **Sign-in options**.
8. Under **Windows Hello**, select **Set up** under **Face Recognition**.
9. Under **Welcome to Windows Hello**, select **Get Started**, and then follow the on-screen instructions to enroll your facial ID and set up a personal identification number (PIN).

You can now use the infrared (IR) camera on the monitor to log in when using Windows Hello.

## Using the monitor camera for Windows Hello

Even if your computer does not have a Windows Hello camera, you can still set up Windows Hello facial recognition using the IR camera on your monitor.

1. Select the **Start** button, select **Settings**, select **Accounts**, and then select **Sign-in options**.
2. Under **Windows Hello**, select **Set up** under **Face Recognition**.
3. Under **Welcome to Windows Hello**, select **Get Started**, and then follow the on-screen instructions to enroll your facial ID and set up a PIN.

You can now use the IR camera on the monitor to log in when using Windows Hello.

## Setting up Auto Lock and Awake

Auto Lock and Awake monitors your presence in front of the computer to save power and add security. When you step away from the computer, the proximity sensor puts the computer into the Sleep state. When you return to the computer, your computer recognizes you and wakes the computer automatically. Auto Lock and Awake is turned on by default.

---

 **NOTE:** If you also want to set up facial recognition log-in for Auto Lock and Awake, see [Setting up Windows Hello facial recognition on page 30](#). These features are only supported on the Windows 11 operating system.

 **NOTE:** You can also enable Auto Lock and Awake from the OSD menu. Go to **Management > Presence Detection**.

---

To access Auto Lock and Awake on your monitor:

1. Select the **Start** button, and select **Settings**. Select **System**, and then select **Power & battery**.
2. Under **Power & battery**, select **Screen and sleep**.
3. Select one or both from the following choices:
  - Select **Turn off my screen when I leave** to turn off your screen when you leave the computer.

- Select **Wake up my device when I approach** to wake your computer when you approach it.
4. For more settings, select **More options** in this screen, and then select from the following choices:
- Select **Consider me gone when I'm this far away** to set the distance at which the user-proximity sensor considers you gone.
  - Select **Then turn off my screen after this amount of time** to determine how much time to wait before your screen turns off after you leave your computer.
  - Select **Wake my device when I'm this close** to determine how close you need to be for your computer to wake when you approach it.

You can use the IR camera on the monitor to log in when using Windows Hello.



---

**NOTE:** Some devices might have more than one user-proximity sensor. You can select which one you want to use. When a monitor is attached to a notebook that also has a user-proximity sensor, the operating system automatically selects the monitor's user-proximity sensor.

---

## Ambient light sensor

Select monitors include an ambient light sensor (ALS) that adjusts the brightness based on the ambient lighting conditions in your environment. You can turn the ambient light sensor on or off in OSD under the **Image** menu or from HP Display Center.



---

**NOTE:** If you manually adjust the brightness monitor setting, the ambient light sensor function automatically turns off.

---

When ALS is on, Dynamic Contrast is turned off and disabled. You cannot turn Dynamic Contrast on unless you manually turn off ALS. When the ambient light sensor turns off, you must use the manual brightness controls to adjust brightness. See [Camera components \(camera model only\) on page 5](#).

---

## Multistreaming over USB Type-C Thunderbolt or DisplayPort ports

If you are using the USB Type-C Thunderbolt port 1, USB Type-C port 2, or the DisplayPort as the primary video input source, you can multistream to other DisplayPort monitors that are connected in a daisy-chain configuration.

The number of monitors you can connect through DisplayPort multistreaming depends on a number of factors, including the resolutions and scan rates used for each monitor and the capabilities of your GPU or embedded graphics system. If you have purchased a new graphics card for your computer, check the manual that came with your graphics card for further information about its capabilities.

For the 4K model, you can also connect up to two 4K monitors in this configuration if the graphics card in your computer supports this configuration.

1. Be sure that the USB Thunderbolt port 1, USB Type-C port 2, or Display Port is the primary video input.

2. Add a second monitor by connecting a Thunderbolt or DisplayPort cable between the Thunderbolt OUT or DisplayPort OUT port on the primary monitor, and the Thunderbolt IN or DisplayPort IN port on a secondary monitor.

 **NOTE:** The daisy-chained monitors must have Thunderbolt IN and OUT ports or DisplayPort IN and OUT ports. The last monitor in the chain needs only a Thunderbolt IN video port, or DisplayPort IN video port.

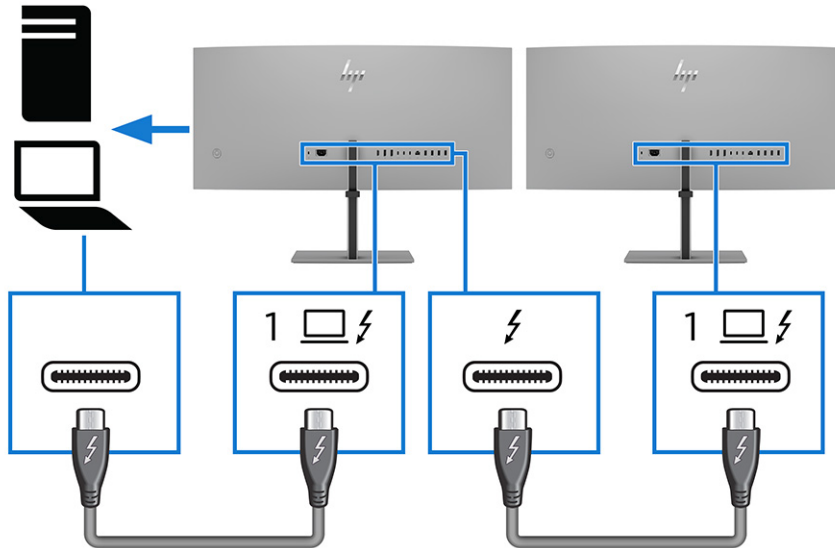

 **NOTE:** The daisy-chained monitors need to have DisplayPort IN and OUT video ports. The last monitor in the chain needs only a DisplayPort IN video port.

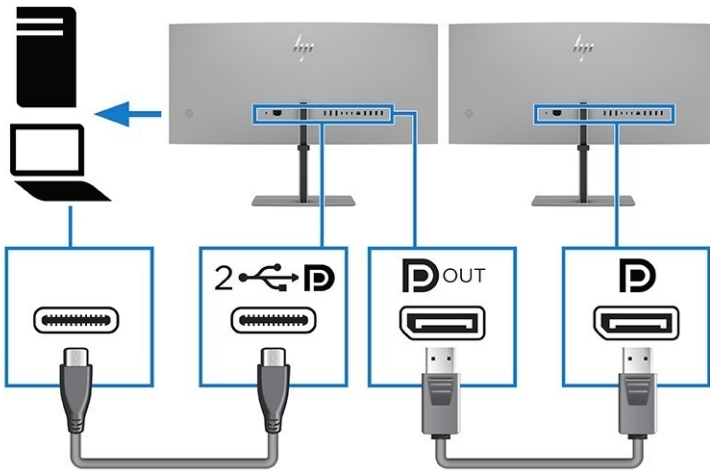
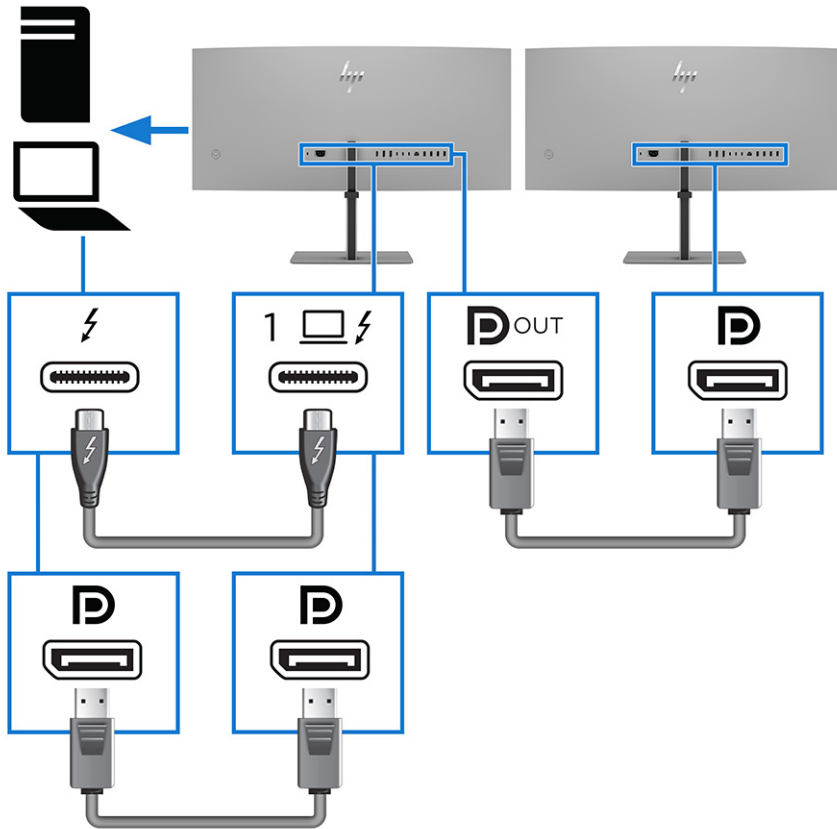

3. Set a connected monitor to display the same image as the primary monitor or a different image.

## Using the split-screen function buttons

The split-screen option offers useful actions that you can use while in split-screen mode.

For information about changing the function of the menu options, see [Reassigning the OSD menu options on page 27](#).

 **NOTE:** When you enable PbP or PiP, the DP MST (Daisy Chain) function is disabled.

1. When the split-screen option is on and **PbP** is selected, the OSD menu is displayed.



2. Select **L** to switch the monitor to full screen for the left input.

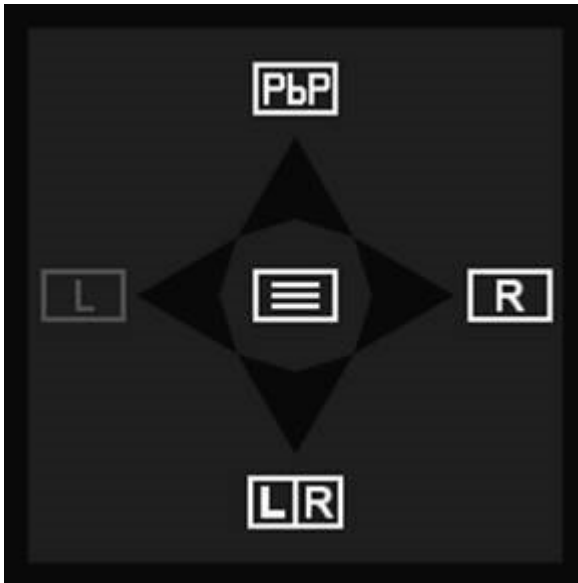

3. Select **R** to switch the monitor to full screen for the right input.

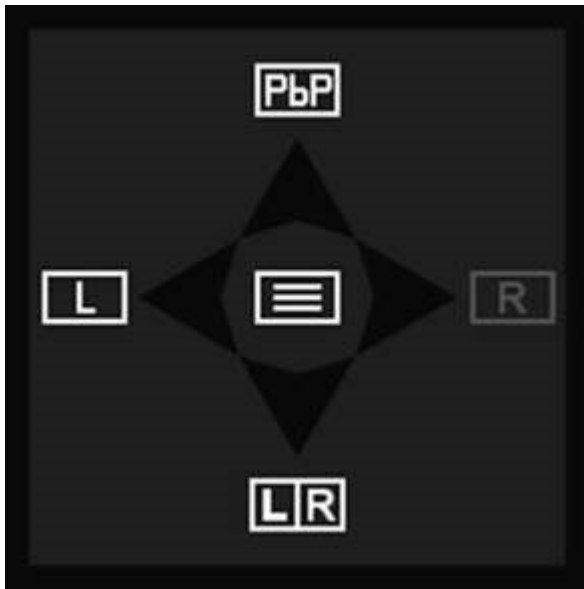

4. Select **LR** to return to split-screen mode. You can also select **PbP** to turn off split screen mode, and then return to the default option or the last changed or saved button menu.

## HP Device Bridge

HP Device Bridge allows two host computers to connect to a single monitor and enables a single keyboard and mouse to control both host computers by switching from one computer to the other. The software also allows you to move files and data from one host computer to the other.

HP Device Bridge is available for the following platforms and must be installed and active on both host computers for the software to work properly:

- Windows
- macOS®

Keep these considerations in mind when using HP Device Bridge:

- VM simulation systems are not supported.
- If one computer has abnormal HP Device Bridge operation caused by entering sleep, suspend, or restart mode, unplug both upstream ports, restart the software on both computers, and then plug in both upstream ports.
- Device Bridge works only when the monitor is set to the USB 3.0 or USB 3.2 option for the **USB-C Configuration** setting.

## Connect the cables

For best results, HP recommends connecting both host computers to the monitor using the USB Type-C connections.

If there is no USB Type-C connection available, HDMI or DisplayPort connections can be used for the video input, and an additional USB Type-C-to-USB Type-A data cable needs to be connected to enable full functionality.

 **NOTE:** When connecting using HDMI or DisplayPort connectors, the USB hub is enabled only if the monitor is also connected to the computer using a USB Type-C cable, or USB Type-C-to-USB Type-A cable.

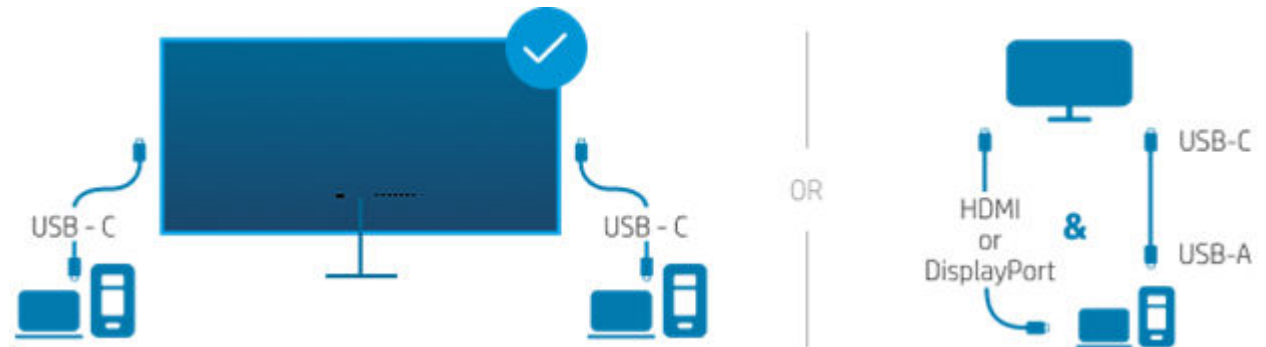

## Download HP Device Bridge

You must download and install HP Device Bridge on both host computers.

 **NOTE:** If HP Device Bridge is not installed on both of the host computers, you will not be able to move files or cut-and-paste from one computer to the other.

- Choose your operating system.
  - Windows
    - a. Open HP Display Center, select the **DEVICE BRIDGE** tab, and then select **Install Now**.

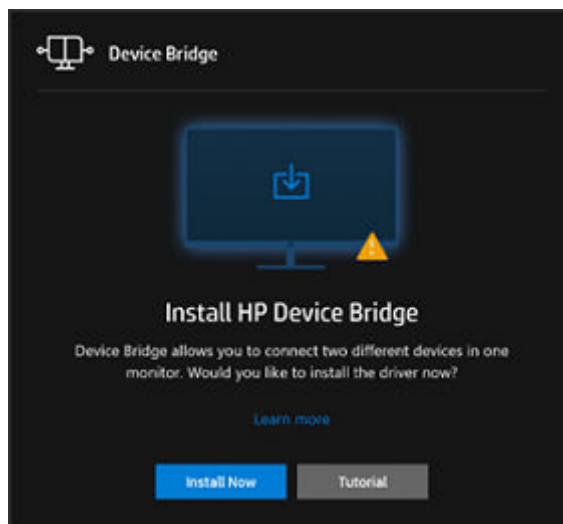

- macOS
  - b. Go to [HP Customer Support - Software and Driver Downloads](#), follow the on-screen instructions to find your product, and then download and install **Device Bridge 2.0** from the Software-Solutions section.

- Go to [HP Customer Support - Software and Driver Downloads](http://www.hp.com/support), follow the on-screen instructions to find your product, select **Choose a different OS**, select **macOS** and the version, and then download and install **Device Bridge 2.0** from the Software-Solutions section.

## Install HP Device Bridge

Use these procedures to install HP Device Bridge for Windows or macOS.

### Windows

1. Go to the HP Customer Support website: <http://www.hp.com/support>.
2. Select **Software and Drivers**, and select **Other**.
3. Enter your monitor model name in the product search box, and select **Submit**.
4. Select **Driver-Display / Monitor**.
5. Download and install the Device Bridge software.
6. Double-click `HPDeviceBridge_ForWin.exe` to start the installation.

### macOS

1. Go to the HP Customer Support website: <http://www.hp.com/support>.
2. Select **Software and Drivers**, and select **Other**.
3. Enter your monitor model name in the product search box, and select **Submit**.
4. Select **Choose a different OS**, select **macOS**, and then specify the version.
5. Select **Driver-Display / Monitor**.
6. Download and install the Device Bridge software.



**NOTE:** HP Device Bridge runs in the background. It must be active to enable HP Device Bridge functions.

## Enable settings for the split screen

Be sure to configure the following settings.

For best performance, in the on-screen display (OSD) settings, be sure that the **Split Screen** setting for each monitor is set to **Device Bridge**, and that **Device Bridge Data Transfer** is enabled.

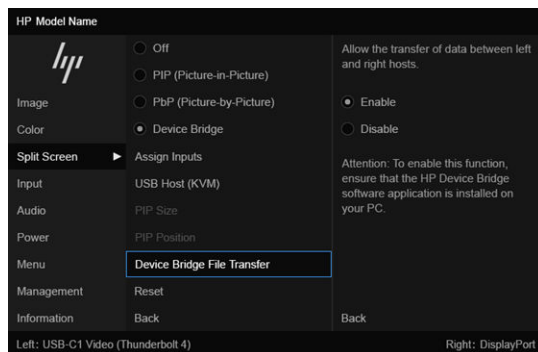

Under **Input**, be sure that the **USB-C Configuration** setting is set to **USB-C Video + USB 3.2** to help ensure that bandwidth is available for data transfer.

 **NOTE:** The resolution depends on your monitor.

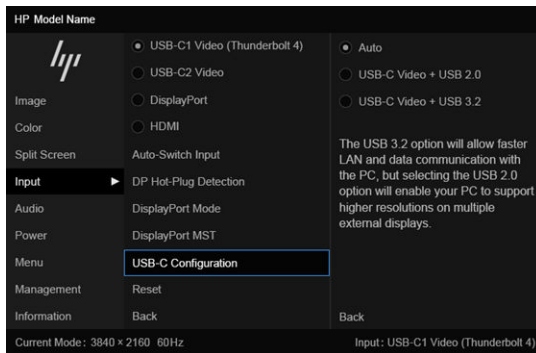

## Using HP Device Bridge

HP Device Bridge allows two host computers to connect to a single monitor and transfer files and data between computers using one common keyboard and mouse. HP Device Bridge must be installed on both host computers for the software to function properly.

 **NOTE:** Device Bridge works only when the monitor is set to the USB 3.0 or USB 3.2 option for the **USB-C Configuration** setting.

If either of the host computers is disconnected from the monitor:

- The remaining connected host computer automatically shows on the monitor in full-screen mode.
- The USB upstream connection switches to the remaining connected host computer to enable the USB hub and USB devices.
- The remaining connected host computer can receive up to 100 W or 65 W of power.

When the disconnected host computer is reconnected:

- HP Device Bridge automatically changes the monitor screen to PbP mode.
- The USB upstream connection switches to the host computer that is connected to the first USB Type-C video port to enable the USB hub and USB devices.
- Power delivery to each of the two host computers returns to the original shared levels.

## Transferring files and data

After HP Device Bridge is installed and active on both host computers, you can move files and data back and forth between host computers. The software enables a single keyboard and mouse to control both host computers by switching from one computer to the other.

Follow this procedure to use the drag-and-drop method:

1. Select the file that you want to transfer.
2. Drag the file from one host computer to the other and drop it in the selected location.

Follow this procedure to use the copy-and-paste or cut-and-paste method:

1. Right-click the file to be transferred, and then select **Copy** or **Cut**, or highlight the data to be copied.
2. Right-click the paste location, and then select **Paste**. The received files are placed in the `/tmp` directory.



---

**NOTE:** HP Device Bridge cannot be closed while transferring files.

---

## Stopping HP Device Bridge (Windows)

Use this procedure to stop using HP Device Bridge with Windows.

1. Right-click the **HP Device Bridge** icon on the taskbar.
2. Select **Exit**.

## Stopping HP Device Bridge (macOS)

Use this procedure to stop using HP Device Bridge with macOS.

1. Select the HP Device Bridge icon at the top-right corner of your screen.
2. Select **Exit**.

## Connecting a second computer to the monitor using the KVM function

The keyboard, video, mouse (KVM) function provides the capability to connect two computers to one monitor with quick monitor access to either computer. It enables both monitors to be controlled using one keyboard and one mouse.

To enable video input from a second computer, connect either a DisplayPort cable or an HDMI cable to the appropriate connector on the rear of the monitor.

For example, connect one end of a DisplayPort cable to a DisplayPort connector on the rear of the monitor, and the other end to a DisplayPort connector on the second computer. If the second computer has only an HDMI port, connect one end of the HDMI cable to an HDMI port on the rear of the monitor, and the other end to an HDMI port on the second computer.

To enable the USB connection to the second computer, connect a USB Type-C to USB Type-A cable to the USB Type-C port (2) on the monitor.

When the USB Type-C Thunderbolt input port (1) is connected and active, the monitor automatically switches to the USB Type-C Thunderbolt input for both video and USB data. The USB Type-C Auto Switch is enabled.

When the USB Type-C Thunderbolt input is disconnected and the second computer is active, the monitor automatically switches back to the active input (DisplayPort or HDMI).

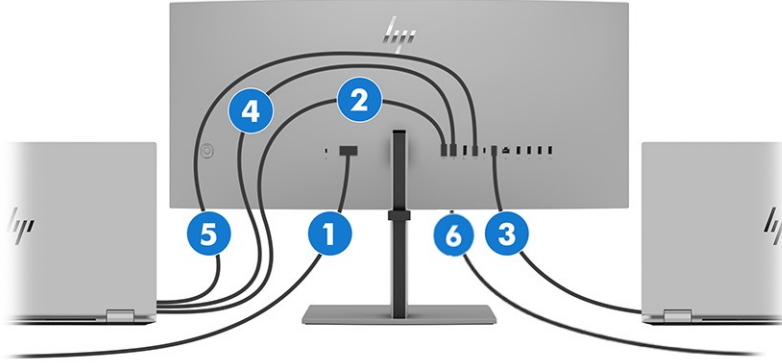

**Table 3-5** Connecting a second monitor

Components		Description
(1)	Power connector	Connects your monitor to a power outlet.
(2)	HDMI port	When the second computer is active (PC 2), the monitor switches to the active input (HDMI or DisplayPort).
(3)	Thunderbolt port (USB Type-C port 1)	Multiple function support includes charging, USB, and display functions.
(4)	DisplayPort connector	When the second computer is active (PC 2), the monitor switches to the active input (HDMI or DisplayPort).
(5)	USB Type-C port 2	USB port connects to PC 2.
(6)	USB Type-A port	Connect a keyboard to this dedicated port located on the bottom of the monitor for KVM functionality. See <a href="#">Rear components on page 6</a> .

## Toggle in KVM Mode

With two computers connected to one monitor and the KVM mode option selected, you can toggle back and forth from one computer to the other by pressing the left **ctrl** key twice on the keyboard.

**NOTE:** Be sure that your keyboard is connected to the USB Type-A port on the bottom of the monitor. See [Rear components on page 6](#).

## Connection priorities in KVM mode

When two monitors are in KVM mode, connection priorities are assigned.

The following types of KVM mode connections are available:

- Thunderbolt USB Type-C port (1) uses a Thunderbolt or USB Type-C cable only.
- USB Type-C port (2) uses a USB Type-C to A cable only.

- Bind mode uses the current video input port even if the auto-switching USB host is disabled. If the first computer is disconnected, the KVM mode setting switches to the second computer, provided it is turned on.

In PiP or PbP mode, the KVM function offers primary input and secondary input. Each input can be selected when PiP or PbP mode is enabled under OSD. The KVM function defaults to the primary Thunderbolt USB Type-C port (1) input, which offers both video and data. You can select a USB Type-C port (2) binding set with the DisplayPort or HDMI port.

If both computers are powered on and connected, the computer with the primary input connection has priority over the other computer in PiP or PbP mode. If the primary input is disconnected and other input port is active, the monitor switches to the active input, and the second binding set is the USB input.

## Using Picture-by-picture (PbP)

The monitor supports Picture-by-picture (PbP), where one source is positioned adjacent to another. The monitor default setting for PbP is **On**. The **Assign Inputs** menu (inside the **Split-Screen** menu) is set to **Automatic**.

When PbP is in automatic mode:

- When you select PbP and the monitor has only one active input, the screen is in full-screen, single-input mode. When a second active input is attached, the monitor automatically switches input to split screen PbP mode.

When you remove one of the two active inputs, the monitor switches back to full-screen mode. The OSD button menu also changes along with full-screen vs. split-screen mode.

- To switch the left/right video input location from the default, see the **Assign Inputs** menu located under **Split Screen**, and then select **Swap Left/Right** screen locations, or select **Manual** to force a specific input to each side of the PbP screen.
- The USB Type-C upstream (host) connection is set to **Auto-Switch USB Host** by default. You can manually change this setting along with the added option to bind a specific USB-C host to a specific DisplayPort or HDMI input in the OSD **USB Host** menu located under **Split Screen**.

You can set PbP to **On, Manual** mode in the **Assign Inputs** menu (inside the **Split-Screen** menu). In this mode, you can control which side of the screen each host computer appears on (left or right) and which video source is assigned to each host computer. To change PbP to manual mode:

1. Connect a secondary input source to the monitor.
2. Press one of the OSD buttons to activate the buttons, and then press the **Menu** button to open the OSD.
3. In the OSD, select **Split Screen**, and then select **PbP (Picture-by-Picture)**.

The monitor scans the secondary inputs for a valid signal input and uses that input for the PbP picture.

4. To change the PbP input, select the **Assign Inputs** menu.



**NOTE:** If PbP is set to **Off**, the monitor displays the image from the host computer that is selected as the active video input source in the **Input** OSD dialog. For more information about the OSD, see [Using the OSD menu on page 25](#).

If you decide to change PbP back to the default **On, Automatic** mode:

1. With two host computers connected to the monitor, press one of the OSD buttons on the rear of the monitor to activate the buttons. Then press the [Menu](#) button to open the OSD. For the location of the OSD buttons, see [Rear components on page 6](#).
2. In the OSD, select the **Split-Screen** menu, and then select either **PbP** (Picture-by-Picture) or **Device Bridge**.

The **Assign Inputs** menu becomes active and you can select the **Automatic** option.

The monitor scans the secondary inputs for a valid video input source and uses that source for the PbP image.

## Setting up DTS Virtual:X for Audio

DTS Virtual:X technology delivers virtual height and multichannel virtual surround in addition to bass and dialog enhancement, which creates an immersive audio experience in any room.

You can enable this function in the OSD settings. Go to **Audio > DTS Audio Modes > Enable DTS Virtual:X**. You can adjust settings in each of the following modes:

- Voice
- Music
- Video
- Basic

## 4 Support and troubleshooting

If your monitor is not working as expected, you might be able to resolve the issue by following the instructions in this section.

### Using the self-test function

To help verify the correct operation of this monitor, a series of startup images and messages is displayed. These images and messages function as a self-test. Use the following procedure to start the self-test.

1. Turn off the monitor and disconnect all of the cables except the power cord.
2. Turn on the monitor. An image similar to the one shown here is displayed.



A monitor status message is displayed.

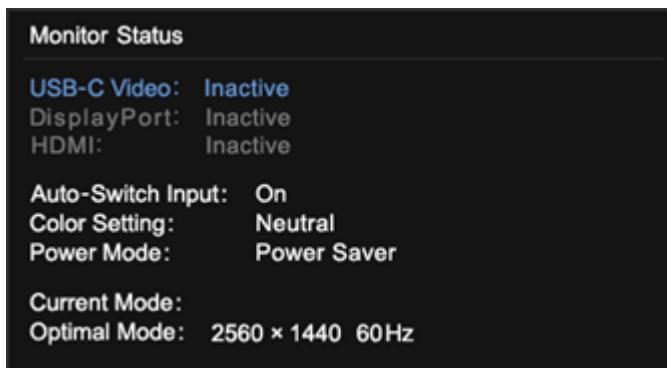

The power-on image and monitor status message indicates that the monitor is working as expected and is looking for a valid video signal.

3. Connect a video source to the monitor and repeat steps 1 through 2. If no external video signal is detected, check the video connection to the host computer.

# Internal test pattern generator

This monitor includes a built-in test pattern generator called **Diagnostic Patterns** to help with diagnosing visual anomalies.

To open **Diagnostic Patterns**:

1. Turn on the monitor.

---

 **NOTE:** Video inputs do not need to be connected.

---

2. In the left column, navigate to **Management**.
3. In the middle column, navigate to **Diagnostic Patterns**.
4. Perform one of these tasks for the options in the right column:
  - Highlight an option to see a preview in the background (behind the on-screen display (OSD) menu).
  - Select an option to close the OSD menu and view the test pattern in full screen. Press any of the menu buttons in the column to exit the full screen pattern and return to the OSD menu.
  - To close the **Diagnostic Patterns** menu, select **Back** at the bottom of the right column or select any of the other options in the middle column.
  - To close the OSD menu, select **Exit** at the bottom of the left column.

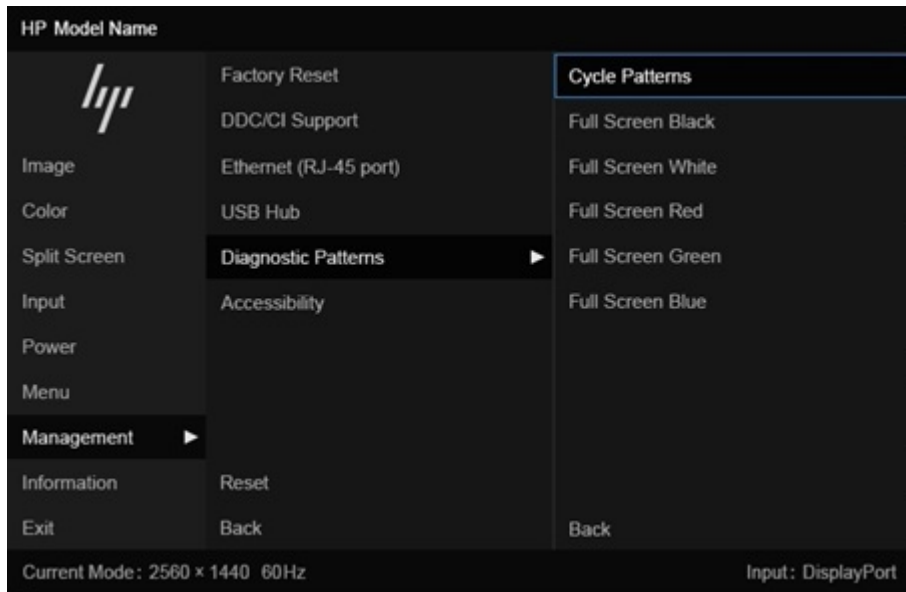

---

 **NOTE:** You can view the diagnostic patterns with or without an active external video signal.

---

# Solving common issues

The following table lists possible issues, the possible cause of each issue, and the recommended solutions.



**NOTE:** Always ensure that the BIOS, device firmware, and monitor firmware are updated to the latest version.

**Table 4-1 Common issues and solutions**

Issues	Possible cause	Solution
Screen is blank or video is blinking.	Power cord is disconnected.	Connect the power cord.
	Monitor is off.	Press the monitor power button.  <b>NOTE:</b> If pressing the power button has no effect, press and hold the power button for 10 seconds to disable the Power Button Lockout feature.
	Video cable is improperly connected.	Connect the video cable properly. For more information, see <a href="#">Connecting the cables on page 13</a> .
	System is in Auto-Sleep Mode.	Press any key on the keyboard or move the mouse to inactivate the screen blanking utility.
	Video card is incompatible.	Perform one of the following tasks: <ul style="list-style-type: none"> <li>• Open the OSD menu and select the <b>Input</b> menu. Set <b>Auto-Switch Input</b> to <b>Off</b> and manually select the input.</li> <li>• Replace the video card or connect the video cable to one of the computer's on-board video sources.</li> </ul>
Image appears blurred, indistinct, or too dark.	Brightness setting is too low.	Open the OSD menu, and select <b>Brightness+</b> to adjust the brightness scale as needed.
"Check Video Cable" is displayed on the screen.	Monitor video cable is disconnected.	Connect the appropriate video signal cable between the computer and monitor. Be sure that the computer power is off while connecting the video cable.
"Input Signal Out of Range" is displayed on screen.	Video resolution rate, refresh rate, or both, are set higher than the monitor supports.	Change the settings to a supported setting. See <a href="#">Preset display resolutions on page 52</a> .
The monitor does not enter into a low-power sleep state.	The monitor's power saving control is disabled.	Open the OSD menu and select <b>Power</b> , select <b>Auto-Sleep Mode</b> , and then set auto-sleep to <b>On</b> .
"OSD Lockout" is displayed.	The monitor's OSD Lockout function is enabled.	Press and hold the <b>Left</b> button for 10 seconds to disable the OSD Lockout function.
"Power Button Lockout" is displayed.	The monitor's Power Button Lockout feature is enabled.	Press and hold the <b>Power</b> button for 10 seconds to unlock the power button function.
Monitor has trouble waking from Sleep mode		DisplayPort inputs: Set the DisplayPort hot-plug detection to <b>Always Active</b> .  Power mode monitors: Set the hot-plug detection to <b>Always Active</b> to switch the monitor to Performance mode.



**Table 4-1** Common issues and solutions (continued)

Issues	Possible cause	Solution
Slow performance from USB		The monitor has a two-lane default for USB-C. On selected products, you can press the Joypad button to open the OSD menu, navigate to the USB Type-C configuration, and then select <b>USB-C Video + USB 3.0</b> for data transfer prioritization.
Lower refresh rate or color bits		Select <b>USB-C Video + USB 2.0</b> for refresh rate/color bits prioritization.
LAN connection drop		Check if the LAN driver version on the host PC is up to date.

## Button lockouts

The button lockout function is available only when the monitor is on, an active signal is displayed, and the OSD menu is closed. Holding down the power button or [Left](#) button for 10 seconds disables that button. You can enable the button again by holding it down for 10 seconds.



---

## 5 Maintaining the monitor

Properly maintained, your monitor can run for many years. These instructions provide steps you can perform to keep your monitor in the best condition.

### Maintenance guidelines

Follow these instructions to enhance the performance and extend the life of the monitor.

- Do not open the monitor cabinet or attempt to service this product yourself. Adjust only those controls that are covered in the operating instructions. If the monitor is not operating properly or has been dropped or damaged, contact an authorized HP dealer, reseller, or service provider.
- Use only a power source and connection appropriate for this monitor, as indicated on the label or back plate of the monitor.
- Be sure that the total ampere rating of the products connected to the outlet does not exceed the current rating of the AC outlet and that the total ampere rating of the products connected to the cord does not exceed the rating of the cord. Look on the power label to determine the ampere rating (AMPS or A) for each device.
- Install the monitor near an outlet that you can easily reach. Disconnect the monitor by grasping the plug firmly and pulling it from the outlet. Never disconnect the monitor by pulling the cord.
- Turn the monitor off when it is not in use, and use a screen saver program. Doing this can substantially increase the life expectancy of the monitor.



**NOTE:** A burned-in image on the monitor is not covered under the HP warranty.

---

- Never block the slots and openings of the cabinet or push objects into them. These openings provide ventilation.
- Do not drop the monitor or place it on an unstable surface.
- Do not allow anything to rest on the power cord. Do not walk on the cord.
- Keep the monitor in a well-ventilated area, away from excessive light, heat, or moisture.

### Cleaning the monitor

Use these instructions to clean your monitor when necessary.

1. Turn off the monitor and unplug the power cord from the AC outlet.
2. Disconnect any external devices.
3. Dust the monitor by wiping the screen and the cabinet with a soft, clean antistatic cloth.



**CAUTION:** Never spray cleaner directly onto the screen. It can run behind the bezel and damage the electronics. Water dripping into the ventilation openings or other points of entry can cause

damage to the monitor. Protect your monitor by always consulting your user guide for cleaning procedures, or go to <http://www.hp.com/support> and search for *How to Clean Your Computer*.

 **IMPORTANT:** Do not use cleaners that contain petroleum-based materials such as benzene, thinner, or any volatile substance to clean the monitor screen or cabinet. These chemicals might damage the monitor.

 **IMPORTANT:** Spray the cleaner onto a cloth and use the damp cloth to gently wipe the screen surface. The cloth should be moist, but not wet. Allow the monitor to air-dry before use.

---

4. After you remove the dirt and debris, you can also clean the surfaces with a disinfectant. The World Health Organization (WHO) recommends cleaning surfaces, followed by disinfection, as a best practice for preventing the spread of viral respiratory illnesses and harmful bacteria. A disinfectant that is within HP's cleaning guidelines is an alcohol solution consisting of 70% isopropyl alcohol and 30% water. This solution is also known as rubbing alcohol and is sold in most stores.

## Shipping the monitor

Keep the original packing box in a storage area. You might need it later if you ship the monitor or move.

# A Technical specifications

This section contains technical specifications for the physical aspects of your monitor, such as the weight and viewing dimensions, as well as required environmental operating conditions and power source ranges.

All specifications represent the typical specifications provided by HP component manufacturers; actual performance can vary either higher or lower.



**NOTE:** For the latest specifications or additional specifications for this product, go to <http://www.hp.com/go/quickspecs/> and search for your specific monitor model to find the model-specific QuickSpecs.

## 86.4 cm (34 in) model specifications (WQHD)

This section provides specifications for your monitor.

**Table A-1** Technical specifications

Specification	Metric	U.S.
<b>Display, wide-screen</b>	<b>86.40 cm</b>	34.00 in
Type	IPS Black	
<b>Viewable image size</b>	<b>86.40 cm diagonal</b>	34.00 in diagonal
<b>Maximum weight (unpacked)</b>	<b>11.40 kg</b>	25.10 lbs
<b>Dimensions (include base)</b>		
Height (highest position)	<b>54.74 cm</b>	21.55 in
Height (lowest position)	<b>39.74 cm</b>	15.65 in
Depth	<b>26.69 cm or 26.99 cm*</b>	10.51 in or 10.63 in*
Width	<b>81.38 cm</b>	32.04 in
<b>Tilt</b>	<b>-5° to 20°</b>	
<b>Swivel</b>	<b>0° ±10° or 0° ±30°*</b>	
<b>Environmental requirements temperature</b>		
Operating temperature	<b>5°C to 35°C</b>	41°F to 95°F
Storage temperature	<b>-40°C to 65°C</b>	-40°F to 149°F
Storage humidity	5% to 95% (noncondensing)	
<b>Power source</b>	100 V AC to 240 V AC, 3.9 A, 50 Hz to 60 Hz	
<b>Input terminal</b>	One HDMI port, one DisplayPort port, one RJ-45 with Manageability, and two USB Type-C Alt Mode DP ports	
<b>Webcam</b>		
Active array size	5 MP	



**Table A-1** Technical specifications (continued)

Specification	Metric	U.S.
RGB field of view	DFOV = 95.6°	
Maximum video frame rate	2688 × 1944 (5 MP) at 30 fps	

\*For additional information, call your local customer service representative for confirmation of your product spec and dimensions.

## 95.3 cm (37.5 in) model specifications (WQHD+)

This section provides specifications for your monitor.

**Table A-2** Technical specifications

Specification	Metric	U.S.
<b>Display, wide-screen</b>	<b>95.30 cm</b>	37.50 in
Type	IPS Black	
<b>Viewable image size</b>	<b>95.30 cm diagonal</b>	37.50 in diagonal
<b>Maximum weight (unpacked)</b>	<b>12.30 kg</b>	27.12 lbs
<b>Dimensions (include base)</b>		
Height (highest position)	<b>58.10 cm</b>	22.87 in
Height (lowest position)	<b>43.10 cm</b>	16.97 in
Depth	<b>26.69 cm or 26.99 cm*</b>	10.51 in or 10.63 in*
Width	<b>89.44 cm</b>	35.21 in
<b>Tilt</b>	<b>-5° to 20°</b>	
<b>Swivel</b>	<b>0° ±10° or 0° ±30**</b>	
<b>Environmental requirements temperature</b>		
Operating temperature	<b>5°C to 35°C</b>	41°F to 95°F
Storage temperature	<b>-40°C to 65°C</b>	-40°F to 149°F
Storage humidity	5% to 95% (noncondensing)	
<b>Power source</b>	100 V AC to 240 V AC, 3.8 A, 50 Hz to 60 Hz	
<b>Input terminal</b>	One HDMI port, one DisplayPort port, one RJ-45 with Manageability, and two USB Type-C Alt Mode DP ports	

\*For additional information, call your local customer service representative for confirmation of your product spec and dimensions.

# Preset display resolutions

The following display resolutions are the most commonly used modes and are set as factory defaults. The monitor automatically recognizes these preset modes, and they will appear properly sized and centered on the screen.

## 86.4 cm (34 in) model (WQHD)

This section provides preset display resolutions and preset timing resolutions.

**Table A-3** Preset display resolutions

Preset	Pixel format	Horz freq (kHz)	Vert freq (Hz)
1	640 × 480	31.469	59.940
2	640 × 480	37.500	75.000
3	720 × 400	31.469	70.087
4	800 × 600	37.879	60.317
5	800 × 600	46.875	75.000
6	1024 × 768	48.363	60.004
7	1024 × 768	60.023	75.029
8	1280 × 720	45.000	60.000
9	1280 × 1024	63.981	60.020
10	1280 × 1024	79.976	75.025
11	1440 × 900	55.469	59.901
12	1600 × 900	60.000	60.000
13	1600 × 1200	75.000	60.000
14	1680 × 1050	65.290	60.020
15	1920 × 1080	67.500	59.954
16	1920 × 1200	74.566	59.885
17	2560 × 1440	88.787	59.951
18	2560 × 1440	182.996	120.000
19	3440 × 1440	43.819	30.000 (HDMI only)
20	3440 × 1440	88.819	60.000
21	3440 × 1440	111.875	75.000
22	3440 × 1440	150.972	100.000
23	3440 × 1440	182.996	120.000 (HDMI excluded)

**Table A-4** Preset timing resolutions

Preset	Pixel format	Horz freq (kHz)	Vert freq (Hz)
1	720 × 480	31.469	59.940



**Table A-4** Preset timing resolutions (continued)

Preset	Pixel format	Horz freq (kHz)	Vert freq (Hz)
2	1280 × 720	45.000	60.000
3	720 × 576	31.250	50.000
4	1280 × 720	37.500	50.000
5	1920 × 1080	67.500	60.000
6	1920 × 1080	56.250	50.000
7	1920 × 1080	112.500	100.000
8	1920 × 1080	135.000	120.000

## 95.3 cm (37.5 in) model (WQHD+)

This section provides preset display resolutions and preset timing resolutions.

**Table A-5** Preset display resolutions

Preset	Pixel format	Horz freq (kHz)	Vert freq (Hz)
1	640 × 480	31.469	59.940
2	720 × 400	31.469	70.087
3	800 × 600	37.879	60.317
4	1024 × 768	48.363	60.004
5	1280 × 720	45.000	60.000
6	1280 × 1024	63.891	60.020
7	1440 × 900	55.469	59.901
8	1600 × 900	60.000	60.000
9	1600 × 1200	75.000	60.000
10	1680 × 1050	48.363	59.994
11	1920 × 1080	65.290	60.000
12	1920 × 1200	74.038	59.950
13	2560 × 1440	88.787	59.951
14	2560 × 1600	98.713	59.972
15	3840 × 1600	98.750	59.994
16	3840 × 1600	48.688	29.998

**Table A-6** Preset timing resolutions

Preset	Pixel format	Horz freq (kHz)	Vert freq (Hz)
1	720 × 480	31.469	59.940
2	1280 × 720	45.000	60.000

**Table A-6** Preset timing resolutions (continued)

Preset	Pixel format	Horz freq (kHz)	Vert freq (Hz)
3	720 × 576	31.250	50.000
4	1280 × 720	37.500	50.000
5	1920 × 1080	56.250	50.000
6	1920 × 1080	67.500	60.000

## Energy saver feature

This monitor supports a reduced power state.

The reduced power state is initiated if the monitor detects the absence of either the horizontal sync signal or the vertical sync signal. Upon detecting the absence of these signals, the monitor screen is blank, the backlight is turned off, and the power light turns amber. In the reduced power state, the monitor uses < 0.5 W of power. There is a brief warm-up period before the monitor returns to its normal operating state.

See the computer manual for instructions on setting the energy saver mode (sometimes called “power management feature”).



**NOTE:** This power saver feature works only when the monitor is connected to a computer that has energy-saver features.

By selecting the settings in the monitor Sleep Timer utility, you can also program the monitor to initiate the reduced power state at a predetermined time. When the monitor Sleep Timer utility initiates the reduced power state, the power light blinks amber.



---

# B Accessibility

HP's goal is to design, produce, and market products, services, and information that everyone everywhere can use, either on a standalone basis or with appropriate third-party assistive technology (AT) devices or applications.

## HP and accessibility

Because HP works to weave diversity, inclusion, and work/life into the fabric of the company, it is reflected in everything HP does. HP strives to create an inclusive environment focused on connecting people to the power of technology throughout the world.

## Finding the technology tools you need

Technology can unleash your human potential. Assistive technology removes barriers and helps you create independence at home, at work, and in the community. Assistive technology helps increase, maintain, and improve the functional capabilities of electronic and information technology.

For more information, see [Finding the best assistive technology on page 56](#).

## The HP commitment

HP is committed to providing products and services that are accessible for people with disabilities. This commitment supports the company's diversity objectives and helps ensure that the benefits of technology are available to all.

The HP accessibility goal is to design, produce, and market products and services that can be effectively used by everyone, including people with disabilities, either on a standalone basis or with appropriate assistive devices.

To achieve that goal, this Accessibility Policy establishes seven key objectives to guide HP actions. All HP managers and employees are expected to support these objectives and their implementation in accordance with their roles and responsibilities:

- Raise the level of awareness of accessibility issues within HP, and provide employees with the training they need to design, produce, market, and deliver accessible products and services.
- Develop accessibility guidelines for products and services, and hold product development groups accountable for implementing these guidelines where competitively, technically, and economically feasible.
- Involve people with disabilities in the development of accessibility guidelines and in the design and testing of products and services.
- Document accessibility features, and make information about HP products and services publicly available in an accessible form.
- Establish relationships with leading assistive technology and solution providers.
- Support internal and external research and development that improves assistive technology relevant to HP products and services.

- Support and contribute to industry standards and guidelines for accessibility.

## International Association of Accessibility Professionals (IAAP)

IAAP is a not-for-profit association focused on advancing the accessibility profession through networking, education, and certification. The objective is to help accessibility professionals develop and advance their careers and to better enable organizations to integrate accessibility into their products and infrastructure.

As a founding member, HP joined to participate with other organizations to advance the field of accessibility. This commitment supports HP's accessibility goal of designing, producing, and marketing products and services that people with disabilities can effectively use.

IAAP will make the profession strong by globally connecting individuals, students, and organizations to learn from one another. If you are interested in learning more, go to <http://www.accessibilityassociation.org> to join the online community, sign up for newsletters, and learn about membership options.

## Finding the best assistive technology

Everyone, including people with disabilities or age-related limitations, should be able to communicate, express themselves, and connect with the world using technology. HP is committed to increasing accessibility awareness within HP and with our customers and partners.

Whether it's large fonts that are easy on the eyes, voice recognition that lets you give your hands a rest, or any other assistive technology to help with your specific situation—a variety of assistive technologies make HP products easier to use. How do you choose?

## Assessing your needs

Technology can unleash your potential. Assistive technology removes barriers and helps you create independence at home, at work, and in the community. Assistive technology (AT) helps increase, maintain, and improve the functional capabilities of electronic and information technology.

You can choose from many AT products. Your AT assessment should allow you to evaluate several products, answer your questions, and facilitate your selection of the best solution for your situation. You will find that professionals qualified to do AT assessments come from many fields, including those licensed or certified in physical therapy, occupational therapy, speech/language pathology, and other areas of expertise. Others, while not certified or licensed, can also provide evaluation information. You will want to ask about the individual's experience, expertise, and fees to determine if they are appropriate for your needs.

## Accessibility for HP products

These links provide information about accessibility features and assistive technology, if applicable and available in your country or region, that are included in various HP products. These resources will help you select the specific assistive technology features and products most appropriate for your situation.

- HP Aging & Accessibility: Go to <http://www.hp.com>, type **Accessibility** in the search box. Select **Office of Aging and Accessibility**.
- HP computers: For Windows products, go to <http://www.hp.com/support>, type **Windows Accessibility Options** in the **Search our knowledge library** search box. Select the appropriate operating system in the results.
- HP Shopping, peripherals for HP products: Go to <http://store.hp.com>, select **Shop**, and then select **Monitors** or **Accessories**.

If you need additional support with the accessibility features on your HP product, see [Contacting support on page 61](#).

Additional links to external partners and suppliers that may provide additional assistance:

- [Microsoft Accessibility information \(Windows and Microsoft Office\)](#)
- [Google Products accessibility information \(Android, Chrome, Google Apps\)](#)

## Monitor accessibility features (select products/regions only)

HP monitors enable you to find and configure display settings directly from your monitor, without needing to use an external device such as a computer, using multiple types of accessibility enhancements.

### Built-in accessibility features

The following accessibility features are built into the monitor.

- Physical buttons or a Joypad that are tactilely discoverable.
- Physical button or Joypad labels that are displayed on-screen.
- On-Screen Display (OSD) menu
  - Menu items, text, and elements meet a 4.5:1 (or greater) contrast ratio.
  - Focus indication is provided.

### Text to Speech

Text to Speech converts text into spoken words. You can enable text to assist you when reading text on the monitor.

If your monitor has built-in speakers, you can request the TTS accessibility device by calling HP Support at (877) 656-7058 Monday through Friday, 6 a.m. to 9 p.m. Mountain Time.



---

**NOTE:** The Text to Speech feature is spoken in English only. Support is in English only.

---

### What is Accessibility Mode?

Accessibility Mode enables you to use audio navigation and to enlarge items on the screen.

When you turn on Accessibility Mode, the following adjustments are made:

- Menu timeout setting is set to the maximum duration of 60 seconds (default is 30 seconds).
- Language is set to English, which is the only language currently supported in Accessibility Mode. When Accessibility Mode is turned off, the previous language is used.
- On FHD monitors, the OSD menu is set to a fixed position in the lower-right quadrant of the screen.
- Menu items, text, and other elements meet a 4.5:1 contrast ratio or greater.
- Text is enlarged to a 4.8 mm or larger font size.

## How do you turn Accessibility Mode on or off?

Turn Accessibility Mode on or off using either physical monitor controls or an OSD menu.

- On a monitor with a Joypad, press and hold the center of the Joypad for four seconds to turn Accessibility Mode on or off.

When Accessibility Mode is turned on using a physical button, an Accessibility Mode is On message is displayed. When Accessibility Mode is turned off using a physical button, an Accessibility Mode is Off message is displayed.

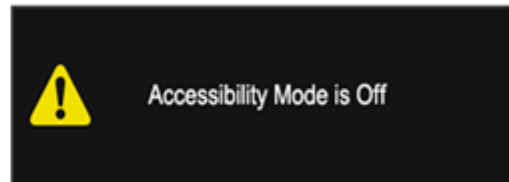
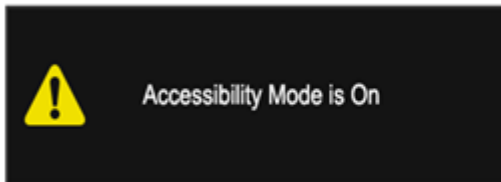

- Using the OSD menu
  - To turn on Accessibility Mode, set the language to English, and then select **Management > Accessibility > On**.
  - To turn off Accessibility Mode, select **Management > Accessibility > Off**.

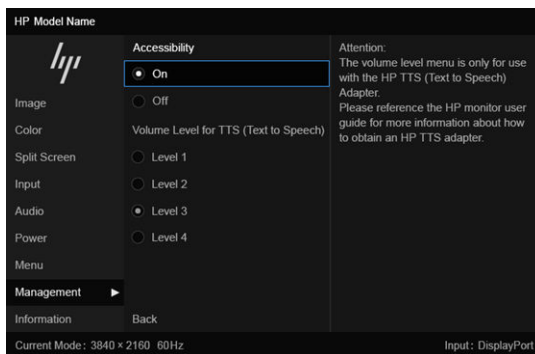

## Standards and legislation

Countries worldwide are enacting regulations to improve access to products and services for persons with disabilities. These regulations are historically applicable to telecommunications products and services, PCs and printers with certain communications and video playback features, their associated user documentation, and their customer support.

### Standards

The US Access Board created Section 508 of the Federal Acquisition Regulation (FAR) standards to address access to information and communication technology (ICT) for people with physical, sensory, or cognitive disabilities.

The standards contain technical criteria specific to various types of technologies, as well as performance-based requirements which focus on functional capabilities of covered products. Specific criteria cover software applications and operating systems, web-based information and applications, computers, telecommunications products, video and multimedia, and self-contained closed products.

## Mandate 376 – EN 301 549

The European Union created the EN 301 549 standard within Mandate 376 as an online toolkit for public procurement of ICT products. The standard specifies the accessibility requirements applicable to ICT products and services, with a description of the test procedures and evaluation methodology for each requirement.

### Web Content Accessibility Guidelines (WCAG)

Web Content Accessibility Guidelines (WCAG) from the W3C's Web Accessibility Initiative (WAI) helps web designers and developers create sites that better meet the needs of people with disabilities or age-related limitations.

WCAG advances accessibility across the full range of web content (text, images, audio, and video) and web applications. WCAG can be precisely tested, is easy to understand and use, and allows web developers flexibility for innovation. WCAG 2.0 has also been approved as [ISO/IEC 40500:2012](#).

WCAG specifically addresses barriers to accessing the web experienced by people with visual, auditory, physical, cognitive, and neurological disabilities, and by older web users with accessibility needs. WCAG 2.0 provides characteristics of accessible content:

- **Perceivable** (for instance, by addressing text alternatives for images, captions for audio, adaptability of presentation, and color contrast)
- **Operable** (by addressing keyboard access, color contrast, timing of input, seizure avoidance, and navigability)
- **Understandable** (by addressing readability, predictability, and input assistance)
- **Robust** (for instance, by addressing compatibility with assistive technologies)

### Legislation and regulations

Accessibility of IT and information has become an area of increasing legislative importance.

The [HP policy landscape](#) website provides information about key legislation, regulations, and standards in the following locations:

- United States
- Canada
- Europe
- Australia

### Useful accessibility resources and links

These organizations, institutions, and resources might be good sources of information about disabilities and age-related limitations.

---

 **NOTE:** This is not an exhaustive list. These organizations are provided for informational purposes only. HP assumes no responsibility for information or contacts you encounter on the internet. Listing on this page does not imply endorsement by HP.

---

## Organizations

These organizations are a few of the many that provide information about disabilities and age-related limitations.

- American Association of People with Disabilities (AAPD)
- The Association of Assistive Technology Act Programs (ATAP)
- Hearing Loss Association of America (HLAA)
- Information Technology Technical Assistance and Training Center (ITTATC)
- Lighthouse International
- National Association of the Deaf
- National Federation of the Blind
- Rehabilitation Engineering & Assistive Technology Society of North America (RESNA)
- Telecommunications for the Deaf and Hard of Hearing, Inc. (TDI)
- W3C Web Accessibility Initiative (WAI)

## Educational institutions

Many educational institutions, including these examples, provide information about disabilities and age-related limitations.

- California State University, Northridge, Center on Disabilities (CSUN)
- University of Wisconsin - Madison, Trace Center
- University of Minnesota computer accommodations program

## Other disability resources

Many resources, including these examples, provide information about disabilities and age-related limitations.

- ADA (Americans with Disabilities Act) Technical Assistance Program
- ILO Global Business and Disability network
- EnableMart
- European Disability Forum
- Job Accommodation Network
- Microsoft Enable

## HP links

These HP-specific links provide information that relates to disabilities and age-related limitations.

[HP comfort and safety guide](#)

[HP public sector sales](#)

# Contacting support

HP offers technical support and assistance with accessibility options for customers with disabilities.



---

**NOTE:** Support is in English only.

---

- Customers who are deaf or hard of hearing who have questions about technical support or accessibility of HP products:
  - Use TRS/VRS/WebCapTel to call (877) 656-7058 Monday through Friday, 6 a.m. to 9 p.m. Mountain Time.
- Customers with other disabilities or age-related limitations who have questions about technical support or accessibility of HP products:
  - Call (888) 259-5707 Monday through Friday, 6 a.m. to 9 p.m. Mountain Time.

---

# Index

- A**
  - accessibility 55, 56, 59, 60
  - accessibility needs
    - assessment 56
  - ambient light sensor 32
  - assistive technology (AT)
    - finding 56
    - purpose 55
  - AT (assistive technology)
    - finding 56
    - purpose 55
- C**
  - calling technical support 3
  - components
    - front 5
    - rear 6
  - connectors
    - DisplayPort 6
    - power 6
  - customer support, accessibility 61
- D**
  - diagnostics 44
  - DisplayPort connector 6
  - DTS Virtual:X for Audio 43
- F**
  - front components 5
- G**
  - getting started 2
  - getting to know your monitor 3
- H**
  - HDMI port 6
  - HP Assistive Policy 55
  - HP Device Bridge 36, 39, 40
  - HP Display Center 24
  - HP resources 3
  - HP support 3
- I**
  - installing HP Device Bridge 38
  - internal diagnostics 45
  - International Association of Accessibility Professionals 56
- K**
  - KVM functionality 40
- L**
  - label 8
- M**
  - menu button 5
- O**
  - OSD button 5
- P**
  - ports
    - HDMI 6
    - USB port with HP Sleep and Charge 8
    - USB Type-C 6
    - USB Type-C with HP Sleep and Charge 7, 8
  - power connector 6
  - product label 8
  - product number 8
- R**
  - rear components 6
  - resources, accessibility 59
- S**
  - safety information 2
  - Section 508 accessibility standards 58
  - self-test 44
  - serial number 8
  - standards and legislation, accessibility 58
  - support 3
- T**
  - technical support 3
  - Text to Speech 57
  - transferring files and data 39
  - troubleshooting 44
- U**
  - USB port with HP Sleep and Charge, identifying 8
  - USB Type-C port 6
  - USB Type-C port with HP Sleep and Charge, identifying 8
  - USB Type-C Thunderbolt port identifying 7
- W**
  - warnings 2

