

Panasonic®

Operating & Installation Instructions

Washing Machine
(Household Use)

Model No.
NA-120VX6
NA-120VG6



Contents

SAFETY PRECAUTIONS	4
Before Using	8
Washing	14
Optional Functions	22
Maintenance	27
Troubleshooting	30
Installation / Others	34

Thank you for purchasing this product.

- Read these instructions carefully for optimum performance and safety before use.
- Keep this manual for future reference.

Contents

SAFETY PRECAUTIONS	■ Safety Precautions	4
--------------------	--------------------------------	---

Before Using	■ Checking Your Washing Machine	8
	■ Before Washing	9
	■ Control Panel	10
	■ Detergent	12

Washing	■ Washing (Basic Method)	14
	■ Programme List	16
	■ Details of Programmes	18
	■ Washing Tips	20

Optional Functions	■ Changing Programme Settings	22
	• Changing the temperature [↓, Water Temp]	22
	• Changing the water level [■, Water Level]	22
	• Changing the spin speed [⊙+ Spin Speed]	23
	• Setting the programme end time [⌚ Preset]	23
	■ Washing with Optional Functions	24
	• Select and run processes [📄 Mode]	24
	• Prewash [↓, Prewash]	24
	• Rinse thoroughly [⚙️ Extra Rinse]	25

■ Changing Appliance Settings	26
• Cancelling the buzzer	26
• Setting the Child Lock [Child Lock]	26
• Cancelling the “Active Foam” function	26

Maintenance

■ Maintenance	27
• Water supply filter	27
• If the water supply hose is frozen	27
• Appliance	27
• Drum	28
• Detergent drawer	28
• Drain filter	29

Troubleshooting

■ Troubleshooting	30
■ Error Display	33

Installation / Others (Ask the installation to service person)

■ Choosing the Right Location . . .	34
■ Moving and Installing.	35
■ Connecting the Hoses	37
■ Checking after Installation	39
■ Power and Water Consumption	41
■ Specifications	42

Images in these instructions are of the NA-120VX6, unless otherwise indicated.

Safety Precautions

Read and follow these safety precautions.



May cause serious injury or death.

For the safety of you and your family

- This appliance is not intended for use by persons (including children) with reduced physical, sensory or mental capabilities, or lack of experience and knowledge, unless they have been given supervision or instruction concerning use of the appliance by a person responsible for their safety.
- Children should be supervised to ensure that they do not play with the appliance.
- Keep away from fire. Do not put flammable materials or clothes with such things attached in the drum. Keep them away from the appliance. (To prevent explosion or fire)
For example: Kerosene, gasoline, benzine/thinner, alcohol, etc.
- To prevent injury, do not touch the drum until it completely stops.

Ground the appliance

- Be sure to have your dealer perform grounding work. If not provided a ground, electric shock may occur in electric leakage



WARNING

To prevent electric shock, overheating, combustion, or fire

- Use a socket that satisfies the rating requirement solely for this appliance. Do not use a plug adaptor or extension cord.
- Do not use a power cord or plug that is damaged. If the power cord is damaged, it must be replaced by the manufacturer, its service agent or similarly qualified persons in order to avoid a hazard.
- Do not plug in or unplug the power cord with wet hands.
- Always fully insert the power plug into the socket.
- Do not hold or pull on the cord when removing the plug from the socket.
- Unplug the power cord before cleaning.

Repairs

- Never disassemble, repair or modify the appliance yourself.

In case of malfunction or failure, immediately stop use, unplug the power cord, and ask your nearest service centre for repair.

Safety Precautions (continued)

CAUTION

May cause injury or property damage.

Correct use

- This appliance is only suitable for textiles labelled washing machine washable.
- Do not connect to a hot water supply.
- Do not obstruct the openings of the bottom face with carpet, etc.

To prevent water leaks

- New hose-sets supplied with the appliance are to be used and old hose-sets should not be reused.
- Turn off the tap if the appliance is not going to be used for a prolonged period, such as during a holiday. Water could leak while you are away and cause damage to household goods.

To prevent injury and burns

- Keep your fingers away from the door hinge when opening and closing the door.
- Do not climb onto the appliance.

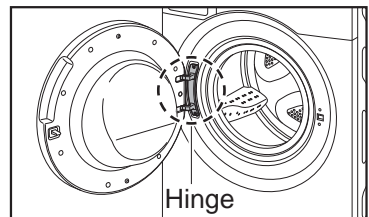



CAUTION

- When washing at high temperature, be careful not to burn yourself. Drain hose, drum, door glass, and laundry will be hot.

To prevent damage to the appliance and laundry

- Do not operate the appliance with the anchor bolts still fitted. This may cause excessive vibration of the appliance.
- Do not wash clothes that are stained with a lot of vegetable oil, cosmetic oil, etc. The oil can get hot and deform the door seal, leading to water leakage.
- Do not wash, rinse, or spin waterproof sheets or clothes. Intense vibration during spin or falling of the appliance may result in injury, damage to the main unit, wall, floor, laundry, or water leakage.
For example: Raincoats, wet suits, etc.
- The installation shall be in accordance with the requirements of AS/NZS 3500.1.

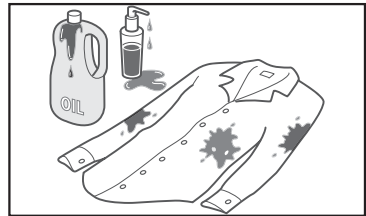

Checking Your Washing Machine

Detergent drawer (P. 12)

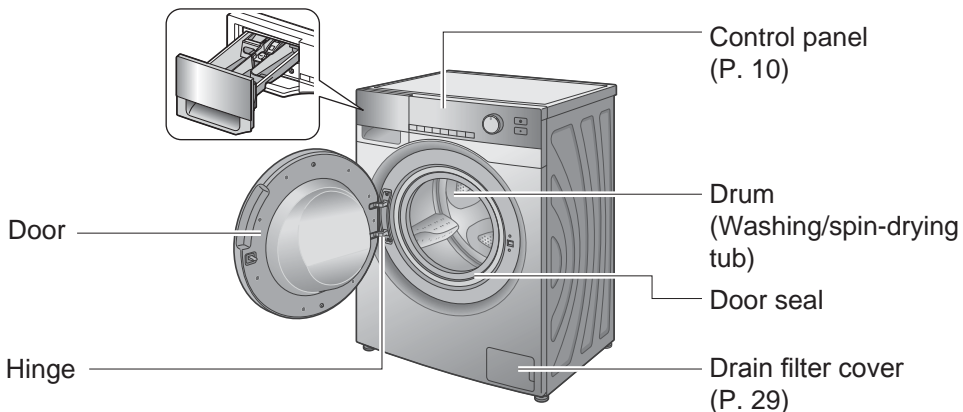

(Rear of appliance)

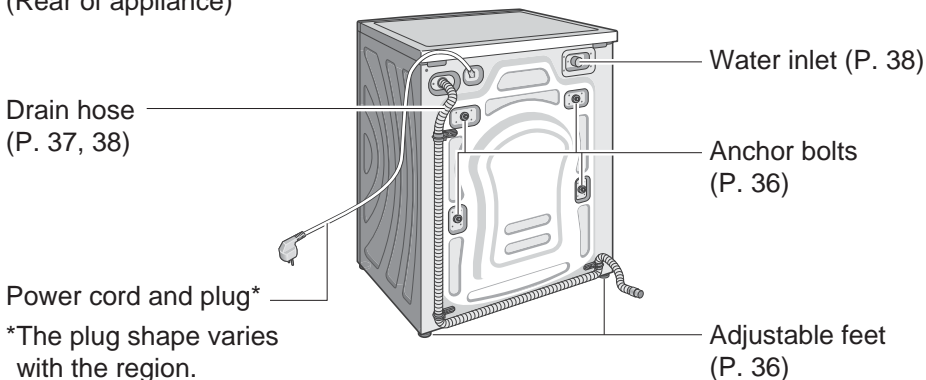

Accessories

Elbow (P. 38)



Water supply hose (P. 37, 38)



Cover caps (4) (P. 36)



Bottom plate (P. 35)

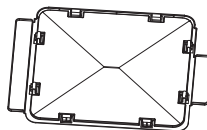

Before Washing

Check before use

When first using or after a long time of non-use, check the following.

- The water supply hose and drain hose are connected properly. (P. 37, 38)
- There is no problem in the water supply hose connection, when turning on the tap.
- The power plug is plugged in.

Before first use

There may be drops of water, or condensation, in the appliance due to the factory inspection process before shipment. To rinse away any residues etc., operate as follows:

- "Cotton" programme
- Default setting 40 °C
- No detergent, no clothing

Preparing laundry

Read the washing labels of clothes, and sort them by colour, fabric, and degree of soiling. This helps you choose a suitable programme and temperature.

■ Stained items

- Apply stain remover to any stains.
- "StainMaster+" programmes (P. 17) are recommended for removing stains. (Only for 120VX6)

■ Sorting

- Wash separately clothes that are not colour fast. (denim, dark coloured items, etc.)

■ Before put clothes in drum

To prevent damaging clothes or appliance malfunction, carry out the following steps.

- Remove foreign objects (coins, pins, clips, nails) from laundry.

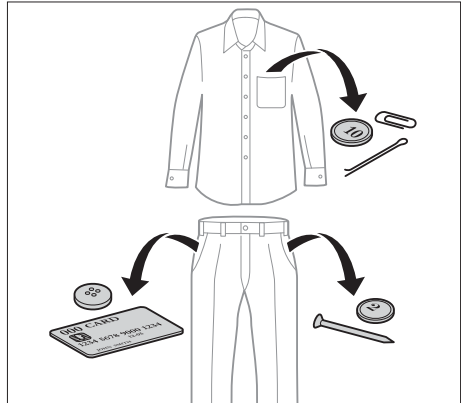

- Tie strings on aprons, etc.
- Clothing with raised fabric: Turn inside out.
- Clothing with zippers: Pull up zippers, and turn inside out.
- Small items, wired bras, and lace items: Put in a laundry net.

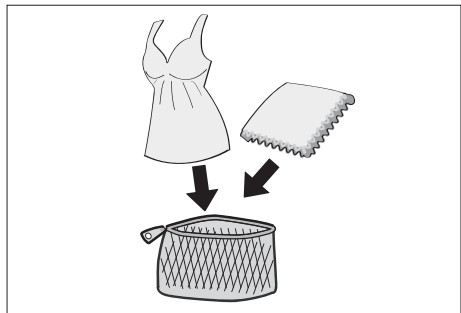

- Brush off hair, animal fur, sand etc. before washing
- Heavy dirt or deep stains: Wash lightly by hand first.

Control Panel

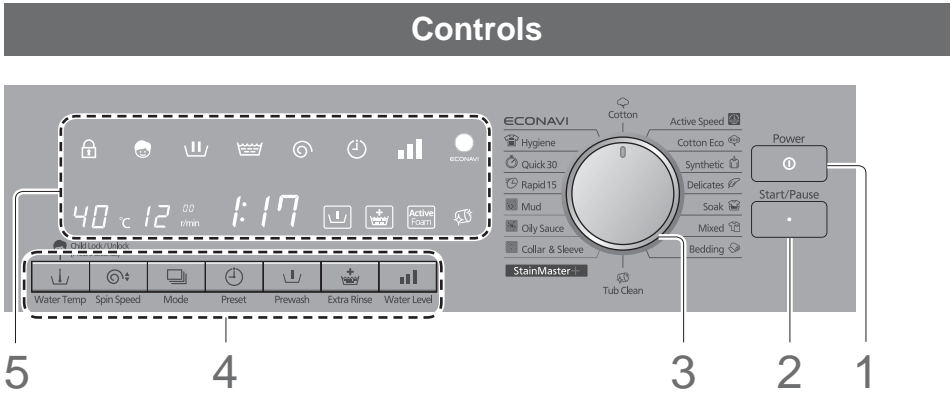

1. Power button [Power ⏻]

2. Start/Pause button [Start/Pause]

To start or pause the operation.

3. Programme selection dial

Use this dial to choose a programme suitable for the laundry. (P. 16)

4. Control buttons

To change washing settings or to select optional functions.

	Water temperature (P. 22)
	Child Lock*1 (P. 26)
	Spin speed (P. 23)
	Mode (P. 24)
	Preset (P. 23)
	Prewash (P. 24)
	Extra Rinse (P. 25)
	Water Level (P. 22)

5. Display (P. 11)

*1 Child Lock: Press and hold the button for at least 5 seconds to lock the door and other buttons.

NOTE

- To turn the power off and back on, press “Power” to switch off and make sure the display has gone off, before turning back on.

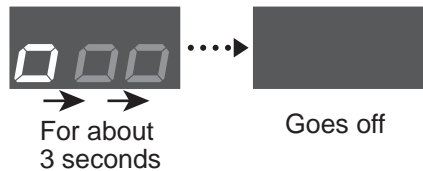

- If you do not press “Start/Pause” within 10 minutes of powering on the unit, the appliance automatically switches itself off.

Display

This illustration shows all indications for explanation purposes.

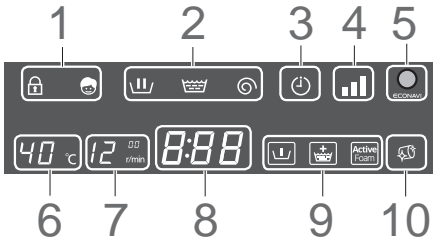

1. Lock

: The door is locked

: The door and buttons are all locked (Child Lock)

2. Process

Each indicator flashes to show the current process, and goes off when the process finishes.

	wash
	rinse
	spin

3. Preset

(P. 23)

4. Water level

5. ECONAVI lamp

Lights up while the “ECONAVI” programme is selected. Flashes during the ECONAVI detection. (P. 21)

6. Water temperature

7. Spin speed

8. Remaining time

This indicator shows the approximate time until the operation finishes.

Error display

An error is displayed if the appliance malfunctions. (P. 33)

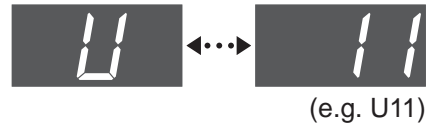

9. Optional functions

Selected optional functions are displayed. (P. 24, 25)

10. Tub Clean notice

Flashes to give notice of the time of drum cleaning after operation is performed 50 times. (P. 28)

NOTE

- In case of a power failure during operation, the appliance resumes the process from the interrupted point after the power comes back. (Auto Restart)

Detergent

- Add detergent, etc. before pressing “Start/Pause”.
- Read instructions on the packet of detergent or other agent, for correct quantity depending on the amount of laundry, degree of soiling, and water hardness.

Detergent, water softener, bleach, stain remover

- When using a tub cleaning detergent, also put it in this compartment. (P. 28)

Fabric softener

It's automatically added to laundry during final rinsing.

- Do not let it exceed “MAX” (130 ml) line.

Foam generator

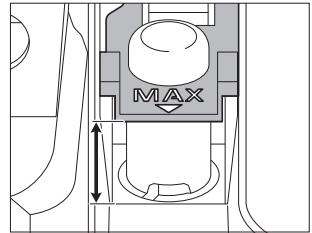

Detergent for prewashing

When using “Prewash” function (P. 24)

Detergent drawer

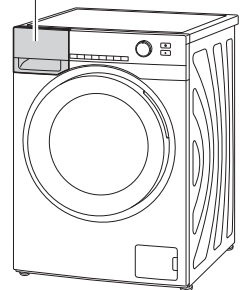
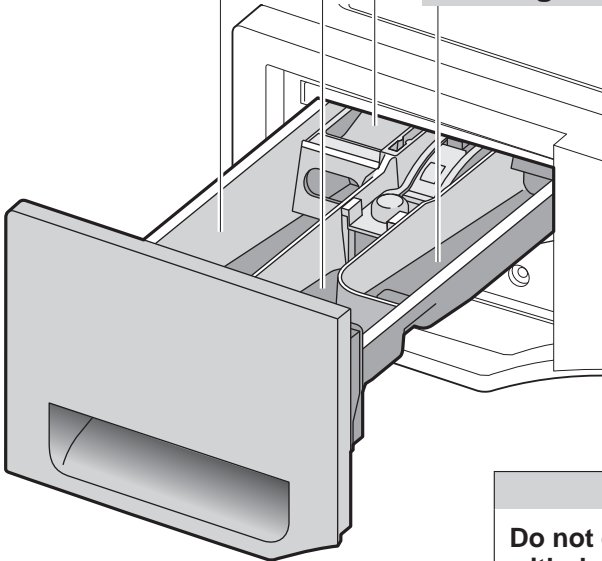

CAUTION

Do not operate this appliance with detergent drawer detached. It will leak water.

Detergent

Use a low foam detergent.

- To prevent powdered detergent from remaining in detergent drawer:
 - Dry inside the detergent drawer with a cloth.
 - Break up lumps in powdered detergent.

If powder still remains in drawer, put it directly in drum instead.

- If you forget to add detergent before starting a wash, drain water out of the drum and start again.

NOTE

- **Do not put detergent in the detergent drawer, if the instructions on the package advise that it should be put directly in the drum.**

The detergent may not flow freely, and some may remain in the drawer, causing water to overflow from the drawer.

- **Do not put detergent in the foam generator.**

■ Prewashing

- You need separate detergent for prewash and main wash.
- Use powdered detergent for main wash. Liquid detergent washes away in prewash.

Water softening agent

If you live in a hard water area (1.3 mmol/L hardness or more), we recommend using a water softening agent. This reduces the detergent required, and prevents limescale, which damages the appliance.

NOTE

- For information on water hardness, contact a specialist near you.

Fabric softener

Prevents laundry static.

- To avoid residue build up: Dilute the fabric softener prior to pouring into the machine. (do not exceed the max amount)

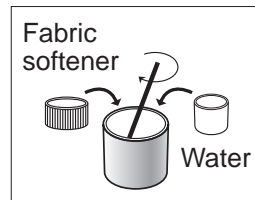

- If any softener remains in the detergent drawer after operation, you should rinse and wipe clean regularly.

Washing Basic Method

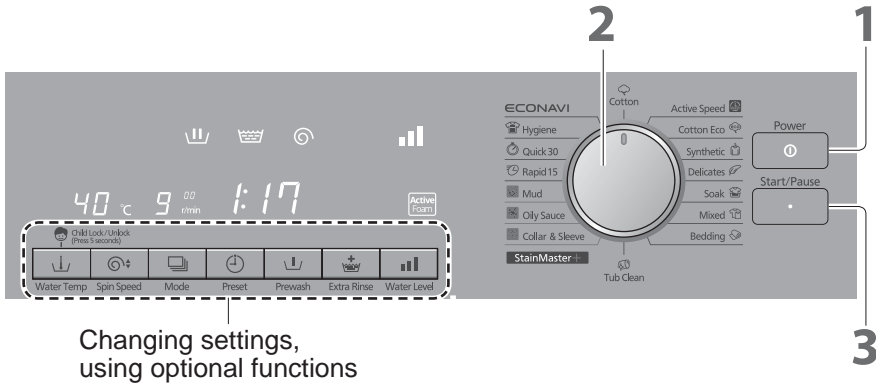

NOTE

- **Do not get laundry caught in the door.**
It can cause damage to the door seal.



- **Do not put too much laundry into the drum.**
It can cause excessive vibration or damage to the appliance, or damage to the door seal.

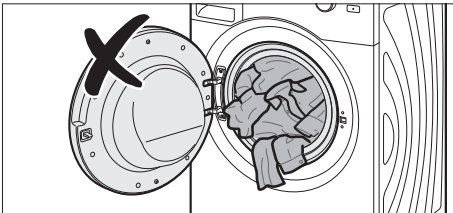

■ To open the door during operation

(The door is locked during operation)

Start/Pause **Press "Pause"**.
(The lock is released with a click)

- During spinning process, it may take about 1 minute for the drum to stop rotating.

■ Preparing

- Sort the laundry and put it into the drum. (P. 9)
- Add the detergent. (P. 12)

1  **Turn on the power.**

2  **Select a programme.**
(P. 16, 17)

The required time is displayed.

■ Changing settings

■ Using optional functions

3  **Start operation.**

- Weighing (about 30 seconds)

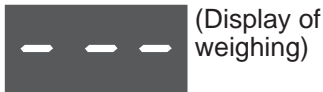

Some programmes do not weigh the laundry.
(P. 16, 17)

- Required time display (recalculated)







Operation finishes.
(The buzzer sounds and the door lock is released.)

NOTE

- Colours can run between clothes, so remove coloured laundry soon after the programme finishes.



Changing settings

After selecting a programme, you can change the following settings.

-  Water temperature (P. 22)
-  Spin speed (P. 23)
-  Preset timer (P. 23)
-  Water level (P. 22)

Using optional functions











After selecting a programme, you can add the following optional functions.

-  Mode (P. 24)
(Select and run the wash, rinse or spin process)
-  Prewash (P. 24)
-  Extra Rinse (P. 25)

NOTE









- The range of settings you can change and the optional functions you can add vary depending on the programme. (P. 18)

Programme List

Programme	Description	Max load (kg)	Time* ¹
 Cotton	For daily items of cotton, linen and cotton blends, e.g. T-shirt, underwear, towel, and tablecloth.	10.0	0:57 - 1:17
 Cotton Eco	Takes longer but consumes less energy and water than the Cotton programme.	10.0	3:23 - 5:03
 Synthetic*²	Washes chemical fibres gently.	5.0	0:53
 Delicates*²	For underwear and machine-washable silk clothes. Gentler than the Wool programme.	2.0	0:41
 Soak	For heavily-soiled clothes.	5.0	1:47
 Mixed	For blended fabrics, e.g. cotton, linen, and synthetic fibres.	10.0	1:12 - 1:47
 Bedding*²	For large items such as blankets, curtains and bedspreads.	3.0	1:21
 Wool*²	Washes gently hand washable and machine washable wool and wool blend clothes.	2.0	0:40
 Shirts*²	For shirts and women's blouses.	2.0	1:11
 Drain	Drains water out of the drum.	No clothing	0:02

NOTE





































- The required time varies depending on temperature, water pressure, drainage condition, and load size.

Programme	Description	Max load (kg)	Time* ¹	
ECONAVI	For items with mixed fabric, for example, cotton, linen and synthetic fibres. (For details, see page 21)	10.0	1:18 - 2:23	
 Active Speed	Washes faster than the Cotton programme with small load.	5.0	0:49	
 Quick 30*²	30 min. quick wash for lightly soiled cotton and linen blends.	5.0	0:30	
 Rapid 15*²	15 min. full rapid wash for a small amount of lightly soiled items.	2.0	0:15	
 Hygiene	Washes infants' clothing, tablecloths and sheets.	10.0	1:43 - 1:58	
 Tub Clean	Cleaning the drum.	No clothing	3:36	
StainMaster+ Suitable for removing stains.	 Mud	For mud stains.	10.0	2:27 - 3:12
	 Oily Sauce	For stains of oily sauce.	10.0	2:07 - 2:47
	 Collar & Sleeve	For collar and sleeve stains.	10.0	2:17 - 3:02

*1 For each programme's default water temperature.

*2 The load is not weighed after "Start/Pause" is pressed. Operation starts straight away.

Details of Programmes

Settings Programme	Available models		Auto setting			Water Temp (°C)*1	
	120VX6	120VG6	Water Temp (°C)*1	Water level	Spin speed (r/min)		
 Cotton	✓	✓	40		900	Cold, 30, 40, 50, 60	
 Cotton Eco	✓	✓	40		1200	Cold, 30, 40, 50, 60	
 Synthetic	✓	✓	30		700	Cold, 30, 40	
 Delicates	✓	✓	30		500	Cold, 30, 40	
 Soak	✓	✓	40		900	Cold, 30, 40	
 Mixed	✓	✓	40		1000	Cold, 30, 40	
 Bedding	✓	✓	Cold		700	Cold, 30	
 Wool	–	✓	Cold		500	Cold, 30	
 Shirts	–	✓	40		500	Cold, 30, 40, 50, 60	
 Drain	–	✓	–	–	–	–	
ECONAVI	✓	✓	Cold		1000	Cold, 30, 40, 50, 60	
 Active Speed	✓	✓	40		900	Cold, 30, 40	
 Quick 30	✓	✓	Cold		900	Unchangeable	
 Rapid 15	✓	✓	Cold		900	Unchangeable	
 Hygiene	✓	✓	90		900	60, 90	
 Tub Clean	✓	✓	40		900	Unchangeable	
 Mud	✓	–	40		900	Unchangeable	
 Oily Sauce	✓	–	40		900	Unchangeable	
 Collar & Sleeve	✓	–	40		900	Unchangeable	

*1 When the “Cold” is selected, nothing is displayed on the temperature indication.

*2 H:  High, M:  Medium, L:  Low

Setting range		Optional functions			
Water level* ²	Spin speed (r/min)	Mode	Prewash	Extra Rinse	Active Foam* ³
H, M, L	500, 700, 900, 1000, 1200	✓	✓	✓	✓
H, M, L	500, 700, 900, 1000, 1200	✓	✓	✓	✓
H, M, L	500, 700, 900	✓	✓	✓	✓
Unchangeable	Unchangeable	✓	–	✓	–
H, M	500, 700, 900, 1000, 1200	✓	–	✓	✓
H, M, L	500, 700, 900, 1000, 1200	✓	✓	✓	✓
H, M	500, 700	✓	–	✓	✓
Unchangeable	Unchangeable	✓	–	✓	–
H, M, L	500, 700	✓	✓	✓	✓
Unchangeable	Unchangeable	–	–	–	–
Unchangeable	900, 1000, 1200	–	–	–	✓
M, L	500, 700, 900, 1000, 1200	✓	–	–	✓
H, M, L	500, 700, 900	✓	–	–	✓
H, M, L	500, 700, 900	–	–	–	✓
H, M, L	500, 700, 900	–	–	✓	–
Unchangeable	Unchangeable	–	–	–	–
Unchangeable	500, 700, 900, 1000, 1200	✓	✓	✓	✓
Unchangeable	500, 700, 900, 1000, 1200	✓	✓	✓	✓
Unchangeable	500, 700, 900, 1000, 1200	✓	✓	✓	✓

*3 “Active Foam” works automatically with the specified programmes.

Washing Tips

“Wool” and “Delicates” programmes

■ When washing

- Place items flat on top of each other inside the drum.
- For wool items, use a mild liquid detergent.
- To rinse fully, use the “Extra Rinse” function. (P. 25)

■ When drying

- Lay out wool and nylon items flat.
- Hang out white or light-coloured wool and nylon items in the shade. (away from direct sunlight)
- Use hangers for shirts, blouses and trousers.

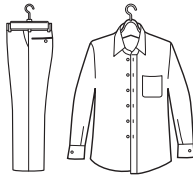

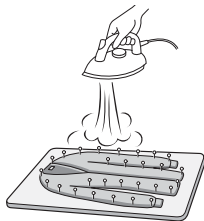

■ If items shrink in the wash

- 1 Spread the item to its original size on an ironing board.
- 2 Use dress pins to hold the size and shape.
- 3 Iron using a lot of steam and then leave the item to dry.



“Bedding” programme

■ Washable items

- Items with  (Wash) or  (Handwash) on label.
- Blankets, 100 % synthetic and 100 % cotton
- Sheets ● Bedspreads
- Undersheets, 100 % synthetic

NOTE

- You can only wash 1 item at a time.
- You cannot wash items made of wool, silk or long-pile fake fur.
- You cannot wash electric blankets.
- Do not use a laundry net. (It prevents drum rotation.)

■ Putting blankets into the drum

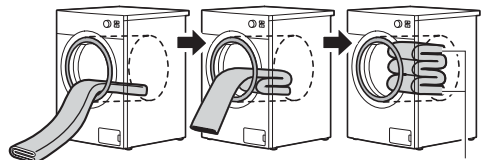
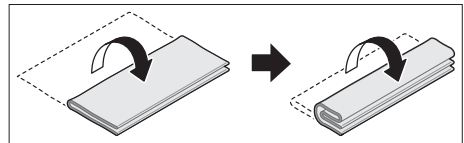

Both ends at the back of the drum

NOTE

- Do not roll blankets or bedspreads into balls or fold haphazardly. This may cause excessive vibration, damaging the appliance or laundry.

“ECONAVI” programme

This programme detects the water temperature, the laundry amount and material (cotton, chemical fibre, etc.), and determines the best suited wash time and water amount to save energy and water.

You can save time and energy more with smaller amount of laundry, or with larger amount of clothes that easily dry, such as chemical fibre, or with higher water temperature.

NOTE

- It is recommended that only dry items are put into the drum. If many wet items are loaded, ECONAVI sensing may not work properly.

“Active Foam”

The “Active Foam” works with the specified programmes as mentioned on page 19.

 lights up when the “Active Foam” is set and flashes while working.

Changing Programme Settings

■ Preparing

- Sort the laundry and put it into the drum. (P. 9)
- Add the detergent. (P. 12)

1  **Turn on the power.**

2  **Select a programme.**
(P. 16, 17)

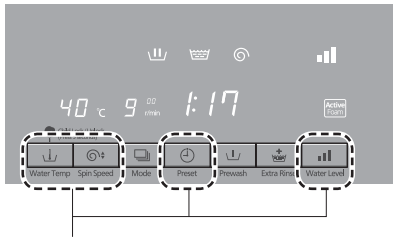

3 **Change settings of the programme.**

- The setting range depends on the programme.
(P. 18)

4  **Start operation.**

Changing the temperature

 **Water Temp**

You can change the washing temperature according to the type of laundry or the degree of soiling.

3  **Press.**

Water Temp

The temperature indication displayed changes with each press.

■ Setting guide

- Higher temperature:
Whites, cottons, heavily soiled items
- Lower temperature:
Colours, items that shrink easily, lightly soiled items

Changing the water level

 **Water Level**

You can change the washing water amount.

3  **Press.**

Water Level

The water level indication displayed changes with each press.

- : High (H)
- : Medium (M)
- : Low (L)

Changing the spin speed

Spin Speed

Change the spin speed to dry laundry more thoroughly or reduce wrinkles in laundry.

3

 **Press.**
Spin Speed

The spin speed indication displayed changes with each press.

■ Setting guide

- Higher speed:
To dry more thoroughly
- Lower speed:
To reduce wrinkling

NOTE

- You can change the spin speed after the programme starts and until the wash process ends. Pause the programme and do the steps 3 and 4.

Setting the programme end time

Preset

You can set how many hours later the washing will end.

3

 **Press.**
Preset

The time indication displayed changes with each press. Holding down “ Preset” changes the time continuously.

■ Setting range

Up to 24 hours (in increments of 1 hour)

■ To check a preset time

 **Press.**
Preset

■ To cancel settings

 **Turn off the power.**
(All settings are cancelled)

NOTE

- Be sure to close the door and press “Start/Pause” to activate the “Preset”.
- Do not use a detergent that is difficult to dissolve because it may cake up before the wash starts and not flow into the drum.
- You cannot set the end time for the “Wool”, “Delicates”, “Tub Clean”, or “Drain” programme.

Washing with Optional Functions

You can use combinations of optional functions with each programme.

■ Preparing

- Sort the laundry and put it into the drum. (P. 9)
- Add the detergent. (P. 12)

1  **Turn on the power.**

2  **Select a programme.**
(P. 16, 17)

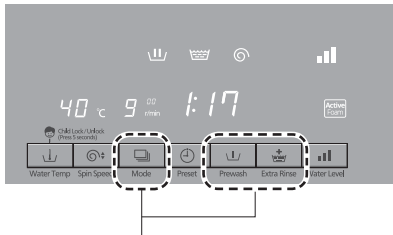

3 **Add optional function.**

- The options available differ depending on the programme. (P. 18)
- An alarm sounds if you select an option that is unavailable.

4  **Start operation.**







Select and run processes



You can select and run a combination of wash, rinse and spin processes.

3  **Press.**
Mode

The indication displayed changes with each press.

 *2	Washes
 *1	Rinses
 *1	Spins
	Washes and rinses
 *1	Rinses and spins
	Washes and spins

*1 Drains first if there is water in the drum.

*2 Water will remain.

Prewash



You can wash laundry twice by adding the prewash option. This is good for heavily soiled items.

3  **Press.**
Prewash

 lights (activated) or goes out with each press.

Rinse thoroughly

Extra Rinse

If you are concerned that some detergent may remain in your laundry, you can add an extra rinse process.

3



Press.

Extra Rinse

 lights (activated) or goes out with each press.

NOTE

- You can change the “Extra Rinse” setting after the programme starts and until the wash process ends. Pause the programme and do the steps 3 and 4.

Changing Appliance Settings

Cancelling the buzzer

You can turn off the buzzer that sounds at the end of the programme.

1  **Turn on the power.**

2  **Press for at least 5 seconds.**

The buzzer setting is cancelled after a beep.



■ To activate

Do the same operation as you did for cancelling. The buzzer setting is activated after two beeps.

Setting the Child Lock Child Lock

You can lock the door to prevent children from opening it themselves. This also locks the control buttons.

1  **Turn on the power.**

2  **Press for at least 5 seconds.**
(  lights up.)

■ To deactivate

 **Press for at least 5 seconds.**
(  disappears.)



- Ignore the beeps and keep pressing until the Child Lock is deactivated.



Cancelling the “Active Foam” function

You can disable the “Active foam” function.

1  **Turn on the power.**

2  **Select “Tub Clean”.**

3  **Press for at least 3 seconds.**
Water Level (“002” is displayed and  lights up.)

4  **Press.**
 (“002” is still on and  disappears.)

5  **Press.**
(The setting is complete and the power turns off)

■ To activate

Do the same operation as you did for cancelling.  lights up in step 4.

Maintenance

Water supply filter

Clean the filter if water is not supplied properly.



Water supply filter

- 1 Turn off the tap.
- 2 Turn on the power and start the “Cotton” programme without any laundry or detergent inside the drum.
- 3 After 1 minute, turn off the power. Water has drained out of the water supply hose.
- 4 Remove the water supply hose and clean the water supply filter.

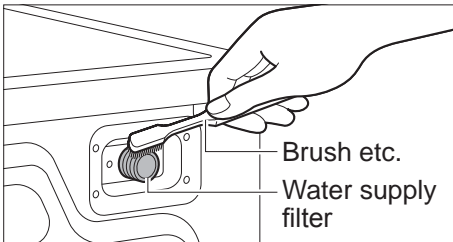

Appliance

Use a soft cloth to wipe off any water or dirt.

NOTE

- Do not splash water.
- Do not use gritty cleaners thinners, nor products containing alcohol or paraffin oil.

■ Door seal and window

Wipe off any lint or foreign objects.

■ Appliance

Wipe with a cloth and mild kitchen detergent.

If the water supply hose is frozen

- 1 Wrap warm towels around the joints of the water supply hose.

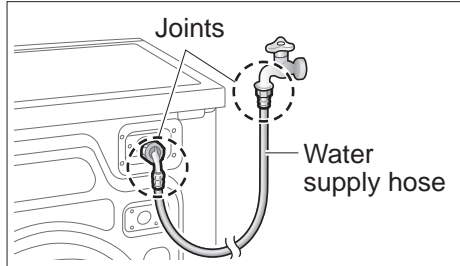

- 2 Put 2 to 3 litres of hot water (about 50 °C) into the drum.

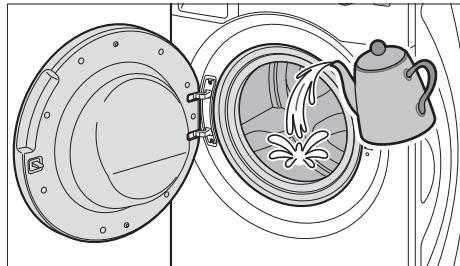

- 3 Wait for about 10 minutes, select and run the spin process in “Mode” function (P. 24).

Maintenance (continued)

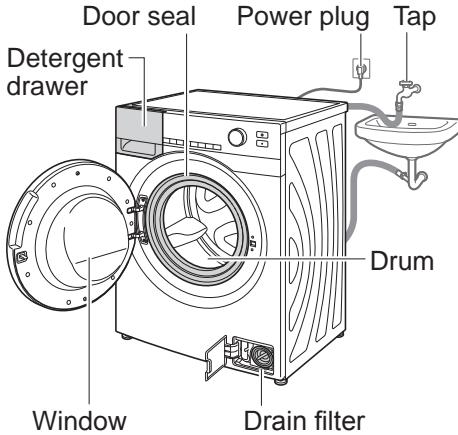

Drum

Once a month or if  flashes, run the “Tub Clean” programme with a drum cleaning detergent commercially available. The indicator goes off when the process finishes. It is also recommended to clean the detergent drawer and the drain filter.

NOTE

- If the “Tub Clean” programme is not run, the indicator  goes off when other programme is run 3 times.
- Follow the instructions of the drum cleaning detergent.
- If you use a scale remover, follow the manufacturer’s instructions.

Detergent drawer

Wash the detergent drawer with water. A build-up of detergent can develop mould.

- 1 Pull out the detergent drawer.

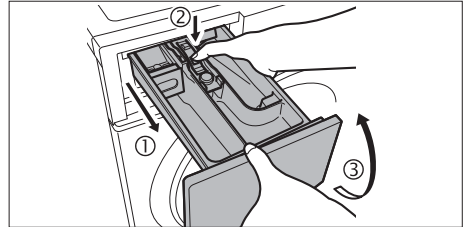

- 2 Pull laterally by both thumbs with proper force as shown by the small arrows in the figure, and push the softener cover upwards by the thumbs to remove it from the detergent drawer.

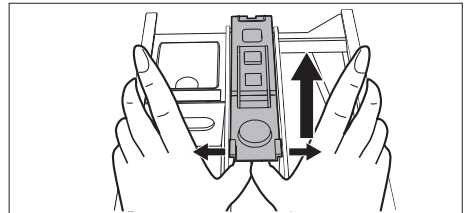

- 3 Wash the detergent drawer with water.
- 4 Replace the softener cover and detergent drawer.

Drain filter

Remove lint from the drain filter once a month. A build-up of lint can hamper drainage.

- 1 Switch off and unplug the appliance.
- 2 Open the drain filter cover on the front, and place a container to receive discharged water.

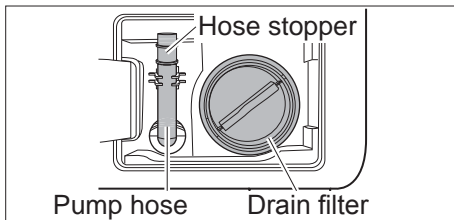

- 3 Pull out the pump hose, remove the hose stopper to drain water into the container.

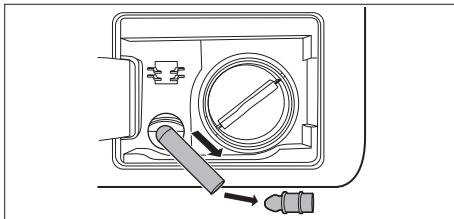

CAUTION

Do not remove the drain filter if there is water inside the drum, such as during operation. If you do, a large volume of water (possibly scalding water) will pour out.

- 4 No water being left, turn the drain filter anticlockwise to loosen and pull it out.

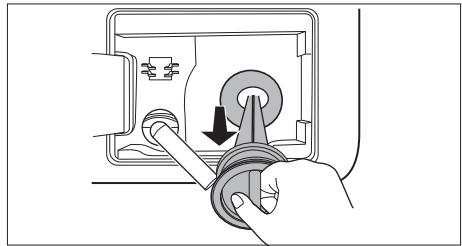
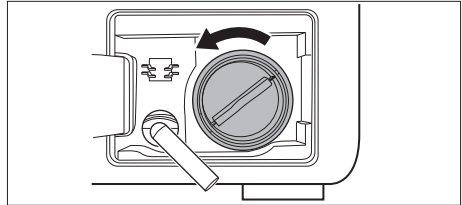

- 5 Remove any lint and debris.
- 6 Replace the drain filter.
- 7 Replace the hose stopper and pump hose and close the drain filter cover.

CAUTION

Be sure to turn the drain filter clockwise until it is in place. Otherwise, water leak may occur.

Troubleshooting





	Problem	Cause and Measures
Appliance	Buttons do not work	<ul style="list-style-type: none"> - Settings cannot be changed while an operation is in progress. Only the spin speed and “Extra Rinse” settings can be changed when the wash process is paused. - The Child Lock (🔒👤) may be activated. (P. 26)
	Door does not open	<ul style="list-style-type: none"> - The door is locked while an operation is in progress. (P. 14) - The Child Lock (🔒👤) may be activated. (P. 26) - The temperature inside the drum may be very high. - The water level may be too high. ■ To open the door immediately <ol style="list-style-type: none"> (1) Switch the appliance off and then on again. (2) Run the Spin operation (P. 24). After the water is drained and the temperature falls, you can open the door. - If you switch off the appliance or there is a power cut while the door is locked, it remains locked until the power is turned on again.
	Unusual odour	<ul style="list-style-type: none"> - Rubber parts may give off a smell when you first use the appliance, but the smell will go away over time. - Run the “Tub Clean” programme to clean the drum. (P. 28)
Wash	No water going into the appliance	<ul style="list-style-type: none"> - The tap may be turned off. - The water supply may be disrupted. - The water supply hose may be frozen. (P. 27) - The water supply filter may be blocked. (P. 27)
	Water builds up during a wash	<ul style="list-style-type: none"> - This is normal. Water is automatically supplied if the water level falls.
	Water drains out during a wash	<ul style="list-style-type: none"> - If there is excess foam, water is drained out and fresh water supplied to remove the foam. This is the foam detection function. - Even if water is directly supplied to the drum, it may drain away without building up.

	Problem	Cause and Measures
Rinse/Spin	Water is not supplied to the drum during the rinse process	- Before rinsing, the appliance spins to drain out any remaining water. Then it fills up with fresh water.
	Rinsing begins before the spin process finishes	- If the appliance detects an unbalanced load, it automatically starts rinsing to correct the imbalance. - If excess foam remains after washing, the water is drained out and refilled to wash the foam away. This is the foam detection function.
	During the spin process, the drum stops and rotates several times	- This is normal. When the appliance detects an unbalanced load, it automatically tries to correct it. - The laundry may be too light. →Try adding one or two bath towels.
	Foam or water remains on the door or door seal	- Some foam or water may remain depending on the state of the laundry or the amount of detergent used. Wipe foam or water away before taking out the laundry.
Time	The displayed remaining time changes	- The display is only a guide and is corrected continually. - The remaining time may increase if the rinse or spin settings are changed or if the appliance detects an unbalanced load and makes an adjustment accordingly.
Detergent and foam	There is not enough/too much foam	- The amount of foam varies depending on the temperature, level and softness of the water. The following can result in less foam - Powdered detergent may have been put directly into the drum. →It should be put into the detergent drawer. (P. 12) - Too little detergent may have been used. - Low foam detergent may be used. - The laundry may be heavily soiled. - The load may be large. The following can result in more foam - Too much detergent may have been used.

Troubleshooting (continued)

	Problem	Cause and Measures
Detergent and foam	Fabric softener overflows	<ul style="list-style-type: none"> - The amount of softener used may have been above the "MAX" line in the detergent drawer. (P. 12) - The detergent drawer may have been closed too strongly and spilt some of the softener.
	There is powdered detergent left on the laundry after washing	<ul style="list-style-type: none"> - Powdered detergent may have been put directly into the drum. →It should be put into the detergent drawer. (P. 12)
Noise	There is an unusual noise or vibration	<ul style="list-style-type: none"> - There may be a metal item in the drum. - The anchor bolts may not have been removed. (P. 36) - The appliance may be installed on a slope or an unstable surface. - Wet clothes may be loaded at the start of washing. →Perform spin process or wring out the laundry beforehand.
	There is noise when water drains out	<ul style="list-style-type: none"> - This is normal. It is the noise of the drain pump working.
	There is a fan rotation sound.	<ul style="list-style-type: none"> - This is normal. The fan cools electric parts.
Others	There is a power cut during operation	<ul style="list-style-type: none"> - Operation will resume from the point it had stopped when the power is recovered. (Auto restart)
	The circuit breaker trips during operation	<ul style="list-style-type: none"> - Figure out the cause and deal with it, then reset the breaker. Operation will resume from the point it had stopped when the power is recovered. (Auto restart)
	The water supply is disrupted	<ul style="list-style-type: none"> - After the water supply is restored, the water may be discoloured for a short while. →Disconnect the water supply hose, run the tap until the water is no longer discoloured, and reconnect the water supply hose. (P. 38)
	The display is unclear	<ul style="list-style-type: none"> - The appliance may be in a brightly lit or sunlit area.

Error Display

 <p>Unable to drain</p>	<p>What to do Check the drain hose for any of following problems:</p> <ul style="list-style-type: none"> - It is blocked with debris. - Hose tip is immersed in water. - It rise higher than 1 m. - Water in the pipe is frozen. <p>Clean the drain filter if blocked. (P. 29) After correcting the problem, open the door then close it, then press "Start/Pause" to restart the machine. (However, the door may not be opened due to water level; in this case, switch off the power, and then re-switch on it and restart the operation.)</p>
 <p>Door is open</p>	<p>What to do Make sure that door is closed properly. Close the door securely and press "Start/Pause".</p>
 <p>Unable to spin-dry</p>	<p>The product has been designed to detect unbalanced loads, particularly small loads, in order to ensure quiet operation and achieve the best results. This is not a malfunction. Perform any of the following solutions.</p> <p>What to do</p> <ul style="list-style-type: none"> - Please try to untangle clumps of clothing. - If you wash large items, e.g. blankets, please reduce the load. - In case of very small load, add one or two bath towels. - Please check that your product is on a stable surface. - Please adjust the feet to ensure the machine is level. <p>After correcting the problem, open the door then close it, then press "Start/Pause" to restart the machine.</p>
 <p>Unable to supply water</p>	<p>What to do Check for any of following problems:</p> <ul style="list-style-type: none"> - Supply tap is closed. - Water pipe or hose is frozen. - Water supply has been disrupted. - Water supply filter is blocked. (P. 27) <p>After correcting the problem, open the door then close it, then press "Start/Pause" to restart the machine.</p>
	<p>An error starting with "H" is displayed.</p> <p>What to do Turn off the tap just to be safe. Check the 2-digit number after "H", unplug the machine and contact a service agent of our company.</p>

Choosing the Right Location

- Make sure to ask a service person for installation. Do not install by yourself.
- If the installation, test run and inspection of the washing machine are not carried out following this installation method, Panasonic will not be liable for any accident or damage caused.

Appliance dimensions

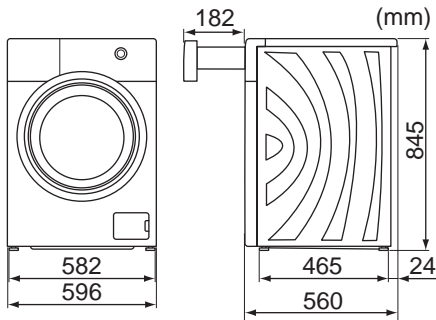

CAUTION

Do not install where temperatures may reach freezing.

■ Locations the appliance is not to be installed

- In a damp place or where the appliance may be exposed to rain, etc. (As this could cause electric shock or fire)
- Locations that are uneven, or unstable (As this could cause vibration and noise)
- In direct sunlight (As this could cause a malfunction or deformation)
- Within, or on top of, unstable surfaces, including but not limited to benchtops, timber shelving, or cabinets.

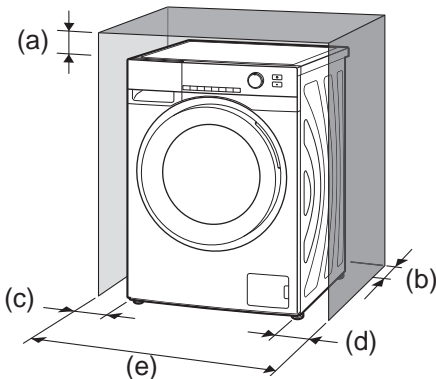

■ Set-in installation

- Install the appliance with easy access to the power plug and socket.
- Install the appliance where there is enough space around it.
 - (a): 3 mm or more above
 - (b): 5 mm or more behind
 - (c): 2 mm or more on the left side
 - (d): 2 mm or more on the right side
 - (e): 64 cm or more

CAUTION

Do NOT let metallic portions of the appliance come into contact with metal sinks or other appliances.

Moving and Installing

Carrying the appliance

Don't do it by yourself alone.



Tilt the appliance backwards, then grip the bottom of the appliance while anyone else holding the rear top.

Installation of bottom plate

Since the accessories for the bottom plate are in the upper foam pad of the package, do not dispose of it.

Upper foam pad

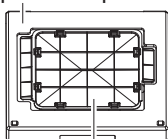

Bottom plate

The bottom plate must be installed with the FRONT mark facing frontwards.

- 1 Tilt the body backwards by about 60° and keep it stable, then place the bottom plate beneath the unit.

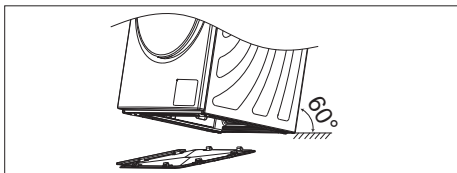

- 2 Hang the rear claws of the bottom plate to the base.

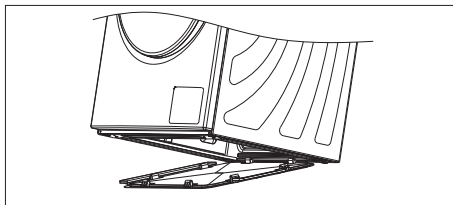

- 3 Snap the front claws into the base until they click.
- 4 Snap the left and right claws into the base securely until they click.

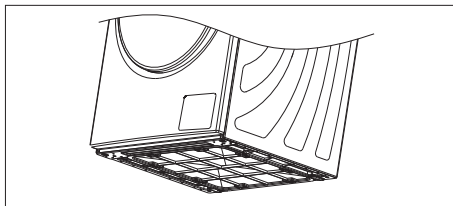

Moving and Installing (continued)

Removing the anchor bolts

The anchor bolts keep the interior of the appliance in place, and protect it from vibration during transportation.

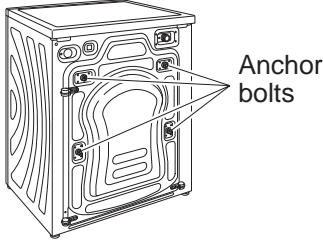

- 1 Loosen the 4 anchor bolts (4 pieces) using a spanner.

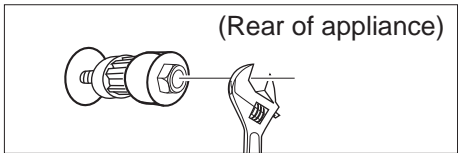

- 2 Turn the rubber part of each bolt counterclockwise and pull it out.

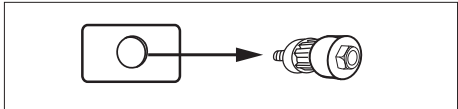

- 3 Attach the cover cap to the hole. If the caps are not attached, foreign objects may enter the appliance and cause a malfunction.

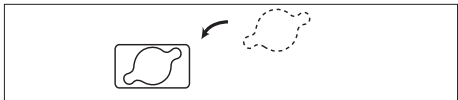

NOTE

- Operating the appliance with anchor bolts still attached will cause excessive vibration. They must be removed before operation.
- Store the anchor bolts. They will be needed when the appliance is moved again in the future.

- When moving the appliance again, the anchor bolts must be attached to the appliance. Attach the anchor bolts in the reverse order they were removed.

Levelling the appliance

Prepare a thin spanner and spirit level. (not supplied)

Use a spirit level to make sure the appliance is level.

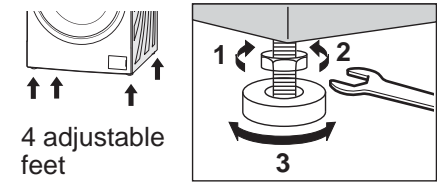
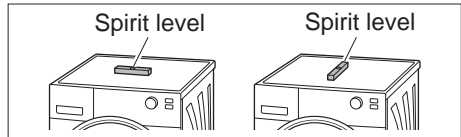

- 1 Loosen the lock nut with the spanner.
- 2 Turn the adjustable foot to adjust the height.
- 3 Tighten the lock nut.

NOTE

- Make sure that all lock nuts are tightened securely and the adjustable feet are still bolted to the appliance. If they are unbolted, the appliance will shake and move around.

Connecting the Hoses

Connect the hoses properly to prevent water leaks.
Do not overtighten hoses as this may cause leaks.

■ **Maximum connection distance of hoses and power cord**

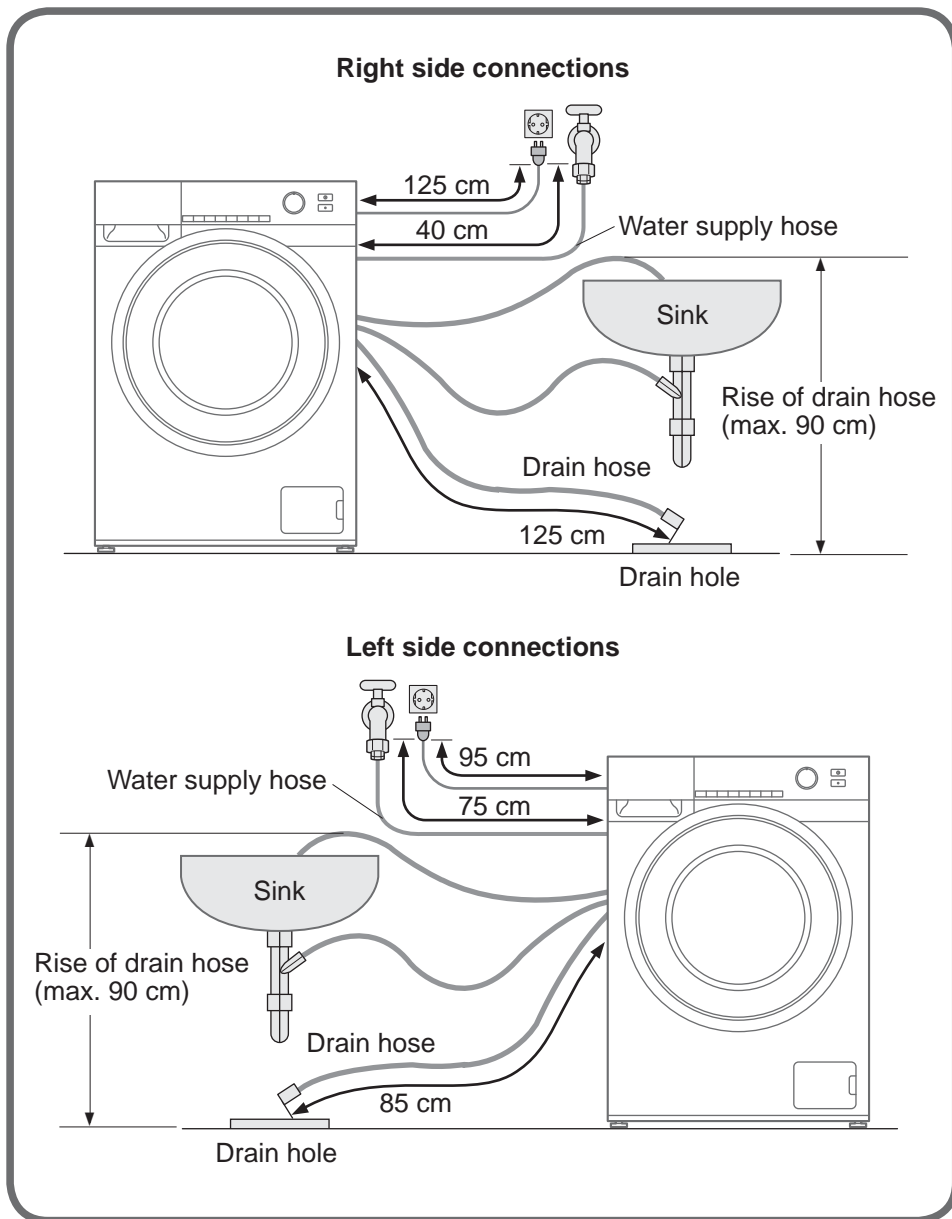

Connecting the Hoses (continued)

Water supply hose

■ Mains water pressure and water flow

- Water pressure: 0.03-1 MPa
If the water pressure exceeds this value, fit a pressure reducing valve.
- Water flow from tap: 5 L/min. or more

■ Connecting the water supply hose

CAUTION

- Do NOT twist, squash, modify or cut the hose.
- Tighten the nut firmly.

- 1 Attach one end of the hose to the water inlet on the appliance and tighten by hand.

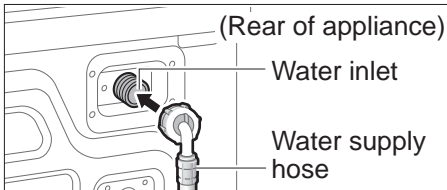

- 2 Attach the other end of the hose to the tap and tighten by hand.

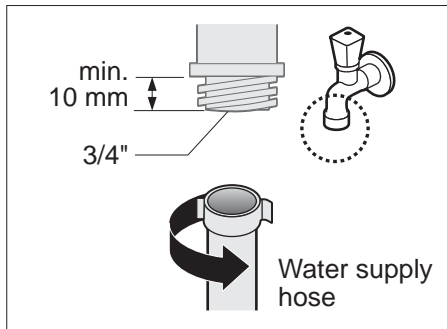

- 3 Turn on the tap slowly and make sure there are no leaks.

Drain hose

■ Draining to a sink or wash basin

CAUTION

Secure the drain hose with an elbow so that it does not come off by water pressure during drainage.

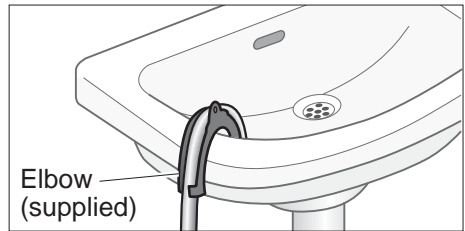

■ Draining to a stand pipe

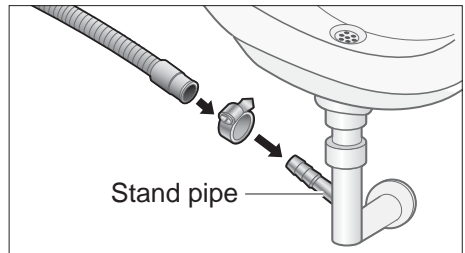

■ Draining to a drain hole

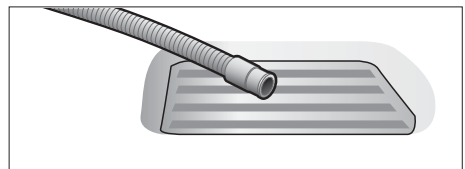

NOTE

- Do not twist, pull out or bend the drain hose.
- Do not put the hose tip under water.

Checking after Installation

Appliance parts checklist

Anchor bolts

- Have you removed all 4 anchor bolts and fitted cover caps? (P. 36)

Power plug

- Is the appliance plugged into an AC 220-240 V household socket?

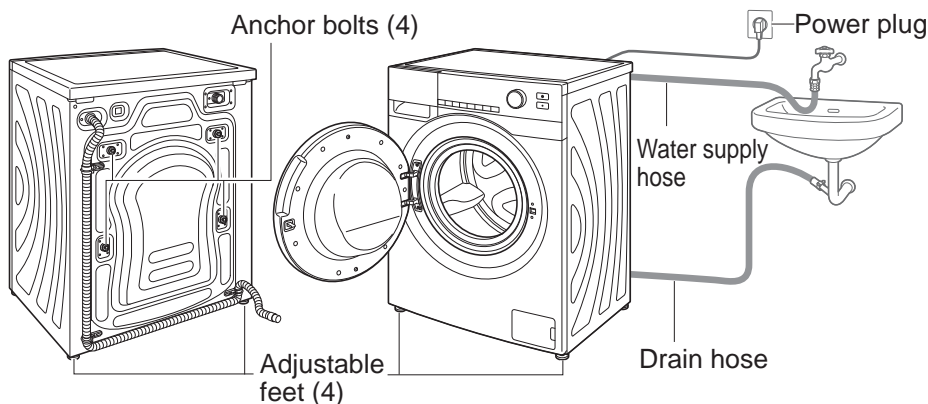

Adjustable feet

- Are they stable and securely tightened? (P. 36)
- Is the appliance level? (P. 36)

Water supply hose

- Is the water supply hose properly connected? Is it free from leaks? (P. 38)

Installation place

- Is the appliance on a flat, stable surface?
- Does it run without vibrating? (P. 36)

Drain hose

- Is the drain hose properly connected? Does it drain normally? (P. 38)

Checking after Installation (continued)

Test run

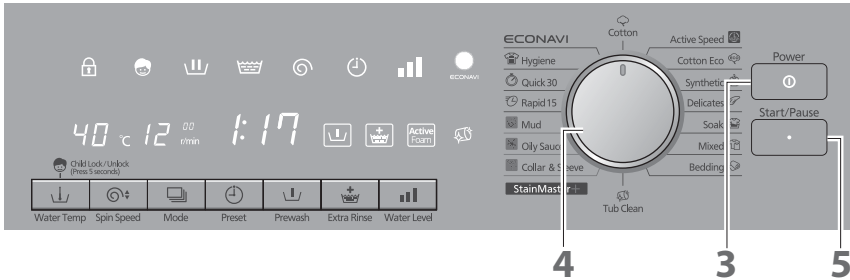

- 1 Turn on the tap.

- 2 Close the door without any laundry in the drum.

- 3  Switch on the appliance.

- 4  Select the “Rapid 15” programme.

- 5  Start operation.

Water leaks

- Check the appliance and hose joints for leaks. (P. 37)

Abnormal noise

- Make sure the appliance is level. (P. 36)



Error display

U11 Unable to drain (P. 33)

U14 Unable to supply water (P. 33)

- After resolving an error, open and close the door and press “Start/Pause” to resume the test.

Power and Water Consumption

Programme	Temperature	Water level	Load	Power consumption*1	Water consumption*1	Time*1
 Cotton	Cold	High	10 kg	0.15 kWh	95 L	1:02
	40 °C	High	10 kg	1.0 kWh	95 L	1:17
	60 °C	High	10 kg	1.5 kWh	95 L	1:32
 Cotton Eco	40 °C*2	High	10 kg	1.02 kWh	85 L	5:03
ECONAVI	Cold	High	10 kg	0.4 kWh	94 L	2:23
	40 °C	High	10 kg	1.1 kWh	94 L	2:38

*1 The power, water consumption and time indicated in the table may vary depending on variations in pressures, water hardness and temperatures, room temperatures, types and amounts of laundry, voltage fluctuations and functions to be used.

*2 Cotton Eco, 40deg, 1200 r/min is for normally cotton soiled load with AS/NZS 2040.1, AS/NZS 2040.2, AS/NZS 6400.

Specifications

Model No.	NA-120VX6	NA-120VG6
Rated voltage	220 - 240 V	
Rated frequency	50 Hz	
Maximum energy rated power input	1670 - 1990 W	
Heating energy rated power input	1610 W (230 V)	
Maximum spin speed	1200 r/min	
Product dimensions	596 mm (W) x 560 mm (D) x 845 mm (H)	
Product weight	66 kg	
Maximum mass of dry cloth	10 kg	
Water consumption	Refer to "Power and Water Consumption". (P. 41)	
Pressure of tap water	0.03 - 1 MPa	

■ Check the power supply

The rated power of the appliance is shown on the name plate. Make sure it matches the specifications of your residence.

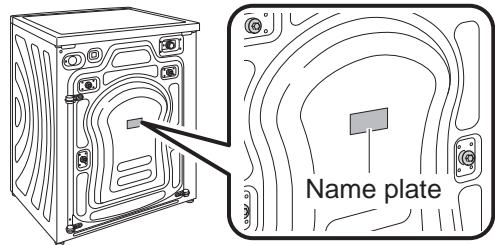

Others



W9901-3MW00

Panasonic Corporation
<http://www.panasonic.com>
© Panasonic Corporation 2017

Printed in China
12-2017
S1217-0