

User guide

DishDrawer®

DD60 models

NZ AU



Safety and warnings	3
Controls (models with no LCD)	6
Controls (models with LCD)	8
Operation	10
Wash programme chart	11
Caring for your dinnerware	12
Dishwasher standards test	13
Racking features and accessories	14
Loading suggestions	16
Detergent dispenser	18
Dishwasher detergent and tablets	19
Rinse aid dispenser	20
Option adjustments	21
Care and cleaning	24
Troubleshooting	27
Fault codes	29
Warranty and service	32

Important!

SAVE THESE INSTRUCTIONS

The models shown in this user guide may not be available in all markets and are subject to change at any time. For current details about model and specification availability in your country, please visit our local website listed on the back cover or contact your local Fisher & Paykel dealer.



Your DishDrawer® has been carefully designed to operate safely during normal dishwashing procedures. Please keep the following instructions in mind when you are using your DishDrawer®.

Important safety instructions

WARNING! - When using your dishwasher, follow basic precautions, including the following:

- ***Read all instructions before using the DishDrawer®.***
- ***The information in this manual must be followed to minimise the risk of fire or explosion or to prevent property damage, personal injury or loss of life.***
- ***Use the DishDrawer® only for its intended function as described in this user guide.***
- ***Use only detergents or rinse aid recommended for use in a domestic dishwasher and keep them out of reach of children. Check that the detergent dispenser is empty after the completion of each wash programme.***
- ***When loading items to be washed, locate sharp items so that they are not likely to damage the lid seal and load sharp knives with the handle up to reduce the risk of cut-type injuries.***
- ***Do not touch the heater plate during or immediately after use.***
- ***Do not operate your DishDrawer® unless all enclosure panels are properly in place.***
- ***Do not tamper with the controls.***
- ***Do not abuse, sit on, stand in or on the drawer or dish rack of the DishDrawer®.***
- ***The adjustable racks are designed to support cups, glasses and kitchen utensils. When the adjustable racks are in the DishDrawer® do not lean on or use them to support your body weight.***
- ***To reduce the risk of injury, do not allow children to play in or on the DishDrawer®.***
- ***Under certain conditions, hydrogen gas may be produced in a hot water heater system that has not been used for two weeks or more. HYDROGEN GAS IS EXPLOSIVE. If the hot water system has not been used for such a period, before using the dishwasher, turn on all hot water taps and let the water flow from each for several minutes. This will release any accumulated hydrogen gas. As the gas is flammable, do not smoke or use an open flame during this time.***
- ***Remove the door to the washing compartment when removing an old dishwasher from service or discarding it.***
- ***Dishwasher detergents are alkaline. They can be dangerous if swallowed. Avoid contact with skin and eyes, keep children and infirm persons away from the dishwasher when the drawer is opened.***

Important safety instructions

Installation

- *This DishDrawer® must be installed and located in accordance with the Installation instructions before it is used. If you did not receive Installation instruction sheets with your DishDrawer®, you can order them by calling your Authorised Service Agent or from the Fisher & Paykel website, www.fisherpaykel.com.*
- *Installation and service must be performed by a qualified technician.*
- *If the power supply cord is damaged, it must be replaced by a dealer or Authorised Service Centre or a similar qualified trades person in order to avoid a hazard.*
- *Ensure the DishDrawer® is secured to adjacent cabinetry using the brackets provided. Failure to do so may result in an unstable product, which may cause damage or injury.*
- *Do not operate this appliance if it is damaged, malfunctioning, partially disassembled or has missing or broken parts, including a damaged power supply cord or plug.*
- *Do not store or use petrol, or other flammable vapours and liquids in the vicinity of the DishDrawer®.*
- *Connect to a properly rated, protected and sized power supply circuit to avoid electrical overload.*
- *Make sure that the power supply cord is located so that it will not be stepped on, tripped over or otherwise subject to damage or stress.*
- *Do not install or store the DishDrawer® where it will be exposed to temperatures below freezing or exposed to weather.*
- *Do not use an extension cord or a portable electrical outlet device (e.g. multi-socket outlet box) to connect the DishDrawer® to the power supply.*

Maintenance

- *Disconnect the appliance from the power supply before any cleaning or maintenance.*
- *Do not repair or replace any part of the appliance or attempt any servicing unless specifically recommended in this user guide. We recommend that you call an Authorised Service Agent.*
- *Keep the floor around your appliance clean and dry to reduce the possibility of slipping.*
- *Keep the area around/underneath your appliance free from the accumulation of combustible materials, such as lint, paper, rags and chemicals.*
- *When cleaning the underside of the filter plate, care must be taken on the sharp outer edge to avoid the risk of cut type injuries.*

Important safety instructions

Important!

Under no circumstances should you open the drawer whilst the DishDrawer® is in operation.



Operational

- *Always press the ►|| button to pause and wait until you hear the three additional beeps before opening the drawer.*
- *The DishDrawer® must be used with the motor assembly, filter plate, drain filter and spray arm in place.*
- *When disconnecting the appliance pull the plug rather than the power supply cord or junction of cord to avoid damage.*
- *Take care when loading the DishDrawer® not to load dishware items so they prevent the lid from properly sealing with the drawer. Items should be placed so they do not protrude above and/or forced into the drawer, otherwise a service call may result.*
- *Household appliances are not intended to be played with by children. Children or persons with a disability which limits their ability to use the appliance, should have a responsible person instruct them in its use. The instructor should be satisfied that they can then use the appliance without danger to themselves or their surroundings.*
- *Close supervision is necessary if this appliance is used by or near children. Do not allow children to play inside, on or with this appliance or any discarded appliance.*
- *If a dishwasher cleaner is used, we would strongly recommend a wash programme with detergent should be run immediately afterward, to prevent any damage to the DishDrawer®.*
- *The DishDrawer® is designed for washing normal household utensils. Items that are contaminated by petrol, paint, steel or iron debris, corrosive, acidic or alkaline chemicals are not to be washed in the DishDrawer®.*
- *If the DishDrawer® is not being used for long periods of time, turn the electricity and water supply to the DishDrawer® off.*
- *Do not pour detergent or rinse aid into the salt reservoir. The detergent or rinse aid will destroy the water softener.*
- *Do not operate your appliance by means of an external timer or separate remote-control system.*

6 Controls (models with no LCD)



If you have a double DishDrawer®, each drawer has its own controls and can run independently of the other.

Power button

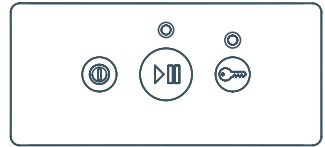
The  button turns the DishDrawer® on or off. Opening the drawer will automatically turn the DishDrawer® on for 30 seconds. To end a wash programme in mid cycle, press the  button. Any water in the DishDrawer® will be pumped out.



Start/Pause button





The  button starts a wash programme. Press the  button to pause or restart the DishDrawer® during a wash programme. When paused, wait for three beeps before opening the drawer. Forcing the drawer open while in mid cycle may cause damage or injury.



Delay start

The  button also sets the Delay start feature which can delay the start of a wash programme from 1 to 12 hours.

To activate Delay start

- 1 Press and hold the  button until the light above the  button turns orange (or purple, depending on your model).
- 2 Continue holding the  button down until the desired delay time has been reached. The DishDrawer® will emit audible 'beeps' as you hold the  button down, each beep indicates another hour delay.
- 3 The DishDrawer® will start once the delay time has elapsed and the drawer is closed.

To cancel Delay start



Press the  button.

Lock button (optional)

The  button activates/deactivates the Keylock or the Childlock functions.

Keylock



The Keylock feature disables all the buttons on the DishDrawer®.



To activate, press and hold the  button until you hear one beep (3 seconds). The light above the  button is lit when Keylock is activated.

To cancel the Keylock feature, press and hold the  button until the light above the  button disappears.

Childlock

The Childlock feature locks the drawer and disables all the buttons.

To activate, press and hold the  button until you hear two beeps (5 seconds). The light above the  button is lit when Childlock is activated.

To cancel the Childlock feature, press and hold the  button until the light above the  button disappears.

Wash programme selector

Press the  button to select a wash programme. The DishDrawer® will remember the last programme used.



Eco button *ECO* (optional)

Press the *ECO* button if you would like the wash programme to use less energy. The red ECO light will indicate the feature is on. If your dishes are heavily soiled or you require enhanced dry performance, we do not recommend ECO programmes.



Power failure

If the DishDrawer® is operating and a power failure occurs, it will stop. The DishDrawer® may be unable to be opened during this time. When the power supply is resumed, the DishDrawer® will restart in the same part of the wash programme.

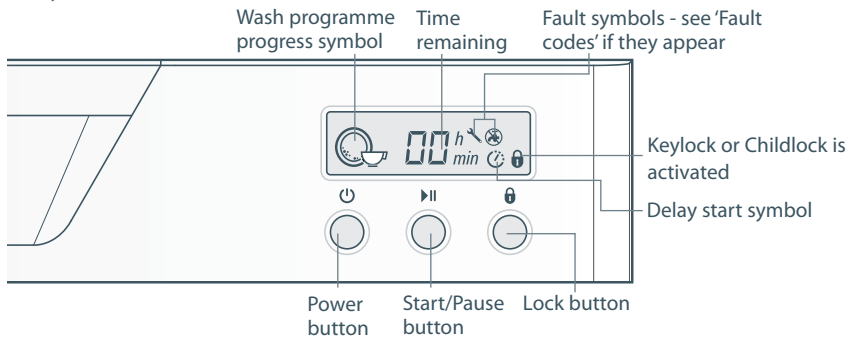

If you have a double DishDrawer®, each drawer has its own control panel and can run independently of the other.



Power button

The  button turns the DishDrawer® on or off. Opening the drawer will automatically turn the DishDrawer® on for 30 seconds. To end a wash programme in mid cycle, press the  button. Any water in the DishDrawer® will be pumped out.



Start/Pause button

The  button starts a wash programme. Press the  button to pause or restart the DishDrawer® during a wash programme. When paused, wait for three beeps before opening the drawer. Forcing the drawer open while in mid cycle may cause damage or injury.

Delay start

The  button also sets the Delay start feature which can delay the start of a wash programme from 1 to 12 hours.

To activate Delay start

- 1 Press and hold the  button until the delay symbol  appears on the electronic display.
- 2 Continue holding the  button down until the desired delay time has been reached.
- 3 The DishDrawer® will start once the delay time has elapsed and the drawer is closed.

To cancel Delay start



Press the  button.

Lock button (optional)

The  button activates/deactivates the Keylock or the Childlock functions.



Keylock



The Keylock feature disables all the buttons on the control panel.

To activate, press and hold the  button until you hear one beep (3 seconds). The  symbol appears in the electronic display when the Keylock feature is activated.

Childlock

The Childlock feature locks the drawer and disables all the buttons on the control panel.

To activate, press and hold the  button until you hear two beeps (5 seconds). The  symbol appears in the electronic display when the Childlock feature is activated.

To cancel the Childlock feature, press and hold the  button until you hear one beep and the  symbol disappears from the electronic display.

Wash programme selector

Press the  button to select a wash programme. The DishDrawer® will remember the last programme used.



Eco button *ECO* (optional)

Press the *ECO* button if you would like the wash programme to use less energy. The red ECO light will indicate the feature is on. If your dishes are heavily soiled or you require enhanced dry performance, we do not recommend ECO programmes.

Wash programme progress symbols

As the wash programme advances through the cycle, the following symbols will appear in the electronic display to indicate the progression. When a wash programme has started, the electronic display also will count down the time remaining in one minute increments.

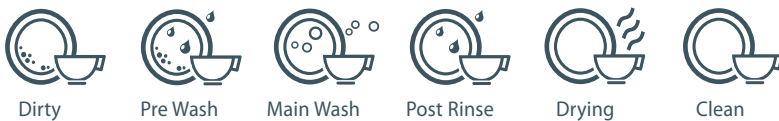

Power failure

If the DishDrawer® is operating and a power failure occurs, it will stop. The DishDrawer® may be unable to be opened during this time. When the power supply is resumed, the DishDrawer® will restart in the same part of the wash programme.

10 Operation

1 Load dishes

Remove all food scraps and load the dishes.

2 Add detergent

3 Check rinse aid

4 Press the button

5 Select a wash programme

The length of the wash programme will appear on the electronic display (models with LCD only).

6 Select *ECO* (optional)

7 Check

Ensure there is nothing obstructing the spray arm. The drain filter must be level with the filter plate.

8 Start

Close the drawer and press the  button.

9 Finish

The DishDrawer® will beep six times to indicate the end of the wash programme. At the end of the wash programme the drying fan will continue to run for a set time or until the drawer is opened. The fan assists with drying and uses negligible amounts of energy. It is normal for some water to remain in the drain filter area after the wash programme is complete.

Double models only: At the end of a wash programme, you may find both drawers draining simultaneously. This is normal.

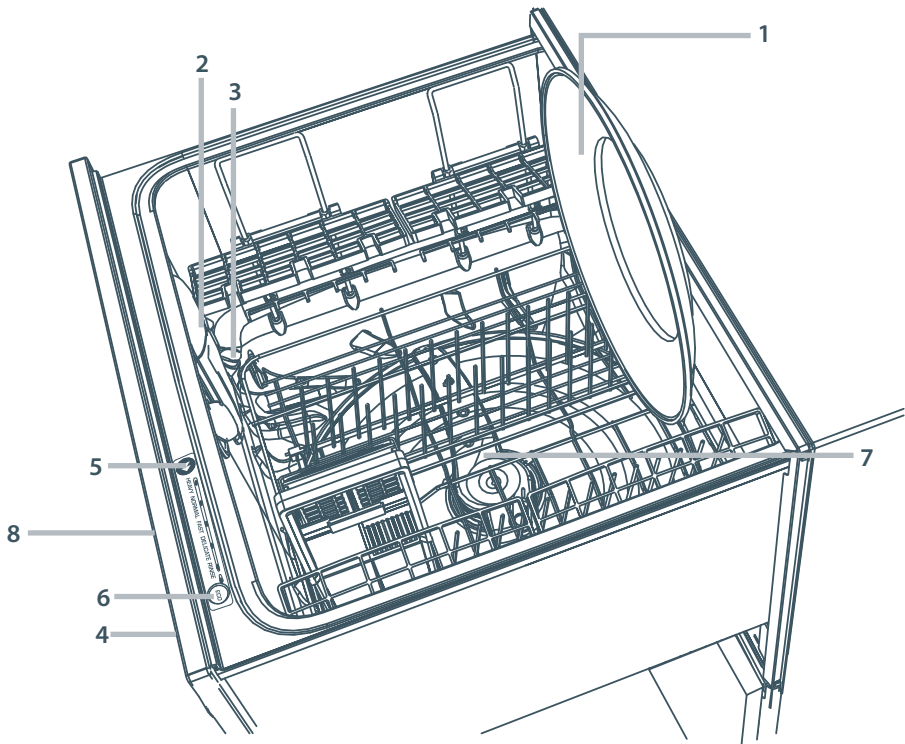

Standard wash programme - when to use

Heavy <i>Heavily soiled pots, pans and dishes.</i>	Normal <i>Dishes with normal soils for optimum wash and dry performance. Also the only recommended programme if you are using dishwasher tablets. </i>	Fast <i>Lightly soiled dishes.</i>	Delicate <i>Lightly soiled and heat sensitive crockery.</i>	Rinse <i>Prevents odours and soils drying on dishes.</i>
--	---	--	---	--

pre wash 45°C			pre wash	
pre wash			pre wash	
main wash 70°C	main wash 55°C	main wash 55°C	main wash 50°C	
post rinse	post rinse	post rinse	post rinse	
final rinse 65°C	final rinse 65°C	final rinse 50°C	final rinse 60°C	
drying phase	drying phase		drying phase	

Eco wash programme - when to use

Heavy <i>Heavily soiled everyday dishes.</i>	Normal* <i>Normal soiled dishes for optimum energy use.</i>	Fast <i>Lightly soiled, non greasy dishes.</i>	Delicate <i>Lightly soiled, non greasy and heat sensitive crockery.</i>
--	---	--	---

pre wash 35°C			
pre wash			pre wash
main wash 60°C	main wash 40°C	main wash 45°C	main wash 45°C
post rinse	post rinse	post rinse	post rinse
final rinse 55°C	final rinse 43°C	final rinse 45°C	final rinse 50°C
drying phase	drying phase		drying phase

Note

*Reference programme for energy label in compliance with AS/NZS 2007.

Wash times can vary depending on the incoming water temperature, ambient conditions, type of dish load and whether the drawer has been opened during the wash. Wash times are only APPROXIMATE on the electronic display and based on 20 °C incoming water.

12 Caring for your dinnerware

The combination of high temperatures and dishwasher detergent may cause damage to some items if they are washed in the DishDrawer®. Remember, if in any doubt about any aspect concerning items washed in the DishDrawer®, follow the instructions from the manufacturer of the items, or wash the item by hand.

Cutlery & silverware

All cutlery and silverware should be rinsed immediately after use to prevent tarnishing caused by some foods. The Rinse wash programme is useful for this. Silver items should not come into contact with stainless steel, eg other cutlery. Mixing these items can cause staining. Remove silver cutlery from the DishDrawer® and hand dry it immediately after the programme has finished.

Aluminium

Aluminium can be dulled by dishwasher detergent. The degree of change depends on the quality of the product.

Other metals

Iron and cast iron objects can rust and stain other items. Copper, pewter and brass tend to stain.

Woodware

Wooden items are generally sensitive to heat and water. Regular use in the dishwasher may cause deterioration over time. If in doubt, wash by hand.

Glassware

Most everyday glassware is dishwasher safe. Crystal, very fine and antique glassware may etch that is, become opaque. You may prefer to wash these items by hand.

Plastic

Some plastic may change shape or colour with hot water. Check manufacturer's instructions about washing plastic items. Washable plastic items should be weighed down so they do not flip over and fill with water or fall through the base rack during the wash.

Decorated items

Most modern china patterns are dishwasher safe. Antique items, those with a pattern painted over the glaze, gold rims or hand painted china may be more sensitive to machine washing. If in doubt, wash by hand.

Glued items

Certain adhesives are softened or dissolved in machine washing. If in doubt, wash by hand.

Holiday time

If the DishDrawer® is not going to be used for some time, we recommend you leave the DishDrawer® clean and empty. Leave the drawers ajar to allow air to circulate. Turn off both the power and water supply to the DishDrawer®.



The DishDrawer®s are tested to AS/NZS 2007 standards for both wash and dry performance. The following are loading pattern diagrams, detergent quantities and rinse aid quantities used for the DishDrawer®.

Wash programme	Normal Eco (At the end of the programme, open the DishDrawer 50 mm to improve the dry performance.)
Detergent quantities	22.5g (main wash) per drawer
Rinse aid setting	4
Maximum place setting (per drawer)	6
Accessories to be used in the Dishwasher standards test	Base rack, drain filter access panel, folding tines, 'slide-and-fold' tines, cutlery basket, adjustable racks, glass supports.

Height setting of adjustable racks

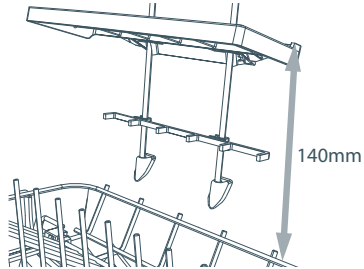

Correct orientation of glass supports on both sides of drawer

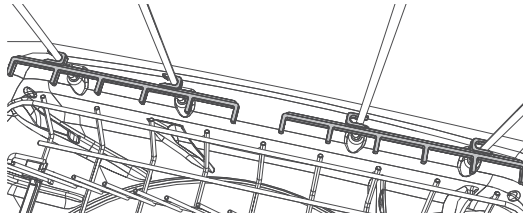

Recommended loading pattern

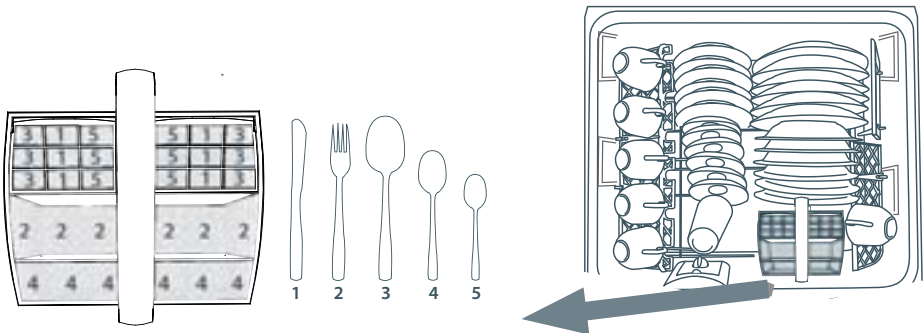

Cutlery basket

- Mix spoons, knives and forks within each section to stop cutlery nesting together.
- Most cutlery is placed with the handle pointing down.
- For your safety, knives and sharp utensils should have their handles up.
- Small light items like baby bottle teats are best placed under the anti-nesting grids to prevent them from being displaced.

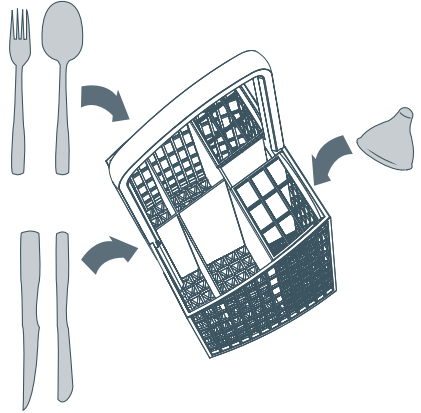

Stemware notches

- The six notches on the left-hand side help support long-stemmed glassware.

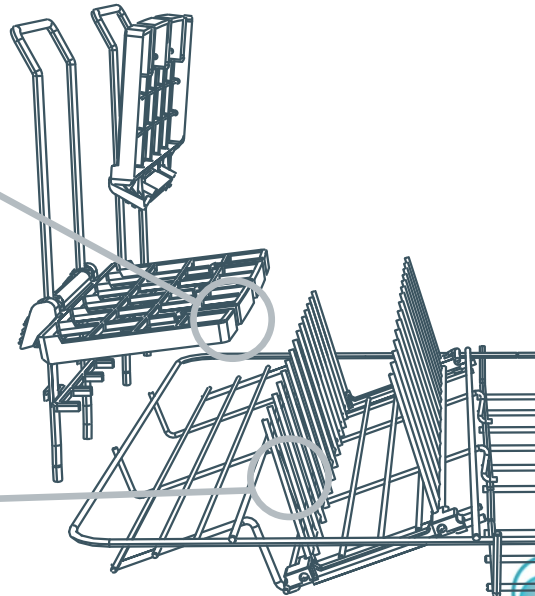
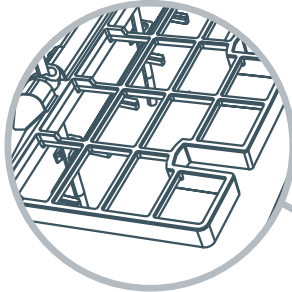

Folding tines

- The front half is ideal for large, deep bowls.
- Fold the tine sections down towards each other if you need the space for pots or other large items.
- Fold down the right-hand section only and lean cups against the upright tines for extra stability.

Adjustable racks

- You can adjust these independently of each other to any height:
 - 1 Fold up to unlock the rack.
 - 2 Adjust the height to suit by sliding up or down.
 - 3 Fold down to lock in position.
- Fold the racks away if you need the space.

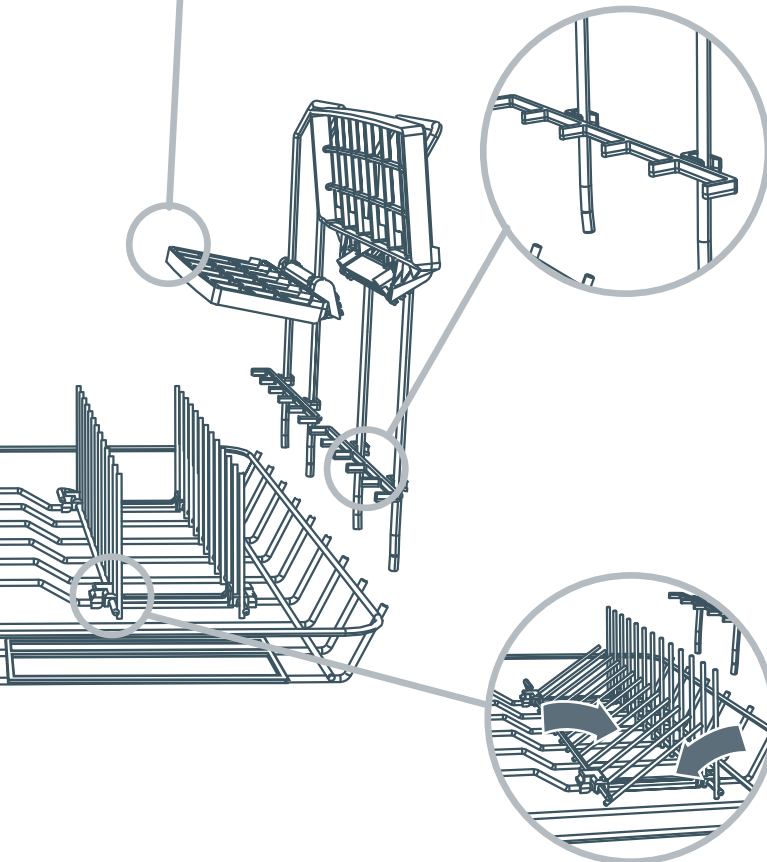
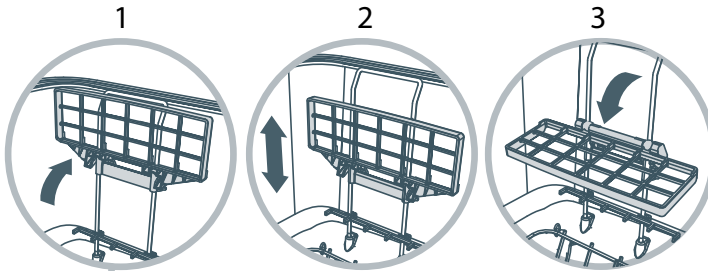

Glass supports

- These clip on the rack wires to give your tall glasses extra stability.

'Slide-and-fold' tines

- Slide all the way to the left to fit larger dinner plates.
- For optimum stability, place larger plates between the longer tines in the front.
- Fold the tine sections down towards each other if you need the space for pots or other large items.

16 Loading suggestions

When loading your DishDrawer®, make sure that

- you place items so that water coming from the rotating spray arm below can reach all areas (wash performance will be reduced if it can't)
- nothing blocks the water from getting to items on the adjustable racks.

Typical breakfast load

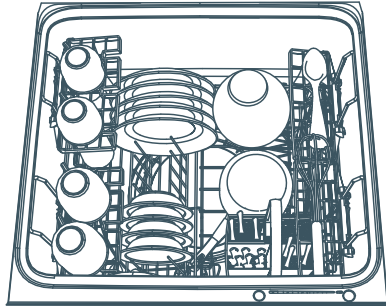

Typical dinner party load

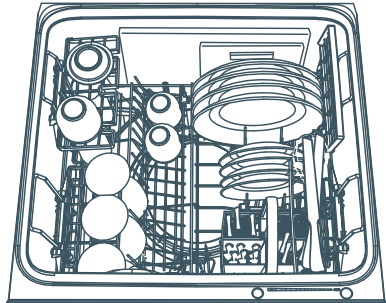

Typical heavy load

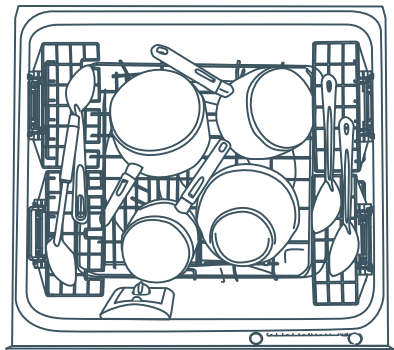

How NOT to load your DishDrawer®

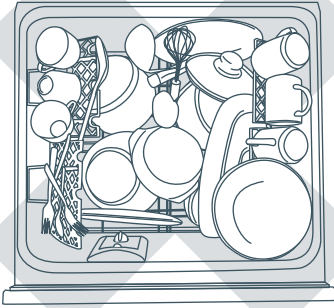

- Overcrowded and wash water will not reach some of the dinnerware.
- Cups, glasses and bowls must have their openings facing down.

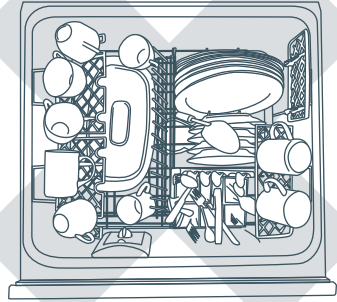

- The plates are nesting together and wash water may not get through.
- Ensure cutlery are not nesting or stuck together. They need to be evenly spread out.

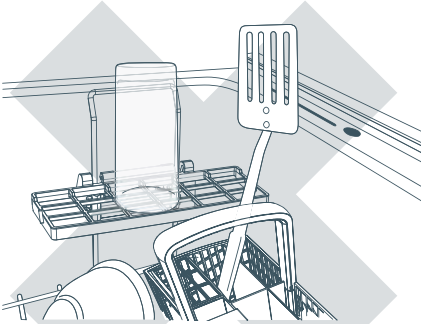

- Ensure dishware items are not forced into or protrude out of the drawer, as this may prevent the lid from properly sealing which could result in a service call.
- Locate sharp items safely to prevent injuring the user and damaging the lid assembly.
- Check the bottom of the cutlery basket to ensure sharp or pointed items have not come through as they may stop spray arm rotation.

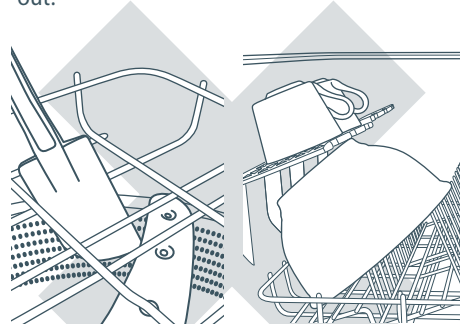

- Ensure cutlery has not fallen through the base rack and stopped the spray arm from rotating.
- The large bowl is blocking wash water reaching the adjustable racks.
- Large utensils should be on the adjustable racks so they do not become dislodged and stop the spray arm from rotating.
- Sharp or pointed items must be placed horizontally or with sharp edges/points facing down to avoid risk of injury.

Important!

- Only use powdered detergent recommended for domestic automatic dishwashers in the detergent dispenser.
- Dishwasher detergents are strongly alkaline and can be dangerous if swallowed.
- Avoid contact with skin and eyes.
- Keep children and infirm persons away from the DishDrawer® when the drawer is open.
- Check that the detergent receptacle is empty after completion of the wash cycle. Failure to do so could result in poisoning.
- Do not place dishwasher tablets in the detergent dispenser.
- Detergent and dishwasher tablets should not be in direct contact with dishes or cutlery.
- Liquid detergents are not suitable to be used in the DishDrawer®.
- Hand washing liquids, soap, laundry detergents or disinfectants will damage the DishDrawer®.

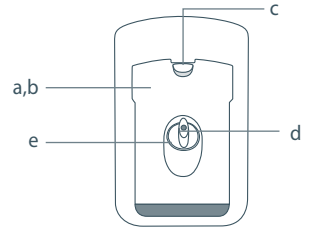

Closed detergent dispenser

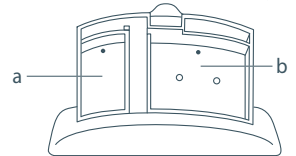
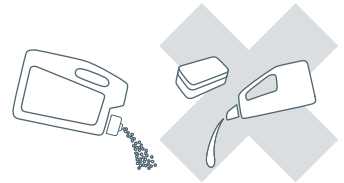

Open detergent dispenser

- ### Filling the detergent dispenser
- 1 Press the latch down and the door will open.
 - 2 Pour in detergent. No detergent is needed for the Rinse programme.
 - 3 After filling the main wash compartment, close the dispenser door until it clicks shut. The detergent will automatically be released into the DishDrawer® during the wash programme.

- a Pre-wash compartment, 10g capacity
- b Main wash compartment, 30g capacity
- c Detergent dispenser latch
- d Rinse aid indicator light
- e Rinse aid plug

Detergent quantities

The detergent quantities recommended below are for individual drawers.

Wash programmes	pre-wash (g)*	main wash (g)*
Heavy	5	15
Normal		15
Delicate		5
Fast		5

* 5g equates to approximately 1 teaspoon, 15g equates to approximately 1 tablespoon.

Dishwasher tablets

Important!

If you are using dishwasher tablets, we recommend you use the standard Normal programme only. Using any other programme (including Normal Eco) with dishwasher tablets will not ensure optimum wash performance.



Tablets can either be placed in the cutlery basket or alternatively, placed directly in the wash compartment as below. If you are using dishwasher tablets with a built-in rinse aid component, you may need to reduce the rinse aid setting. See 'Option adjustments' for instructions.

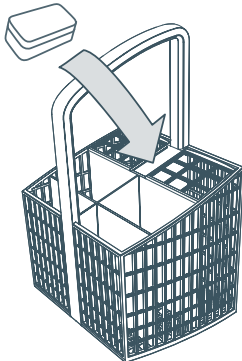

Preferred:

Place the dishwasher tablet in the empty section between the anti-nesting grids.

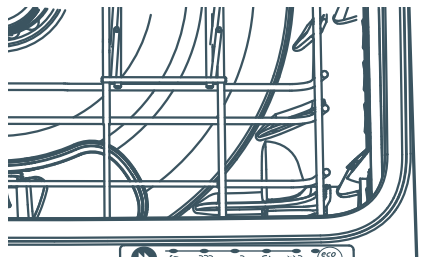

Alternative:

If the cutlery basket cannot be used, place dishwasher tablet in the bottom of the wash compartment.

20 Rinse aid dispenser

We highly recommend the regular use of liquid rinse aid to give the best drying results. Rinse aid gives a streak-free, sparkling clean look to glass and chinaware. In addition, it prevents metal from tarnishing. The rinse aid dispenser is on the inside of the drawer, located underneath the detergent dispenser. The rinse aid dispenser holds approximately 50 ml of rinse aid.

Filling the rinse aid dispenser

- 1 Turn the plug anticlockwise and remove.
- 2 Pour the rinse aid into the circular opening.
- 3 Take care not to spill rinse aid into the DishDrawer®. Any spillages must be wiped up to prevent excess foaming. Failure to wipe rinse aid spillages may result in a service call which will not be covered by warranty.
- 4 Fit the plug back into the original position.

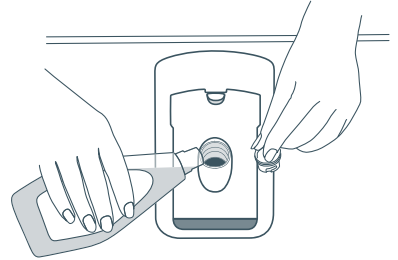

How much rinse aid to use

The regulator may need adjusting to suit your water conditions or the particular dishwasher tablet you are using. The lowest setting is '1' and the highest is '5'. Refer to the 'Option adjustments' section to adjust the rinse aid setting. If there is excessive foam at the end of the wash or you are using dishwasher tablets with built-in rinse aid, reduce the setting. If dishes are wet or streaky after drying, increase the setting.

Rinse aid indicator light

If the rinse aid indicator light is red, refill the dispenser. If the rinse aid indicator light is dimly lit or not lit at all, there is enough rinse aid for the wash.

Note:

- Lighter coloured rinse aids will not dim the indicator light as effectively as darker coloured rinse aids.
- When the rinse aid is being dispensed, you may notice some unusual noises during the wash: this is normal.

The following options can be adjusted to suit your preferences:

Rinse aid setting

Reduce the Rinse aid setting if there is excess foam after a wash programme or if you are using dishwasher tablets with built-in rinse aid.

Increase the Rinse aid setting if dishes are wet or streaky after a wash programme.

Water softener setting

Refer to the 'Water softener' section.

Auto power setting

By default, DishDrawer® will automatically turn on whenever the drawer is opened. Washing will not start until the drawer is closed and the ►|| button has been pressed. If you do not want the DishDrawer® to turn on automatically, this feature can be turned off.

End of wash programme beeps

By default, DishDrawer® will beep six times at the end of a wash programme. This feature can be turned off.

Closed drawer option

The Closed drawer option will lock the DishDrawer® when the drawer is closed. When you wish to open the drawer, press the ⏸ button. When the drawer is fully closed again, the lid will automatically come down after 30 seconds and lock.

If the Keylock feature is used in conjunction with the Closed drawer option, pressing the ⏸ button will not unlock the drawer. The Keylock feature must be turned off to enable DishDrawer® to be opened.

Note: this option is highly recommended if the DishDrawer® is to be used in motor homes.

Clean dish indicator option (models with LCD only)















By default, DishDrawer® is programmed with the Clean dish indicator option off. When the Clean dish indicator option is on, the ☐☐ symbol will remain in the electronic display after a wash programme has finished to indicate the dishes are clean. When you have unloaded all the dishes, press the ⏸ button to return to normal operating mode.

This option might be useful when dishes have been left in DishDrawer® and you cannot remember if they have been washed or in situations where household members regularly remove only a few clean dishes without emptying the drawer.

We do not recommend the Clean dish indicator option be used in conjunction with the Closed drawer option.



How to make option adjustments (Integrated and Prefinished - no LCD)

Follow the steps below	Rinse aid setting	Auto power option	End of wash programme beeps option	Closed drawer option*
<p>First</p> <p>Enter Option adjustment mode:</p> <ol style="list-style-type: none"> 1 Press the  button to turn power on. Open DishDrawer®. 2 Press and hold the ECO and  buttons for 5 seconds until one long beep sounds. 	<p>Prefinished - no LCD red / off</p> <p>Integrated - no LCD red / off</p>	<p>purple / on</p> <p>orange / on</p>	<p>blue / on</p> <p>green / on</p>	<p>red / on</p> <p>red / on</p>
<p>Press the  button to scroll through options</p>				
<p>Make an adjustment</p> <p>The current setting is shown on the wash programme selector in red lights. If four red lights are lit, the option selected setting is set to 4. Press the  button to increase the setting.</p>		<p>Press the  button to turn the selected option on or off.</p>		
<p>Save</p>	<p>Press the  button to save the change.</p>			
<p>Example</p> <p>Rinse aid setting set to 4</p>		<p>On</p> 	<p>On</p> 	<p>Off</p> 

* The option sequence will start again from the Rinse aid setting.



How to make option adjustments (models with LCD)

Follow the steps below	Rinse aid setting	Auto power option	End of wash programme beeps option	Closed drawer option	Clean dish*
First	Enter Option adjustment mode: 1 Press the U button to turn power on. Open the DishDrawer®. 2 Press and hold the ECO and U buttons for 5 seconds until one long beep sounds.				
Press the ▶ button to scroll through options	rA	RP	EC	Ld	d5
Make an adjustment	The current setting is shown on the wash programme selector in red lights. If four red lights are lit, the option selected setting is set to 4. Press the U button to increase the setting.				
Save	Press the U button to save the change.				
Example	 RINSE AID SETTING RINSE aid setting set to 4	RP On RP Off	EC On EC Off	Ld On Ld Off	d5 On d5 Off

*The option sequence will start again from the Rinse aid setting.



Important!

Disconnect the DishDrawer® from the power supply before any cleaning or maintenance.

Cleaning the surfaces

Important!

We do not recommend the use of the following cleaning aids on your DishDrawer® as they may damage the surfaces:

- *Plastic or stainless steel scouring pads*
- *Abrasive, solvent, household cleaners*
- *Acid or alkaline cleaners*
- *Hand washing liquids or soap*
- *Laundry detergents or disinfectants*
- *Proprietary 'Stainless Steel' cleaners or polishes as these may damage the protective coating.*

- 1 Wipe with a clean damp cloth. Take care not to wet the control panel.
- 2 Dry with a clean lint-free cloth.

Cleaning the drain filter, spray arm and filter plate

We recommend that the drain filter is cleaned whenever there is evidence of food particles. The spray arm and filter plate may need cleaning about once a month in normal use or more often should the need arise.

If a dishwasher cleaner/descaler is used, you must run a wash programme with detergent immediately afterward to prevent any damage to your DishDrawer®.

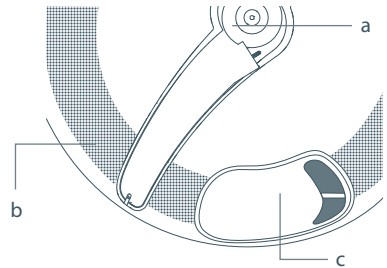

Internal parts of the DishDrawer® :

- a Spray arm
- b Filter plate
- c Drain filter

Important !

The DishDrawer® must be used with the filter plate, drain filter and spray arm correctly in place.

Cleaning the drain filter

- 1 Unplug the DishDrawer® or turn it off at the power supply (wall switch).
- 2 Lift up the drain filter access panel on the base rack (if fitted).
- 3 Lift and remove the drain filter.
- 4 Empty, rinse clean under running water and replace back into the allocated space.
- 5 Ensure the drain filter is flush with the filter plate.
- 6 Plug the DishDrawer® back in or turn it on at the power supply (wall switch).

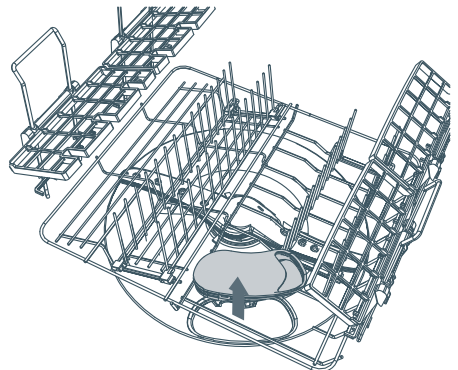
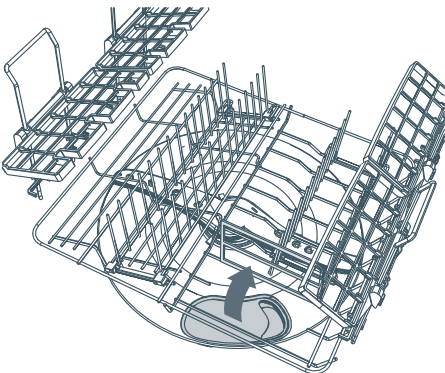

Cleaning the spray arm and filter plate

Ensure the DishDrawer® is cool before you start cleaning and follow the instructions for removing the drain filter and spray arm.

- 1 Unplug the DishDrawer® or turn it off at the power supply.
- 2 Unclip the glass supports from the rack wires and fold all the adjustable racks away, so that they are upright and close to the top.
- 3 Remove the base rack carefully. Lift from the back end first to prevent knocking the detergent and rinse aid dispenser.
- 4 Lift the spray arm and shake any foreign material out.

Rinse the spray arm clean under running water and wipe with a damp cloth.

- 5 In the centre of the filter plate there are two rings. Hold the centre ring still and turn the outer ring anti-clockwise, about a 1/8 turn. This will release the filter plate.
- 6 Lift the filter plate out.

When cleaning the underside of the filter plate, take care handling the sharp outer edge to avoid the risk of cuts.

Remove any foreign material, wash in hot soapy water and rinse thoroughly in clean water. The heater plate can be wiped with a damp cloth.

- 7 Replace the filter plate so it lies flat in the base of the drawer ensuring the filter plate is fully locked into position with the centre ring.

Important!

To lock the filter plate into position, ensure the lines align with each other (c) and all three pin pairs firmly interlock (e). Refer to the diagram for the correct position.

The filter plate must not be able to move about freely.

- 8 Replace the spray arm back onto the impeller.
- 9 Replace the base rack, lowering its front edge into position first.
- 10 Plug the DishDrawer® back in or turn it on at the power supply.

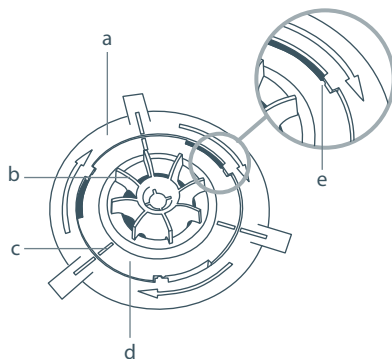
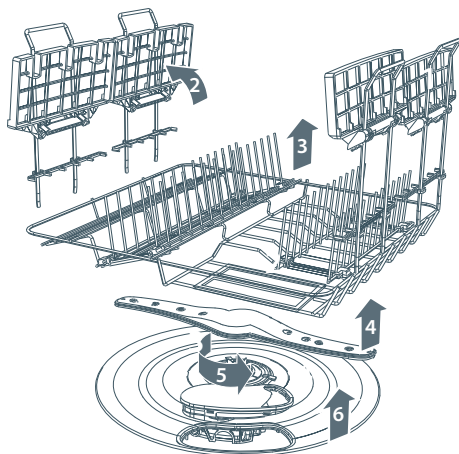





Correct locking position of filter plate with motor assembly (under spray arm)

- a Outer ring
- b Impeller
- c Correct alignment marks
- d Centre ring
- e Interlocking pins

Note: Where there is broken crockery or glass in the drawer, it must be carefully removed to prevent damage to the DishDrawer®.

Problem	Possible cause	What to do
Unclean dishes	Wash programme unsuitable for the load.	Refer to the 'Wash programme chart' for a suitable wash programme, or the soils were too heavily baked on and dishes may need soaking.
	Spray arm unable to rotate.	Ensure no items are obstructing the spray arm path.
	DishDrawer® overloaded/incorrectly loaded.	Refer to the section on loading.
	Filter plate/drain filter is incorrectly inserted.	Refer to the 'Care and cleaning' section.
	Detergent put in the wrong compartment.	Detergent must be placed in the large compartment.
	Excess food not removed from dinnerware prior to loading.	Scrape all food scraps off dinnerware prior to loading.
	Unsuitable detergent.	Use recommended brands of dishwasher detergent.
	Not enough detergent.	Refer to the detergent section or the detergent manufacturer's instructions.
	Spray arm holes are blocked.	Clean the spray arm.
Foaming	Incorrect amount of detergent.	Refer to the detergent section or consult the detergent manufacturer's instructions.
	Too much egg in the wash load.	Increase the amount of detergent.
	Rinse aid setting too high.	Decrease the rinse aid setting.
Water leaking	Drain hose disconnected from waste pipe.	Reconnect the drain hose to the waste pipe.
	Water inlet hose not properly connected.	Ensure the inlet hose is connected securely.
	Other leaks.	Turn water and power supplies to the DishDrawer® off. Call your dealer or Authorised Service Centre.
DishDrawer® will not open	Childlock feature is on or the Closed drawer option is on, or both.	Turn the Childlock off. Hold down the  button until the  symbol disappears from the LCD screen or the light above the  button disappears and/or press the  button to open the DishDrawer®.
Power failure during cycle		Wait until power resumes, cycle will restart in same part of wash programme.



Problem	Possible Cause	What to do
Continuous beeping	A fault has occurred.	Refer to the 'Fault codes' section.
Intermittent beeping	DishDrawer® is in pause mode.	Close the DishDrawer® and press the ►► button.
DishDrawer® will not start	Power supply is not connected.	Connect the power supply.
	The drawer is not closed properly.	Ensure the drawer is firmly closed.
	Keylock or Childlock feature is on.	Turn the Keylock or Childlock off. Hold down the  /  button until the  symbol disappears from the LCD screen or the light above the  /  button disappears.
	►► button not pressed.	Press the ►► button.
Excess water in the DishDrawer®	Drain hose(s) bent or kinked.	Straighten the drain hose(s).
	Blocked filters.	Clean the filter plate/drain filter. Refer to the 'Care and cleaning' section.
Water marks on the dishes	Rinse aid depleted.	Refill the rinse aid dispenser.
	Rinse aid setting too low.	Increase the rinse aid setting.
	DishDrawer® overloaded/incorrectly loaded.	Refer to the section on loading.
DishDrawer® interior is stained	Some foods, like tomato based products, may stain the inside of the DishDrawer®.	Pre-rinse dishes before placing in the DishDrawer®. Alternatively, using the Rinse programme after adding the dishes may minimise staining.
Dishes did not dry	Incorrect loading.	Ensure the dishes are not nesting together.
	Rinse aid depleted.	Refill the rinse aid dispenser.
	Rinse aid setting too low.	Increase the rinse aid setting.
	Eco wash programme used.	Choose a standard wash programme.
No detergent dispensed	Detergent dispenser was wet when loaded.	Clean the dispenser and ensure the dispenser is dry when adding detergent.
Excessive motor noise	The filter plate and/or spray arm is incorrectly placed.	Refer to the 'Care and cleaning' section for details on correct placement.
	No water in the motor area.	This usually occurs on the first use or when the DishDrawer® has not been used for long periods of time. Run the DishDrawer® through a wash programme.





How to recognise a fault code



















When a fault has occurred, the DishDrawer® will continuously beep every second.



The fault code will be displayed on the electronic display for models with LCD and on the wash programme selector for models with no LCD.

Each fault code is shown in the following chart.

How to attend to a fault code

- 1 Press the  button to remove the fault code.
- 2 If the fault code and continuous beeps cannot be removed by pressing the  button, turn the DishDrawer® off at the power supply.
- 3 We recommend you check the following chart and correct the fault where possible.
- 4 After attending to the fault, turn the DishDrawer® on at the power supply.
- 5 If the fault code and continuous beeps remain, turn the water and power supply off to the DishDrawer®.
- 6 When calling your Authorised Service Centre, advise them of the fault code that has appeared on the DishDrawer®. This information will help the Authorised Service Centre respond to your request.

Fault codes	Possible causes	What to do
<p>F1 </p> 	Flood switch has been activated.	Turn the water and power supply to the DishDrawer® off and call your Authorised Service Centre or Customer Care.
<p>F2 </p> 	Motor problem.	Call your Authorised Service Centre or Customer Care.
<p>F3 </p> 	Temperature sensor failed.	Ensure water coming in through the inlet hose is less than 65 °C. You may need to install a tempering valve on your water supply.
<p>F4 </p> 	Faulty temperature sensor or element.	Call your Authorised Service Centre or Customer Care.
<p>F5 </p> 	Lid fault.	<ol style="list-style-type: none"> 1 Turn power supply to DishDrawer® off, then turn on power supply. Fault may reset. 2 Call your Authorised Service Centre or Customer Care.
<p>F6 </p> 	Lid fault.	<ol style="list-style-type: none"> 1 Turn power supply to DishDrawer® off, then turn on power supply. Fault may reset. 2 Call your Authorised Service Centre or Customer Care.
<p>F7 </p> 	Lid fault.	Call your Authorised Service Centre or Customer Care.
<p>F8 </p> 	Electrical problem.	<ol style="list-style-type: none"> 1 Turn power supply to DishDrawer® off. 2 Call your Authorised Service Centre or Customer Care.
<p>F9 </p> 	Electronics malfunction.	Call your Authorised Service Centre or Customer Care.

Fault codes	Possible causes	What to do
<p>U1 </p> 	<p>Fill fault.</p>	<ol style="list-style-type: none"> 1 Turn the DishDrawer® water supply on. 2 Ensure the spray arm is placed on the impeller and can rotate about the centre. If the DishDrawer® is full of water, it will need to be emptied manually. 3 Call your Authorised Service Centre or Customer Care.
<p>U4 U4</p> 	<p>Fault in the other drawer preventing the use of this drawer.</p>	<p>Check other drawer, attend to fault code on that drawer.</p>



Before you call for service or assistance ...

Check the things you can do yourself. Refer to the installation instructions and your user guide and check that:

- 1 your product is correctly installed
- 2 you are familiar with its normal operation.

If after checking these points you still need assistance, please refer to the Service & Warranty book for warranty details and your nearest Authorised Service Centre, or contact us through our website listed on the back cover.



Copyright © Fisher & Paykel 2009. All rights reserved.

The product specifications in this booklet apply to the specific products and models described at the date of issue. Under our policy of continuous product improvement, these specifications may change at any time. You should therefore check with your Dealer to ensure this booklet correctly describes the product currently available.

www.fisherpaykel.co.nz
www.fisherpaykel.com.au

NZ AU
DishDrawer® user guide
Published: 02/2009
Part No. 599732 A