

VEVOR[®]

TOUGH TOOLS, HALF PRICE

Technical Support and E-Warranty Certificate www.vevor.com/support

CLIMB TUNNEL

MODEL:LY-1602

We continue to be committed to provide you tools with competitive price.

"Save Half", "Half Price" or any other similar expressions used by us only represents an estimate of savings you might benefit from buying certain tools with us compared to the major top brands and dose not necessarily mean to cover all categories of tools offered by us. You are kindly reminded to verify carefully when you are placing an order with us if you are actually saving half in comparison with the top major brands.

VEVOR[®]

TOUGH TOOLS, HALF PRICE

CLIMB TUNNEL

MODEL:LY-1602

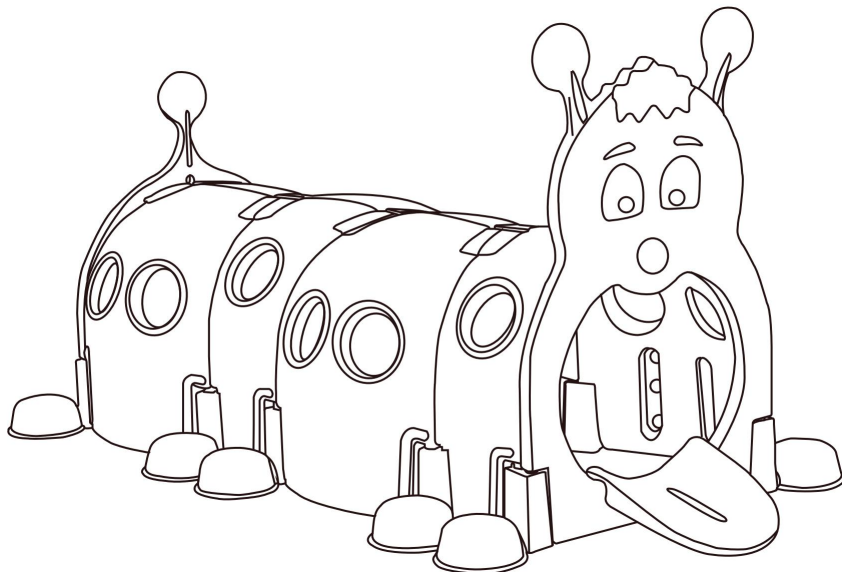

NEED HELP? CONTACT US!

Have product questions? Need technical support? Please feel free to contact us:

Technical Support and E-Warranty Certificate
www.vevor.com/support

This is the original instruction, please read all manual instructions carefully before operating. VEVOR reserves a clear interpretation of our user manual. The appearance of the product shall be subject to the product you received. Please forgive us that we won't inform you again if there are any technology or software updates on our product.



Warning-To reduce the risk of injury, user must read instructions manual carefully.

With multiple shapes, you create an unlimited combination of structures. Your baby can develop its gross motor skills by playing with these blocks. Very soft and dense. Each block comes with tightly sewn seams to prevent tears.

No hard surfaces or sharp corners that can hurt your little one while playing.

Lightweight and stackable, let them stack and stimulate their creativity. Makes good exercise.

The blocks are waterproof, so cleaning them up is a breeze. Simply wipe away any dirt.

Create little obstacle courses to make things challenging and fun for your babies.

Recommended to be used under the direct supervision of an adult.

Product Introduction

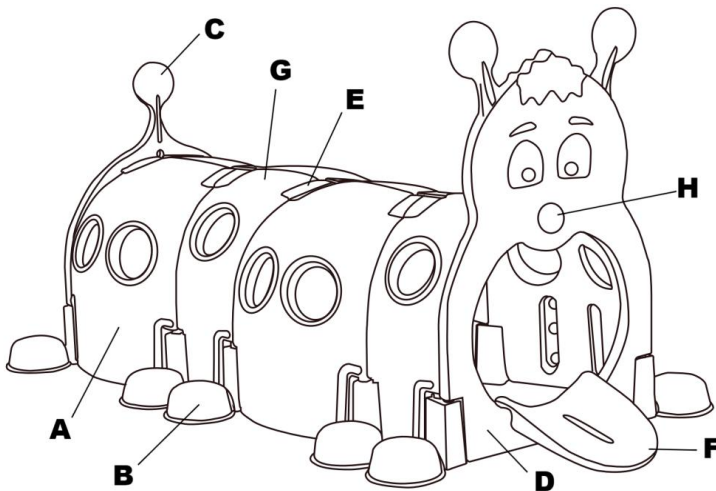

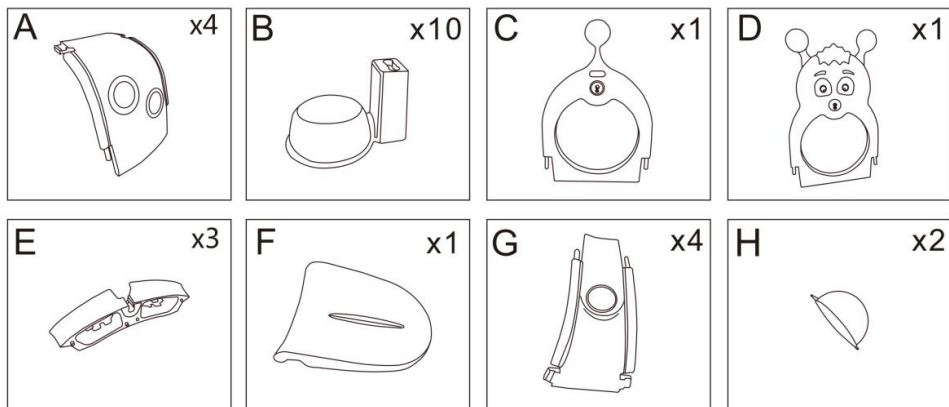

Installation Procedure

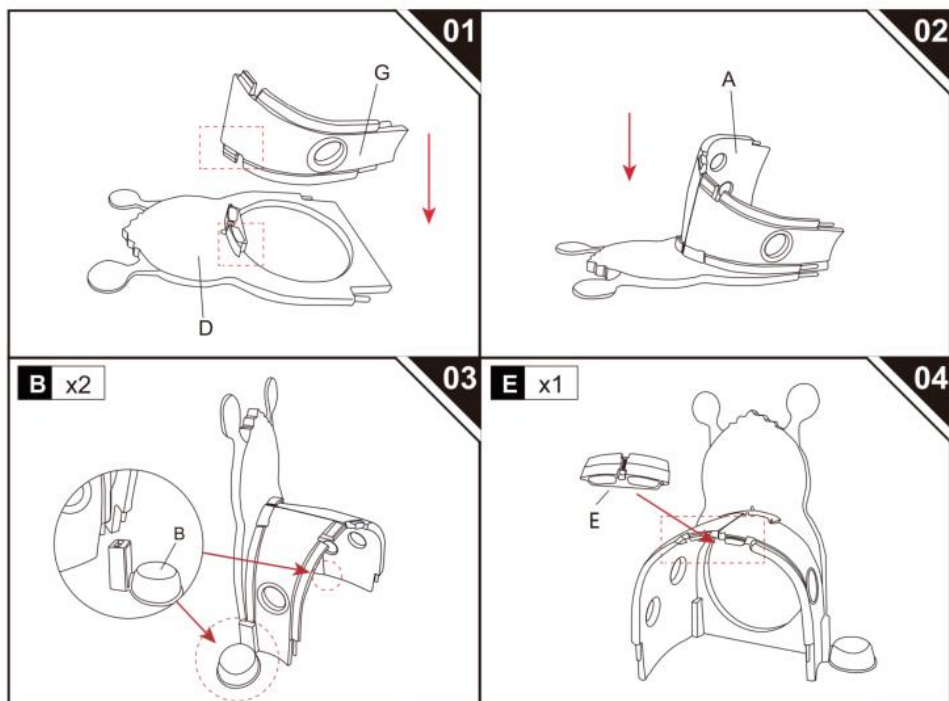

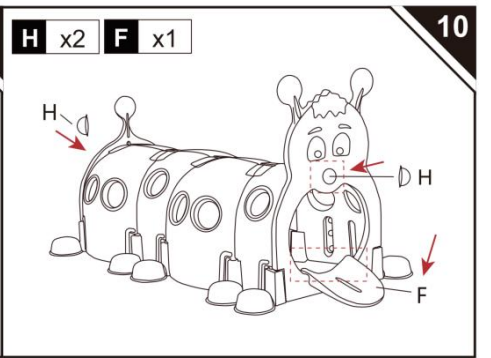
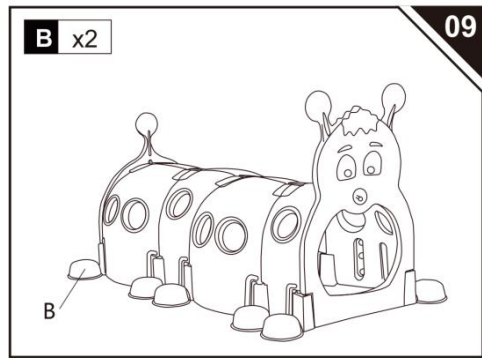
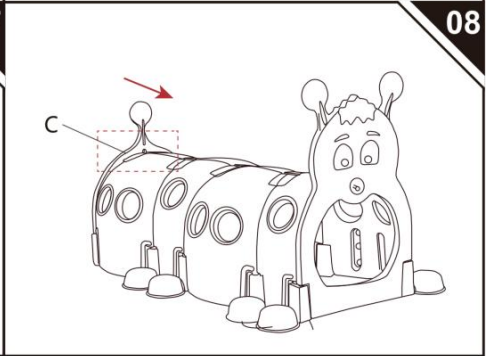
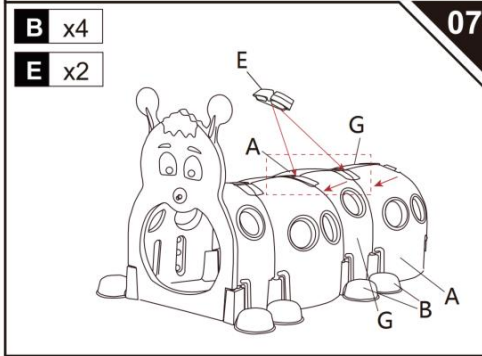
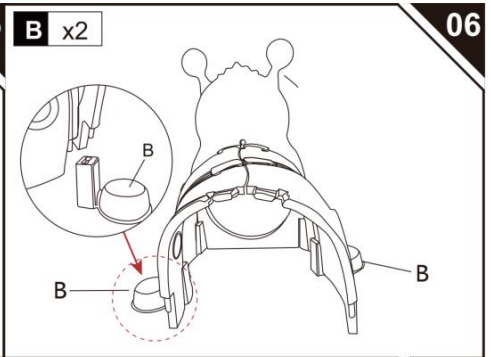
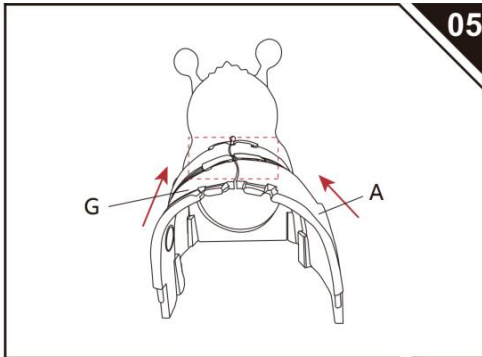



Address: Baoshanqu Shuangchenglu 803long 11hao 1602A-1609shi
Shanghai

Imported to AUS: SIHAO PTY LTD.1 ROKEVA STREETEASTWOOD
NSW 2122 Australia

Imported to USA: Sanven Technology Ltd. Suite 250, 9166 Anaheim
Place, Rancho Cucamonga, CA 91730



Pooledas Group Ltd
Unit 5 Albert Edward House, The Pavilions
Preston, United Kingdom



SHUNSHUN GmbH
Römeräcker 9 Z2021, 76351
Linkenheim-Hochstetten, Germany

Made In China

VEVOR[®]

TOUGH TOOLS, HALF PRICE

Technical Support and E-Warranty Certificate

www.vevor.com/support

VEVOR[®]

TOUGH TOOLS, HALF PRICE

Technique Assistance et certificat de garantie électronique

www.vevor.com/support

TUNNEL DE MONTÉE

MODÈLE : LY-1602

We continue to be committed to provide you tools with competitive price.

"Save Half", "Half Price" or any other similar expressions used by us only represents an estimate of savings you might benefit from buying certain tools with us compared to the major top brands and dose not necessarily mean to cover all categories of tools offered by us. You are kindly reminded to verify carefully when you are placing an order with us if you are actually saving half in comparison with the top major brands.

VEVOR[®]

TOUGH TOOLS, HALF PRICE

CLIMB TUNNEL

MODÈLE : LY-1602

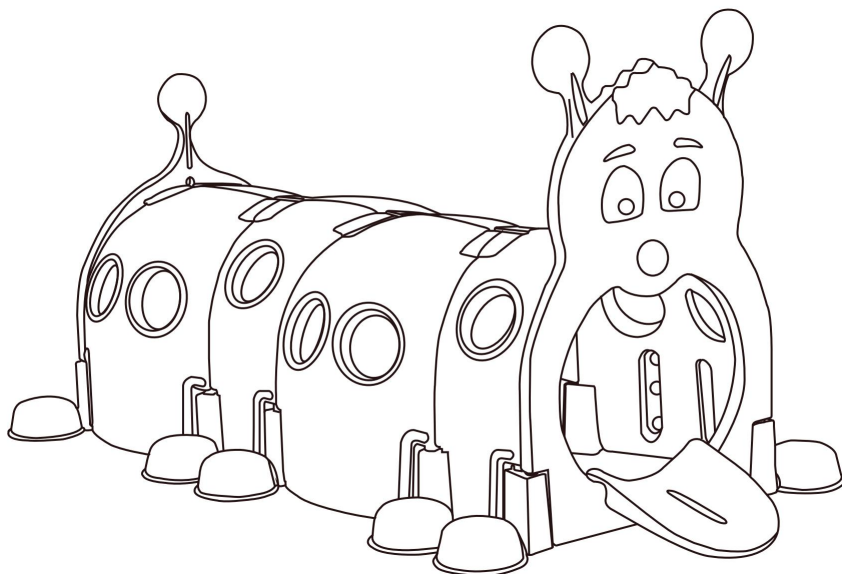

NEED HELP? CONTACT US!

Have product questions? Need technical support? Please feel free to contact us:

Technical Support and E-Warranty Certificate
www.vevor.com/support

This is the original instruction, please read all manual instructions carefully before operating. VEVOR reserves a clear interpretation of our user manual. The appearance of the product shall be subject to the product you received. Please forgive us that we won't inform you again if there are any technology or software updates on our product.



Avertissement : Pour réduire le risque de blessure, l'utilisateur doit lire attentivement le manuel d'instructions.

Avec plusieurs formes, vous créez une combinaison illimitée de structures. Votre bébé peut développer sa motricité globale en jouant avec ces blocs. Très doux et dense. Chaque bloc est doté de coutures étroitement cousues pour éviter les déchirures.

Pas de surfaces dures ni de coins pointus qui pourraient blesser votre tout-petit en jouant.

Légers et empilables, laissez-les s'empiler et stimuler leur créativité. Fait un bon exercice.

Les blocs sont étanches, leur nettoyage est donc un jeu d'enfant. Essuyez simplement toute saleté.

Créez de petits parcours d'obstacles pour rendre les choses difficiles et amusantes pour vos bébés.

Il est recommandé de l'utiliser sous la surveillance directe d'un adulte.

Présentation du produit

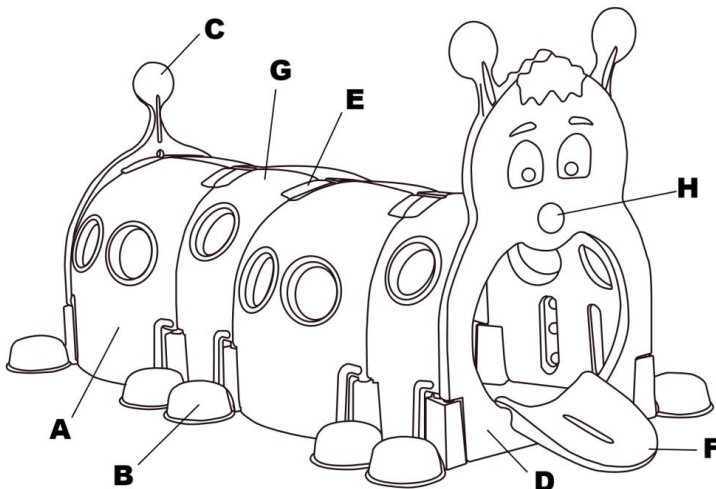

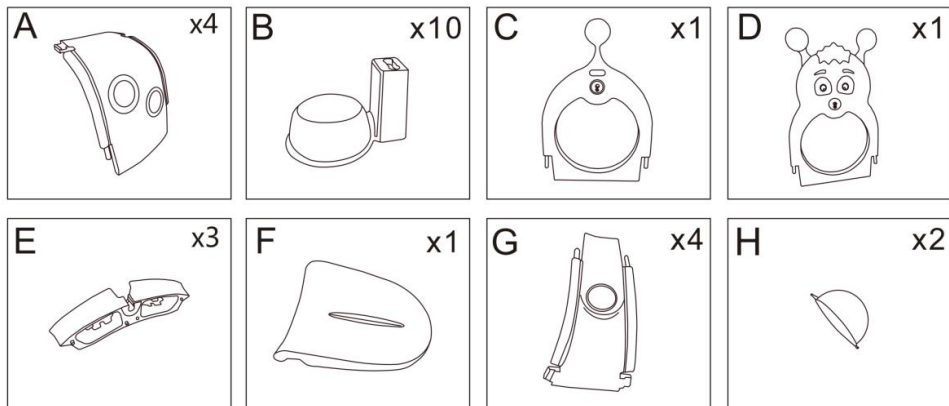

Procédure d'installation

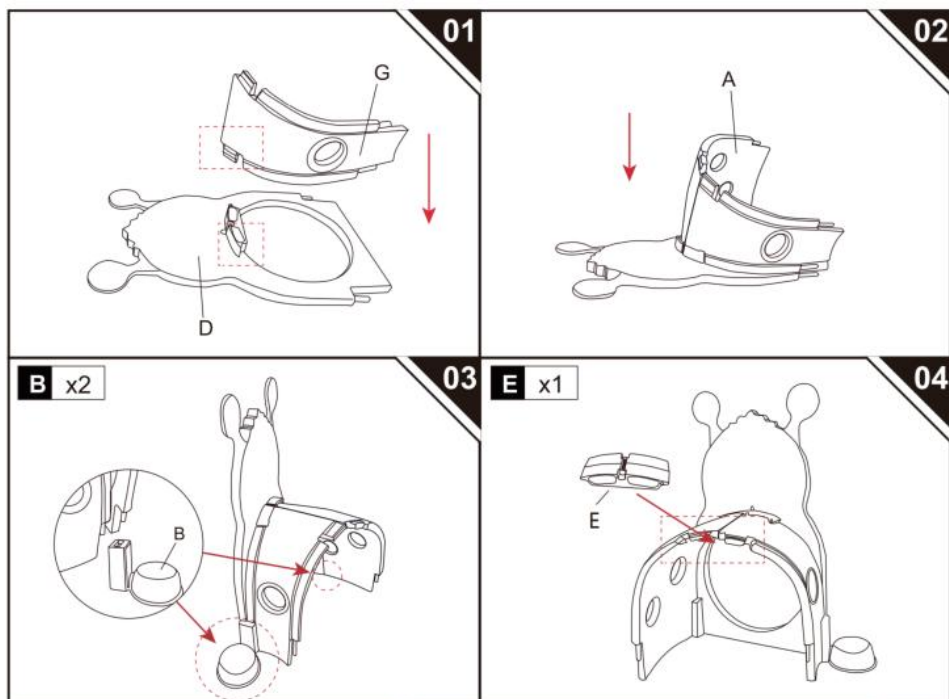

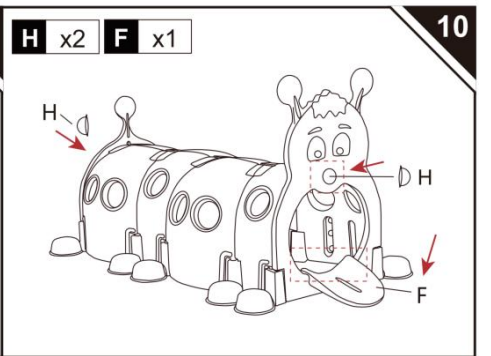
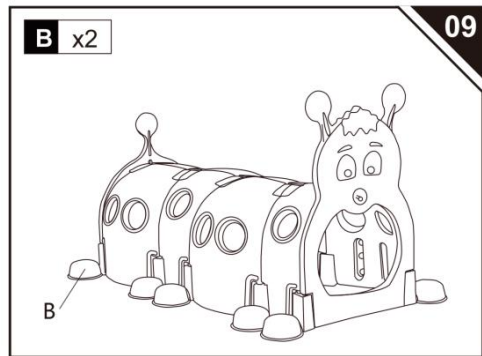
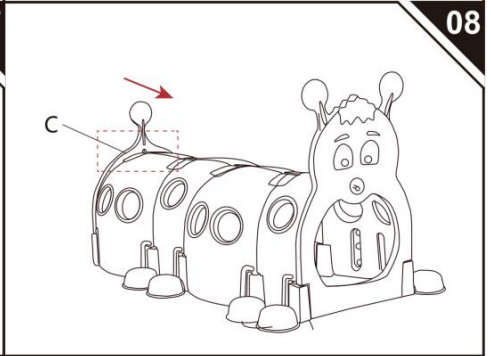
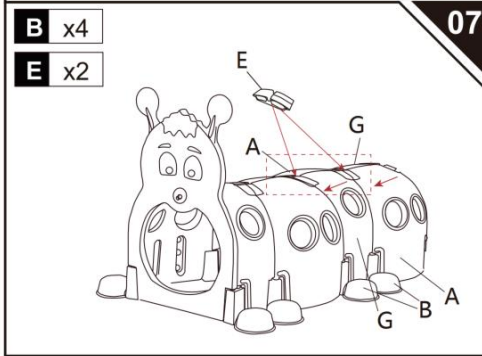
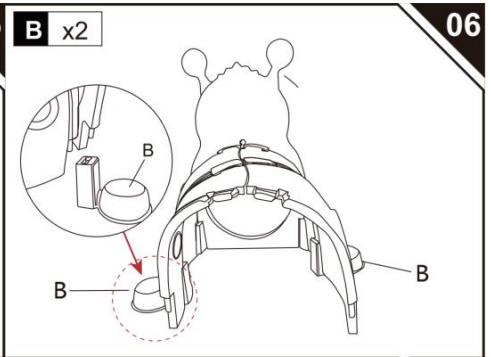
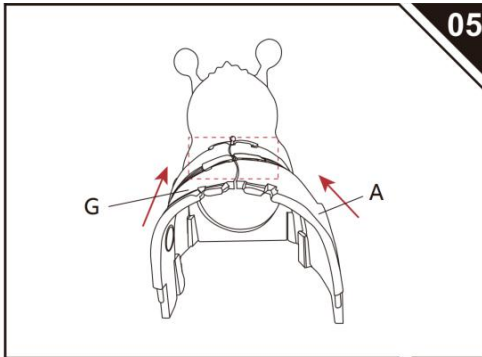



Adresse : Baoshanqu Shuangchenglu 803long 11hao 1602A-1609shi
Shanghai

Importé en Australie : SIHAO PTY LTD . 1 ROKEVA STREETASTWOOD
NSW 2122 Australie

Importé aux États-Unis : Sanven Technology Ltd. Bureau 250, 9166
Anaheim Place, Rancho Cucamonga, CA 91730



Pooledas Group Ltd
Unit 5 Albert Edward House, The Pavilions
Preston, United Kingdom



SHUNSHUN GmbH
Römeräcker 9 Z2021, 76351
Linkenheim-Hochstetten, Germany

Fabriqué en Chine

VEVOR[®]

TOUGH TOOLS, HALF PRICE

Technique Assistance et certificat de garantie électronique

www.vevor.com/support

VEVOR[®]

TOUGH TOOLS, HALF PRICE

Technisch Support- und E-Garantie-Zertifikat www.vevor.com/support

KLETTERTUNNEL

MODELL: LY-1602

We continue to be committed to provide you tools with competitive price.

"Save Half", "Half Price" or any other similar expressions used by us only represents an estimate of savings you might benefit from buying certain tools with us compared to the major top brands and dose not necessarily mean to cover all categories of tools offered by us. You are kindly reminded to verify carefully when you are placing an order with us if you are actually saving half in comparison with the top major brands.

VEVOR®

TOUGH TOOLS, HALF PRICE

CLIMB TUNNEL

MODELL: LY-1602

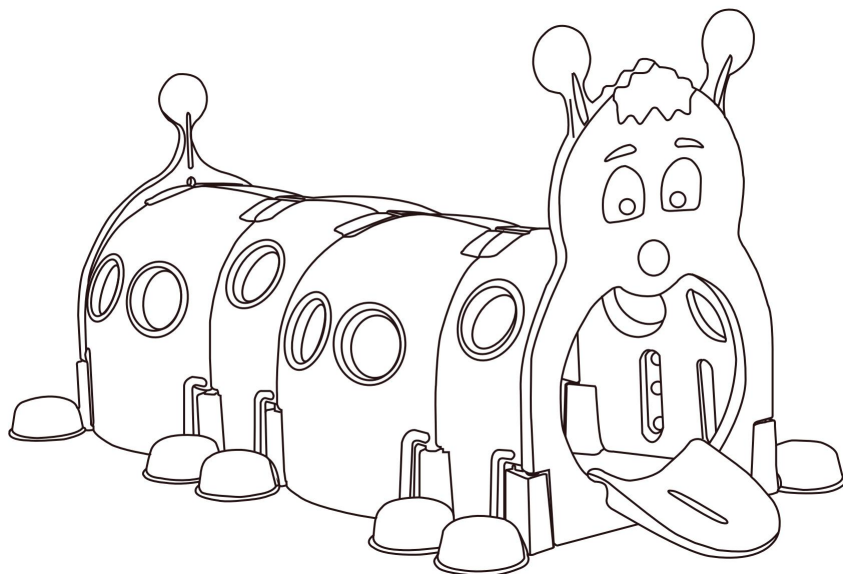

NEED HELP? CONTACT US!

Have product questions? Need technical support? Please feel free to contact us:

Technical Support and E-Warranty Certificate
www.vevor.com/support

This is the original instruction, please read all manual instructions carefully before operating. VEVOR reserves a clear interpretation of our user manual. The appearance of the product shall be subject to the product you received. Please forgive us that we won't inform you again if there are any technology or software updates on our product.



Warnung: Um das Verletzungsrisiko zu verringern, muss der Benutzer die Bedienungsanleitung sorgfältig lesen.

Mit mehreren Formen schaffen Sie eine unbegrenzte Kombination von Strukturen.

Durch das Spielen mit diesen Blöcken kann Ihr Baby seine grobmotorischen Fähigkeiten entwickeln.

Sehr weich und dicht. Jeder Block ist mit fest vernähten Nähten versehen, um Risse zu verhindern.

Keine harten Oberflächen oder scharfen Ecken, die Ihren Kleinen beim Spielen verletzen könnten.

Leicht und stapelbar, lassen Sie sie stapeln und ihre Kreativität anregen. Macht gute Übungen.

Die Blöcke sind wasserdicht, sodass die Reinigung ein Kinderspiel ist. Schmutz einfach abwischen.

Erstellen Sie kleine Hindernisparcours, um die Dinge für Ihre Babys herausfordernd und unterhaltsam zu gestalten.

Es wird empfohlen, es unter direkter Aufsicht eines Erwachsenen zu verwenden.

Produkteinführung _ _

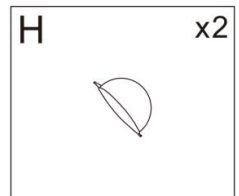
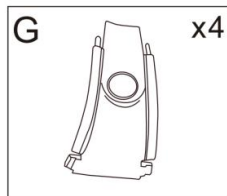
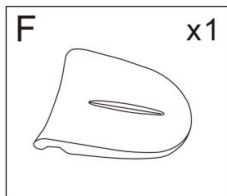
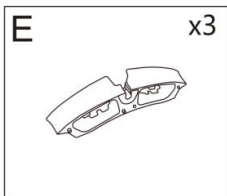
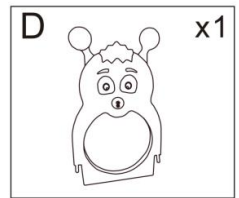
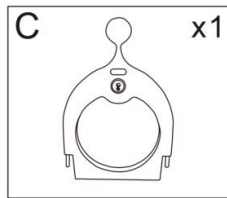
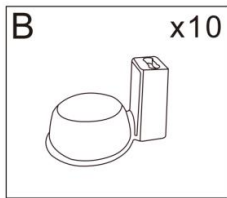
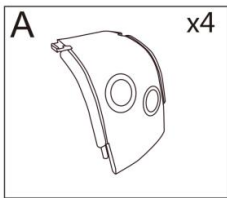
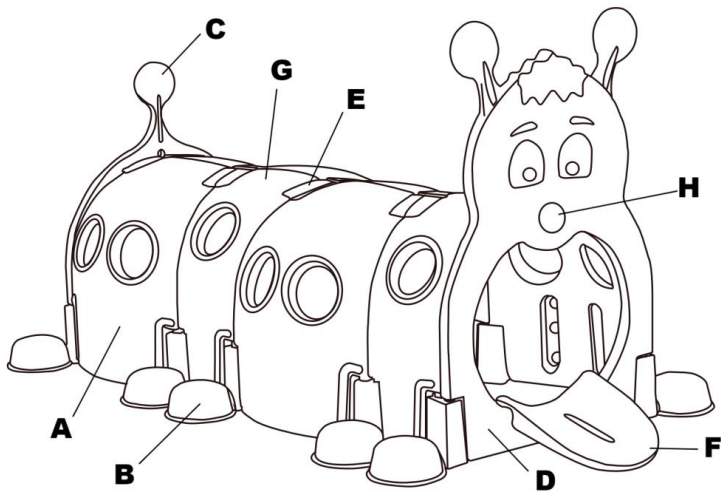

Installationsvorgang __

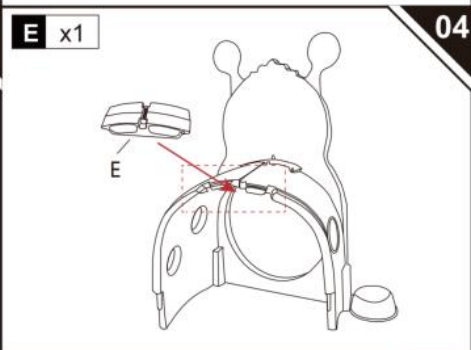
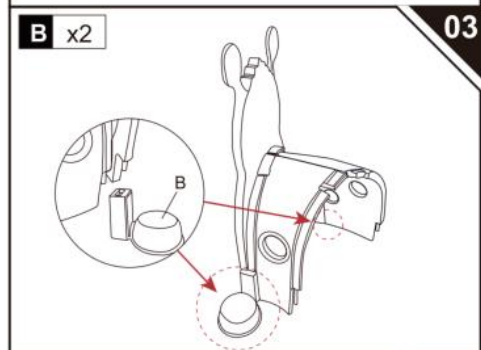
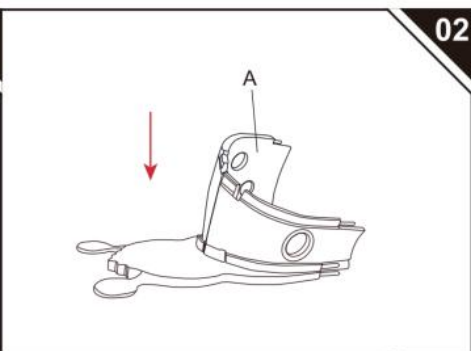
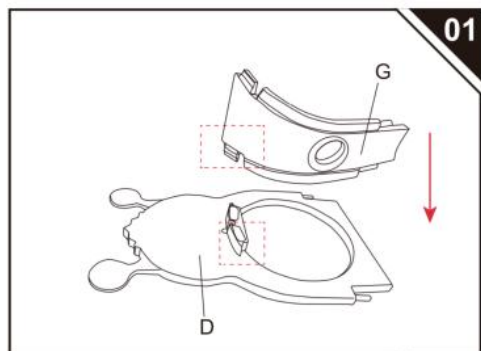

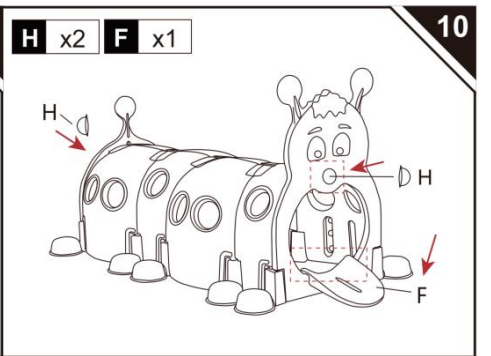
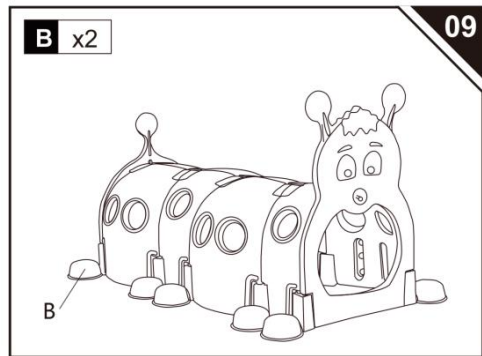
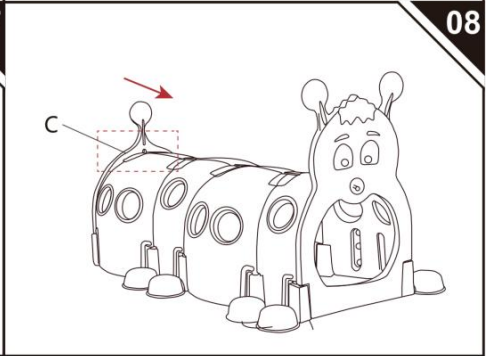
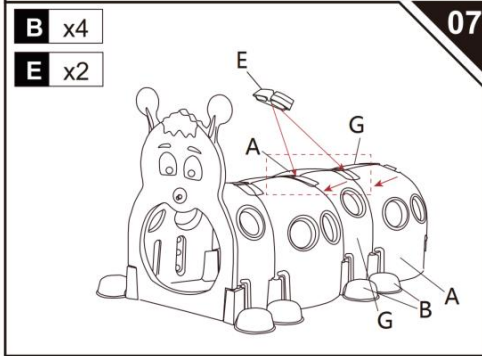
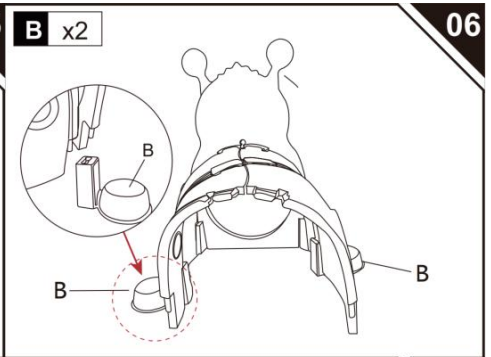
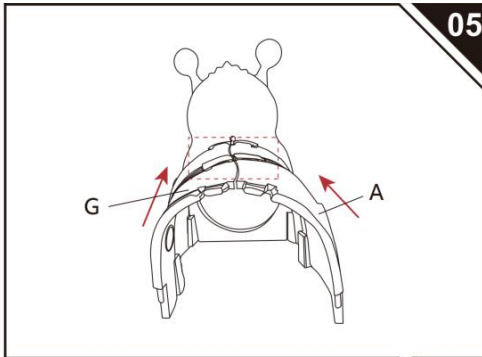



Adresse: Baoshanqu Shuangchenglu 803long 11hao 1602A-1609shi
Shanghai

Importiert nach AUS: SIHAO PTY LTD . 1 ROKEVA
STREETEASTWOOD NSW 2122 Australien

Importiert in die USA: Sanven Technology Ltd. Suite 250, 9166 Anaheim
Place, Rancho Cucamonga, CA 91730



Pooledas Group Ltd
Unit 5 Albert Edward House, The Pavilions
Preston, United Kingdom



SHUNSHUN GmbH
Römeräcker 9 Z2021, 76351
Linkenheim-Hochstetten, Germany

In China hergestellt

VEVOR[®]

TOUGH TOOLS, HALF PRICE

Technisch Support- und E-Garantiezertifikat

www.vevor.com/support

VEVOR[®]

TOUGH TOOLS, HALF PRICE

Tecnico Supporto e certificato di garanzia elettronica www.vevor.com/support

TUNNEL DI SALITA

MODELLO: LY-1602

We continue to be committed to provide you tools with competitive price.

"Save Half", "Half Price" or any other similar expressions used by us only represents an estimate of savings you might benefit from buying certain tools with us compared to the major top brands and dose not necessarily mean to cover all categories of tools offered by us. You are kindly reminded to verify carefully when you are placing an order with us if you are actually saving half in comparison with the top major brands.

VEVOR[®]

TOUGH TOOLS, HALF PRICE

CLIMB TUNNEL

MODELLO: LY-1602

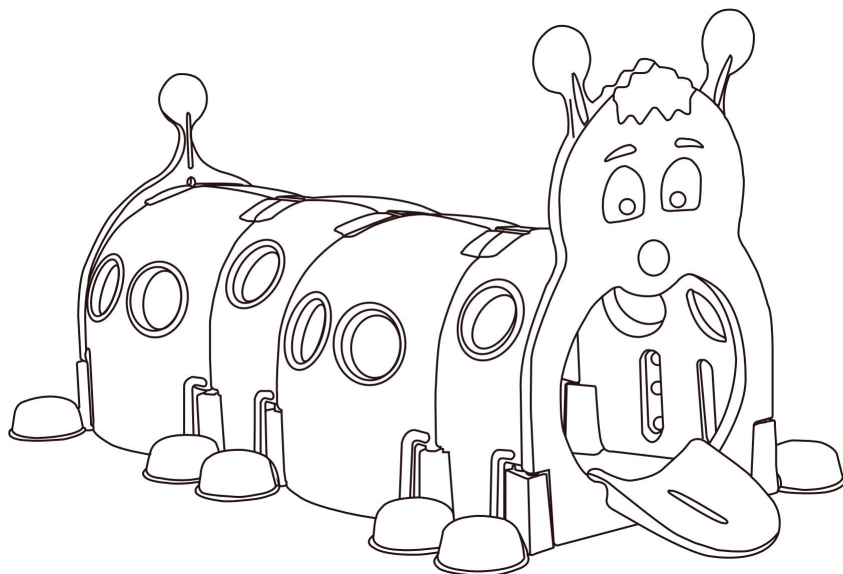

NEED HELP? CONTACT US!

Have product questions? Need technical support? Please feel free to contact us:

Technical Support and E-Warranty Certificate
www.vevor.com/support

This is the original instruction, please read all manual instructions carefully before operating. VEVOR reserves a clear interpretation of our user manual. The appearance of the product shall be subject to the product you received. Please forgive us that we won't inform you again if there are any technology or software updates on our product.



Avvertenza: per ridurre il rischio di lesioni, l'utente deve leggere attentamente il manuale di istruzioni.

Con più forme, crei una combinazione illimitata di strutture.

Il tuo bambino può sviluppare le sue capacità motorie generali giocando con questi blocchi.

Molto morbido e denso. Ogni blocco è dotato di cuciture ben cucite per evitare strappi.

Nessuna superficie dura o spigolo vivo che possa ferire il tuo piccolo mentre gioca.

Leggeri e impilabili, lasciali impilare e stimola la loro creatività. Fa un buon esercizio.

I blocchi sono impermeabili, quindi pulirli è un gioco da ragazzi. Basta semplicemente rimuovere lo sporco.

Crea piccoli percorsi a ostacoli per rendere le cose stimolanti e divertenti per i tuoi bambini.

Consigliato per l'uso sotto la diretta supervisione di un adulto.

Introduzione al prodotto

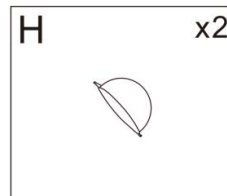
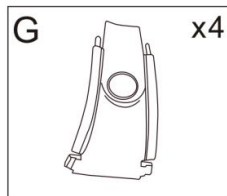
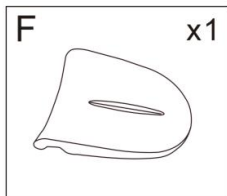
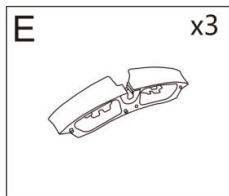
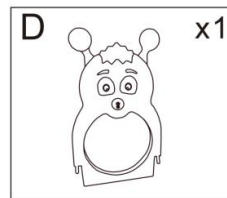
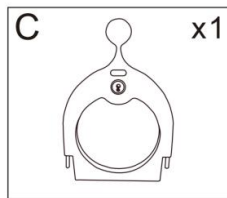
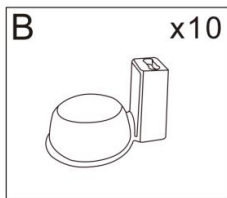
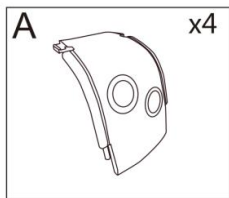
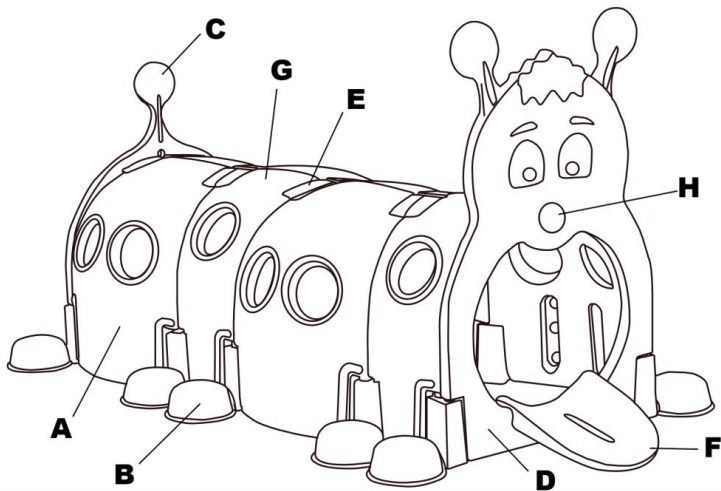

Procedura d' installazione

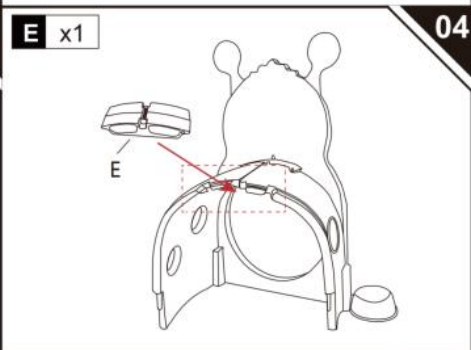
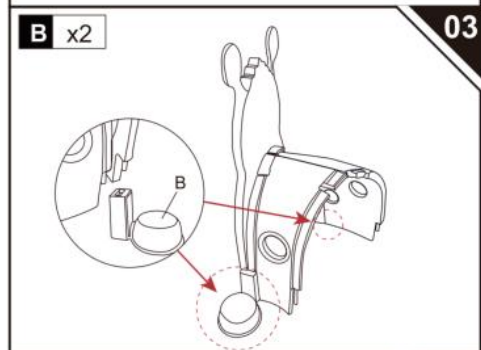
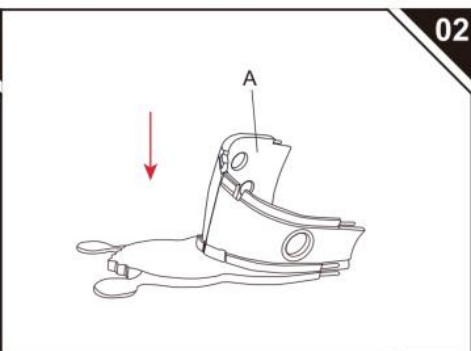
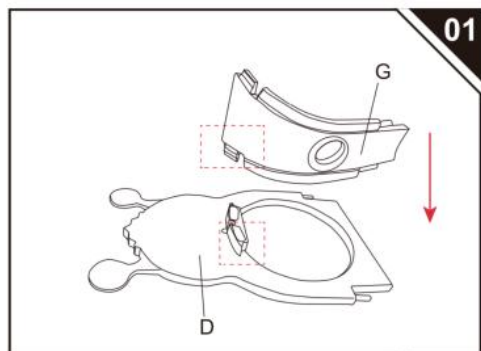

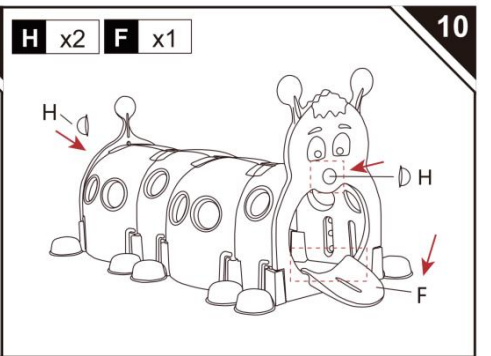
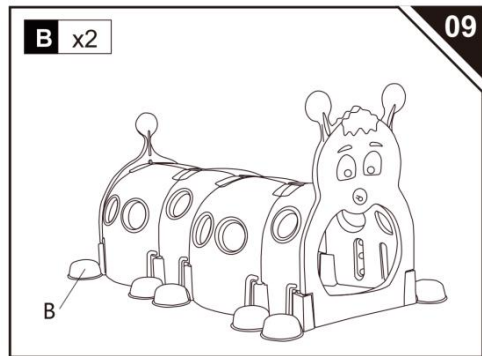
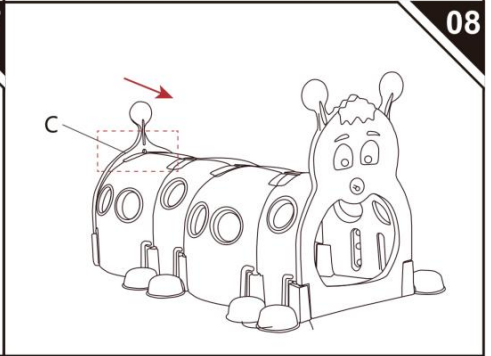
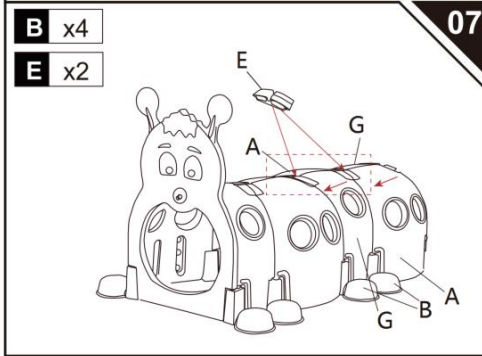
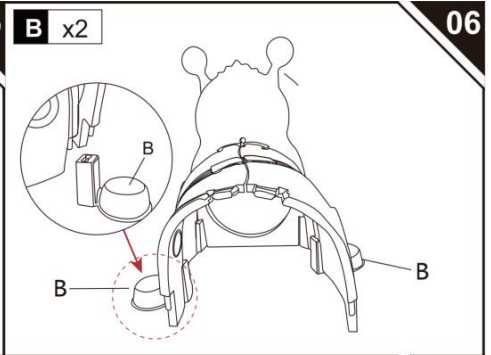
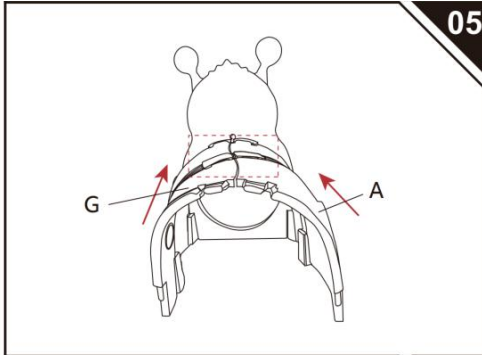



Indirizzo: Baoshanqu Shuangchenglu 803long 11hao 1602A-1609shi
Shanghai

Importato in AUS: SIHAO PTY LTD . 1 ROKEVA STREETEASTWOOD
NSW 2122 Australia

Importato negli Stati Uniti: Sanven Technology Ltd. Suite 250, 9166
Anaheim Place, Rancho Cucamonga, CA 91730



Pooledas Group Ltd
Unit 5 Albert Edward House, The Pavilions
Preston, United Kingdom



SHUNSHUN GmbH
Römeräcker 9 Z2021, 76351
Linkenheim-Hochstetten, Germany

Made in China

VEVOR[®]

TOUGH TOOLS, HALF PRICE

Tecnico Supporto e certificato di garanzia elettronica

www.vevor.com/support

VEVOR[®]

TOUGH TOOLS, HALF PRICE

Técnico Soporte y certificado de garantía electrónica www.vevor.com/support

SUBIR TÚNEL

MODELO: LY-1602

We continue to be committed to provide you tools with competitive price.

"Save Half", "Half Price" or any other similar expressions used by us only represents an estimate of savings you might benefit from buying certain tools with us compared to the major top brands and dose not necessarily mean to cover all categories of tools offered by us. You are kindly reminded to verify carefully when you are placing an order with us if you are actually saving half in comparison with the top major brands.

VEVOR[®]

TOUGH TOOLS, HALF PRICE

CLIMB TUNNEL

MODELO: LY-1602

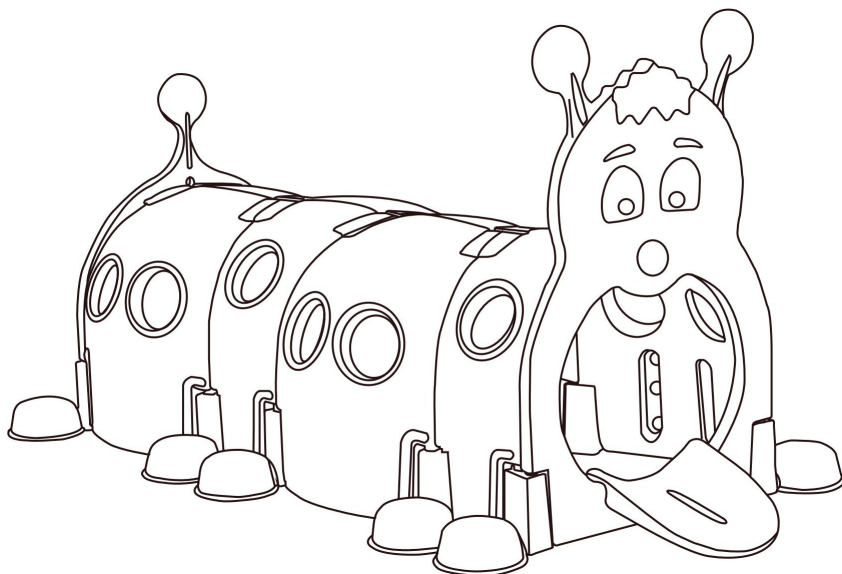

NEED HELP? CONTACT US!

Have product questions? Need technical support? Please feel free to contact us:

Technical Support and E-Warranty Certificate
www.vevor.com/support

This is the original instruction, please read all manual instructions carefully before operating. VEVOR reserves a clear interpretation of our user manual. The appearance of the product shall be subject to the product you received. Please forgive us that we won't inform you again if there are any technology or software updates on our product.



Advertencia: para reducir el riesgo de lesiones, el usuario debe leer atentamente el manual de instrucciones.

Con múltiples formas, creas una combinación ilimitada de estructuras.

Tu bebé podrá desarrollar su motricidad gruesa jugando con estos bloques.

Muy suave y denso. Cada bloque viene con costuras bien cosidas para evitar desgarros.

Sin superficies duras ni esquinas afiladas que puedan lastimar a tu pequeño mientras juega.

Ligeros y apilables, déjalos apilar y estimular su creatividad. Hace un buen ejercicio.

Los bloques son resistentes al agua, por lo que limpiarlos es muy sencillo. Simplemente limpie la suciedad.

Crea pequeñas pistas de obstáculos para que las cosas sean desafiantes y divertidas para tus bebés.

Recomendado para ser utilizado bajo la supervisión directa de un adulto.

Introducción del producto

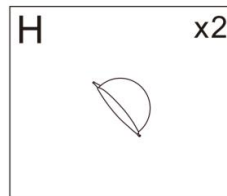
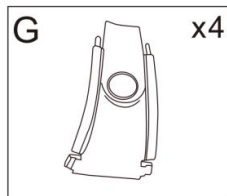
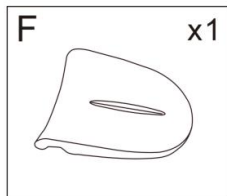
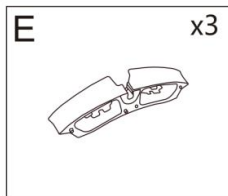
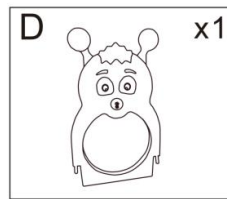
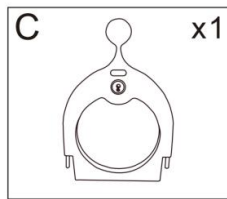
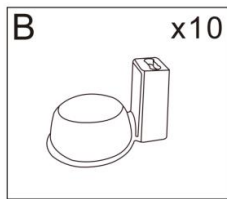
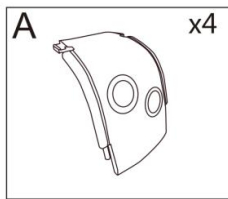
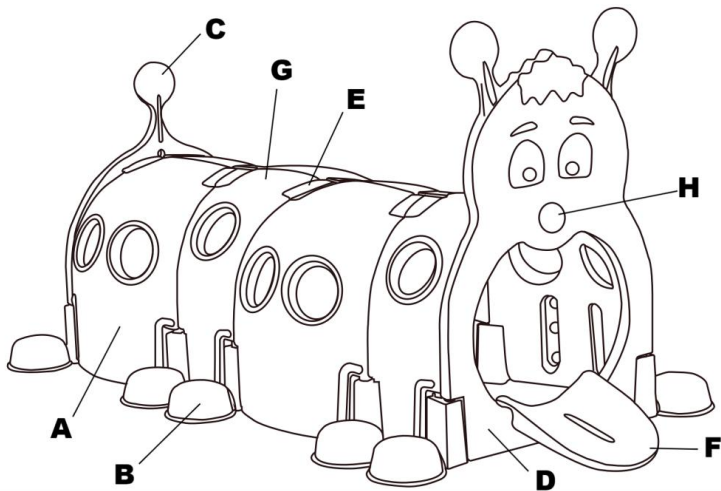

Procedimiento de instalación

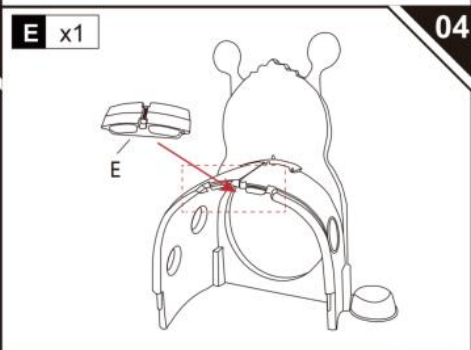
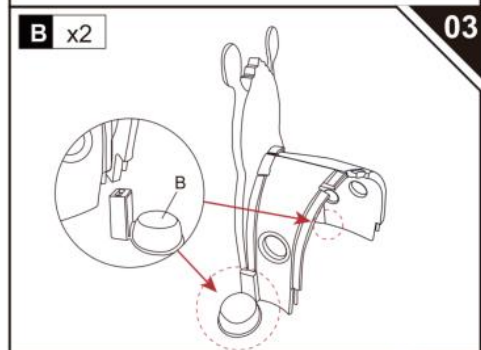
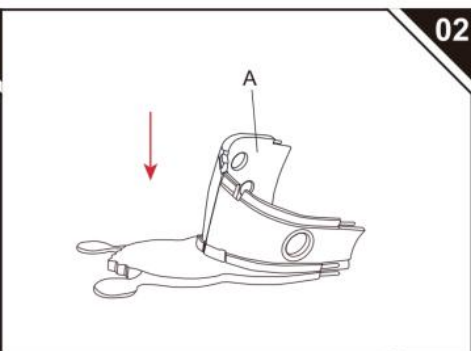
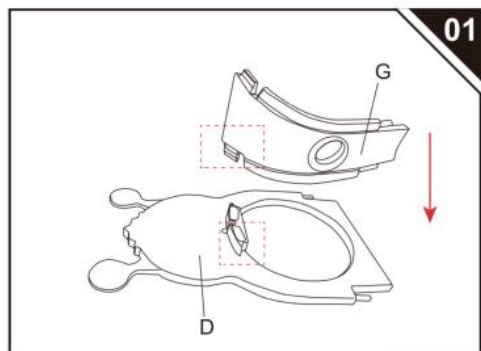

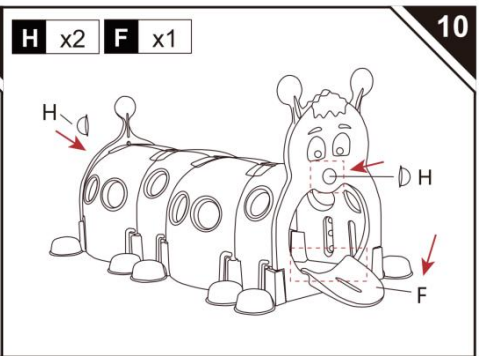
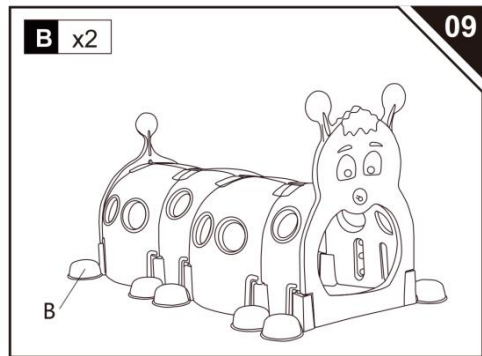
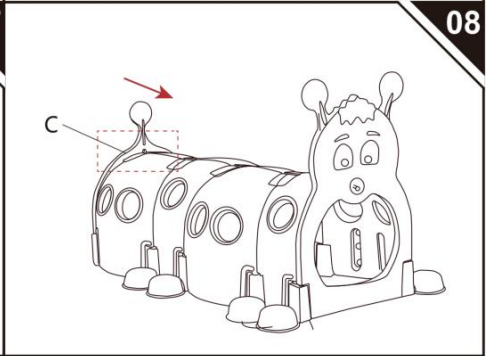
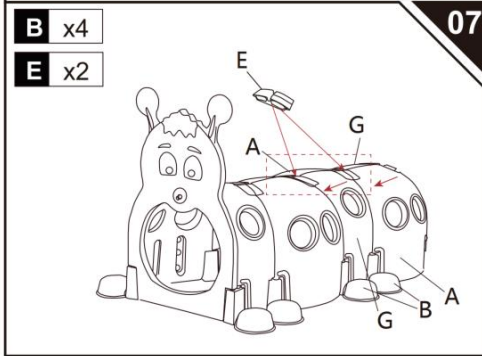
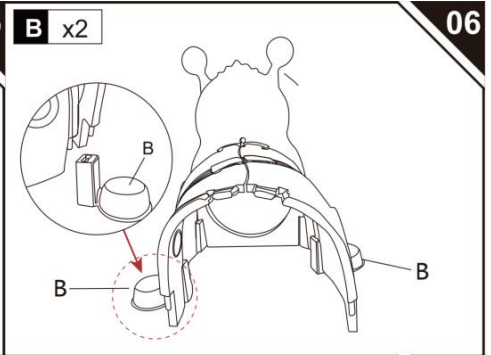
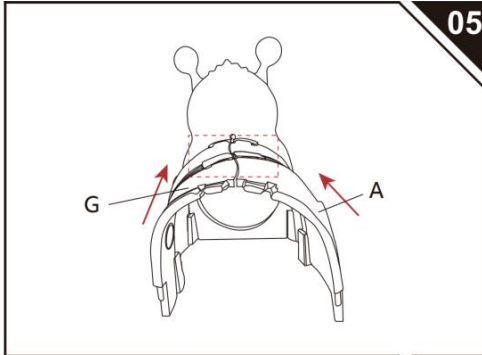



Dirección: Baoshanqu Shuangchenglu 803long 11hao 1602A-1609shi
Shanghai

Importado a AUS: SIHAO PTY LTD . 1 ROKEVA STREETASTWOOD
NSW 2122 Australia

Importado a EE. UU.: Sanven Technology Ltd. Suite 250, 9166 Anaheim
Place, Rancho Cucamonga, CA 91730



Pooledas Group Ltd
Unit 5 Albert Edward House, The Pavilions
Preston, United Kingdom



SHUNSHUN GmbH
Römeräcker 9 Z2021, 76351
Linkenheim-Hochstetten, Germany

Hecho en china

VEVOR[®]

TOUGH TOOLS, HALF PRICE

Técnico Certificado de soporte y garantía electrónica

www.vevor.com/support

VEVOR[®]

TOUGH TOOLS, HALF PRICE

Techniczny Certyfikat wsparcia i e-gwarancji www.vevor.com/support

TUNEL WSPINACZKOWY

MODEL: LY-1602

We continue to be committed to provide you tools with competitive price.

"Save Half", "Half Price" or any other similar expressions used by us only represents an estimate of savings you might benefit from buying certain tools with us compared to the major top brands and dose not necessarily mean to cover all categories of tools offered by us. You are kindly reminded to verify carefully when you are placing an order with us if you are actually saving half in comparison with the top major brands.

VEVOR[®]

TOUGH TOOLS, HALF PRICE

CLIMB TUNNEL

MODEL: LY-1602

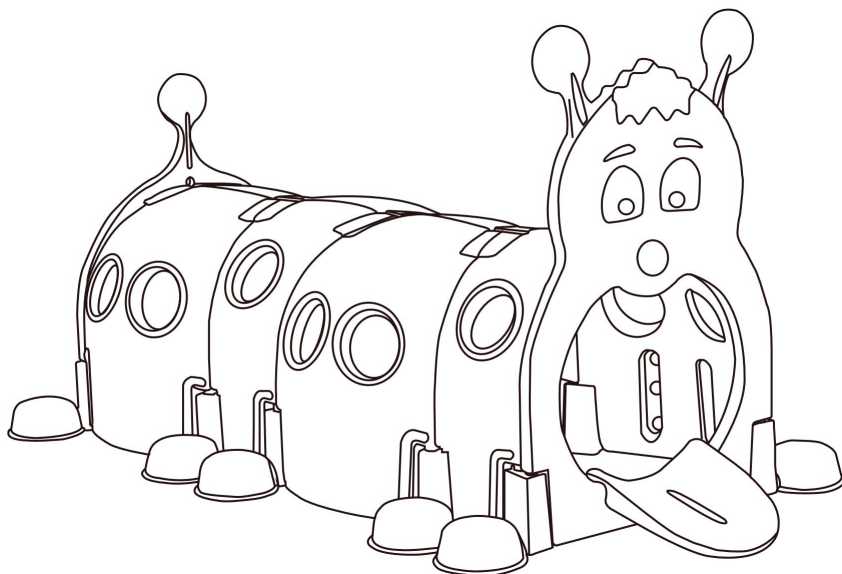

NEED HELP? CONTACT US!

Have product questions? Need technical support? Please feel free to contact us:

Technical Support and E-Warranty Certificate
www.vevor.com/support

This is the original instruction, please read all manual instructions carefully before operating. VEVOR reserves a clear interpretation of our user manual. The appearance of the product shall be subject to the product you received. Please forgive us that we won't inform you again if there are any technology or software updates on our product.



Ostrzeżenie — aby zmniejszyć ryzyko obrażeń, użytkownik musi uważnie przeczytać instrukcję obsługi.

Dzięki wielu kształtom tworzysz nieograniczoną kombinację struktur.

Bawąc się tymi klockami, Twoje dziecko może rozwijać swoje umiejętności motoryczne.

Bardzo miękkie i gęste. Każdy blok ma ściśle zszyte szwy, które zapobiegają rozdarciom.

Żadnych twardych powierzchni i ostrych narożników, które mogłyby zranić malucha podczas zabawy.

Lekkie i można je układać jeden na drugim, pozwalają układać je w stosy i pobudzać ich kreatywność. Wykonuje dobre ćwiczenia.

Klocki są wodoodporne, więc ich czyszczenie jest dziecinnie proste. Po prostu wytrzyj wszelkie zabrudzenia.

Twórz małe tory przeszkód, aby sprawiać dzieciom wyzwania i zabawę.

Zalecane do stosowania pod bezpośrednim nadzorem osoby dorosłej.

Wprowadzenie produktów _

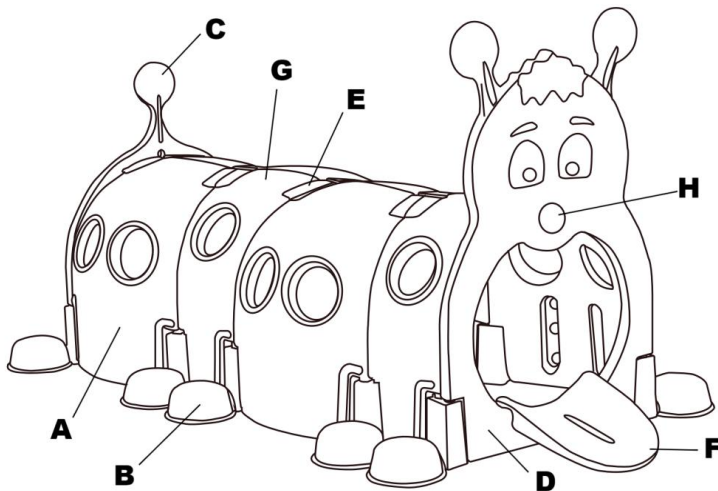

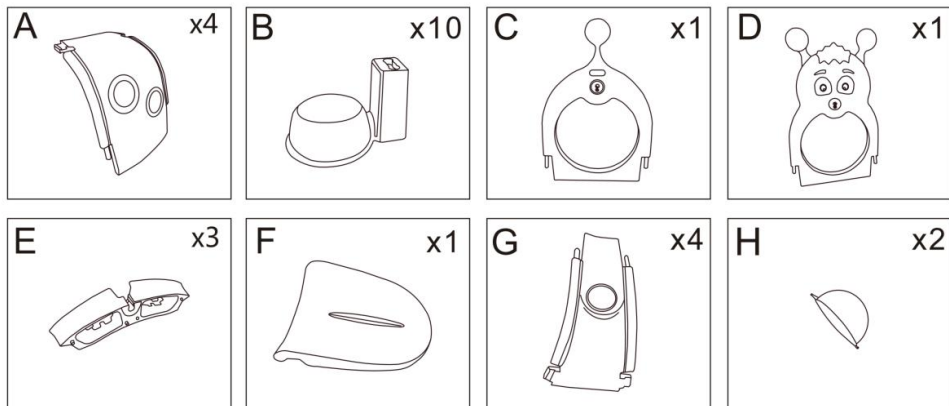

Procedura instalacji _

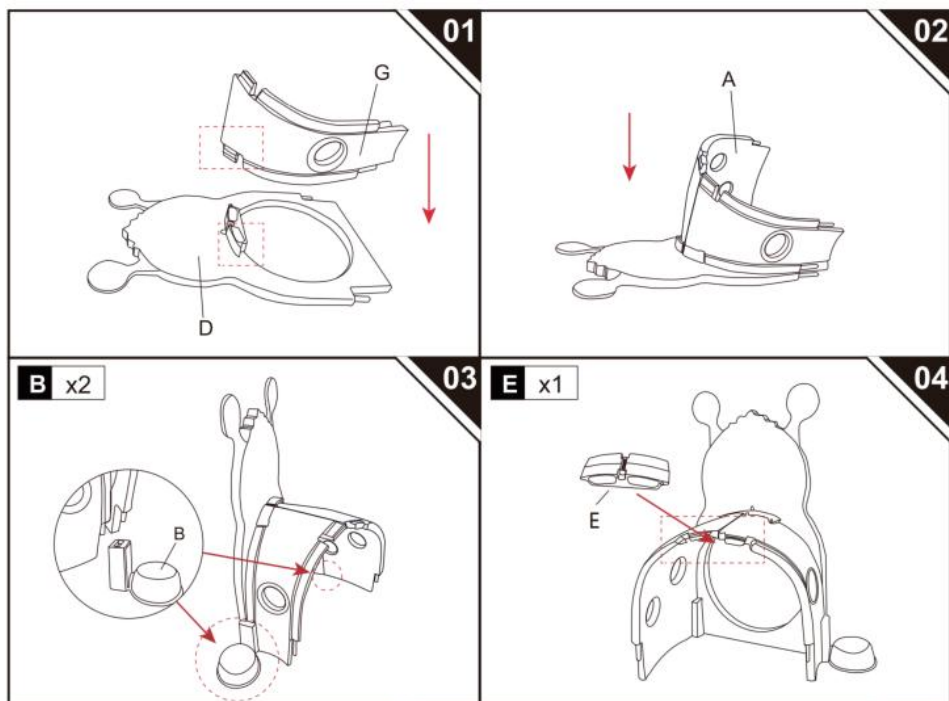

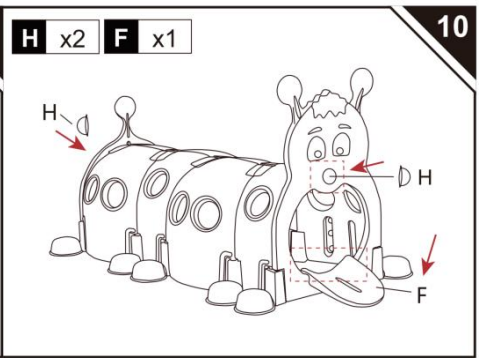
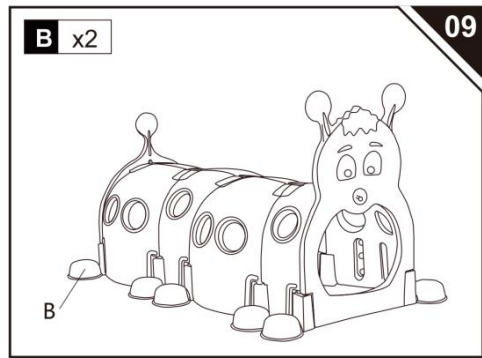
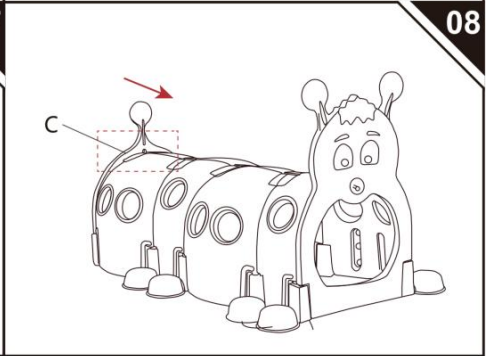
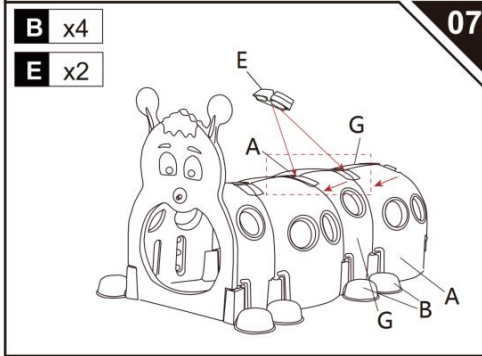
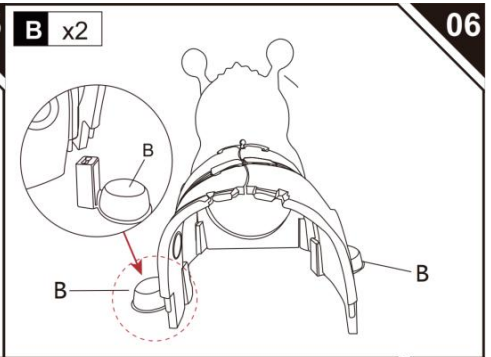
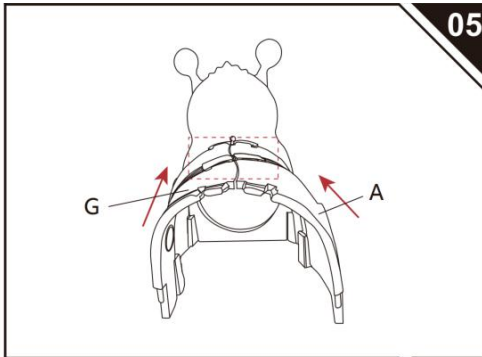



Adres: Baoshanqu Shuangchenglu 803long 11hao 1602A-1609shi
Szanghaj

Import do AUS: SIHAO PTY LTD . 1 ROKEVA STREETEASTWOOD
NSW 2122 Australia

Import do USA: Sanven Technology Ltd. Apartament 250, 9166 Anaheim
Place, Rancho Cucamonga, Kalifornia 91730



Pooledas Group Ltd
Unit 5 Albert Edward House, The Pavilions
Preston, United Kingdom



SHUNSHUN GmbH
Römeräcker 9 Z2021, 76351
Linkenheim-Hochstetten, Germany

Wyprodukowano w Chinach

VEVOR[®]

TOUGH TOOLS, HALF PRICE

Techniczny Certyfikat wsparcia i e-gwarancji

www.vevor.com/support

VEVOR[®]

TOUGH TOOLS, HALF PRICE

Technisch Ondersteuning en e-garantiecertificaat www.vevor.com/support

TUNNEL BEKLIMMEN

MODEL: LY-1602

We continue to be committed to provide you tools with competitive price.

"Save Half", "Half Price" or any other similar expressions used by us only represents an estimate of savings you might benefit from buying certain tools with us compared to the major top brands and dose not necessarily mean to cover all categories of tools offered by us. You are kindly reminded to verify carefully when you are placing an order with us if you are actually saving half in comparison with the top major brands.

VEVOR[®]

TOUGH TOOLS, HALF PRICE

CLIMB TUNNEL

MODEL: LY-1602

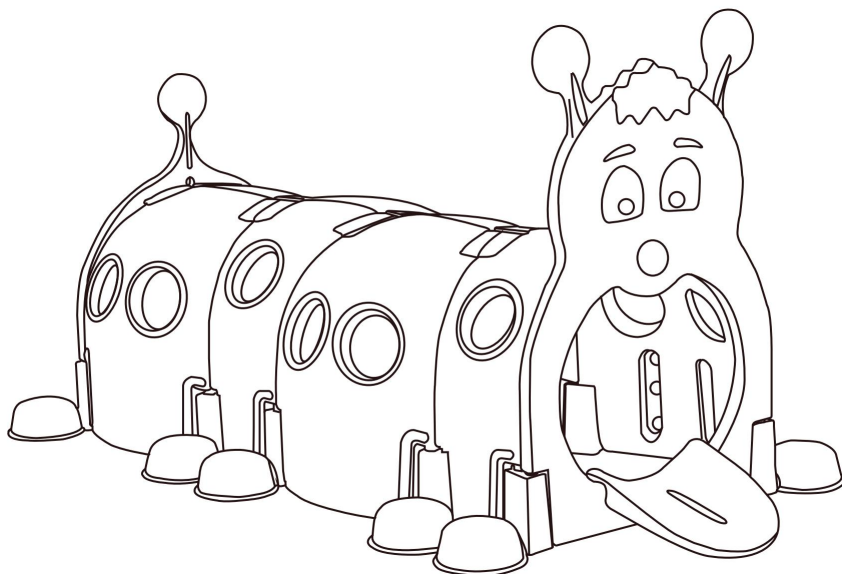

NEED HELP? CONTACT US!

Have product questions? Need technical support? Please feel free to contact us:

Technical Support and E-Warranty Certificate
www.vevor.com/support

This is the original instruction, please read all manual instructions carefully before operating. VEVOR reserves a clear interpretation of our user manual. The appearance of the product shall be subject to the product you received. Please forgive us that we won't inform you again if there are any technology or software updates on our product.



Waarschuwing-Om het risico op letsel te verminderen, moet de gebruiker de handleiding zorgvuldig lezen.

Met meerdere vormen creëer je een onbeperkte combinatie van structuren.

Door met deze blokken te spelen kan je baby zijn grove motoriek ontwikkelen.

Zeer zacht en dicht. Elk blok wordt geleverd met strak genaaide naden om scheuren te voorkomen.

Geen harde oppervlakken of scherpe hoeken die je kleintje kunnen bezeren tijdens het spelen.

Lichtgewicht en stapelbaar, laat ze stapelen en stimuleer hun creativiteit. Maakt een goede oefening.

De blokken zijn waterdicht, dus opruimen is een fluitje van een cent. Veeg eenvoudig het vuil weg.

Creëer kleine hindernisbanen om het voor uw baby's uitdagend en leuk te maken.

Aanbevolen voor gebruik onder direct toezicht van een volwassene.

Product Introductie _

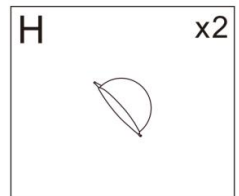
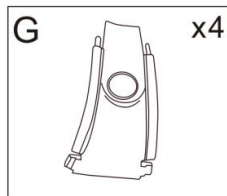
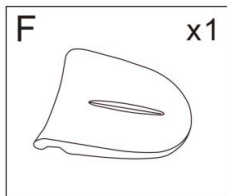
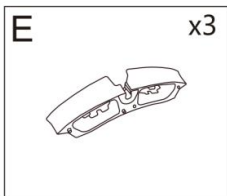
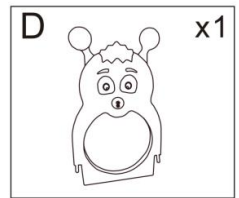
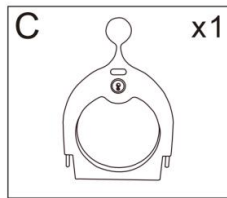
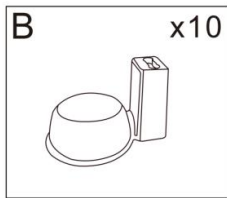
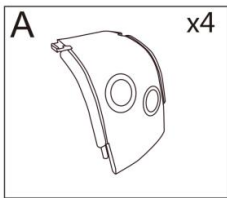
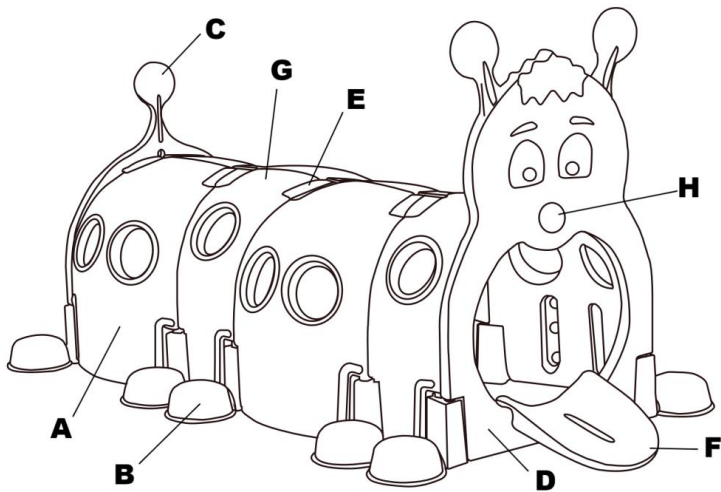

Installatieprocedure __

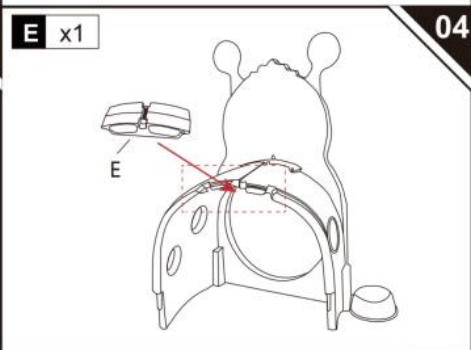
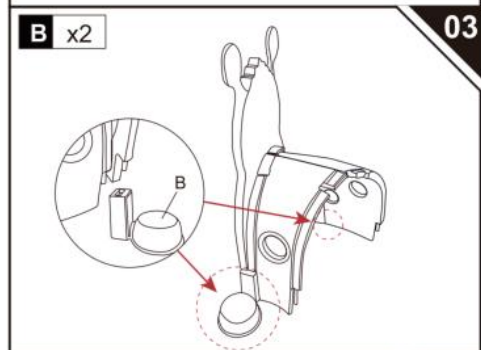
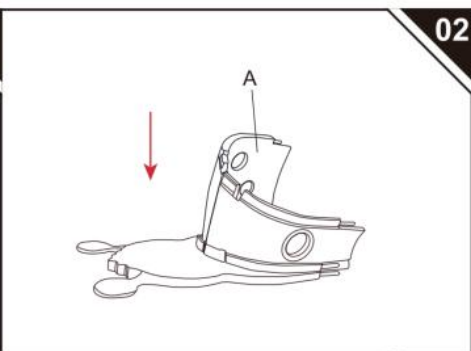
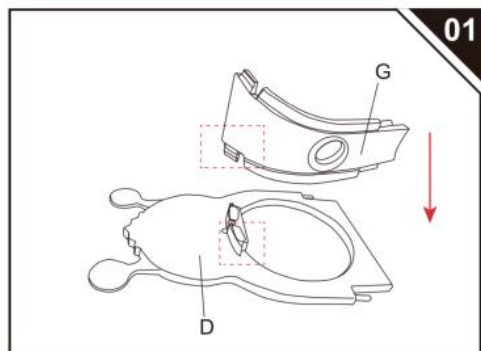

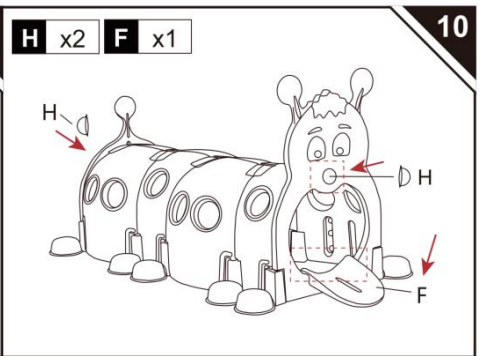
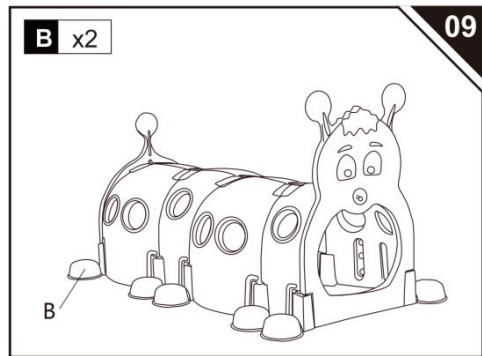
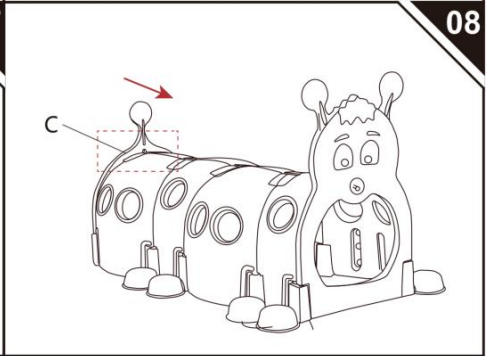
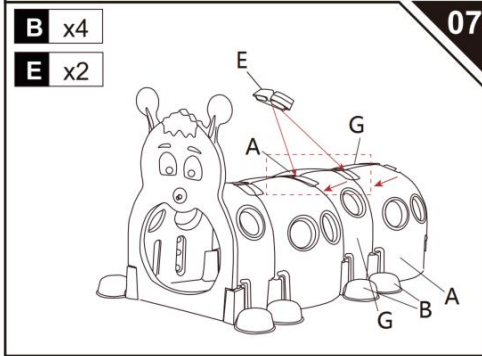
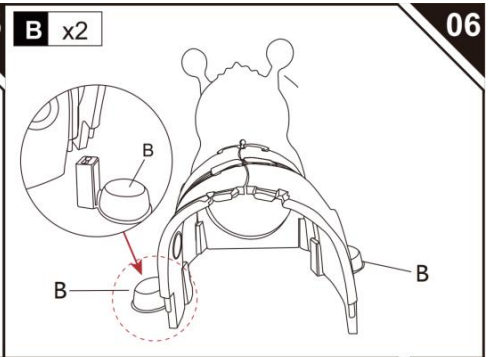
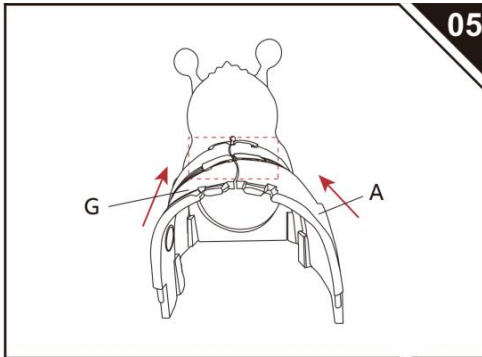



Adres: Baoshanqu Shuangchenglu 803long 11hao 1602A-1609shi
Shanghai

Geïmporteerd naar AUS: SIHAO PTY LTD . 1 ROKEVA
STREETEASTWOOD NSW 2122 Australië

Geïmporteerd naar de VS: Sanven Technology Ltd. Suite 250, 9166
Anaheim Place, Rancho Cucamonga, CA 91730



Pooledas Group Ltd
Unit 5 Albert Edward House, The Pavilions
Preston, United Kingdom



SHUNSHUN GmbH
Römeräcker 9 Z2021, 76351
Linkenheim-Hochstetten, Germany

Gemaakt in China

VEVOR[®]

TOUGH TOOLS, HALF PRICE

Technisch Ondersteuning en e-garantiecertificaat

www.vevor.com/support

VEVOR[®]

TOUGH TOOLS, HALF PRICE

Teknisk Support och e-garanticertifikat www.vevor.com/support

KLÄTTRA TUNNELN

MODELL: LY-1602

We continue to be committed to provide you tools with competitive price.

"Save Half", "Half Price" or any other similar expressions used by us only represents an estimate of savings you might benefit from buying certain tools with us compared to the major top brands and dose not necessarily mean to cover all categories of tools offered by us. You are kindly reminded to verify carefully when you are placing an order with us if you are actually saving half in comparison with the top major brands.

VEVOR®

TOUGH TOOLS, HALF PRICE

CLIMB TUNNEL

MODELL: LY-1602

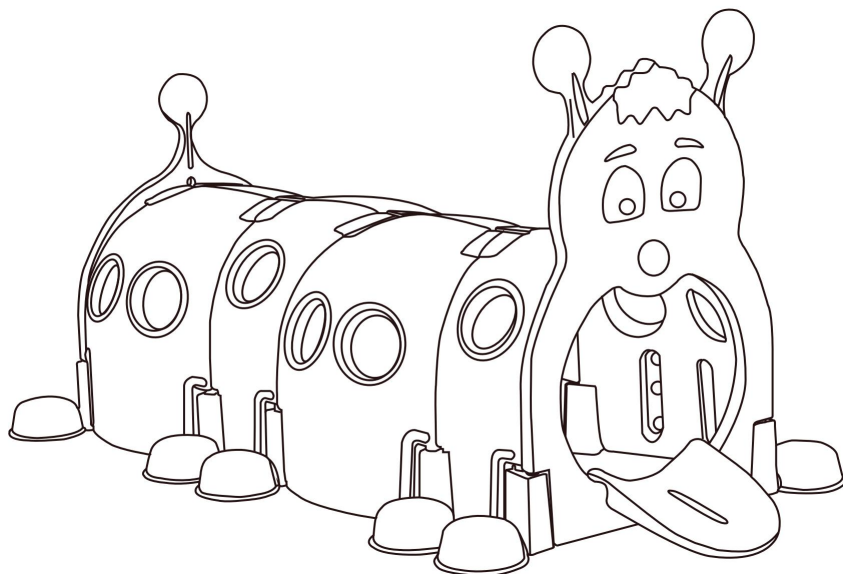

NEED HELP? CONTACT US!

Have product questions? Need technical support? Please feel free to contact us:

Technical Support and E-Warranty Certificate
www.vevor.com/support

This is the original instruction, please read all manual instructions carefully before operating. VEVOR reserves a clear interpretation of our user manual. The appearance of the product shall be subject to the product you received. Please forgive us that we won't inform you again if there are any technology or software updates on our product.



Varning - För att minska risken för skada måste användaren läsa instruktionerna noggrant.

Med flera former skapar du en obegränsad kombination av strukturer.

Ditt barn kan utveckla sina grovmotoriska färdigheter genom att leka med dessa klossar.

Mycket mjuk och tät. Varje block kommer med tätt sydda sömmar för att förhindra revor.

Inga hårda ytor eller skarpa hörn som kan skada din lilla när du spelar.

Lätt och stapelbar, låt dem stapla och stimulera deras kreativitet. Gör bra träning.

Blocken är vattentäta, så att rengöra dem är enkelt. Torka helt enkelt bort all smuts.

Skapa små hinderbanor för att göra saker utmanande och roliga för dina bebisar.

Rekommenderas att användas under direkt uppsikt av en vuxen.

Produkt introduktion _

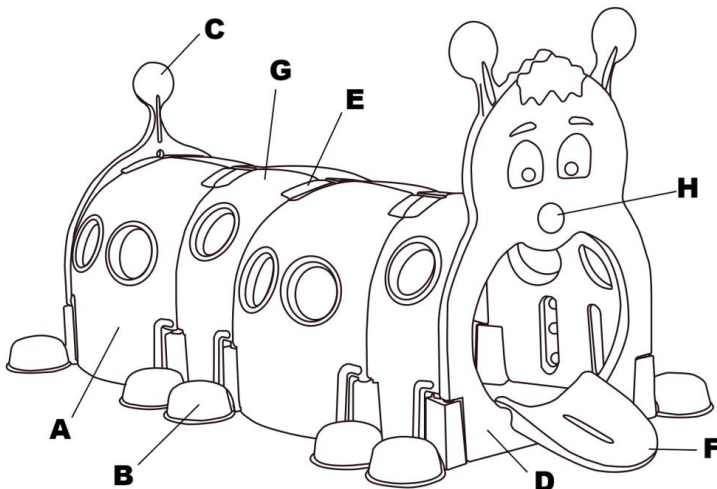

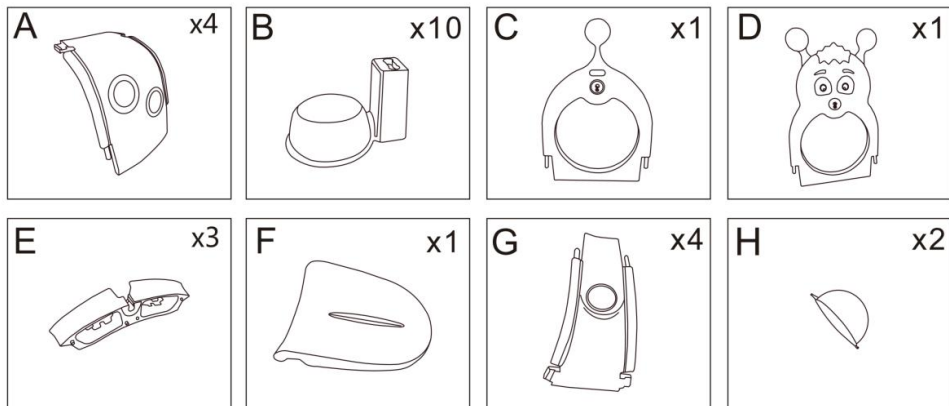

Installationsprocedur __

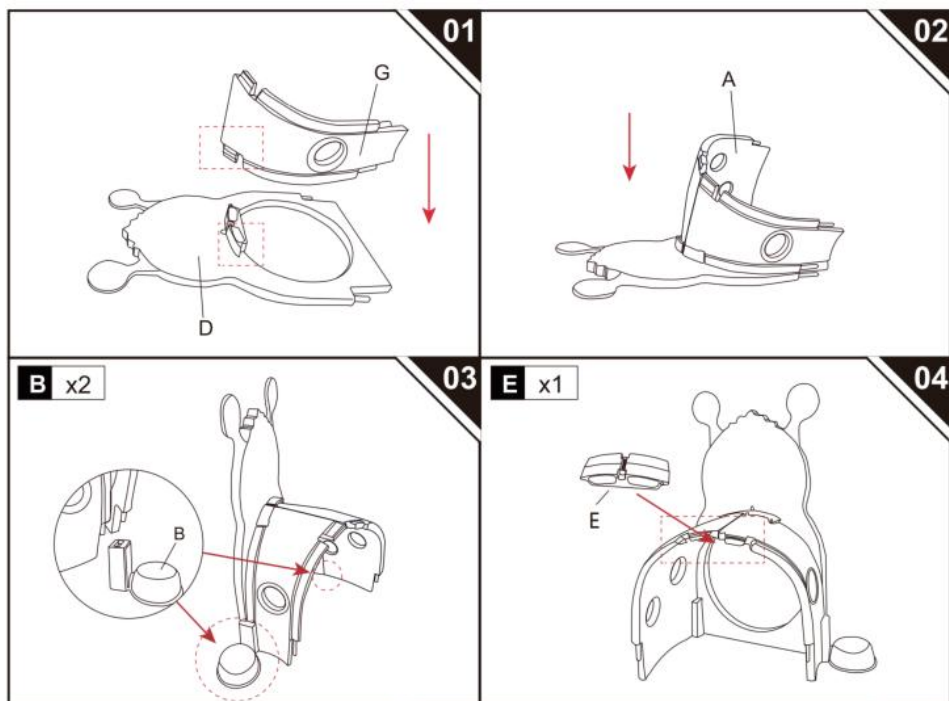

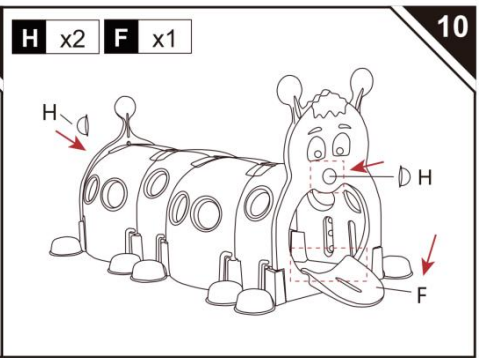
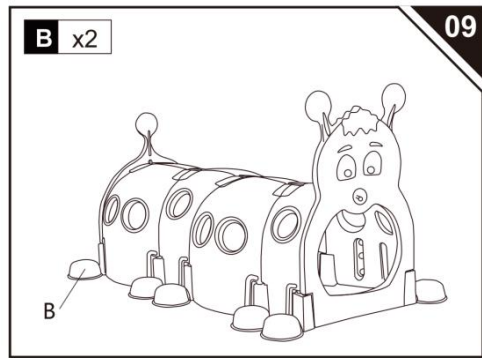
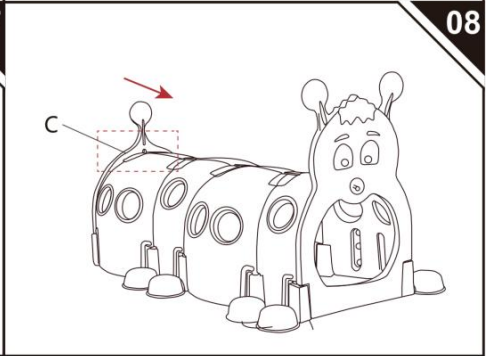
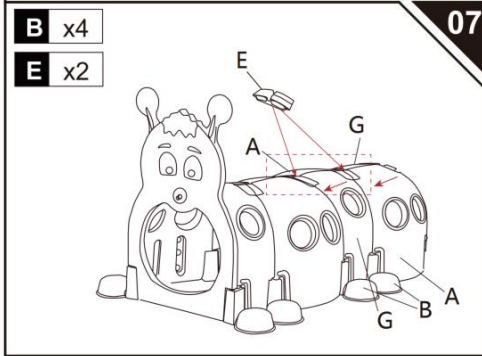
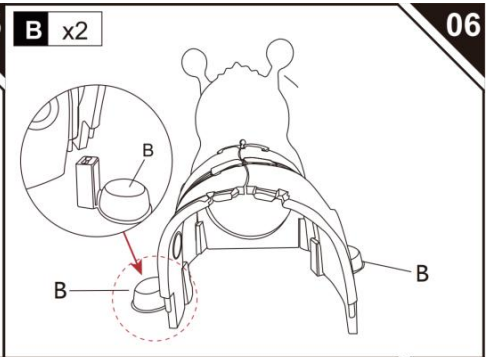
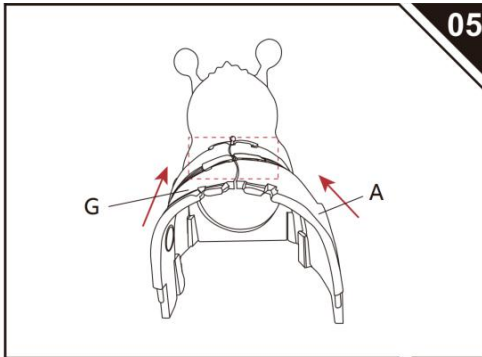



Adress: Baoshanqu Shuangchenglu 803long 11hao 1602A-1609shi
Shanghai

Importerad till AUS: SIHAO PTY LTD . 1 ROKEVA STREETEASTWOOD
NSW 2122 Australien

Importerad till USA: Sanven Technology Ltd. Suite 250, 9166 Anaheim
Place, Rancho Cucamonga, CA 91730



Pooledas Group Ltd
Unit 5 Albert Edward House, The Pavilions
Preston, United Kingdom



SHUNSHUN GmbH
Römeräcker 9 Z2021, 76351
Linkenheim-Hochstetten, Germany

Tillverkad i Kina

VEVOR[®]

TOUGH TOOLS, HALF PRICE

Teknisk Support och e-garanticertifikat

www.vevor.com/support