

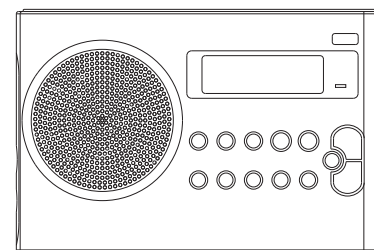

PR-D9W



GB

Version 1





Table of contents

<i>Important safety instructions</i>	2-3
<i>Introduction</i>	4
<i>Controls</i>	5-8
<i>Using your weather alert radio for the first time</i>	9
<i>Operating your radio – Search tuning AM/FM</i>	10
<i>Manual tuning – AM/FM / Setting up the tuning step increment</i>	11-12
<i>FM stereo / mono</i>	13
<i>Presetting stations / Recalling a my favorite station</i> ..	14-15
<i>Selecting a weather channel / Weather band and weather alert operation</i>	15-16
<i>Setting the clock manually / Setting the time format</i> ...	17-18
<i>Setting the alarm clock</i>	19-20
<i>Cancelling alarms / Snooze / Sleep timer</i>	21-22
<i>Display and Audio</i>	23
<i>Information</i>	24

Important safety instructions

1. Read and understand all safety and operating instructions before the radio is operated.
2. Retain instruction: The safety and operating instructions should be retained for future reference.
3. Heed warnings. All warnings on the appliance and operating instructions should be followed.
4. Follow all operations and use instructions.
5. Water and moisture: The appliance should not be used near water. Do not use near a bathtub, washbowl, laundry tub, kitchen sink, wet basement, swimming pool, etc.
6. Unplug the radio from the AC power outlet before cleaning. Use only a damp cloth for cleaning the exterior of the radio.
7. Do not place the radio on an unstable cart, stand, bracket or table. The radio may fall, causing serious personal injury and damage to the radio.
8. Ventilation: This radio should be situated so that its location or position does not interfere with its proper ventilation. For example, the radio should not be used on a bed, sofa, rug or other soft surfaces that may block the ventilation openings. It should not be placed in a built-in situation like a cabinet that may reduce air flow through the ventilation openings.
9. Power sources: The radio should be operated only from the type of power source indicated on the marking label. If you are not sure of the type of power supply to your home, consult your radio dealer or power company.
10. Mains adaptor: The mains adaptor should be positioned so it is not walked on, pinched, or items placed on top of it. Pay particular attention to wires at plugs, convenience receptacles, and the point where they exit from the unit. Unplug the mains adaptor by gripping the adaptor, not the wire. Operate the radio using only the current type of power source indicated. If you are not sure of the type of power supply to your home, consult your dealer or local power company.
11. Do not overload wall outlets or extension cords. This can result in a risk of fire or electrical shock. Never insert objects of any kind into the radio through opening. The objects may touch dangerous voltage points or short out parts. This could cause a fire or electrical shock.
12. If the radio is left unattended or unused for long periods of time, unplug it from the wall outlet. This will prevent damage caused by lightning or power line surges.
13. If the radio is left unattended and used for a long period of time, remove the batteries. The batteries may leak and damage furniture of your radio.

GB

- 
- 
14. Do not attempt to service the receiver yourself. Removing the cover may expose you to dangerous voltage, and will void the warranty. Refer all servicing to authorized service personnel.
 15. Never push objects of any kind into this radio through opening as they may touch dangerous voltage points or short-out parts that could result in a fire or electric shock. Never spill liquid of any kind of product.
 16. The appliance should be serviced by qualified service personnel when:
 - A. The power supply cord or the plug has been damaged.
 - B. Objects have fallen or liquid had been spilled into the radio.
 - C. The radio has been exposed to rain or water.
 - D. The radio does not appear to operate normally or exhibits a marked change in performance.
 - E. The radio has been dropped, or the enclosure damaged.



Introduction

The Sangean PR-D9W AM/FM digital weather alert compact portable radio provides the following range in a compact portable unit:

- ⦿ Radio for AM and FM broadcasts.
- ⦿ The PR-D9W features weather alert / siren function that works whenever hazardous weather condition occurs.
- ⦿ My favorite station allows you to save 19 stations in the preset memory.
- ⦿ Two alarm timers to wake you either with radio alarm or buzzer alarm with HWS (Humane Wake System).
- ⦿ Adjustable Sleep Timer which can be set to turn the radio off after between 15 and 120 minutes.
- ⦿ Super capacitor back up power for clock and stored memory preset for 3 minutes at least.
- ⦿ Battery charging capacity with LED indicator.
- ⦿ Button lock switch to keep the buttons protected when carrying the radio in motion.
- ⦿ LCD back-light with adjustable illumination.
- ⦿ NOAA weather band and weather alert / siren system

GB

Controls

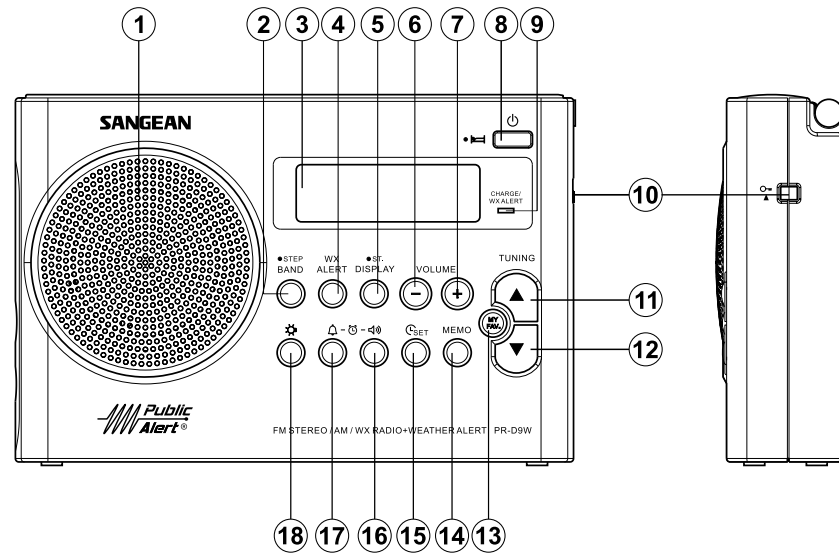

- | | |
|---------------------------------------|------------------------|
| 1. Speaker | 10. Lock switch |
| 2. Band / step button | 11. Tuning up |
| 3. LCD display | 12. Tuning down |
| 4. Weather alert | 13. My favorite button |
| 5. Display / Stereo - mono | 14. Memo |
| 6. Volume down | 15. Clock time |
| 7. Volume up | 16. Radio alarm |
| 8. Standby / Sleep timer | 17. Buzzer alarm |
| 9. Charging / Weather alert indicator | 18. Backlight |

Controls

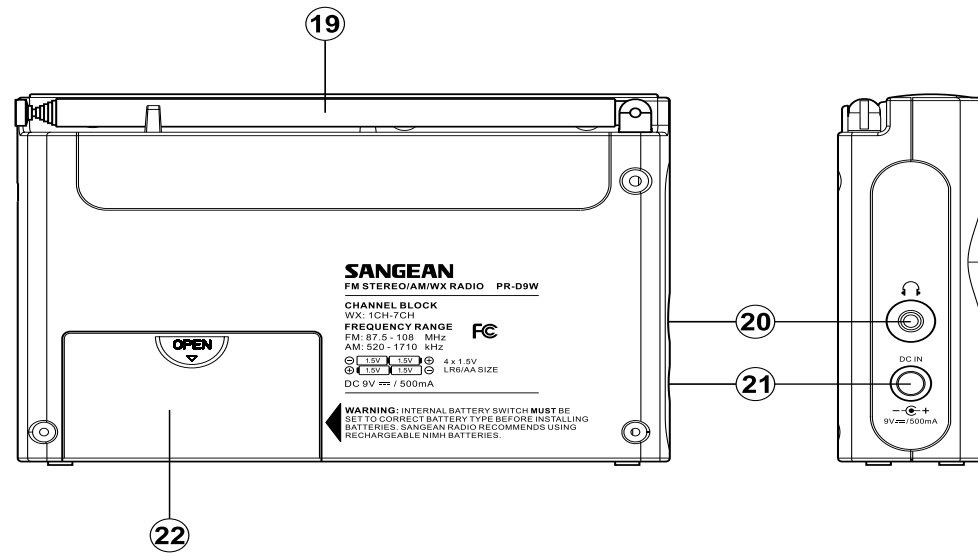

GB

- 19. FM antenna
- 20. Headphone jack
- 21. DC in socket
- 22. Battery compartment

Controls

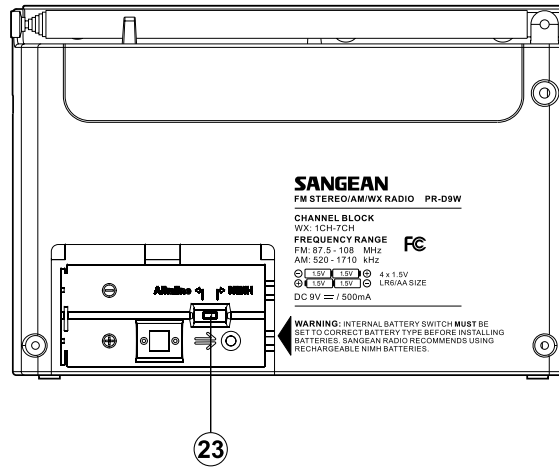

23. Alkaline/NiMH/NiCad rechargeable battery switch

Display icon

- A. Weather broadcast mode / siren mode icon
- B. Stereo indicator
- C. Buzzer alarm indicator
- D. Radio alarm indicator
- E. Sleep timer icon
- F. Lock switch icon
- G. Volume icon
- H. Battery capacity indicator
- I. My favorite icon
- J. Memory preset
- K. FM 50kHz display
- L. Time indicator / Frequency display
- M. AM/FM/WX band icon
- N. PM display

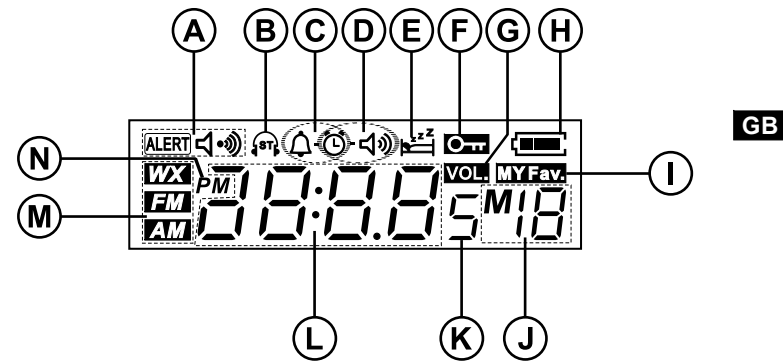

Using the weather alert radio for the first time

Battery operation

1. Remove the battery cover on the rear of the unit by pressing the catch.

Note:

Before you insert the batteries, if you use non-rechargeable batteries, make sure the NiMH/Alkaline switch which located inside the battery compartment is switched to Alkaline position. If you use rechargeable batteries, make sure to switch NiMH/Alkaline switch to NiMH position.

2. Insert four UM-3 (AA size) batteries into the spaces in the compartment.
3. Take care to ensure all batteries are inserted with correct polarity as shown on the rear cabinet. Replace the battery cover.
4. Reduced power, distortion, "stuttering sound" and low battery capacity indicator flashing on the display are all signs that the batteries need replacing.
5. If the radio is not to be used for any extended period of time, it is recommended that the batteries are removed from the radio.

Using the AC power adaptor

The AC power adaptor required for this unit should be 9 volts DC at 0.5 A center pin positive.

Insert the adaptor plug into the DC socket on the left side of the radio.

Plug the adaptor into a standard mains socket outlet.

Whenever the adaptor is used, the batteries are automatically disconnected. The AC adaptor should be disconnected from the main supply when not in use.

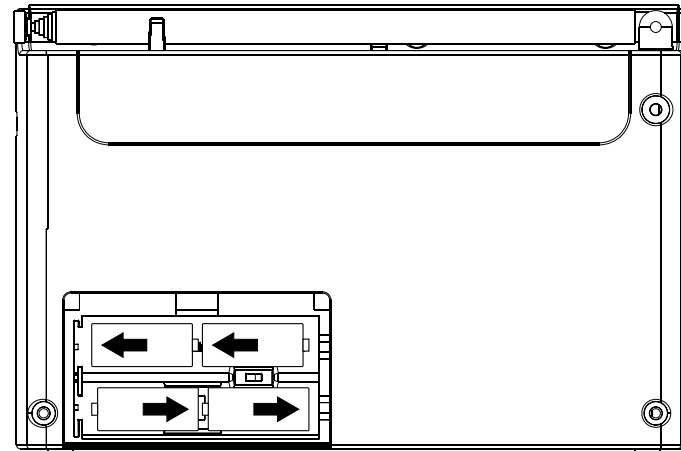

Operating your radio – Search tuning AM/FM

1. Fully extend the antenna above the radio. Press the Standby button to switch on your radio.
2. Press the Band button to select the required band.
3. Press and hold the Tuning up button, your radio will scan in an upwards direction (low frequency to high frequency) and stop automatically when it finds a station of sufficient strength.
4. After a few seconds the display will update. The display will show the frequency of the signal found. Press and hold the Tuning down button, and your radio will scan in a downwards direction (high frequency to low frequency) and stop automatically when it finds a station of sufficient strength.
5. To find other stations, press and release the Tuning Up / Down buttons as before.
6. When the waveband is reached will recommence from the opposite end of the waveband end.
7. Adjust the volume control by pressing the Volume up/down button to the required setting.

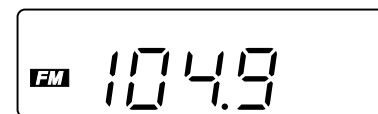
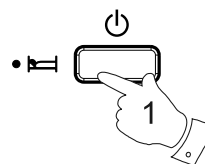

GB

•STEP
BAND



TUNING

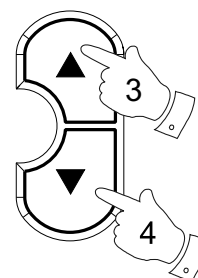

VOLUME

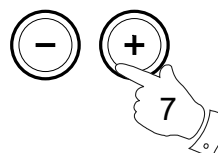

Manual tuning – AM/FM

1. Press the Standby button to switch on your radio.
2. Press the Band button to select the required band. Fully extend the antenna for best reception.
3. Press and release the Tuning up/down button to tune to a station.
The FM frequency will change in steps of 100/200kHz and
AM frequency will change in steps of 9/10kHz.
4. When the waveband end is reached the radio will recommence tuning from the opposite waveband end.
5. Set the Volume using the Volume Up/Down buttons to the desired settings.

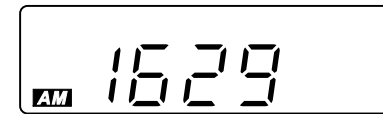
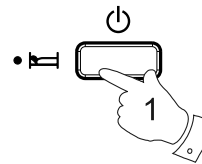

•STEP
BAND

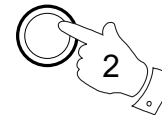

TUNING

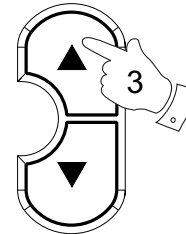

VOLUME

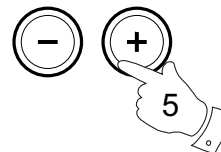

Setting up the tuning step increment

1. Make sure your radio is in power off mode.
2. Press and hold the Band/step button until the FM tuning step setting begins to flash.
3. Press the Tuning Up / Down buttons to select either 100kHz or 200kHz for FM radio, and press and release the Band/step button to confirm the setting. And the AM tuning step setting will begin to flash.
4. Press the Tuning Up / Down buttons to select either 9kHz or 10kHz for AM radio, then press and release the Band/step button to confirm the setting.

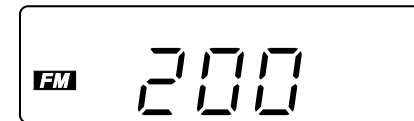
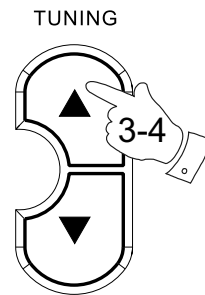

GB

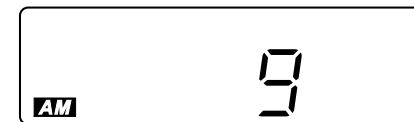

FM stereo (Auto) / mono

If the FM radio station being listened to has a weak signal some hiss may be audible. It is possible to reduce this hiss by forcing the radio to play the station in mono rather than stereo.

1. Press the Step/Band button to select the FM band and tune to the required FM stations as previously described.
2. The display will show the current setting of the station being listened to. The stereo indicator will show on the LCD display when the FM station tuned to has stereo signal.
3. If the setting is Auto, press and hold the Display/St. button to switch to Mono mode to reduce the hiss. The stereo indicator will disappear from the display.
4. To return to Auto (stereo) mode press and hold the Display/St. button again, so that the radio will switch back to Auto mode.

•STEP
BAND



•ST.
DISPLAY



Presetting stations (My Favorite)

You may store your preferred AM/FM radio stations to My Favorite Stations (1 to 19). The procedure for setting My Favorite Stations is described below. Note that the radios for AM and FM are saved together in the My Favorite so there are nineteen of them. My Favorite Stations are preserved in the event of a power failure.

1. Press the Standby button to switch on your radio.
2. Tune to the required station as previously described.
3. Press and release the Memo button until M is flashing on the display.
4. Press the Tuning Up/Down button until the desired My Favorite Station number is flashing on the display.
5. Press and release the Memo button again. The setting will be stored and the radio will beep once.

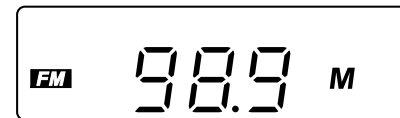
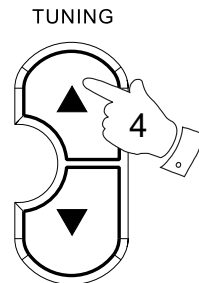
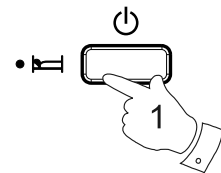

GB

Recalling a my favorite station

1. Press the Standby button to switch on your radio.
2. Momentarily press the My Fav. Button to cause your radio switch to My Favorite mode and tune to the station stored as My Favorite Station. The My favorite icon will show on the display.
3. Press and release the Tuning Up or Down button to select your desired My Favorite Station number and the radio will automatically tune to the specified My Favorite station.

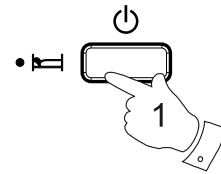

Selecting the weather channel

To receive alerts, you must first select the correct weather channel. NOAA broadcasts on the weather band on seven channels in 25kHz increments, between the frequencies of 162.400MHz and 162.550MHz.

To identify the appropriate channel for your area, visit the NOAA website at: <http://www.nws.noaa.gov/nwr/indexnw.htm>

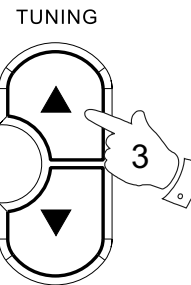

Weather Band and weather alert operation

1. When the radio is on, press the WX button to switch to the Weather Band.
2. Press the Tuning Up/Down buttons to select the desired weather channel. The LCD display will show the channel number.
3. When the radio is in the weather band, press and hold the WX button for more than 3 seconds to enter the Weather Broadcast mode. When a Weather alert occurs, your radio will automatically switch to Weather broadcast mode.
4. When the radio is in the weather band, press and hold the WX button again to enter the Weather Alert mode and the red WX Alert LED will be on. When a Weather alert occurs, your radio will automatically switch to Weather siren mode and the red WX Alert LED will be flashing.

Place the radio where it gets the best reception. To turn off the weather broadcast/siren press and hold the WX button again.

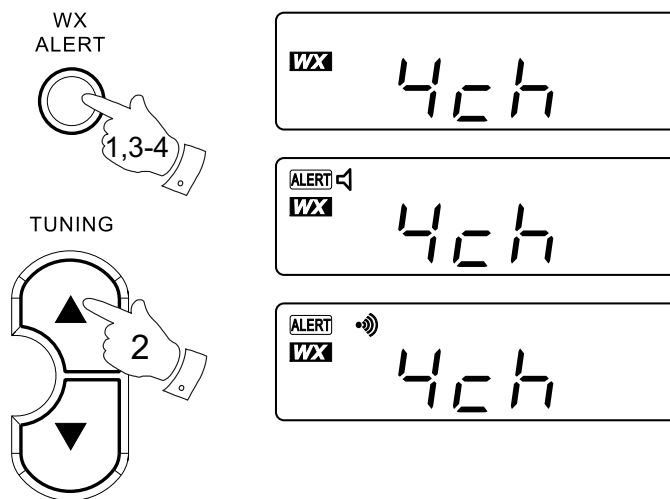

GB

Clock and Alarms

Setting the clock manually

The clock of PR-D9W needs to be set up manually before the alarm function can be used.

1. Press and hold the clock time button until the radio beeps once and the hour digits of time setting begins to flash.
2. Press the Tuning Up / Down button to adjust the hour setting as required.
3. Press and release the clock time button to enter the setting, and the minute digits of time setting will begin to flash. Press the Tuning Up / Down button to adjust the minute setting as required.
4. Press and release the clock time button again to finish the setting. Your radio clock is now set.

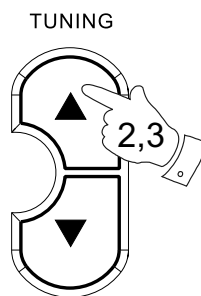
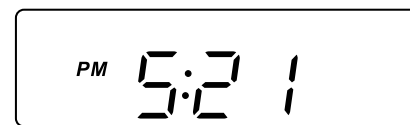
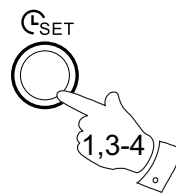

Setting the time format

The clock display used in stand-by mode and on the playing mode screens can be set to 12 or 24 hour format. The selected format is then also used when setting the alarms.

1. With your radio switched off, press and hold the Band/step button until the radio beeps once and the display shows FM tuning step setting flashing.
2. Press and release the Band/step button, and the display will show AM tuning step setting flashing. Press and release the Band/step button again, and the display will show time format setting flashing.
3. Press the Tuning Up / Down button to select either 12 or 24 hour format.
4. Press and release the Band/step button to confirm the setting.

If the 12 hour clock format is chosen, the radio will then use the 12 hour clock for the setting of alarms, and will display a 12 hour clock for the setting of alarms, and will display a 12 hour clock with an AM or PM indicator.

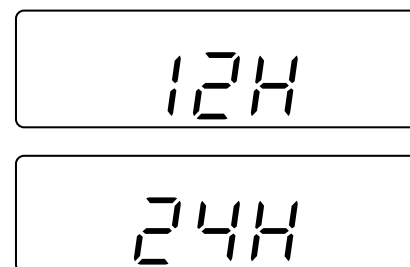
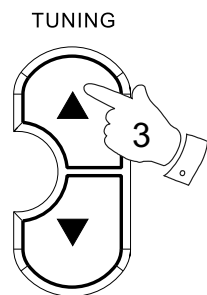
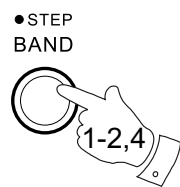

GB

Setting the alarm clock

Your PR-D9W radio has two alarms which can each be set to wake you to buzzer or AM/FM radio alarm. The alarms may be set while the unit is in standby mode or while playing.

1. Before setting an alarm ensure that the clock time is set.
Press and hold one of the Alarm buttons as required, buzzer or radio, until the radio beeps once to enter the setting and the alarm hour digits will flash.
2. Press the Tuning Up or Down buttons to choose the alarm hour and then press and release the according alarm button to enter the hour setting. The alarm minute digits will then flash on the display.
3. Press the Tuning Up or Down buttons to choose the alarm minute and then press and release the according alarm button to enter the minute setting.
4. If the buzzer alarm is selected, the alarm volume setting will then show on the display. Press the Tuning Up or Down buttons to adjust the volume from 1-7 as required, then press and release the according alarm button to confirm the setting.
5. If the radio alarm is selected, the radio band/frequency setting will then show on the display. Press the Step/band button to choose the band as required, and press the Tuning Up/Down buttons to adjust the frequency as required. Press and release the according alarm button to confirm the setting, and then the volume setting will show on the display.

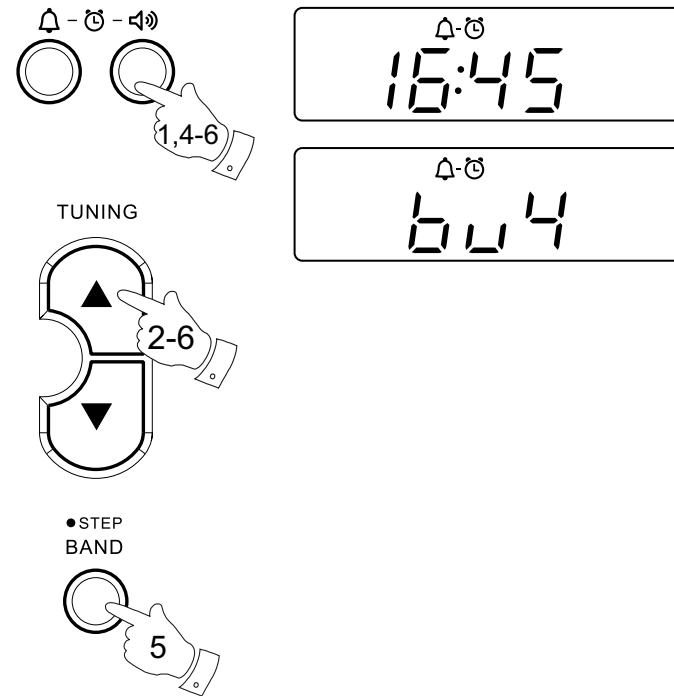



6. Press the Tuning Up or Down buttons to adjust the volume from 1-30 as required, and press and release the according alarm button to confirm the setting. The alarm has now been set and the unit will revert to the previous display.

To view an alarm setting, press and release the required alarm button and the alarm time will show on the display.

When the buzzer alarm activates, the alarm will start softly and gradually increase in level.

The alarm will sound for 60 minutes unless cancelled.

GB



Cancelling alarms

1. When an alarm is sounding it can be cancelled by pressing the Standby button.
2. To cancel an alarm at any other time, press and hold the alarm button until the alarm indicator disappears from the display.

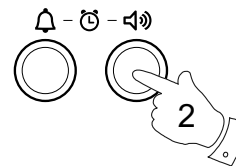
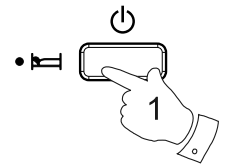

Snooze

1. When the alarm sounds, pressing any button other than the Standby button will silence the alarm for five minutes. The snooze symbol will appear in the display. To cancel the Snooze, simply press the Standby button to turn off the radio.

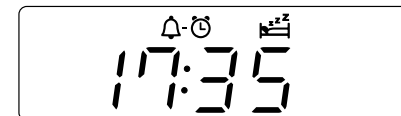

Sleep timer function

Your radio can be set to turn off after a preset time has elapsed.
The sleep timer setting can be adjusted between 15 and 120 minutes.

1. To use the sleep timer, press and hold the Standby button to enter the sleep timer setup.
2. Keep pressing the Standby button and the sleep timer options will cycle on the display. Stop until your desired sleep time is reached. The options are 60, 45, 30, 15, 120 or 90 minutes.
3. A sleep timer icon will appear on the display indicating an active sleep timer. Your radio will switch off after the preset auto sleep time has elapsed.
4. To cancel the sleep timer function before the preset time has elapsed, simply press the Standby button to switch off the radio.

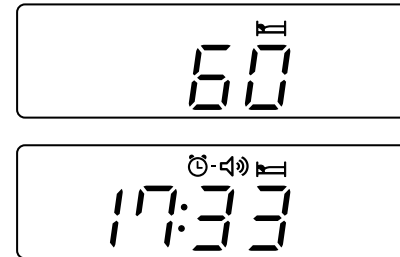
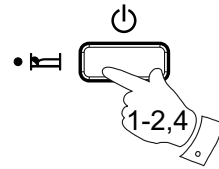

GB

Display and Audio

Brightness control

The brightness of the display may be adjusted. If you use the unit in the bedroom, you may prefer a higher brightness level.

1. Repeatedly press the backlight button to change the current brightness level. The backlight level will change at the same time so that you can see the effect of the change.
2. The brightness values range from level 1-3 and off. Stop when your desired backlight level is reached.

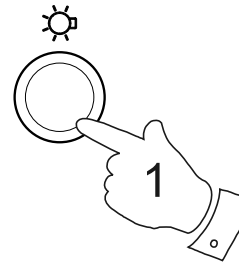

Headphone socket

A 3.5mm stereo headphone socket is provided on the left hand side of your radio for use with headphones. Inserting a plug automatically mutes the internal speaker.

IMPORTANT:

Excessive sound pressure from earphones and headphones can cause hearing loss.



Information

Specifications

Power Requirements

Mains DC in 9V / 0.5A

Frequency Range

FM 87.5 – 108 MHz

AM 520 – 1710 kHz (USA version)

CHANNEL BLOCK

WX: 1CH-7CH

Battery

4 X 1.5V Size "AA" / UM-3 / LR6

Circuit Features

Loudspeaker 2.25" 8 ohm full range

Output Power 0.5 Watt / 0.25 Watt (batteries)

Headphone socket 3.5mm dia.

Aerial System FM telescopic rod antenna

GB