

Canon

RF

200-800mm F6.3-9 IS USM

Instructions

ENG

Thank you for purchasing a Canon product.

Canon RF200-800mm F6.3-9 IS USM is a telephoto zoom lens for use with EOS R series cameras.

- “IS” stands for Image Stabilizer.
- “USM” stands for Ultrasonic Motor.

Camera Firmware

Please use the latest version of firmware with the camera in use. For details on whether the firmware is the latest version or not, and for details on updating the firmware, please check the Canon website.

Conventions used in these instructions



Warning to prevent lens or camera malfunction or damage.



Supplementary notes on using the lens and taking pictures.

Safety Precautions

Precautions to ensure that the camera is used safely. Read these precautions thoroughly. Make sure all details are observed in order to prevent risks and injury to the user and other people.



Warning

Details pertaining to risks that may result in death or serious injury.

- **Do not look directly at the sun or other strong light sources through a lens.** This may result in loss of sight.
- **Do not point the lens or camera at the sun or photograph it.** This is because the lens concentrates the sun's rays even when the sun is outside the image area or when shooting with backlight, which could cause malfunction or fire.
- **Do not leave a lens in the sun without the lens cap attached.** The lens may concentrate entering sunlight and cause a malfunction or fire.
- **Where the lens is mounted on a camera, make sure to properly support the lens.** If you hold only the camera, the lens may fall off the camera and cause a malfunction or injury.
- **Be sure to attach the included strap to the lens when carrying a camera around with the lens mounted on it.** Using the strap for the camera may allow the lens to fall off the camera and cause a malfunction or injury.



Caution

Details pertaining to risks that may result in injury or damage to other objects.

- **Do not leave the product in places exposed to extremely high or low temperatures.** The product may cause burns or injury when touched.
- **Do not insert your hand or fingers into the product.** This may result in injury.
- **Attach a tripod or monopod that is sufficiently sturdy to the tripod mount on the lens.**

General Precautions

Handling Precautions

- Do not leave the product in excessive heat such as in a car in direct sunlight. High temperatures can cause the product to malfunction.
- If the lens is taken from a cold environment into a warm one, condensation may develop on the lens surface and internal parts. To prevent condensation in this case, first put the lens into an airtight plastic bag before taking it from a cold to warm environment. Then take out the lens after it has warmed gradually. Do the same when taking the lens from a warm environment into a cold one.
- The lens interior may appear to waver, but this does not indicate a defect or failure, and will not cause any problems in use.
- In order to optimize aperture control, there are occasions in which the diaphragm blades will move during zooming and focusing, even when the aperture value is set for aperture priority AE or manual exposure, etc.
- Please also read any lens related handling precautions listed in your camera's instruction manual.

This device complies with Part 15 of the FCC Rules.

Operation is subject to the following two conditions: (1) This device may not cause harmful interference, and (2) this device must accept any interference received, including interference that may cause undesired operation.

Do not make any changes or modifications to the equipment unless otherwise specified in the instructions. If such changes or modifications should be made, you could be required to stop operation of the equipment.

This equipment has been tested and found to comply with the limits for a class B digital device, pursuant to part 15 of the FCC Rules. These limits are designed to provide reasonable protection against harmful interference in a residential installation. This equipment generates, uses and can radiate radio frequency energy and, if not installed and used in accordance with the instructions, may cause harmful interference to radio communications.

However, there is no guarantee that interference will not occur in a particular installation. If this equipment does cause harmful interference to radio or television reception, which can be determined by turning the equipment off and on, the user is encouraged to try to correct the interference by one or more of the following measures:

- Reorient or relocate the receiving antenna.
- Increase the separation between the equipment and receiver.
- Connect the equipment into an outlet on a circuit different from that to which the receiver is connected.
- Consult the dealer or an experienced radio/TV technician for help.

Nomenclature

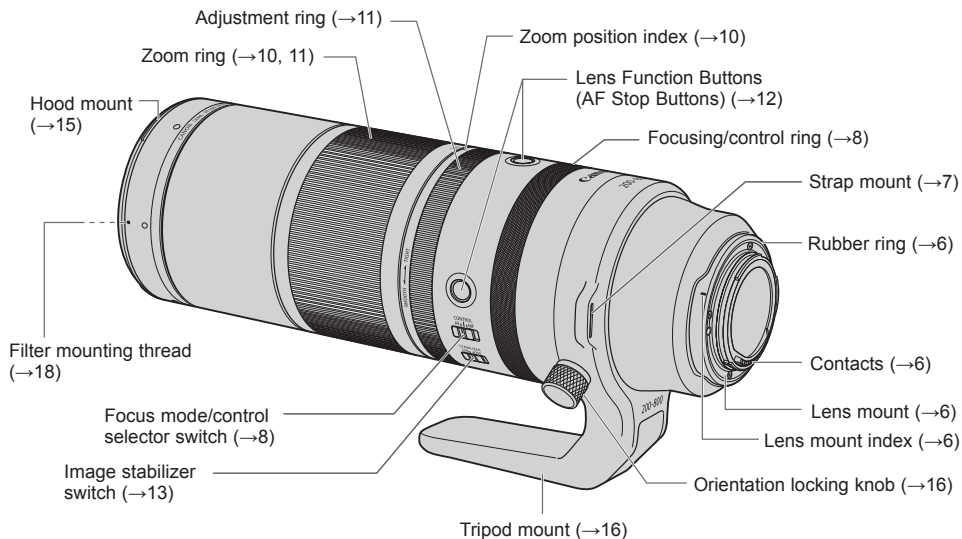

- For detailed information, reference page numbers are provided in parentheses (→ **).

1. Attaching and Detaching the Lens

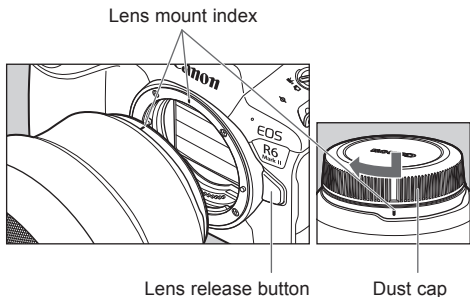

Attaching the Lens

Align the lens mount indexes of the lens and camera, and turn the lens clockwise until you hear a click.

Detaching the Lens

Turn the lens counterclockwise while pressing the camera's lens release button. Detach the lens once it has stopped turning.

Please refer to the camera's instructions for details.

- Set the camera's power switch to OFF when attaching or detaching the lens.
- After detaching the lens, place the lens with the rear end up and attach the dust cap to prevent the lens surface and contacts from getting scratched. Make sure the lens and dust cap mount indexes are aligned when attaching the dust cap.
- Contacts that are scratched, soiled, or have fingerprints on them may result in faulty connections or corrosion, which may lead to malfunctions. If the contacts get soiled, clean them with a soft cloth.
- The lens mount has a rubber ring to improve dust-resistance and water-resistance performance. This rubber ring may cause friction marks to appear around the camera's lens mount, although this will have no effect on usage.



- Since the lens is heavier than the camera, turn the camera when attaching or detaching the lens. Ensuring that the lens can rest safely on its own is recommended, such as first mounting it on a tripod.
- Rubber rings can be replaced at a Canon Service Center. (chargeable)

2. Attaching the Strap

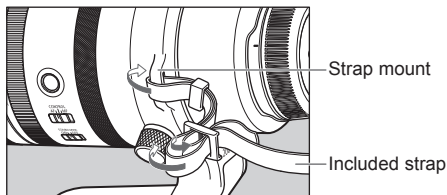

Thread the end of the strap through the strap mount on the lens and then back through the clasp on the strap. Pull the strap tight and check that there is no slack in the clasp.

- Before using the lens, check that the strap is attached securely, that it is not worn (damaged), etc.

3. Focusing/Control ring

The focusing/control ring can be used as either a focusing ring or a control ring.

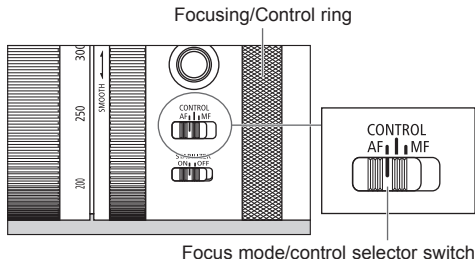

Use as a Focusing Ring

Set the focus mode/control selector switch to AF or MF.

To shoot in autofocus (AF) mode, set the focus mode/control selector switch to AF. Table*1

To use only manual focusing (MF), set the focus mode/control selector switch to MF, and focus by turning the focusing ring (focusing/control ring). Table*2

Table: List of Focus Mode and Focusing/Control Ring Functions Using the Focus Mode/Control Selector Switch

	Focus mode/ Control selector switch		
	*1 AF	*3 CONTROL	*2 MF
Focus mode	AF	*4 AF/ *5 MF	MF
Focusing/ control ring functions	Focusing ring	Control ring	Focusing ring

Use as a Control Ring

Set the focus mode/control selector switch to CONTROL. Table*3

Set the control ring function using the camera's menu. The control ring can be assigned the functions that are commonly used with cameras, such as shutter speed and aperture settings. Please refer to the camera's instructions for details on how to use the control ring.

Focusing/Control ring



- Delayed focus may occur if the focusing ring (focusing/control ring) is quickly turned.
- Setting the focus mode/control selector switch to CONTROL will fix the focus mode as AF. Table*4
However, depending on the camera used, it is possible to switch the focus mode to MF on the camera. Table*5
Please refer to the camera's instructions for details.



- The lens' focusing ring (focusing/control ring) is electronic.
- With a camera capable of electronic full-time manual focus, manual focusing is possible while the camera is operable. However, this requires a change in camera settings.
- When AF operation is set to One-Shot AF, manual focus is possible after autofocusing has been completed by continuing to press the shutter button halfway (electronic manual focus function). However, this requires a change in camera settings.
- When movie recording, the AF speed will be slower than the still photo shooting mode. It is possible to adjust the AF speed on the camera by setting Movie Servo AF to [Enable].

Please refer to the camera's instructions for details.

4. Zooming

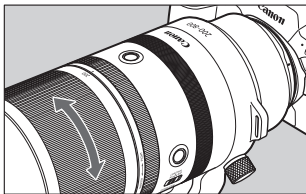

To zoom, turn the zoom ring.

Minimum focusing distance: changes according to the focal length.

Focal length	Minimum focusing distance	Magnification
200 mm	0.8 m / 2.62 ft.	0.25x
400 mm	1.8 m / 5.91 ft.	0.19x
600 mm	2.8 m / 9.19 ft.	0.18x
800 mm	3.3 m / 10.83 ft.	0.2x



- Be sure to finish zooming before focusing. Zooming after focusing can affect the focus.
- Once a close-up subject is in focus, zooming may cause the subject to come out of focus. In this instance, move back from the subject and refocus.
- Blurring may temporarily occur if the zoom ring is quickly turned.
- Please be careful not to let your fingers get caught in between the lens portion that extends and the lens body when zooming.

5. Adjusting the Zoom Ring Operational Feeling

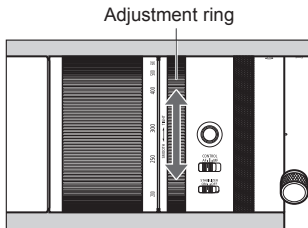

You can adjust the operational feeling (weight of movement) of the zoom ring to a preferred level. Turn the adjustment ring toward SMOOTH to lighten the feeling, and toward TIGHT to strengthen it.

- It is recommended that the adjustment ring is turned fully to the TIGHT setting when not in use to prevent the front of the lens from being unintentionally extended.
- If the lens is aimed upward or downward in the TELE setting with the adjustment ring set at SMOOTH, there are cases in which the lens will contract to the WIDE setting. Please be careful not to let your fingers get caught in between the zoom extending portion and the lens body.

6. Lens Function Buttons (AF Stop Buttons)

In the default settings, the lens function button serves as a AF stop button. You can assign different functions to the button from the [Customize buttons] section of the camera. Please refer to the camera's instructions for details.

Lens function buttons
(AF stop buttons)

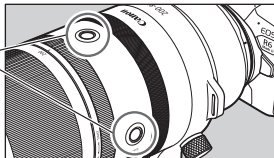

Use as a AF stop button

During autofocus operation, you can press an AF stop button to temporarily pause autofocus, and then release the button to resume.

Press an AF stop button to maintain a focusing distance or to avoid focus search.

Press the shutter button while holding down an AF stop button to shoot at that focusing distance.

- Useful when autofocus is operating mostly in Servo AF.

7. Image Stabilizer

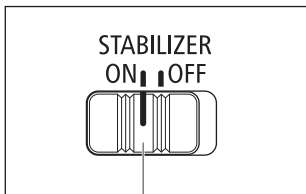

Image stabilizer switch

Set the image stabilizer switch to ON when you want to use the Image Stabilizer.

- This function provides image stabilization appropriate for shooting conditions (such as shooting still subjects and panning shots).
- The coordinated control will work in combination with cameras with in-body Image Stabilizer.
- Set the image stabilizer switch to OFF when you are not going to use the Image Stabilizer.



- The Image Stabilizer cannot compensate for a blurred shot caused by a subject that moved.
- The Image Stabilizer may not be fully effective if you shoot from a violently shaking vehicle or other transportation.
- If using a camera that allows you to change the shutter mode setting, [Elec. 1st-curtain] or [Electronic] settings is recommended* to allow the Image Stabilizer to be fully effective.
 - * When using an EOS R camera, select either [Mode 1] (default factory setting) or [Mode 2] in the [Silent LV shoot.] settings, or select [Enable] in the [Silent shutter] settings.
- When using a tripod, the Image Stabilizer might not be fully effective or it might be better to set the STABILIZER switch to OFF, depending on the type of tripod and where the tripod is located, as well as on the camera's settings such as shutter speed.
- Even with a monopod, the Image Stabilizer will be as effective as during hand-held shooting. However, depending on the shooting conditions, there are cases in which the Image Stabilizer effect may be less effective.

Image Stabilizer

The Image Stabilizer for this lens is suited to hand-held shots in the following conditions.



- In semi-darkened areas such as indoors or outdoors at night.
- In locations where the flash cannot be used, such as art museums and theater stages.
- In situations where your footing is uncertain.
- In situations where fast shutter speed settings cannot be used.



- Panning shots of vehicles, trains, etc.
It compensates for vertical camera shake during panning shots in a horizontal direction, and compensates for horizontal camera shake during panning shots in a vertical direction.

8. Hood

The custom lens hood reduces unwanted light that causes flare and ghosting and protects the front of the lens from rain, snow, and dust.

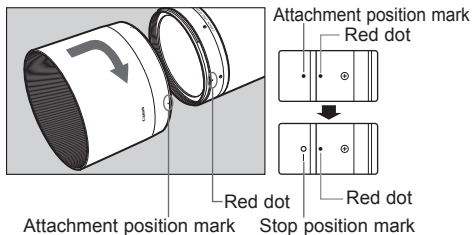

Attaching the Hood

Align the red attachment position mark on the hood with the red dot on the front of the lens, and then turn the hood in the direction of the arrow until you hear a click.

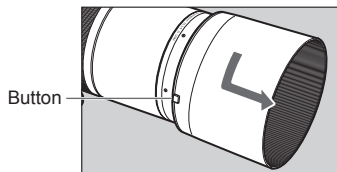

Detaching the Hood

Keep your finger pressed down on the button located on the side of the hood, and then turn the hood in the direction of the arrow until the attachment position mark on the hood is aligned with the red dot on the front of the lens to detach it.

The hood can be reverse-mounted on the lens for storage.

- If the hood is not attached properly, vignetting (darkening of the perimeter of the picture) may occur.
- Grasp and turn the base of the hood when attaching and detaching it. There are cases in which it may become deformed if the hood is turned with it grasped near to the rim.

9. Tripod Mount

A tripod or monopod attaches to the tripod mount on the lens.

Switching the Orientation of the Image

By loosening the orientation locking knob on the tripod mount you can rotate the camera and the lens to switch the image in any orientation (vertical, horizontal, etc.).

Make sure that the orientation locking knob is tightened after setting the camera in place.

-  ● Since this lens has a long focal length and even a slight tilt is noticeable, use the camera's built-in electronic level to correctly create a level view.

10. Extenders (Sold separately)

Use an extender RF1.4x or RF2x to shoot a larger image of a subject. Lens specifications when using an extender are as follows.

RF1.4x		WIDE	TELE
Focal length (mm)		280	1120
Aperture		f/9-45	f/13-72
Angle of view	Horizontal	7°20'	1°50'
	Vertical	4°55'	1°10'
	Diagonal	8°50'	2°10'
Maximum magnification (x)		0.37	0.28

RF2x		WIDE	TELE
Focal length (mm)		400	1600
Aperture		f/13-64	f/18-91
Angle of view	Horizontal	5°10'	1°20'
	Vertical	3°30'	50'
	Diagonal	6°10'	1°30'
Maximum magnification (x)		0.54	0.41



- Attach the extender to the lens, and then attach the lens to the camera. To detach it, reverse the order.
- Extenders cannot be used more than one at a time.
- The available autofocus range for this lens will differ depending on the combination of camera and extender in use.
Please check the Canon website for further details.



- When an extender is attached, the AF speed will become slower to retain proper control.

11. Filters (Sold separately)

You can attach filters (ø95) to the filter mounting thread on the front of the lens.

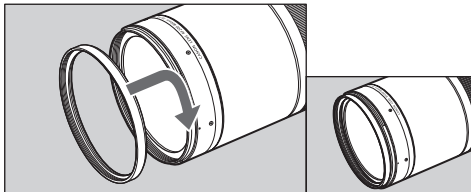

- Only one filter may be attached.
- If you need a polarizing filter, use the Canon Circular Polarizing Filter PL-C B.
- Detach the hood when adjusting the polarizing filter.

Specifications

Focal Length/Aperture	200 - 800mm f/6.3 - 9
Lens Construction	11 groups, 17 elements
Maximum Aperture	f/6.3 - 9
Minimum Aperture	f/32 - 51
Angle of View	Horizontal: 10° - 2°35', Vertical: 7° - 1°40', Diagonal: 12° - 3°05'
Min. Focusing Distance	0.8 m/2.62 ft. (at 200 mm)* ¹
Max. Magnification	0.25x (at 200 mm)
Field of View	Approx. 135 x 90 (at 200 mm) - Approx. 192 x 128 mm (at 550 mm)* ²
Filter Diameter	95 mm
Max. Diameter and Length	Approx. 102.3 x 314.1 mm/40.28 x 123.66 in.
Weight	Approx. 2050 g/72.31 oz.
Hood	ET-101* ³
Lens Cap	E-95* ³
Lens Dust Cap	Lens Dust Cap RF* ³
Case	LZ1438 (sold separately)

*1 Changes according to the focal length. Please refer to the "4. Zooming" page for details.

*2 The field of view at a focal length of 800 mm is approx. 173 x 115 mm.

*3 Included with the lens, but can be purchased separately.

Specifications

- The lens length is measured from the lens mount surface to the front end of the lens.
Add 24.4 mm/0.96 in. when including the lens cap and dust cap.
- The maximum diameter, length and weight listed are for the lens itself only.
- Close-up Lens 250D/500D cannot be attached because there is no size that fits the lens.
- All data listed is measured according to Canon standards.
- Product specifications and appearance are subject to change without notice.

Canon

