



BOSCH

Register your
new device on
MyBosch now and
get free benefits:
[bosch-home.com/
welcome](https://bosch-home.com/welcome)



Washing machine

WGG444E0TH

en Instruction Manual and Installation Instructions

Your new washing machine

You have chosen a Bosch washing machine.

Please take a few minutes to read and become familiar with the advantages of your washing machine.

To meet the high quality demands required by Bosch, every washing machine that leaves our factory is carefully checked to ensure that it functions correctly and is in perfect condition.

For more information on our products, accessories, replacement parts and services, see our website www.bosch-home.com or contact our after-sales service centres.

If the operating and installation instructions describe different models, any differences will be pointed out at the relevant points in the text.



Read these operating and installation instructions before switching on the washing machine.

Display rules

Warning!

This combination of symbol and signal word indicates a possibly dangerous situation. Not heeding the warning can cause death or injuries.

Caution!

This signal word indicates a possibly dangerous situation. Not heeding the caution can cause property and/or environmental damage.

Note/tip

Information about the optimum use of the appliance/any other useful information.

1. 2. 3. / a) b) c)

The steps are represented by numbers or letters.

■ / -

Lists are represented by a small box or a dash.

Contents

	Intended use	4
--	-------------------------------	---

	Safety instructions	5
--	--------------------------------------	---

Children/people/pets	5
Installation	6
Operation	8
Cleaning/Maintenance	10

	Environmental protection	11
--	---	----

Packaging/used appliance	11
Tips on economical use	12

	Positioning and connecting	12
--	---	----

Standard accessories	12
Safety instructions	13
Installation surface	13
Installation on a base or a wooden joist floor	13
Installing the appliance in a kitchenette	14
Removing the transport locks	14
Removing the support struts	15
Hose and cable lengths	15
Water inlet	16
Water outlet	17
Alignment	18
Electrical connection	18
Before washing for the first time	19
Transportation	19

	Getting to know the appliance	21
--	--	----

Appliance	21
Control panel	22
Display panel	23

	Laundry	24
--	--------------------------	----

Protecting your laundry and appliance	24
Sorting laundry	24
Starching	25
Dyeing/bleaching	25

	Detergent	25
---	----------------------------	----

Correct selection of detergent	25
Saving energy and detergent	26

	Overview of programmes	27
---	---	----

Selectable programme	27
--------------------------------	----

	Programme default settings	31
---	---	----

⏸ Temp. °C	31
⌚ Spin	31
🕒 Ready In	31

	Additional programme settings	32
---	--	----

👕 Anti Stain	32
👑 Extra Rinse	32
⊕ Disinfectant	32
🌀 Silent Wash	32
⚙️ SpeedPerfect	32







	Operating the appliance	33
---	--	----

Preparing the appliance	33
Select programme/switch on the appliance	33
Placing laundry into the drum	33
Measure and add detergent and care products	34
Starting the programme	35
Childproof lock	35
Adding/removing laundry	35
Changing the programme	36
Cancel the programme	36
Programme end	36
Removing laundry/switching off the appliance	36

	Appliance settings	37
---	-------------------------------------	----

	Sensors	37
---	--------------------------	----

Unbalanced load detection system	37
--	----

	Cleaning and maintenance . . .	38
	Appliance housing/control panel . . .	38
	Drum	38
	Descaling	38
	Emptying the detergent draw, cleaning the detergent drawer and its housing	38
	Cleaning the measuring aid A for liquid detergent	39
	Drain pump is blocked	40
	The drain hose at the siphon is blocked	41
	Filter in the water supply is blocked	41
	Faults and what to do about them	42
	Emergency release	42
	Information on the display panel . . .	43
	Faults and what to do about them . .	44
	After-sales service	46
	Consumption values	47
	Technical data	48
	Aqua-Stop warranty	48

Intended use

- This appliance is intended for private domestic use only.
- Do not install or operate this appliance anywhere that is liable to experience frost and/or outdoor conditions. There is a risk that the appliance will be damaged if residual water in it freezes. If hoses freeze up, they may crack/burst.
- This appliance must only be used for washing domestic laundry, consisting of machine-washable items and hand-washable woollens (see label on item). Using the appliance for any other purpose is outside of the scope of its intended application and is forbidden.
- This appliance is suitable for operation with mains water and commercially available detergents and care products (must be suitable for use in washing machines).
- This appliance is intended for use up to a maximum height of 4000 metres above sea level.

Before you switch on the appliance:

Check that there is no visible damage to the appliance. Do not operate the appliance if it is damaged. Should you have any problems, please contact your specialist dealer or our customer service.

Read and follow the operating and installation instructions and all other information provided with this appliance.

Retain the documents for subsequent use or for subsequent owners.

Safety instructions

The following safety information and warnings are provided to protect you from injury and to prevent material damage to your surroundings.

It is nevertheless important to take the necessary precautions and to proceed with care when installing, maintaining, cleaning and operating the appliance.

Children/people/pets

Warning **Risk of death!**

Children and other people who are unable to assess the risks involved when using the appliance may injure themselves or may find themselves in life-threatening situations. Therefore please note:

- The appliance may be used by children over the age of 8 years and by persons with reduced physical, sensory or mental capacity or by persons with a lack of experience or knowledge as long as they are supervised or have received instruction on how to use the appliance safely and they have understood the potential risks of using the appliance.
- Children must not play with this appliance.

- Do not allow children to clean or maintain this appliance unsupervised.
- Keep children under 3 years and pets away from this appliance.
- Do not leave the appliance unattended when children or other people who are unable to assess the risks are in the vicinity.

Warning **Risk of death!**

Children may lock themselves inside appliances and find themselves in a life-threatening situation.

- Do not position the appliance behind a door, as this may obstruct the appliance door or prevent it from opening completely.
- Once an appliance has reached the end of its life, pull the mains plug from the socket **before** severing the mains cable, and then destroy the lock on the appliance door.

Warning **Risk of suffocation!**

If allowed to play with the packaging/plastic film or packing components, children may become caught in these or pull them over their heads and suffocate.

Keep packaging, plastic film and packing components away from children.

 **Warning**

Risk of poisoning!

Detergents and care products may result in poisoning if consumed.

If accidentally swallowed, seek medical advice. Keep detergents and care products out of the reach of children.

 **Warning**

Risk of burns!

When washing at high temperatures, the glass in the appliance door becomes hot. Stop children from touching the appliance door when it is hot.

 **Warning**

Eye/skin irritation!

Contact with detergents or care products may cause eye/skin irritation.

Rinse eyes/skin thoroughly if they/it come(s) into contact with detergents or care products. Keep detergents and care products out of the reach of children.

Installation

 **Warning**

**Risk of electric shock/fire/
material damage/damage to
the appliance!**

If the appliance is not installed properly, this may lead to a dangerous situation. Ensure the following:

- The mains voltage on your power socket must match the rated voltage specified on the appliance (identification plate). The connected loads and the required fuse protection are specified on the identification plate.
- The mains plug and the protective contact socket must match and the earthing system must be correctly installed.
- The installation must have an adequate cross section.
- The mains plug must be freely accessible at all times. If this is not possible, in order to comply with the relevant safety regulations, a switch (all pole disconnection) must be built into the permanent installation in accordance with electrical installation regulations.

- If using a residual current circuit breaker, only use one that bears the following mark: . The presence of this mark is the only way to be sure that it fulfils all the applicable regulations.

Warning

Risk of electric shock/fire/material damage/damage to the appliance!

If the appliance's mains cable is altered or damaged, this may result in electric shock, short circuiting or fire due to overheating.

The mains cable must not be kinked, crushed or altered, and must not come into contact with any heat sources.

Warning

Risk of fire/material damage/damage to the appliance!

The use of extension cords or power strips may result in fire due to overheating or short circuiting.

Connect the appliance directly to an earthed socket that has been correctly installed. Do not use extension cords, power strips or multi-way couplers.

Warning

Risk of injury/material damage/damage to the appliance!

- The appliance may vibrate or move when in operation, potentially resulting in injury or material damage. Place the appliance on a clean, even, solid surface and, using a spirit level to guide you, level it with the screw-in feet.
- If you take hold of any of the appliance's protruding parts (e.g. the appliance door) in order to lift or move it, these parts may break off and cause injury. Do not take hold of any of the appliance's protruding parts in order to move the appliance.

Warning

Risk of injury!

- The appliance is very heavy. Lifting it may result in injury. Do not lift the appliance on your own.
- The appliance has sharp edges on which you could cut your hands. Do not take hold of the appliance by its sharp edges. Wear protective gloves to lift it.

- If the hoses and mains cables are not correctly routed, they may constitute a tripping hazard, which may result in injury.
Route hoses and cables such that they do not constitute a tripping hazard.

Caution!

Material damage/damage to the appliance

- If the water pressure is too high or too low, the appliance may not be able to operate properly, and it may also result in material damage or damage to the appliance.
Make sure that the water pressure in the water supply facility is at least 100 kPa (1 bar), and does not exceed 1000 kPa (10 bar).
- If the water hoses are altered or damaged, this may result in material damage or damage to the appliance.
The water hoses must not be kinked, crushed, altered or severed.
- The use of hoses supplied by other brands to connect to the water supply may result in material damage or damage to the appliance.
Use the hoses supplied with the appliance or genuine spare part hoses only.

- The appliance is secured for transportation by transport locking devices. If the transport locking devices are not removed before the appliance is operated, this may result in damage to the appliance.
It is important to completely remove all transport locking devices before using the appliance for the first time.
Make sure that you retain these transport locking devices separately. It is important to refit the transport locking devices if the appliance is to be transported, in order to prevent the appliance from being damaged in transit.

Operation

Warning Risk of explosions/fire!

Laundry that has been pretreated with cleaning agents that contain solvents, e.g. stain remover/cleaning solvent, may cause an explosion in the drum. Rinse the laundry thoroughly with water before washing it in the machine.

Warning Risk of poisoning!

Poisonous fumes may be given off by cleaning agents that contain solvents, e.g. cleaning solvent.
Do not use cleaning agents that contain solvents.

Warning **Risk of injury!**

- If you support your weight/sit on the appliance door when it is open, the appliance may tip over, which may result in injury.
Do not support your weight on the appliance door when it is open.
- If you climb onto the appliance, the worktop may break, which may result in injury.
Do not climb onto the appliance.
- If you reach into the drum while it is still rotating, you risk injuring your hands.
Wait until the drum has stopped rotating.

Warning **Risk of scalding!**

When washing at high temperatures, there is a risk of scalding if you come into contact with hot detergent solution (e.g. when draining hot detergent solution into a washbasin).
Do not reach into the hot detergent solution.

Warning **Eye/skin irritation!**

Detergent and care products may spray out if the detergent drawer is opened while the appliance is in operation. Rinse eyes/skin thoroughly if they/it come(s) into contact with detergents or care products. If accidentally swallowed, seek medical advice.

Caution! **Material damage/damage to the appliance**

- If the amount of laundry in the appliance exceeds its maximum load capacity, it may not be able to operate properly, or this may result in material damage or damage to the appliance.
Do not exceed the maximum load capacity of dry laundry. Make sure you comply with the maximum load capacities specified for each of the programs.
- If you pour the wrong quantity of detergent or cleaning agent into the appliance, this may result in material damage or damage to the appliance.
Use detergents/care products/cleaning agents and softeners in accordance with the manufacturers' instructions.

Cleaning/Maintenance

Warning

Risk of death!

The appliance is powered by electricity. There is a risk of electric shock if you come into contact with live components. Therefore please note:

- Switch off the appliance. Disconnect the appliance from the power supply (pull out the plug).
- Never take hold of the mains plug with wet hands.
- When removing the mains plug from the socket, always take hold of the plug itself and never the mains cable, otherwise this may damage the mains cable.
- Do not make any technical modifications to the appliance or its features.
- Repairs and any other work on the appliance must only be conducted by our customer service or by an electrician. The same applies for replacing the mains cable (when necessary).
- Spare mains cables can be ordered from our customer service.

Warning

Risk of poisoning!

Poisonous fumes may be given off by cleaning agents that contain solvents, e.g. cleaning solvent.

Do not use cleaning agents that contain solvents.

Warning

Risk of electric shock/material damage/damage to the appliance!

If moisture penetrates the appliance, this may cause it to short circuit.

Do not use a pressure washer, steam cleaner, hose or spray gun to clean your appliance.

Warning

Risk of injury/material damage/damage to the appliance!

The use of spare parts and accessories supplied by other brands is dangerous and may result in injury, material damage or damage to the appliance.

For safety reasons, use genuine spare parts and accessories only.

Caution!**Material damage/damage to the appliance**

Cleaning agents and agents for pretreating laundry (e.g. stain removers, prewash sprays, etc.) may cause damage if they come into contact with the surfaces of the appliance. Therefore please note:

- Do not allow these agents to come into contact with the surfaces of the appliance.
- Clean the appliance with nothing but water and a soft, damp cloth.
- Remove any detergent, spray or other residues immediately.



Environmental protection
Packaging/used appliance

Dispose of packaging in an environmentally-responsible manner.

The following Do's and Don'ts provide a framework for the return and recycling of used products when available in your area.

Do's

- Hand over the old/discarded electronic equipment only to authorized collection centers for disposal
- Consult the authorized service center as to whether the Electronic Equipment can be repaired or not, before discarding
- Consult the retailer about appliance take back schemes

Don'ts

- Don't dump the discarded Electronic Equipment in the open or in any land fill site, as this will result in contamination of the soil and the ground water
- Don't dispose of the discarded Electronic Equipment in household bins or Municipal bins
- The product is not meant for re-sale to any unauthorized agencies/scrap dealers
- Don't keep any replaced spare part(s) from the product in an exposed area

Tips on economical use

- Always fill the appliance with the maximum amount of laundry for each programme.
- Wash normally soiled laundry without pretreating.
- For light and normal soiling in laundry, you can save energy and detergent.
- The selectable temperatures apply to the care labels on the textiles. The temperatures in the appliance may deviate from this so that you get the optimum mix of energy-saving and washing results.
- **Low power mode:** If the appliance is not operated for a prolonged period (approx. 5 minutes), the display panel lighting goes out before the programme starts and after the programme has ended, — (indicator lamp of Start/Pause button) flashes. Select any button to activate the display backlighting. Low power mode is not be activated when the programme is running.
- If the laundry will be dried in a dryer, select the spin speed according to the dryer manufacturer's instructions.

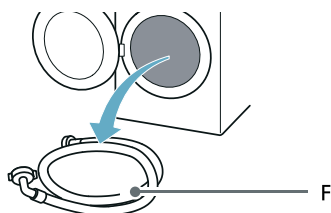
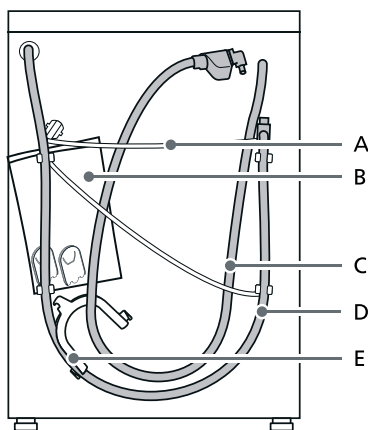

- A Mains lead
- B Bag:
 - Installation and operating instructions
 - Customer Service location directory*
 - Warranty*
 - Supplementary sheet for the installation and operating instructions*
 - Cover caps for openings after the transport braces have been removed
 - Home Connect Installation Guides*
- C Water inlet hose on aquaStop models
- D Water outlet hose
- E Elbow for securing the water outlet hose*
- F Cold water inlet hose on Standard/Aqua-Secure models
- * Depending on the model

Positioning and connecting

Standard accessories

Note: Check the appliance for transport damage. Never use a damaged appliance. If you have any complaints, contact the dealer from whom you purchased the appliance or our Customer Service.

In addition, a hose clamp (24 - 40 mm diameter, available from specialist retailers) is required to connect the water outlet hose to a siphon.

Useful tool

- Spirit level for aligning
- Wrench with:
 - WAF13 for loosening the transport braces and
 - WAF17 for aligning the appliance feet

Safety instructions

Warning

Risk of injury!

- The appliance is very heavy. Be careful when lifting/transporting the appliance.
- When the appliance is lifted by its protruding parts (e.g. the appliance door), the components may break off and cause injuries. Do not lift the appliance by protruding parts.
- If the hose and mains cables are not routed properly, there is a risk of tripping and injury. Lay hoses and cables in such a way that there is no risk of tripping.

Caution!

Damage to the appliance

Frozen hoses may rip/burst. Do not install the appliance in areas exposed to frost or outdoors.

Caution!

Water damage

The connection points for the water supply hose and water drain hose are under high water pressure. To prevent leaks and water damage, you must follow the instructions in this section.

Notes

- In addition to the safety information listed here, the local water and electricity supplier may have special requirements.
- If in doubt, have the appliance connected by a specialist.

Installation surface

Note: The appliance must be stable aligned so that it does not move around.

- The installation surface must be firm and level.
- Soft floors/floor coverings are not suitable.

Installation on a base or a wooden joist floor

Caution!

Damage to the appliance

The appliance may "wander" and tip/topple from the base when spinning. The feet of the appliance must be secured with holding brackets. Order no. WMZ 2200, WX 975600, CZ 110600, Z 7080X0.

Note: On wooden joist floors, install the appliance:

- In a corner, if possible,
- On a water-resistant wooden board (min. 30 mm thick) which is screwed tightly to the floor.

Installing the appliance in a kitchenette

Warning **Risk of death!**

There is a risk of electric shock if you touch live components.
Do not remove the appliance covering plate.

Notes

- Recess width of 60 cm required.
- Only install the appliance underneath a continuous worktop that is securely connected to adjacent cabinets.

Removing the transport locks

Caution! **Damage to the appliance**

- The appliance is secured for transportation using transport locks. If the transport locks are not removed, the appliance may become damaged when it is operated. Before using the appliance for the first time, make sure that you completely remove all four transport locks. Keep the locks in a safe place.
- To prevent transport damage from occurring if the appliance is moved at a later date, you must refit the transport locks before transporting the appliance.

Note: Keep the screws and sleeves in a safe place.

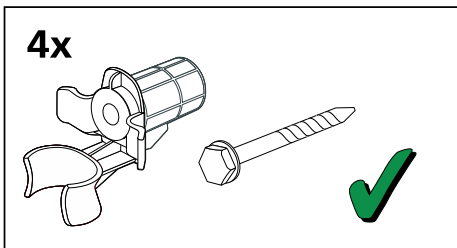

1. Take the hoses out of the holders.

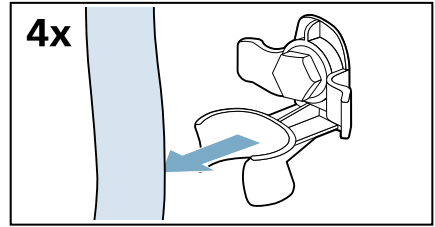

2. Unscrew and remove all four transport brace screws.

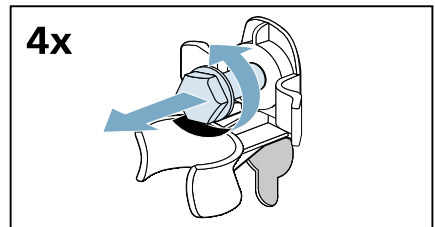

- a) Remove the mains cable from the holders.

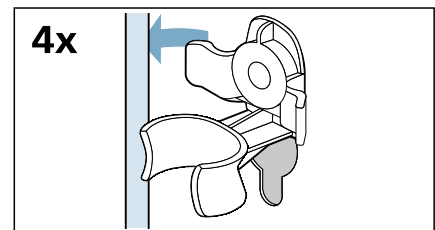

- b) Remove the sleeves.

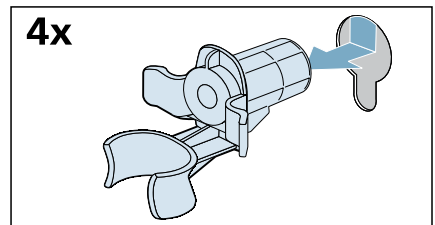

3. Fit the covers.

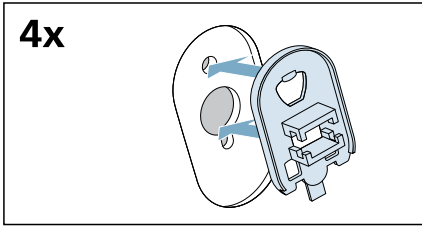

4. Lock the covers firmly in place by applying pressure to the snap-in hooks.

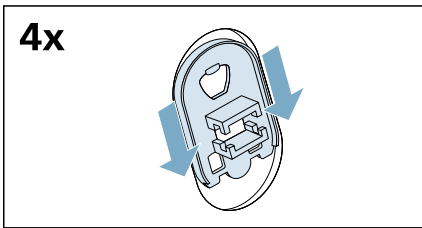

Removing the support struts

1. Unscrew and remove all screws in the vertical transport struts.

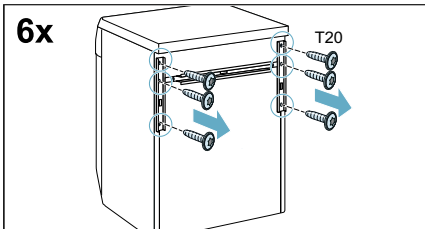

2. Remove the transport struts.

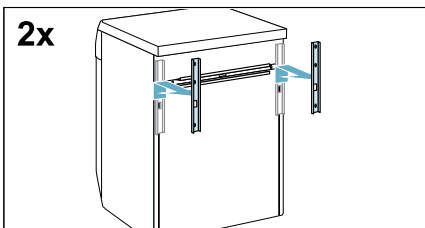

3. Undo and remove the screws on the horizontal transport strut.

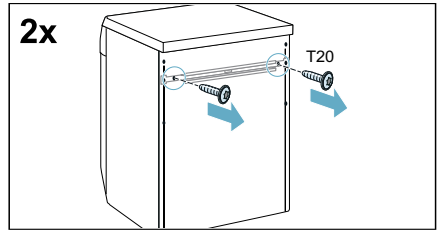

4. Remove the transport strut.

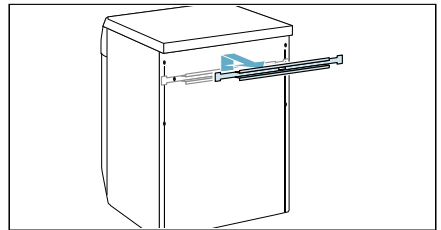

Hose and cable lengths

Connection on left side

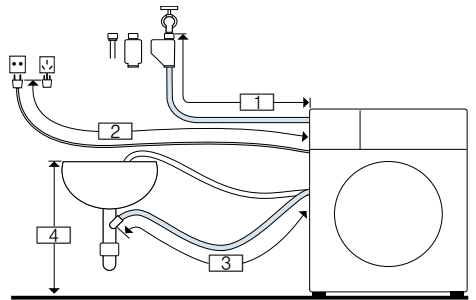

- 1 ~ 135 cm
- 2 ~ 100 cm
- 3 ~ 95 cm
- 4 0 cm ~ 100 cm

or

Connection on right side

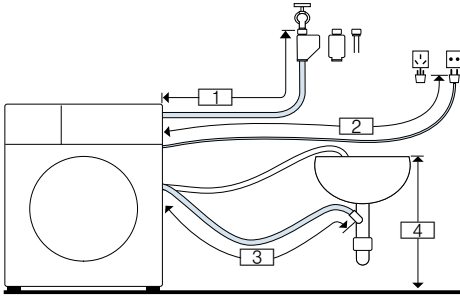

- 1 ~ 90 cm
- 2 ~ 145 cm
- 3 ~ 140 cm
- 4 0 cm ~ 100 cm

Note: If the supply hose is too short for your connection, you can order an extension from the after-sales service.

Water inlet

Warning **Risk of death!**

There is a risk of electric shock if you touch live components. Do not immerse the Aqua-Stop safety valve* in water (it contains an electric valve).

* Depending on the model

Observe the following when connecting the appliance:

Notes

- Only operate the appliance using cold mains water.
- Do not connect the appliance to the mixer tap of an unpressurised hot-water boiler.
- Do not use a used supply hose. Only use the supply hose supplied or one that was purchased from an authorised specialist retailer.

- Do not bend, squash, modify or cut through the water supply hose (otherwise its strength is no longer guaranteed).
- Only tighten the screw connections by hand. If the screw connections are tightened too much with a tool (pliers), the thread may be damaged.

Optimum water pressure in the supply network

At least 100 kPa (1 bar)

Maximum 1000 kPa (10 bar)

When the tap is open, the water flow is at least 8 l/min.

If the water pressure is higher than this, a pressure-reducing valve must be installed.

Connection

1. Connect the water supply hose to the water tap ($\frac{3}{4}$ " = 26.4 mm) and to the appliance:
 - Model: **Standard**

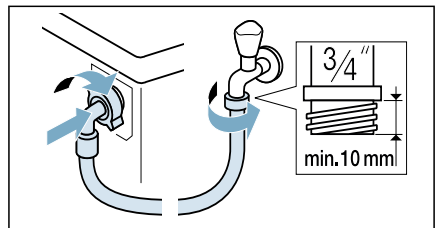

- Model: **Aqua-Secure**

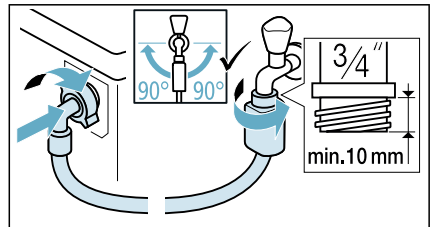

– Model: **Aqua-Stop**

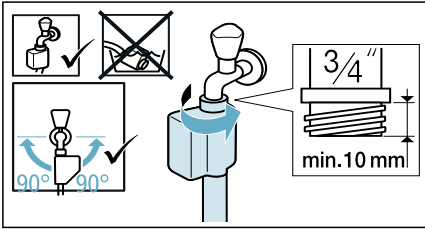

Tip: Connect also an external water filter (depending on the model) between water supply hose and tap. The filter filters dirt particles out of the water.

Water filter must be cleaned regularly to remove contaminants. This will prevent blockages. See also → separate installation and cleaning instruction for water filter.

2. Open the water tap carefully, checking the leak tightness of the connection points. The screw connection is under mains water pressure.

Water outlet

Warning **Risk of scalding!**

When you are washing at high temperatures, there is a risk of scalding if you come into contact with hot water (e.g. when draining hot water into a washbasin).
Do not reach into the hot water.

Caution! **Water damage**

When water is being pumped away, the outlet hose is under water pressure and may slip out of the wash basin or connection point.
Secure the drain hose so that it cannot slip out.

Caution! **Damage to the appliance/fabrics**

If the end of the drain hose is immersed in the drained water, water may be sucked back into the appliance and may damage the appliance/fabrics.
Make sure that:

- The plug does not block drainage from the washbasin.
- The end of the drain hose is not immersed in the drained water.
- The water drains away quickly enough.

Note: Do not kink the water drain hose or put strain on it lengthways.

Connection

■ **Drainage into a siphon**

The connection point must be secured using a hose clamp with a diameter of 24 - 40 mm (available from specialist dealers).

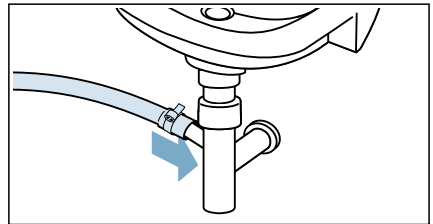

■ **Drainage into a washbasin**

Secure the outlet hose so that it cannot slip out.
Elbow available from after-sales service:
Individual part number 00655300

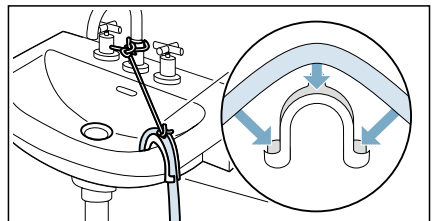

- **Drainage into a plastic pipe with rubber bushing or into a drainage pit**

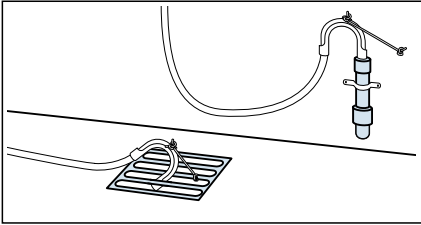

Note: The plastic pipe is not standard accessory, available from specialist dealers.

Alignment

Level the appliance using a spirit level. Incorrect levelling may result in intense noise, vibrations and "wandering".

1. Loosen the lock nuts using a wrench, by turning it in a clockwise direction.

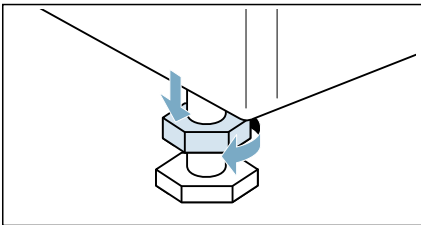

2. Check the alignment of the appliance with a spirit level, and adjust it if necessary. Change the height by turning the appliance feet. All four appliance feet must stand firmly on the ground.

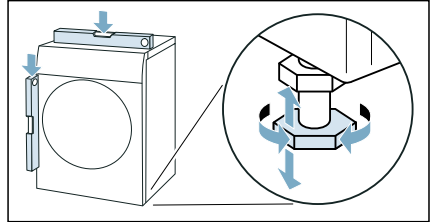

3. Tighten the lock nut against the housing. In doing so, hold the foot tight and do not adjust its height. The lock nuts on all four appliance feet must be screwed tightly against the housing.

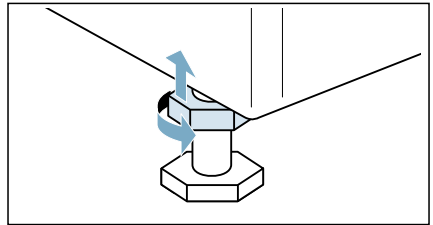

Electrical connection

⚠ Warning **Risk of death!**

There is a risk of electric shock if you touch live components.

- Never touch or hold the mains plug with wet hands.
- Only pull out the mains cable by the plug and never by the cable, as this could damage it.

Observe the following information and ensure that:

Notes

- The mains voltage and voltage indicated on the appliance (rating plate) are the same. The connected load and fuse required are specified on the rating plate.
- The appliance is only connected to an alternating current via a properly installed earthed socket.
- The mains plug fits the socket.
- The earthing system is properly installed.
- The mains cable is only replaced by a qualified electrician (if this is necessary). Replacement mains cables are available from the after-sales service.
- No multiple plugs/couplings or extension cables are used.
- If an earth-leakage circuit breaker is used, only a type which displays this symbol is used: . Only this symbol guarantees compliance with the currently applicable regulations.
- The mains plug can be accessed at all times.
- The mains cable is not bent, squashed, modified, cut through, or in contact with heat sources.

Before washing for the first time

The appliance was inspected thoroughly before leaving the factory. To remove any residual test water, run the **Drum Clean** programme the first time **without** laundry.

Note:

- The appliance must have been installed and connected properly. → "Positioning and connecting" on page 12
- Never switch on a damaged appliance.

1. Insert mains plug.
 2. Turn the water tap on.
 3. Close the door. Do not load any laundry.
 4. Select the **Drum Clean 90 °C** programme.
 5. Open the detergent drawer.
 6. Pour approx. 1 litre of water into dispenser II.
 7. Add standard detergent to dispenser II according to manufacturer's instructions for light soiling.

Note: To prevent frothing, use only half the recommended amount of detergent. Do not use any woollens or mild detergents.
 8. Close the detergent drawer.
 9. Select **Start/Pause** ▷||.
 10. When the programme ends, turn the programme selector to **Off**.
- Your appliance is now ready for use.**

Transportation

e.g. when moving home

Preparatory work:

1. Turn off the water tap.
2. Reduce the water pressure in the supply hose. → Page 41
3. Drain any residual water. → Page 40
4. Disconnect the appliance from the mains.
5. Remove the hoses.
6. Empty the dispensers.

Caution!

Risk of damage to the appliance caused by detergent/fabric softener leaking from the dispensers

Leaking detergent/fabric softener can prevent the appliance from working correctly, e.g. due to damage to the electronics. Empty the dispensers before transporting the appliance.

Installing the transport locks:

1. Remove the covers and keep them in a safe place.

Note: Use a screwdriver if necessary.

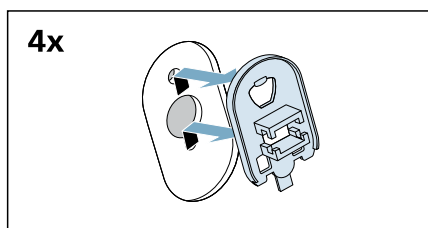
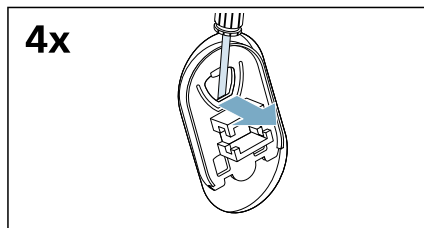

2. Insert all four sleeves.

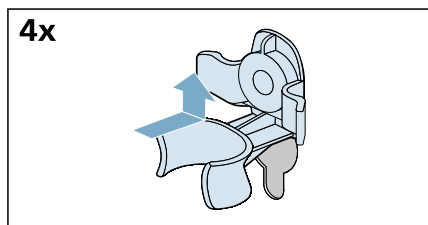

- a) Clip the mains cable securely in the holders.

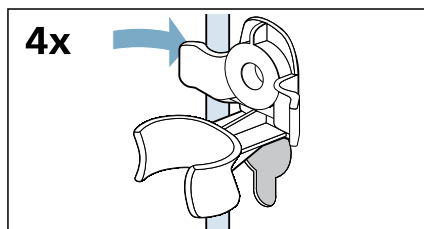

- b) Insert and tighten the screws.

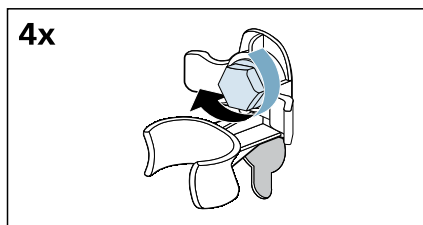

- c) Clip the hoses securely in the holders.

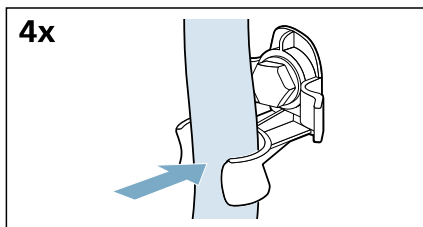

Before switching on the appliance again:

Notes

- The support struts **must** be removed.
→ "Removing the support struts" on page 15
- The transport braces **must** be removed.
→ "Removing the transport locks" on page 14
- Pour approx. 1 litre of water into dispenser II, select the **Spin** programme and start. This will prevent detergent from flowing straight into the drain during the next wash.

Getting to know the appliance

Appliance

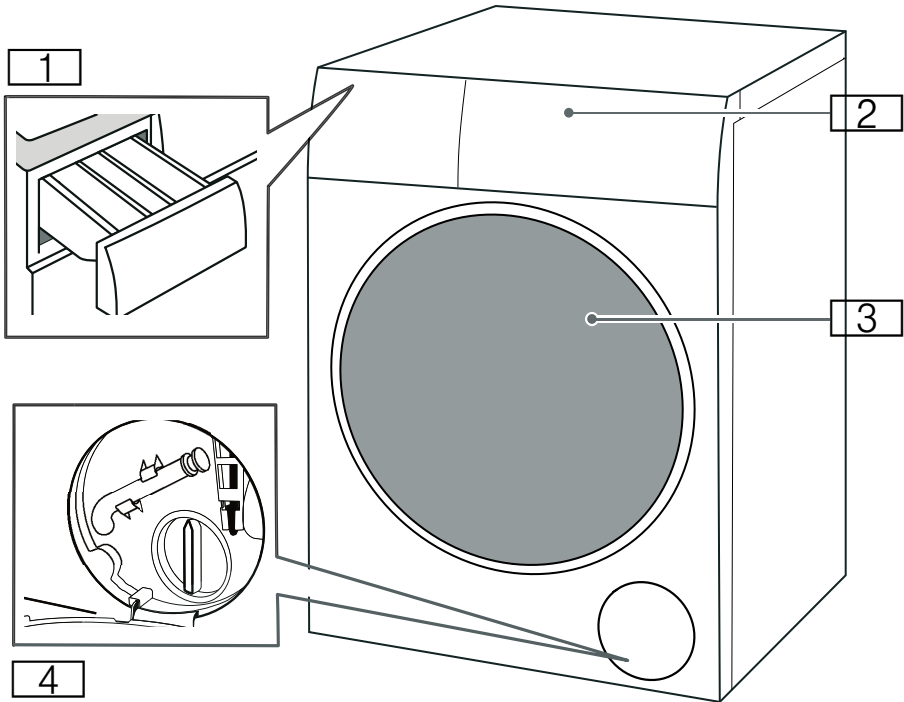

- 1** Detergent drawer
- 2** Control panel
- 3** Loading door
- 4** Service flap

Control panel

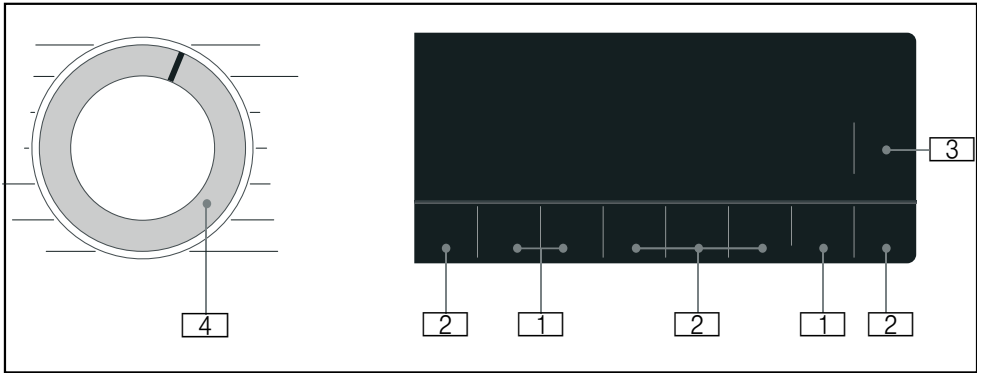

- 1** Programme default settings can be changed.
Overview of all programme default settings → *Page 31*
- 2** Additional programme settings can be selected.
Overview of all additional programme settings
→ *Page 32*
- 3** Start/Pause  button for starting, interrupting, (e.g. adding laundry) and cancelling a programme.
- 4** Programme selector for selecting the programme and for switching the appliance on and off.

Display panel

Programme default settings

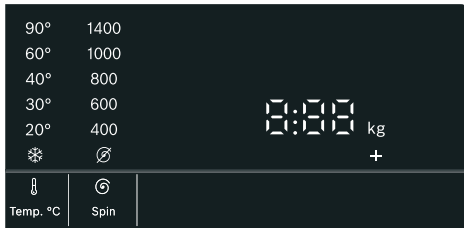

Display	Setting	Description
✳ - 90°	Temperature	Temperature that can be set in °C ✳ = cold
⌀ - 1400*	Spin speed	Spin speed in rpm (revolutions per minute) ⌀ = No spin
2:30*	Programme remaining time	Programme remaining time depends on the programme selection in h:min (hours:minutes)
0.5 - 24 h	Finish in time	Programme ends after ... h (h = hours)
9.0* kg	Maximum load for washing	Recommended load in kg
* Depending on the selected model and programme.		

Additional programme settings

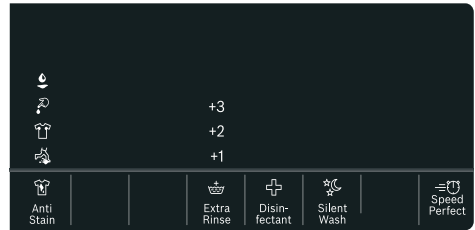

Display	Setting
☹/🌀/👕/🧼	Anti Stain
+1/+2/+3	Extra Rinse
+	Disinfectant
🌙	Silent Wash
≡🌀	SpeedPerfect

Status indicators for the programme progress (programme sequence)

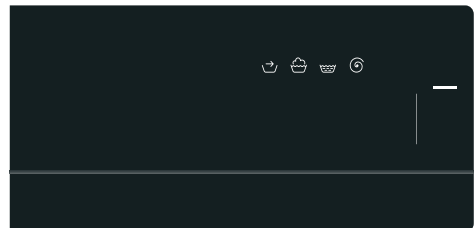

Display	Setting
—	Start/Pause button
👕	Pretreatment
🧼	Wash
🪣	Rinse
🌀	Spin/Drain
End	Programme end



Laundry

Protecting your laundry and appliance

Caution!

Damage to the appliance/textiles

Foreign objects (e.g. coins, paper clips, needles, nails) may damage the washing or components of the appliance.

The following instructions must be observed when preparing your laundry:

- Always follow the manufacturer's instructions when dosing all detergents, cleaning aids, care products and cleaning agents.
- Do not exceed maximum load. Overfilling will impair the washing result.
- Keep detergents and agents for the pretreatment of laundry (e.g. stain remover, prewash sprays, etc.) away from the surfaces of the appliance. Using a damp cloth, immediately remove any fine spray residue and other residue or droplets.
- Empty any pockets. Remove any foreign objects.
- Remove metal parts (paper clips, etc.).
- Trousers, knitwear and knitted textiles, e.g. jersey garments, T-shirts or sweatshirts, should be turned inside out.
- Ensure that underwired bras are appliance-washable.
- Wash delicates in a net or bag (tights, underwired bras, etc.).
- Close zips, button up covers.
- Brush sand out of pockets and collars.
- Remove curtain fittings or place in a net/bag.

Sorting laundry

Sort your laundry according to the care instructions and manufacturer's information on the care labels, depending on:

- Type of fabric/fibre
- Colour
 - Note:** Laundry may discolour. Wash white and coloured items separately. Wash new coloured items separately the first time you wash them.
- Soiling
 - Wash laundry with the same level of soiling together.
 - **Light:** Do not need to pretreat, select the **SpeedPerfect** setting if necessary.
 - **Normal**
 - **Heavy:** Load less laundry, need to pretreat or soak laundry firstly.
 - **Stains:** Remove/pretreat stains while they are fresh. First dab with soapy water; do not rub. Then wash the items of laundry with the appropriate programme. Stubborn or dried-in stains can sometimes only be removed by washing several times.
- Symbols on the care labels
 - Suitable for normal washing process; e.g. Cottons programme
 - A gentle washing process is required; e.g. Synthetics programme
 - An especially gentle washing process is required; e.g. Delicates/Silk programme
 - Suitable for washing by hand; e.g. Wool programme
 - Do not machine wash.

Starching

Note: Laundry should not be treated with fabric softener.

1. Switch on the appliance.
2. Select the **Rinse** programme.
3. Measure starch into dispenser I in accordance with the manufacturer's instructions (clean first if necessary).
4. Touch the **Start/Pause**  button.

Dyeing/bleaching

Dye should only be used in normal household quantities. Salt may damage stainless steel. Always follow the dye manufacturer's instructions.

Do **not** use the appliance to bleach clothes.



Detergent

Correct selection of detergent

The care label is crucial to ensure correct detergent selection, temperature and laundry treatment.

- **Standard detergent with optical brighteners**
suitable for heat-resistant white washing made from linen or cotton
Programme: Cottons/
cold – max. 90 °C
- **Detergent for colours without bleach or optical brighteners**
suitable for coloured washing made from linen or cotton
Programme: Cottons/
cold – max. 60 °C
- **Detergent for colours/delicates without optical brighteners**
suitable for coloured laundry made from easy-care fibres, synthetic fibres
Programme: Synthetics/
cold – max. 60 °C
- **Detergent for delicates**
suitable for delicate, fine fabrics, silk or viscose
Programme: Delicates/Silk/
cold – max. 40 °C
- **Detergent for woollens**
suitable for woollen fabrics
Programme:  Wool/ cold – max. 40 °C

Saving energy and detergent

















For light and normal soiling, you can save energy (lower washing temperature) and detergent.

Saving	Soiling/note
<p>Reduced temperature and detergent quantity as per the recommended dosage</p>  <p>Temperature as per the care label and detergent quantity as per the recommended dosage for heavy soiling</p>	<p>Light No visible dirt or stains. Clothing has taken on some body odour, e.g.:</p> <ul style="list-style-type: none">■ Light summer/sports clothing (worn for a few hours)■ T-shirts, shirts, blouses (worn for up to one day)■ Guest bed linen and hand towels (used for one day)
	<p>Normal Visible dirt or a few light stains, e.g.:</p> <ul style="list-style-type: none">■ T-shirts, shirts, blouses (sweat soaked, worn a few times)■ Towels, bedding (used for up to one week)
	<p>Heavy Dirt and/or stains clearly visible, e.g. tea towels, baby items, work clothing</p>

Note: When measuring the amount of all detergents/additives/care products and cleaning agents, please always check the manufacturer's instructions and information.

Overview of programmes

Selectable programme

Programme/Type of washing	Options/Information
Name of the programme Brief explanation of the programme and for which fabrics it is suitable.	Max. load as kg depending on the model and the programme selectable temperature* as °C selectable spin speed* in rpm possible additional programme settings* softener
Cottons Hard-wearing fabrics, heat-resistant fabrics made of cotton or linen.	9.0 kg/5.0** kg * - 90 °C 400 - 1400 rpm  Anti Stain,  Extra Rinse,  Disinfectant,  Silent Wash,  SpeedPerfect possible
Mix Load Mixed load of cottons and synthetic fabrics.	4.0 kg * - 60 °C 400 - 1400 rpm  Anti Stain,  Extra Rinse,  Disinfectant,  Silent Wash,  SpeedPerfect possible
Synthetics Textiles made of synthetic materials or blended fabrics.	4.0 kg * - 60 °C 400 - 1000 rpm  Anti Stain,  Extra Rinse,  Disinfectant,  Silent Wash,  SpeedPerfect possible
* Depending on the model and the programme. ** Reduced load with  SpeedPerfect additional programme setting.	

Programme/Type of washing	Options/Information
Delicates/Silk For delicate, washable fabrics, e.g. made of silk, satin, synthetic fibres or blends (e.g. silk blouses, silk scarves).	2.0 kg ❄ - 40 °C 🌀 - 800 rpm 🧺 Anti Stain, 🏰 Extra Rinse, 🌙 Silent Wash possible
 Wool Hand- or appliance-washable fabrics that are made of wool or contain wool; particularly gentle wash programme to prevent laundry from shrinking, with longer pauses in the programme (during which the items rest in the water).	2.0 kg ❄ - 40 °C 🌀 - 800 rpm 🌙 Silent Wash possible
Rinse For rinsing with a subsequent spin cycle.	- - 🌀 - 1400 rpm 🏰 Extra Rinse possible
Spin For spinning with a selectable spin speed and subsequent draining. If you have selected 🌀, the water is only drained after rinse process, no spin cycle.	- - 🌀 - 1400 rpm - not possible
Drum Clean Programme for cleaning and caring for the drum and the outer tub, e.g. before running the first wash cycle, if washing frequently at a low temperature (40 °C or lower) or if an odour has developed after a prolonged period of non-use. The symbol 🧼 (memory function, drum care) flashes if you have not used any programme at a temperature of 60 °C or higher for an extended period.	0.0 kg ❄, 40°C, 90 °C 1000 rpm 🌙 Silent Wash not possible
Notes <ul style="list-style-type: none"> ■ Run programme without laundry. ■ Switching the drum care information signal on/off. → <i>Page 37</i> ■ Always follow the manufacturer's instructions when dosing the detergent. 	
* Depending on the model and the programme. ** Reduced load with 🔄 SpeedPerfect additional programme setting.	

Programme/Type of washing	Options/Information
<p>Downs Clothes</p> <p>Appliance-washable fabrics stuffed with down, such as pillows and duvets; also suitable for items stuffed with synthetic fibres</p>	<p>2.0 kg</p> <p>❄ - 60 °C</p> <p>400 - 1000 rpm</p> <p>👑 Extra Rinse</p> <p>not possible</p>
<p>Jeans</p> <p>Programme suitable for washing Jeans and other dark color textiles made of cotton or synthetic textiles.</p>	<p>4.0 kg</p> <p>❄ - 40 °C</p> <p>400 - 1000 rpm</p> <p>👕 Anti Stain, 👑 Extra Rinse, 🌙 Silent Wash, ⚡ SpeedPerfect</p> <p>possible</p>
<p>Bed Linen</p> <p>For cleaning bedding made from cotton and linen fabrics that has particularly strict hygienic requirements (e.g. for people with allergies).</p>	<p>4.0 kg</p> <p>❄ - 90 °C</p> <p>400 - 1400 rpm</p> <p>👕 Anti Stain, 👑 Extra Rinse, ⚡ Disinfectant, 🌙 Silent Wash, ⚡ SpeedPerfect</p> <p>possible</p>
<p>Sensitive</p> <p>Hard-wearing fabrics made of cotton or linen.</p> <p>Note: Particularly suited to washing items that need to be hygienically clean and especially kind to sensitive skin thanks to the longer wash cycle at a defined temperature, higher water level and longer spin cycle.</p>	<p>6.5 kg</p> <p>❄ - 60 °C</p> <p>400 - 1400 rpm</p> <p>👕 Anti Stain, 👑 Extra Rinse, ⚡ Disinfectant, 🌙 Silent Wash, ⚡ SpeedPerfect</p> <p>possible</p>
<p>Outdoor/Waterproofing</p> <p>weatherproof and outdoor clothing with membrane coating and water-resistant textiles.</p> <p>Note: Before washing, clean the detergent drawer thoroughly (all compartments) to remove fabric-softener residue, and put the waterproofing agent into dispenser ☒.</p>	<p>1.0 kg</p> <p>❄ - 40 °C</p> <p>400 - 800 rpm</p> <p>👕 Anti Stain, 👑 Extra Rinse, 🌙 Silent Wash</p> <p>not possible</p>
<p>* Depending on the model and the programme.</p> <p>** Reduced load with ⚡ SpeedPerfect additional programme setting.</p>	

Programme/Type of washing	Options/Information
<p>Quick 15 min</p> <p>Extra-short programme of approx. 15 minutes, suitable for small items of lightly soiled laundry.</p>	<p>2.0 kg</p> <p>* - 40 °C</p> <p>400 - 1000 rpm</p> <p>👑 Extra Rinse, 🌬️ Silent Wash possible</p>
<p>* Depending on the model and the programme.</p> <p>** Reduced load with 🔄 SpeedPerfect additional programme setting.</p>	

P+ Programme default settings

You can change the default settings for selected programmes. The settings can be changed even while the selected programme is running. The effects depending on the progress of the programme.

Temp. °C

Before and after the programme starts, you can change the temperature setting, depending on what stage the programme is in, by adjusting the desired temperature on the display.

The maximum temperature that can be set depends on the programme that has been selected.

Spin

Depending on what stage the programme is in, you can change the spin speed (in rpm; revolutions per minute) before and during the programme.

setting  = "No spin". The rinsing water is drained but there is no final spin. The laundry stays wet inside the drum, e.g. for items that should not be spun.



You can select "No spin" to prevent creasing if the laundry will not be taken out of the appliance immediately after the programme has ended.

The maximum speed that can be set depending on the model and the programme that has been selected.

Ready In



Before starting the programme, you can preselect the programme end ("Finish in" time) in 0.5h (h = hour) increments (between "minimum selectable ending time" and 9.5h) or 1 hour increments (between 10h and 24h) up to a maximum of 24 hours.

To do this:

1. Select a programme (except **myTime*** programme). The programme duration is displayed for the selected programme, e.g. **2:30** (hours:minutes).
2. Select the  **Ready In** button repeatedly until the required number of hours is displayed.
3. Select the **Start/Pause**  button. The programme starts. The selected number of hours (e.g. **8h**) is shown in the display panel and counts down until the programme starts. The duration of the programme is then displayed.

Note: The length of the programme is automatically adjusted when the programme is running. Changes to the programme default settings or additional programme settings may also change the programme duration.

After starting the programme (if a "Finish in" time has been selected and the programme has not yet started), you can change the preselected number of hours as follows:

1. Select the **Start/Pause**  button.
2. Select the  **Ready In** button repeatedly to change the number of hours.
3. Select the **Start/Pause**  button.

* Depending on the model

P+ Additional programme settings

Note: You can find possible additional programme settings in the overview; these differ depending on the model.

By selecting additional programme settings, you can better adapt the washing process to your items of laundry.





The settings can be selected or deselected depending on the progress of the programme.

The button indicator lamps light up if a setting is activated.

The settings are not retained after the appliance is switched off.

Anti Stain

Types of stain that can be selected:

-  Oil
-  Blood
-  Sweat
-  Mud

Do not let stains dry. Remove solid substances beforehand.

Select a programme with a stain type:

1. Arrange items of washing as usual.
2. Select a programme.
3. Select a stain type (depending on the selected programme).
4. Start the programme.

The appliance adjusts the average washing temperature, drum movement and soaking time to the specific type of stain. Hot or cold water, gentle or intensive washing and long or short soaking ensure that the wash programme sequence is specially adapted to each type of stain. This makes sure that stains are treated in the best possible way.

Extra Rinse

Settings that can be selected:

- +1 **+ 1 rinse cycle**
- +2 **+ 2 rinse cycles**
- +3 **+ 3 rinse cycles**

Additional rinse cycles for particularly sensitive skin and/or for areas with very soft water.

Longer programme duration, due to additional rinse cycle.

The number of rinse cycles that the programme actually runs depends on the number that is set as a basic setting for the programme.

Disinfectant

For washing with special disinfectants in order to kill bacteria and thereby meet high standards of hygiene.

Note: Add disinfectant to dispenser I.

Silent Wash

Function designed for noise reduction. Washing process noise will be reduced, and ending signal will be switched off.

Note: If  **Silent Wash** is selected, remaining moisture of the laundry will be slightly increased. The spin result may not be satisfying. Before hanging you can select **Spin** programme to further reduce moisture.

SpeedPerfect

Washing in a shorter time while achieving a washing result that is consistent with the normal performance.

Touch  **SpeedPerfect** to activate or deactivate it.

Note: With the  **SpeedPerfect** additional programme setting activated, the maximum load of washing will be reduced.

Operating the appliance

Preparing the appliance

The appliance was tested before delivery. To remove residual water from the test procedure, the first wash cycle should be run without laundry using the **Drum Clean** programme.

→ "Before washing for the first time" on page 19

Notes

- Never switch on a damaged appliance!
- Inform customer service!

1. Insert mains plug.



Warning

Risk of death from electric shock!

Risk of death if live parts are touched.

- Never pull out the mains plug by tugging the power cord.
- Insert/pull out the mains plug with dry hands only.

2. Turn the water tap on.

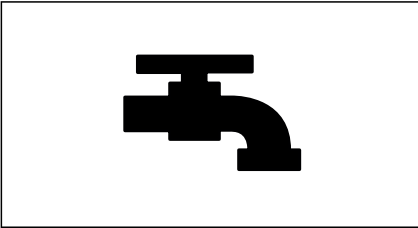

3. Open the appliance door.

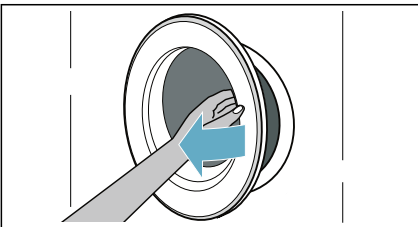

Select programme/switch on the appliance

Note: If you have activated the childproof lock, you must first deactivate it before you can set a programme.

Use the programme selector to select the required programme. The programme selector can be rotated in either direction.

The appliance is switched on.

The **programme default settings** for the selected programme alternately appear in the display panel:

- The maximum load and
- the duration of the programme and
- ...

Placing laundry into the drum

Insert the laundry.

Close the door.

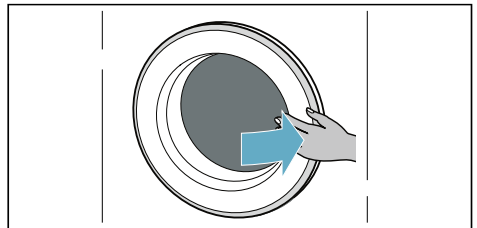
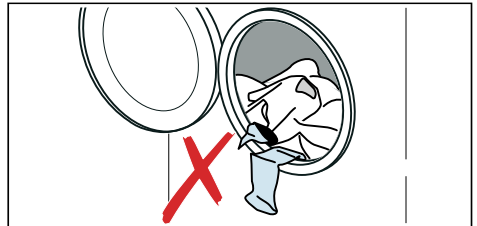

Notes

- Unfold and load presorted items of laundry. Mix large and small items. Washing items of different size distribute themselves better during the spin cycle. Individual items of washing may cause an unbalanced load.
- Observe the maximum specified load. Overfilling adversely affects the washing result and promotes creasing. Make sure that no items of laundry are trapped between the door and the rubber seal, and close the door.

Measure and add detergent and care products

Caution!

Damage to the appliance

Detergents and agents for the pretreatment of laundry (e.g. stain remover, prewash sprays, etc.) may damage the surfaces of the appliance. Keep these agents away from the surfaces of the appliance. Using a damp cloth, immediately remove any fine spray residue and other residue/droplets.

Dosing

Dose the detergents and care products according to:

- water hardness (ask your water supply company),
- the manufacturer's specifications on the packaging,
- the amount of laundry,
- soiling.

Filling the dispensers

1. Pull out the detergent drawer.

Warning Eye / skin irritation!

If the detergent drawer is opened while the appliance is running, detergent/care product may run out. Carefully open the drawer.

If detergent/care product comes into contact with eyes or skin, rinse thoroughly.

If accidentally swallowed, seek medical advice.

2. Pour in detergent and/or cleaning product.

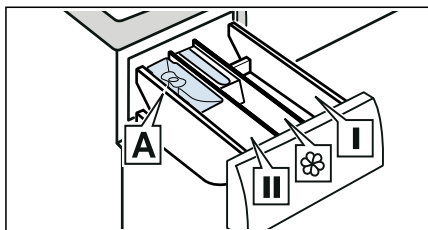

- | | |
|---|--|
| Dispenser I | Detergent for pretreat and clothing disinfectant. (only for the appliance with pretreatment and disinfectant function) |
| Dispenser  | Softener, starch. Do not exceed the maximum load. |
| Dispenser II | Detergent for main wash, water softener, bleach, stain remover. |
| Dispenser A* | For dosing liquid detergent. |

*depending on the model

Notes

- Always follow the manufacturer's instructions when dosing all detergents, cleaning aids, care products and cleaning agents.
- Dilute viscous fabric softener and fabric conditioner with water. This will prevent blockages.

- Be careful when opening the detergent drawer while the appliance is running.

Measuring aid A* for liquid detergent

*depending on the model

Position the measuring aid A for measuring the correct amount of liquid detergent:

1. Pull out the detergent drawer. Insert the liquid detergent container into dispenser **II** for main wash.

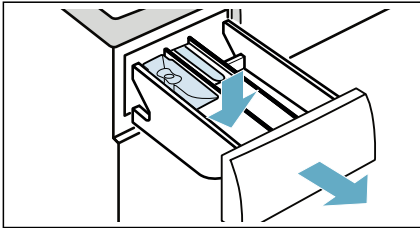

2. Pour liquid detergent into liquid detergent container and do not exceed the Maximum mark.
3. Close the detergent drawer.

Note: Do not use the viscous liquid detergent.

Starting the programme

Touch and hold **Start/Pause** ▷||| button for 1~2 seconds, then release the button. The programme starts and the appliance door is locked.



The **Ready In** is shown in the display panel and counts down until the programme starts. After the programme has started, the programme duration is displayed. And the symbols for the programme progress are lighting up.

Childproof lock

You can lock the appliance to prevent the settings you have set from being changed inadvertently. To do this, activate the childproof lock.

To activate the childproof lock:

After the programme starts, Touch and hold the **Silent Wash** and **Ready in** buttons for 3 seconds. The symbol  lights up in the display panel.

-  lights up: The childproof lock is activated.
-  flashes: If the programme and programme settings are adjusted while childproof lock is activated.

Note: When the programme ends, **End** is displayed. The door is unlocked.  symbol remain on to remind you to deactivate the childproof lock.

To deactivate the childproof lock:



Touch and hold the **Silent Wash** and **Ready in** buttons until the symbol  disappears.

Adding/removing laundry

After starting the programme, you can add or remove laundry if necessary.

Touch the **Start/Pause** ▷||| button. The appliance checks whether reloading is possible.

If the following appears on the display panel:

- The symbol  disappears, reloading is possible.
- The symbol  lights up, reloading is not possible.

To continue the programme, touch the Start/Pause ▷||| button. The programme continues automatically.

Notes

- Do not leave the door open for too long when adding laundry as water from the laundry may leak out.
- For safety reasons, the door remains locked when the water level or temperature is high, or while the drum is turning, and it is not possible to add laundry during this time.

Changing the programme

If you have started the wrong programme by mistake, you can change the programme as follows:

1. Touch the **Start/Pause** ▷||| button.
2. Select another programme.
3. And touch the **Start/Pause** ▷||| button again. The new programme starts from the beginning.

Cancel the programme

For programmes at high temperatures:

1. Touch the **Start/Pause** ▷||| button.
2. To cool down laundry: Select **Rinse**.
3. And touch the **Start/Pause** ▷||| button again.

For programmes at low temperatures:

1. Touch the **Start/Pause** ▷||| button.
2. Select **Spin**.
3. And touch the **Start/Pause** ▷||| button again.

Programme end

End lights up on the display panel and — and 🌀 displays are off.

If you have selected 🌀, the water is only drained after rinse process, no spin cycle.

Removing laundry/switching off the appliance

1. Set programme selector to **Off**.
2. Open the door and remove the laundry.
3. Turn off the water tap.
Note: Not required for Aqua-Stop models.

Notes

- Do not leave any items of laundry in the drum. They may shrink in the next wash or discolour another item.
- Remove any foreign objects from the drum and the rubber seal – risk of rusting.
- Wipe the rubber seal dry.

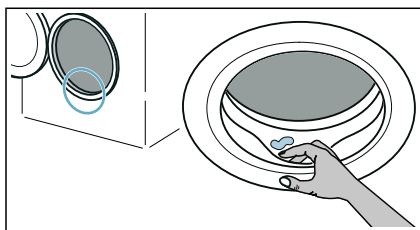

- Leave the door and detergent drawer open so that any residual water can evaporate.
- Always wait until the programme ends, as the appliance could still be locked. Then switch the appliance on and wait for it to unlock.

Appliance settings

You can change the following settings:

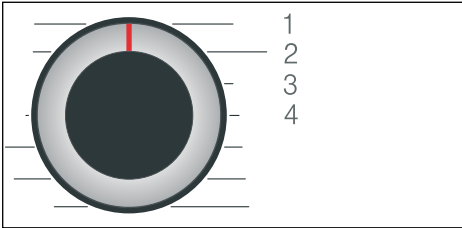

- The volume of the end signal.
- The volume of the button signal.
- Switching the drum care information signal on/off.

You will need to activate the setting mode in order to change these settings.



1/2/3/4... positions on the programme selector

Activate setting mode:

1. Set the programme selector to position 1. The appliance is switched on.
2. Touch and hold the  **Spin** button and, at the same time, turn the programme selector clockwise to position 2. Release the  **Spin** button.

The setting mode is activated and the preset setting appears in the display panel.

Changing the volume and drum care information



Use the  **Ready In** button to change the following settings at the corresponding programme selector positions:

- 2: The volume of the end signal.
- 3: The volume of the button signals.



0 = off, 1 = quiet,
2 = medium, 3 = loud,
4 = very loud

- 4: Switching the drum care information signal on/off.

 on
 off

Exiting setting mode

You can now end the process and set the programme selector to the **Off** position. The settings are saved.



Sensors

Unbalanced load detection system

The automatic unbalanced load detection system detects imbalances and ensures even distribution of the laundry by repeatedly starting and stopping drum spinning.

If the laundry is extremely unevenly distributed, the spin speed is reduced or the spin cycle is not performed for safety reasons.

Note: Place large and small items of laundry evenly in the drum.



Cleaning and maintenance



Warning **Risk of death!**

There is a risk of electric shock if touch live components.
Turn the programme selector to **Off**.
Pull out the mains plug.

Caution!

Fire and explosion hazard!

Toxic vapours can be produced by cleaning agents that contain solvents, e.g. cleaning solvent.
Do not use cleaning agents that contain solvents.

Caution!

The appliance may be damaged!

Cleaning agents that contain solvents, e.g. cleaning solvent, can damage surfaces and components in the appliance.
Do not use cleaning agents that contain solvents.

Appliance housing/control panel

- Remove the detergent residue immediately.
- Wipe the housing and the control panel with a soft, damp cloth.
- Do not use abrasive cloths, sponges or detergents (stainless steel cleaner).
- Do not clean the appliance with a water jet.

Drum

Use chlorine-free cleaning agents, do not use steel wool.

If there are odours in the appliance, or to clean the drum, run the **Drum Clean 90 °C** programme without laundry.

Descaling

Descaling should not be necessary if the detergent is measured out correctly. However, if it is required, follow the manufacturer's instructions for the descaling agent. Suitable descalers can be obtained via our website or from customer services.

Emptying the detergent draw, cleaning the detergent drawer and its housing

If the appliance contains detergent or fabric softener residues:

1. Pull out the detergent drawer. Press down the insert and fully remove the drawer.

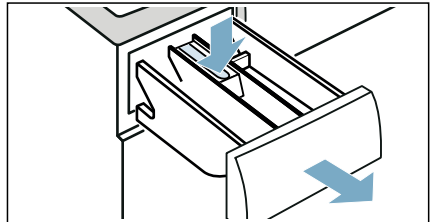

2. To remove the insert: Push the insert upwards from below with your finger.

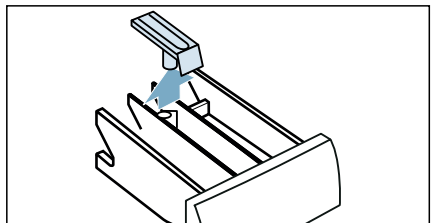

3. Clean the detergent dispenser tray and insert with water and a brush, and dry it. Clean the inside of the housing as well.

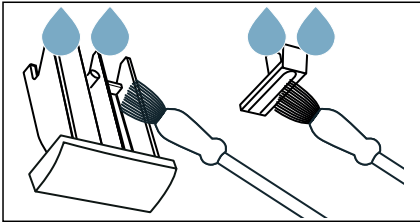

4. Fit the insert and lock it in place (push the cylinder onto the guide pin).

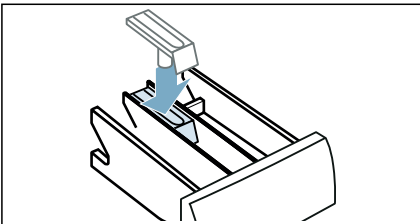

5. Push in the detergent drawer.

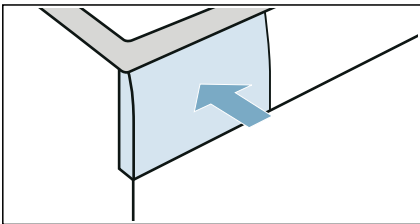

Note: Leave the detergent drawer open so that any residual water can evaporate.

Cleaning the measuring aid A* for liquid detergent

If it contains liquid detergent residue:

1. Hold the measuring aid, pull the cover upward and disconnect them.

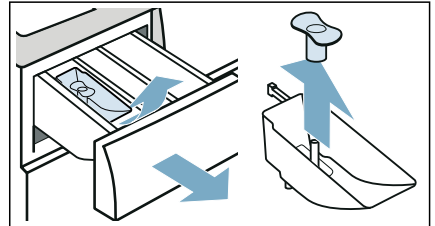

2. Clean the measuring aid and cover with water and brush.

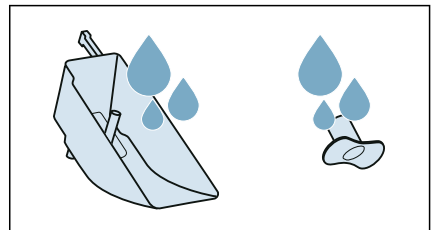

3. Install the cover back to the measuring aid. Pay attention to the assemble mark, and press the cover until click sounds.

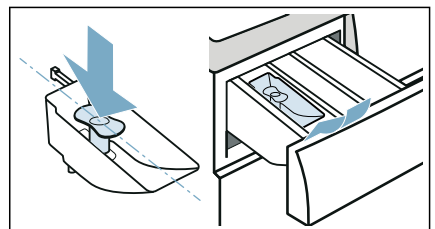

Note: Clean the measuring aid regularly to avoid residue and blockages.

* depending on the model

Drain pump is blocked

Note: Turn the water tap off to prevent more water from flowing in and to ensure that it is drained via the pump.

Warning

Risk of scalding!

When you wash at high temperatures, the water gets very hot. If you come into contact with the hot water, you may be scalded.

Allow the water to cool down first.

1. Turn the programme selector to **Off**. Pull out the mains plug.
2. Open the service flap.

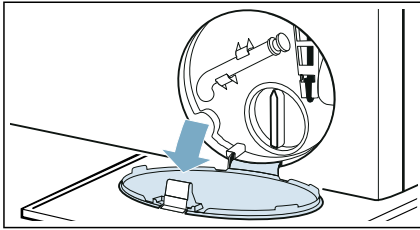

3. Take the drain hose out of the retainer. Remove the sealing cap and pour the water out into a suitable container. Replace the sealing cap and place the drain hose back in the retainer.

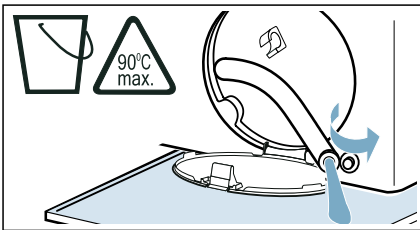

4. Carefully unscrew the pump cover; residual water may leak out. Clean the interior, pump cover thread and pump housing. The impeller in the drain pump must be able to rotate.

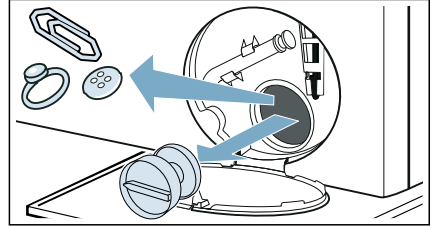

5. Refit and screw on the pump cover. The handle must be in a vertical position.

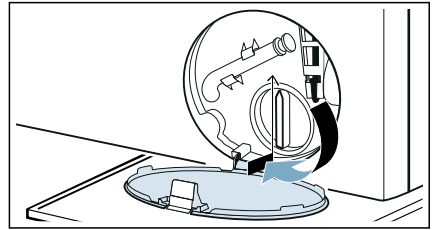

6. Close the service flap.

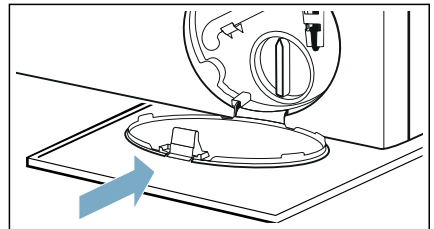

Note: To prevent unused detergent from flowing straight into the drain during the next wash: Pour 1 litre of water into dispenser II and start the **Spin** programme.

The drain hose at the siphon is blocked

1. Turn the programme selector to **Off**. Pull out the mains plug.
2. Loosen the hose clamp. Carefully remove the drain hose; residual water may leak out.
3. Clean the drain hose and siphon connecting piece.

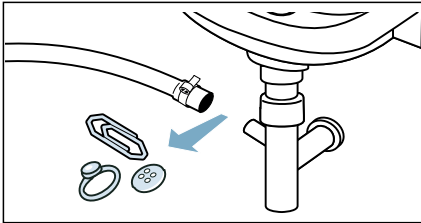

4. Re-attach the drain hose and secure the connection point using the hose clamp.

Filter in the water supply is blocked

Release water pressure in the supply hose:

1. Turn off the water tap.
2. Select the **Cottons** (activate $\equiv \text{C}$ **SpeedPerfect** setting) programme.
Note: If your appliance with intelligent dosing system*, you also need to deactivate the intelligent dosing system.
3. Select the **Start/Pause** $\triangleright \parallel$ button. Allow the programme to run for approx. 40 seconds.
4. Turn the programme selector to **Off**.
5. Pull out the mains plug.

Clean the filters:

1. Disconnect the hose from the rear of the appliance.

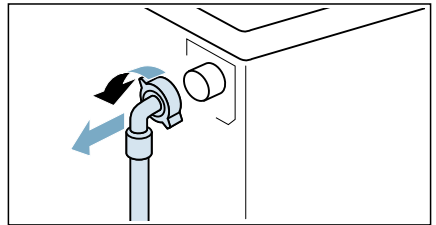

2. Use pliers to remove the filter.

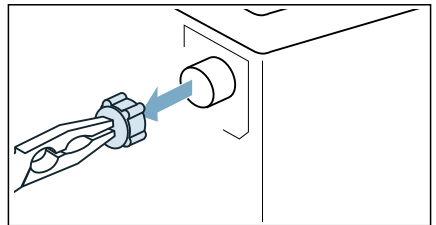

3. Clean the filter with a small brush.

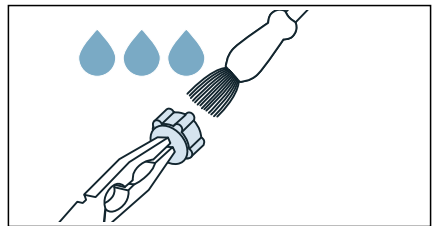

4. Connect the hose and check for leaks.

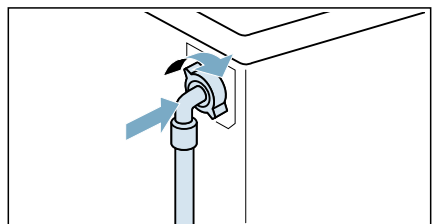

* Depending on the module

Faults and what to do about them

Emergency release

E.g. power outage or in the event of a loss of power

The programme continues when the power supply is restored.

However, if the laundry has to be removed, the appliance door can be opened as follows:

Warning **Risk of scalding!**

When you are washing at high temperatures, there is a risk of scalding if you come into contact with hot water and laundry.

If possible, leave it to cool down first.

Warning **Risk of injury!**

Reaching into the drum while it is still turning may cause hand injuries. Do not reach into the drum when it is turning.

Wait until the drum has stopped turning.

Caution! **Water damage!**

Any escaping water may cause water damage.

Do not open the door if water can be seen through the glass.



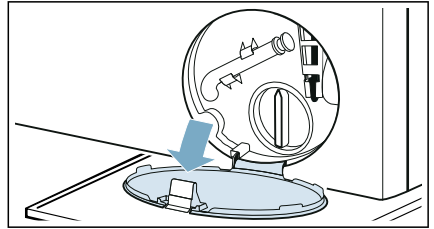

1. Turn the programme selector to **Off**. Pull out the mains plug.
2. Open the service flap.

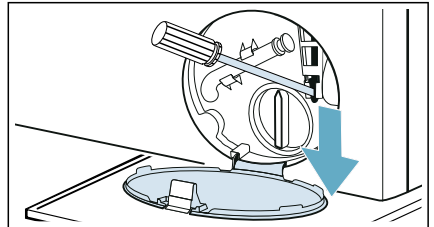



3. Drain the water. → *Page 40*
4. Pull the emergency release downwards with a tool and release. The door can then be opened.



Information on the display panel

Display	Cause/Remedy
	<ul style="list-style-type: none"> ■ Flashes fast + signal: The door was opened and the water level is too high. Close the door, continue the programme with Start/Pause  button or select Spin. ■ Flashes slowly: The door lock temperature is too high to open the door. Wait approx. 30 seconds until the door lock temperature cools down.
	<ul style="list-style-type: none"> ■ Flashes (no water supply): Water tap turned on? Filter in the water supply is blocked? → <i>"Filter in the water supply is blocked" on page 41</i> If an additional water filter has been installed (depending on the model), check for contaminants and clean if required → separate installation and cleaning instruction for water filter. Is the supply hose kinked or trapped? ■ Lights up (low water pressure): For information only. This will not affect the programme progress. The programme duration is extended.
 lights up	The childproof lock is activated – deactivate it.
The symbol  flashes	<p>Run the Drum Clean programme to clean and care for the drum and the outer tub.</p> <p>Notes</p> <ul style="list-style-type: none"> ■ Run the programme without laundry. ■ Use washing powder or a detergent containing bleach. To prevent foaming, only use half the amount of detergent recommended by the detergent manufacturer. Do not use detergent designed for woollens or delicates. ■ Switching the drum care information signal on/off. → <i>Page 37</i>
E:36 alternating with -10 and End when programme is finished	<ul style="list-style-type: none"> ■ The drain pump is blocked. → <i>"Drain pump is blocked" on page 40</i> ■ The drain hose at the siphon is blocked. → <i>"The drain hose at the siphon is blocked" on page 41</i>
E:35 alternating with -10 and End when programme is finished (Suitable for special models)	There is water in the base trough, the appliance is leaking. Turn off the tap. Call customer services.
Other displays	Turn the programme selector to Off , wait for five seconds and then switch it on again. If the display appears again, call customer services.

Faults and what to do about them

Faults	Cause/Remedy
Water is leaking from the appliance.	<ul style="list-style-type: none"> ■ Attach the drain hose correctly or replace it. ■ Tighten the screw fitting on the supply hose.
The door cannot be opened.	<ul style="list-style-type: none"> ■ The temperature in drum is too high to open the door. ■ The safety function is activated. Stop the programme? ■ The water level in drum is too high. ■ Can the door only be opened by the emergency release? → "Emergency release" on page 42
The appliance is not filling with water. Detergent is not being dispensed.	<ul style="list-style-type: none"> ■ Programme does not start? ■ Is the tap turned on? ■ Could the filter in the water supply be blocked? → "Filter in the water supply is blocked" on page 41 Note: If an additional water filter has been installed (depending on the model), check for contaminants and clean if required → separate installation and cleaning instruction for water filter. ■ Is the supply hose kinked or trapped?
The programme will not start.	<ul style="list-style-type: none"> ■ Have you touched the Start/Pause  button or selected  Ready In? ■ Is the door closed? ■ Childproof lock activated? Deactivate childproof lock. ■ Shop mode activated? If the display shows SHO for 5 s after you have switched on the appliance, the appliance is in shop mode. Wait for the display message SHO to disappear. Touch and hold Start/Pause  for at least 5 s. OFF will appear in the display panel. Turn the programme selector to Off. Now you already turned off the shop mode. You can use the appliance now as usual.
The programme has started and the drum is rotating, but the drum is not filling with water.	Not a fault – Some programme specifically detect and weigh the load after the program has started in order to calculate the optimum amount of water for washing. The drum will then start filling with water.
The water is not draining.	<ul style="list-style-type: none"> ■ Could the drain pump be blocked? → "Drain pump is blocked" on page 40 ■ Could the drain hose at the siphon be blocked? → "The drain hose at the siphon is blocked" on page 41
Water is not visible in the drum.	Not a fault – the water is below the visible area.
The wrong detergent/fabric softener has been poured into the dispenser(s).	Empty the dispenser(s), clean it/them and pour in the correct product. → "Emptying the detergent draw, cleaning the detergent drawer and its housing" on page 38 → "Measure and add detergent and care products" on page 34
Detergent/fabric softener has congealed in the dispensers.	Empty the dispenser(s), clean it/them and pour in the correct product.

Faults	Cause/Remedy
Foam is leaking from the detergent drawer.	<p>Too much detergent used?</p> <p>Mix 1 tablespoon of fabric softener with ½ litre of water and pour into dispenser II. (Not for outdoor, sports and down-filled textiles!)</p> <p>Reduce detergent dosage for the next wash cycle.</p> <p>Use commercially available low foam detergent and care product which are suitable for machine.</p>
Repeated, intensive foaming.	<p>Have you used too much detergent? Add less detergent in the next time you run a wash cycle with the same load.</p>
Detergent/fabric softener drips off the seal and collects on the door or in the seal fold.	<p>There is too much detergent/fabric softener in the dispensers. Do not fill the dispensers above the max. mark.</p>
<p>The spin result is not satisfactory.</p> <p>Laundry wet/too damp.</p>	<ul style="list-style-type: none"> ■ Not a fault – the unbalanced load detection system has interrupted the spin cycle because the laundry is unevenly distributed. Distribute small and large items of laundry evenly in the drum. ■ Is Easy iron additional programme setting selected (depending on the model)? ■ Is  Silent Wash additional programme setting or Silent wash programme selected (depending on the model)? ■ Is the selected speed too low?
The spin cycle runs several times.	<p>Not a fault – the unbalanced load detection system is adjusting an imbalance.</p>
The programme is taking longer than usual.	<ul style="list-style-type: none"> ■ Not a fault – the unbalanced load detection system is adjusting an imbalance by repeatedly distributing the laundry. ■ Not a fault – the foam detection system is activated – a rinse cycle has been switched on.
The length of the programme changes during the wash cycle.	<p>Not a fault – the programme sequence is optimised for the specific washing process. This may change the length of the programme shown on the display panel.</p>
Odours, stain formation in the appliance.	<p>Run the Drum Clean 90°C programme without laundry.</p> <p>Add washing powder or a detergent containing bleach.</p> <p>Note: To prevent foaming, only use half the amount of detergent recommended by the detergent manufacturer. Do not use detergents designed for woollens or delicates.</p>
Loud noises, vibrations and appliance "movement" during the spin cycle.	<ul style="list-style-type: none"> ■ Is the appliance aligned? → <i>"Alignment" on page 18</i> ■ Are the appliance's feet fixed? Secure the appliance's feet. ■ Have the transport locks been removed? → <i>"Removing the transport locks" on page 14</i>
The display panel indicator lights do not work while the appliance is running.	<ul style="list-style-type: none"> ■ Has there been a power failure? ■ Have the fuses blown? Reset/replace the fuses. ■ If the fault occurs repeatedly, call customer services.

Faults	Cause/Remedy
There is detergent residue on the laundry.	<ul style="list-style-type: none">■ Some phosphate-free detergents contain water-insoluble residue.■ Select Rinse or brush the laundry after washing.
If you cannot rectify a fault yourself (after turning the programme selector to Off and switch on again) or a repair is required:	
<ul style="list-style-type: none">■ Turn the programme selector to Off. Pull out the mains plug.■ Turn off the tap and call customer services.	

After-sales service

If you cannot rectify a fault yourself, (→ *"Faults and what to do about them"* on page 42), please contact our after-sales service.

We will always find an appropriate solution to avoid unnecessary visits by engineers.

Please provide the after-sales service with the product number (E-Nr.) and the production number (FD) of the appliance.

E-Nr. _____ FD _____

E-Nr. Product number
FD Production number

You can find this information (depending on the model):

- On the inside of the loading door
- On the back of the appliance

Trust the expertise of the manufacturer. Contact us. By doing so, you can be sure that the repairs are carried out by trained service personnel using genuine spare parts.



Consumption values

Energy and water consumption, programme duration and residual moisture for the main washing programmes

(approximate values)

Programme	Load	Energy consumption*	Water consumption*	Programme duration*
Cottons 20 °C	9 kg	0.32 kWh	60 l	2 h
Cottons 40 °C	9 kg	0.48 kWh	56 l	2½ h
Cottons 60 °C	9 kg	0.89 kWh	57 l	3¾ h
Cottons 90 °C	9 kg	2.13 kWh	72 l	2¾ h
Synthetics 40 °C	4 kg	0.76 kWh	61 l	2½ h
Mix Load 40 °C	4 kg	0.50 kWh	44 l	1¼ h
Delicates/Silk 30 °C	2 kg	0.15 kWh	34 l	¾ h
 Wool 30 °C	2 kg	0.29 kWh	35 l	¾ h

Values determined according to the valid version of IEC60456.

* Observed values may deviate from the indicated values due to influence of water pressure, hardness and inlet temperature, ambient temperature, type, amount and soiling of laundry, detergent used, fluctuations in power supply and selected additional functions.



Technical data

Dimensions:

848 mm x 598 mm x 590 mm
(height x width x depth)

Weight:

72 kg

Mains connection:

Nominal voltage 220-240V, 50Hz

Minimum installation protection
(\Rightarrow)10A

Nominal power 1900-2300 W

Water pressure:

100–1000 kPa (1–10 bar)



Aqua-Stop warranty

Only for appliances with Aqua-Stop

In addition to warranty claims against the vendor based on the purchase agreement and to our appliance warranty, we will provide compensation under the following conditions:

1. If water damage is caused due to a fault in our Aqua-Stop system, we will compensate domestic customers for the damage caused.
2. The liability guarantee is valid for the service life of the appliance.
3. It is a prerequisite of all warranty claims that the appliance with Aqua-Stop must have been installed and connected correctly in accordance with our instructions; this also includes a correctly fitted Aqua-Stop extension (genuine accessories). Our warranty does not cover defective feed lines or fittings leading to the Aqua-Stop connection at the tap.
4. Appliances with Aqua-Stop do not need to be supervised during operation, nor secured afterwards by turning off the tap.
The tap only needs to be turned off if you are away from home for a long period, e.g. for several weeks' holiday.



Thank you for buying a Bosch Home Appliance!

Register your new device on MyBosch now and profit directly from:

- **Expert tips & tricks for your appliance**
- **Warranty extension options**
- **Discounts for accessories & spare-parts**
- **Digital manual and all appliance data at hand**
- **Easy access to Bosch Home Appliances Service**

Free and easy registration – also on mobile phones:

www.bosch-home.com/welcome



Looking for help? You'll find it here.

Expert advice for your Bosch home appliances, need help with problems or a repair from Bosch experts.

Find out everything about the many ways Bosch can support you:

www.bosch-home.com/service

Contact data of all countries are listed in the attached service directory.

Robert Bosch Hausgeräte GmbH

Carl-Wery-Straße 34

81739 München, GERMANY

www.bosch-home.com



9001444850 (9908)

en