

INDUCTION COOKTOP

Use & Care Guide

CUBIERTA DE INDUCCIÓN

Manual del Usuario

Models, Modelos 790.4283*, 790.4292*

* = Color number, número de color



ENGLISH

ESPAÑOL

Table of Contents

Cooktop Warranty	2	Before Using the Cooktop	7 - 9
Product Record	2	Setting Cooktop Controls	9 -12
Serial Plate Location	2	General Care & Cleaning	12-14
IMPORTANT SAFETY INSTRUCTIONS	3 - 4	Before You Call	15-16
Induction Cooktop Features	4 - 5	Protection Agreements	17
Induction Cooktop Display Messages	6	Sears Service	18

Kenmore Elite Warranty

When installed, operated and maintained according to all instructions supplied with the product, if this appliance fails due to a defect in material and workmanship within one year from the date of purchase, call 1-800-4-MY-HOME® to arrange for free repair.

For five years from the date of purchase, if the cooktop glass fails due to thermal shock or the cooktop elements are defective, call 1-800-4-MY-HOME® to arrange for free part replacement. After the first year from purchase date, you must pay the labor cost of part installation.

This warranty applies for only 90 days from the date of purchase if this appliance is ever used for other than private family purposes.

This warranty covers only defects in material and workmanship. Sears will NOT pay for:

1. Cracks in a ceramic glass cooktop that are not a result of thermal shock.
2. Stains and scratches on a ceramic glass cooktop resulting from accident or improper operation or maintenance.
3. Expendable items that can wear out from normal use, including but not limited to filters, belts, light bulbs, and bags.
4. A service technician to instruct the user in correct product installation, operation or maintenance.
5. A service technician to clean or maintain this product.
6. Damage to or failure of this product if it is not installed, operated or maintained according to the all instructions supplied with the product.
7. Damage to or failure of this product resulting from accident, abuse, misuse or use for other than its intended purpose.
8. Damage to or failure of this product caused by the use of detergents, cleaners, chemicals or utensils other than those recommended in all instructions supplied with the product.
9. Damage to or failure of parts or systems resulting from unauthorized modifications made to this product.

Disclaimer of implied warranties; limitation of remedies

Customer's sole and exclusive remedy under this limited warranty shall be product repair as provided herein. Implied warranties, including warranties of merchantability or fitness for a particular purpose, are limited to one year or the shortest period allowed by law. Sears shall not be liable for incidental or consequential damages. Some states and provinces do not allow the exclusion or limitation of incidental or consequential damages, or limitation on the duration of implied warranties of merchantability or fitness, so these exclusions or limitations may not apply to you.

This warranty applies only while this appliance is used in the United States or Canada.

This warranty gives you specific legal rights, and you may also have other rights which vary from state to state.

Sears, Roebuck and Co., Hoffman Estates, IL 60179
Sears Canada Inc., Toronto, Ontario, Canada M5B 2B8

Product Record

(See serial plate location illustration below)

Model No. **790.** _____

Serial No. _____

Date of Purchase: _____

READ AND SAVE THESE INSTRUCTIONS.
Save your sales receipt for future reference.

Serial Plate Location

You will find the model and serial number printed on the serial plate. The serial plate is located under the cooktop.

Please see the illustration for exact location. Remember to record the serial number **BEFORE INSTALLATION** of the cooktop (See Product Record above).

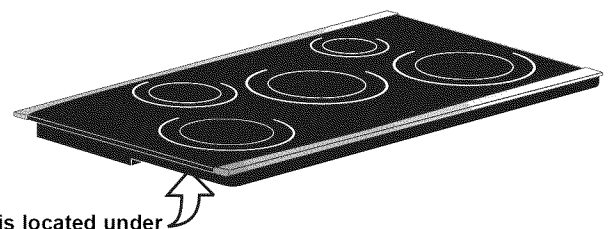

Serial plate is located under the burner box of cooktop.

Important Safety Instructions

Read all instructions before using this appliance. Save these instructions for future reference.

This manual contains important safety symbols & instructions. Please pay attention to these symbols & follow all instructions given.

⚠ WARNING This symbol will help alert you to situations that may cause serious bodily harm, death or property damage.

⚠ CAUTION This symbol will help alert you to situations that may cause bodily injury or property damage.

This unit has been tested and found to comply with the limits for a class B digital device, pursuant to Part 18 of the FCC rules. These limits are designed to provide reasonable protection against harmful interference in a residential installation. This unit generates, uses and can radiate radio frequency energy and, if not installed and used in accordance with the instructions, may cause harmful interference to radio communications. However there is no guarantee that interference will not occur in a particular installation. If this unit does cause harmful interference to radio or television reception, which can be determined by turning the unit off and on, the user is encouraged to try to correct the interference by one or more of the following measures:

- Reorient or relocate the receiving antennae.
- Increase the distance between the unit and receiver.
- Connect the unit into an outlet or a circuit different from that to which the receiver is connected.

⚠ CAUTION Persons with a pacemaker or similar medical device should exercise caution using or standing near an induction unit while it is in operation, as the electromagnetic field may affect the working of the pacemaker or similar medical device. It would be advisable to consult your Doctor or the pacemaker or similar medical device manufacturer about your particular situation.

- **Remove all tape and packaging wrap before using the appliance. Destroy the carton and plastic bags after unpacking the appliance.** Never allow children to play with packaging material.
- **Proper Installation. Be sure your appliance is properly installed and grounded by a qualified technician in accordance with National Electrical Code ANSI/NFPA No.70-latest edition and local code requirements.** Install only per installation instructions provided in the literature package for this appliance.
- **In case of an emergency, know how to disconnect the electrical power to the appliance at the circuit breaker or fuse box.**
- **User Servicing—Do not repair or replace any part of the appliance unless specifically recommended in the manuals.** All other servicing should be done only by a qualified technician to reduce the risk of personal injury and damage to the cooktop. Sears Parts & Repair is the recommended repair service for this appliance.
- **Never modify or alter the construction of an appliance by removing panels, wire covers or any other part of the product.**
- **Storage on Appliance. Flammable materials should not be stored near or on the cooking surface.** This includes paper, plastic and cloth items, such as cookbooks, plasticware and towels, as well as

flammable liquids. Do not store explosives, such as aerosol cans, on or near the appliance. Flammable materials may explode and result in fire or property damage.

⚠ CAUTION Do not store items of interest to children in the cabinets above the appliance.

- **Do not leave children alone. Children should not be left alone or unattended in the area where an appliance is in use.** They should never be allowed to sit or stand on any part of the appliance.

⚠ CAUTION DO NOT TOUCH COOKING ZONES OR AREAS NEAR THESE SURFACES. Cooking Zones may be hot from residual heat even though they are dark in color. Areas near the Cooking Zones may become hot enough to cause burns. During and after use, do not touch, or let clothing or other flammable materials touch these areas until they have had sufficient time to cool.

⚠ WARNING Never use your appliance for warming or heating a room.

- **Wear Proper Apparel—Loose-fitting or hanging garments should never be worn while using the appliance.** Do not let clothing or other flammable materials contact hot surfaces.
- **Do Not Use Water or Flour on Grease Fires. Smother the fire with a pan lid, or use baking soda, a dry chemical or foam-type extinguisher.**
- **When heating fat or grease, watch it closely.** Fat or grease may catch fire if allowed to become too hot.
- **Use Only Dry Potholders. Moist or damp potholders on hot surfaces may result in burns from steam.** Do not let the potholders touch hot heating surface units. Do not use a towel or other bulky cloth instead of a potholder.
- **Do Not Heat Unopened Food Containers. Buildup of pressure may cause the container to burst and result in injury.**

IMPORTANT INSTRUCTIONS FOR USING YOUR INDUCTION COOKTOP

- **Know which touch key pads controls each surface of the Cooking Zones.**
- **Clean the appliance regularly to keep all parts free of grease that could catch fire.** Exhaust fan ventilation hoods and grease filters should be kept clean. Do not allow grease to accumulate on hood or filter. Greasy deposits in the fan could catch fire. When flaming food under the hood, turn fan on. Refer to hood manufacturer's instructions for cleaning.

Important Safety Instructions

- **Use Proper Pan Size.** This appliance is equipped with one or more COOKING ZONES of different sizes. Select utensils having flat bottoms large enough to cover the minimum Cooking Zones. The pan detection sensors will not allow the affected Cooking Zone to operate without a pan of sufficient size present.
- **Utensil Handles Should Be Turned Inward and Should Not Extend Over Adjacent Cooking Zones.** To reduce the risk of burns, ignition of flammable materials, and spillage due to unintentional contact with the utensil.
- **Never Leave Prepared Food on the Cooking Zones Unattended.** Boilovers cause smoking and greasy spillovers that may ignite, or a pan that has boiled dry may melt or become damaged.
- **Protective Liners.** Do not use aluminum foil to line any part of the cooktop. Only use aluminum foil as recommended after the cooking process, if used as a cover to be placed over the food. Any other use of aluminum foil may result in the risk of electric shock, fire or short circuit.
- **Glazed Cooking Utensils.** Only certain types of glass, glass/ceramic, ceramic, earthenware, or other glazed utensils are suitable for range top service without breaking due to the sudden change in temperature. Check the manufacturer's recommendations for cooktop use.
- **Ventilating hood.** The ventilating hood above your cooking surface should be cleaned frequently, so the grease from cooking vapors does not accumulate on the hood or filter.

FOR CERAMIC COOKTOP ONLY

- **Do Not Clean or Operate a Broken Cooktop.** If cooktop should break, cleaning solutions and spillovers may penetrate the broken cooktop and create a risk of electric shock. Contact a qualified technician immediately.
- **Clean Cooktop with Caution.** If a wet sponge or cloth is used to wipe spills on a hot cooking area, be careful to avoid a steam burn. Some cleaners can produce harmful fumes if applied to a hot surface.
- **Do Not Place Hot Cookware on Cold Cooktop Glass.** This could cause glass to break.
- **Do not slide pans across the cooktop surface.** They may scratch the cooktop surface.
- **Do not let pans boil dry.** This may cause permanent damage in the form of breakage, fusion, or marring that can affect the ceramic-glass cooktop. (This type of damage is not covered by your warranty).

IMPORTANT SAFETY NOTICE

The California Safe Drinking Water and Toxic Enforcement Act requires the Governor of California to publish a list of substances known to the state to cause cancer, birth defects or other productive harm, and requires businesses to warn customers of potential exposure to such substances.

Induction Cooktop Features

A COOLER COOKTOP - A unique feature of the Induction Cooktop is whether turned ON or OFF, the cooktop surface remains cooler than standard ceramic cooktops.

CAUTION The Cooking Zones may appear to be cool while turned ON and after they have been turned OFF. But the glass surface may be HOT from residual heat transferred from the cookware and burns may occur.

MAGNETIC DETECTOR - The coil sensor automatically detects if a pan is magnetic; if it is not, the Cooking Zone will not activate.

PAN SIZE DETECTION - The pan detection sensor automatically adapts the size of Cooking Zones to the pan sizes in use.

EFFICIENT - Induction cooking heats faster while using less energy. Induction power boils more quickly and simmers more evenly.

Induction Cooktop Features

READ THESE INSTRUCTIONS CAREFULLY BEFORE USING THE INDUCTION COOKTOP

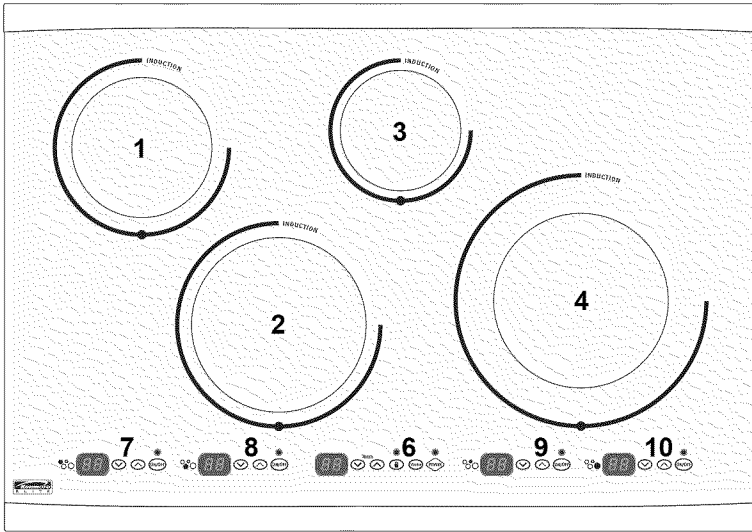

Fig. 1 - 30" Model

1. Left Rear Cooking Zone (Fig. 1 & 2)
2. Left Front Cooking Zone (Fig. 1 & 2)
3. Right Rear Cooking Zone (Fig. 1 & 2)
4. Right Front Cooking Zone (Fig. 1 & 2)
5. Center Cooking Zone (Fig. 2 only)
6. Main Cooktop Controls (Fig. 1, 2 & 3)
7. Left Rear Cooking Zone Control Pads (Fig. 1 & 2)
8. Left Front Cooking Zone Control Pads (Fig. 1 & 2)
9. Right Rear Cooking Zone Control Pads (Fig. 1 & 2)
10. Right Front Cooking Zone Control Pads (Fig. 1 & 2)
11. Center Cooking Zone Control Pads (Fig. 2 only)
12. Cooktop Power Key Pad
13. Cooktop Power LED
14. Keep Warm Setting Key Pad
15. Controls Lock Key Pad
16. Controls Lock LED
17. Minute Timer Setting Up/Down Arrow Key Pads

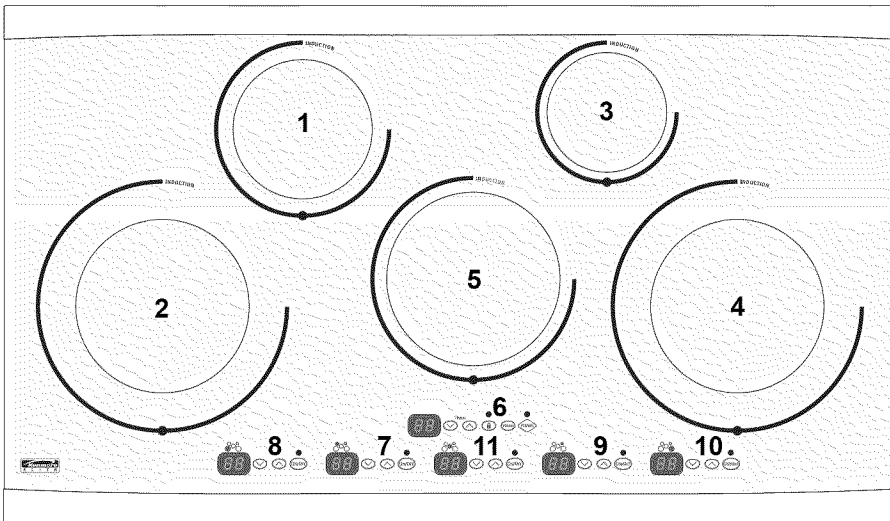

Fig. 2 - 36" Model

18. Minute Timer Alpha-Numeric (A-N) Display (displays up to 99 minutes)
19. Cooking Zone ON/OFF Key Pad (for each Cooking Zone)
20. Cooking Zone ON/OFF LED (for each Cooking Zone).
21. Cooking Zone Up Arrow Power Key Pad (for each Cooking Zone).
22. Cooking Zone Down Arrow Power Key Pad (for each Cooking Zone).
23. Cooking Zone Power Level Alpha-numeric display (for each Cooking Zone).

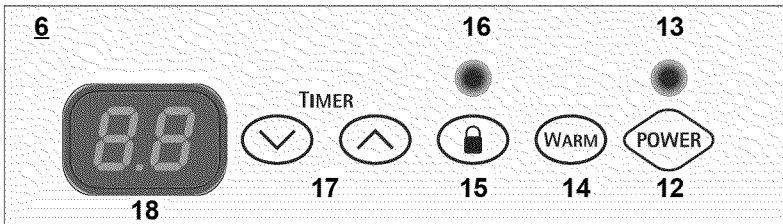

Fig. 3 - Main Cooktop Controls

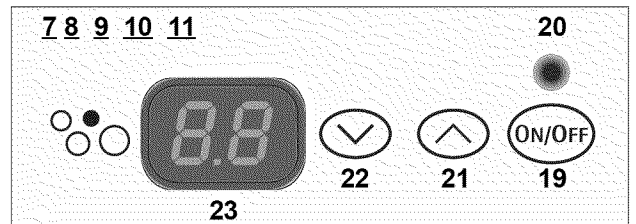

Fig. 4 - Cooking Zone Controls (at 4 or 5 locations)

ENGLISH

Induction Cooktop Display Messages

LED Messages or Light Indicators Displayed by Main Control

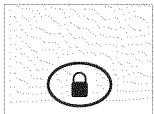

Fig. 1

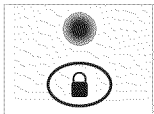

Fig. 2

CONTROLS LOCK - This feature allows the cooktop to be locked only when the cooktop is switched to OFF. Touch and hold the LOCK key pad for 5 seconds. A beep will sound and the Lock LED will glow (Fig. 2). Once locked, no other displays will glow and no Cooking Zones will activate. To turn the Controls Lock OFF, touch and hold the LOCK key pad for 5 seconds. A beep will sound, the Lock LED will turn OFF (Fig. 1) and the cooktop may be used normally.

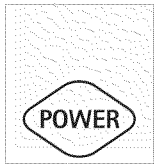

Fig. 3

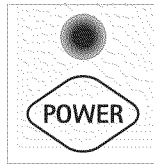

Fig. 4

COOKTOP POWER - The Cooktop POWER key pad activates the entire Cooktop. To power the cooktop, touch and hold the POWER key pad for 2 seconds. A beep will sound and the Power LED will glow (See Fig. 4). The cooktop will be in a ready mode for 10 seconds. If no other key pads are touched the Cooktop Main POWER will turn OFF automatically. To turn the Main Power OFF touch and hold the Main POWER key pad for 1 second. A beep will sound and the Power LED will turn OFF (See Fig. 3).



Fig. 5



Fig. 6

Error Codes Alpha-Numeric Display E0XX - The control displays **E** in Cooking Zone Alpha-Numeric display (Fig. 5) and digits in Main Control LED (Fig. 6) together showing an error code. For service call **1-800-4-MY-HOME®** (See back cover of this manual).

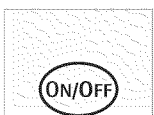

Fig. 7

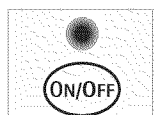

Fig. 8

Alpha-Numeric Messages or LED Displayed by Cooking Zone Controls

COOKING ZONE ON/OFF PAD - Each of the Cooking Zones have separate ON/OFF key pads. Once the Main Power key pad has been touched to activate the cooktop, touch the corresponding Cooking Zone ON/OFF key pad once to activate the Cooking Zone needed. "- -" will appear in the Alpha-Numeric display. If the corresponding UP/DOWN Arrow key pad is not touched within 10 seconds, the request to turn the Cooking Zone ON will cancel and the Cooktop will go back to ready mode. To set a Cooking Zone power level touch the corresponding Cooking Zone UP or DOWN Arrow key pad once. The Cooking Zone ON/OFF LED will glow (Fig. 8). To turn OFF a Cooking Zone, touch the Cooking Zone ON/OFF key pad once. The Cooking Zone LED will turn OFF (Fig. 7).



Fig. 9



Fig. 10

POWER LEVEL SETTINGS - The Cooking Zones have separate Power Level Alpha-Numeric displays. Once active, the Cooking Zones will provide 22 Power Levels to choose from. These include **L0** (Fig. 11), **2, 3, 4, 5, 6, 7, 8, 9**; as well as precise **.2** increment Cooking Zone Power Levels between **L0** and **3** (Fig. 9); and half-increment power levels between **3** and **7** (Fig. 12). The highest setting **P** or "Power Boost" provides 125% power for 10 minutes (See Fig. 10). Each key pad touch (or just holding down the Power Level key pad) will scroll through all the available power levels for any Cooking Zone quickly.

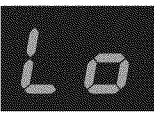

Fig. 11



Fig. 12



Fig. 13

RESIDUAL HEAT - Once any Cooking Zone has been used for cooking and turned OFF, and if the cooktop surface temperature on any of the Cooking Zones is still too HOT, **HE** (See Fig. 13) will appear in the Alpha-Numeric display for the affected Cooking Zone. The **HE** will continue to display if the temperature is still too HOT.

CAUTION The Cooking Zones may appear to be cool while turned ON and after they have been turned OFF. **But the glass surface may be HOT** from residual heat transferred from the cookware and burns may occur if surface is touched.



Fig. 14

KEEP WARM - Use the WARM key pad to activate the Warm setting for any of the Cooking Zones. The ON/OFF key pad for the desired Cooking Zone must be activated first, then touch the WARM key pad located in the Cooktop Main Control area once to set. **LH** (low heat) should appear in the corresponding Cooking Zone Alpha-Numeric display (See Fig. 14).

PAN DETECTION - All five Cooking Zones will provide a Pan Detection message. If a Cooking Zone is turned ON and no pan is detected, or the pan has been moved or is not centered correctly, or is not made of magnetic material, power level will flash in the affected Cooking Zone Alpha-Numeric display.

Before Using the Cooktop

USE THE CORRECT COOKWARE TYPE - The magnetic Cooking Zone sensors located below the cooktop surface require the use of cookware made with magnetic material in order to start the heating process on any of the Cooking Zones.

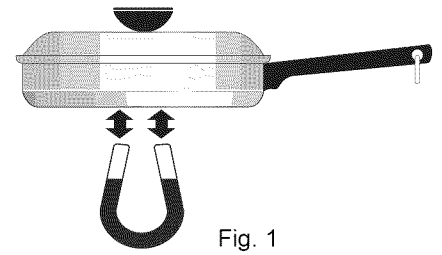

Fig. 1

When purchasing pans, look for cookware specifically identified by the manufacturer for use with Induction cooktops. If you are not sure, use a magnet to test whether the cookware type will work. If a magnet sticks to the bottom of the cookware, the material type is correct for Induction cooking (See Fig. 1).

It is recommended to always use heavier high quality stainless steel cookware on your Induction Cooktop surface. This will greatly reduce the possibility of developing scratches on the ceramic surface.

Even quality cookware can scratch the cooktop surface, especially if cookware is slid over the ceramic cooktop surface without being lifted up. Over time sliding **ANY** type of cookware over the ceramic cooktop will likely alter the overall appearance of the cooktop. Eventually the buildup of scratches will make cleaning the surface difficult and degrade the overall appearance of the cooktop.

Minimum Pan Size Requirements for each Cooking Zone

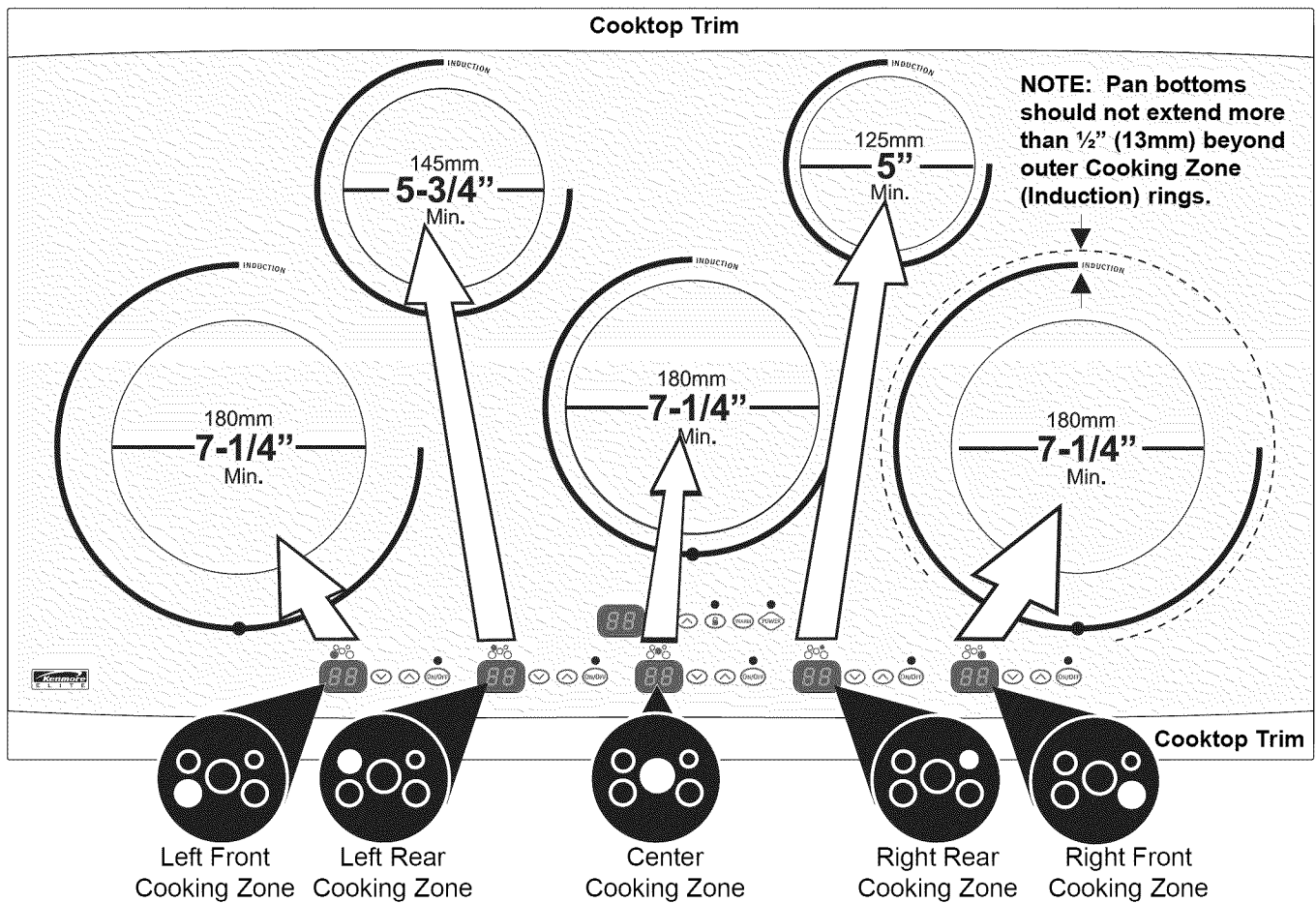

Fig. 2 - 36" model shown only

USE THE CORRECT SIZE COOKWARE - The Cooking Zones available on the Induction Cooktop require a **MINIMUM** pan size to be used at each location (Fig. 2). The inner ring of each Cooking Zone is your guide to the correct **MINIMUM** pan size. The pan bottom must **FULLY** cover the inner ring for proper cooking to occur.

The thicker outer ring at each Cooking Zone is helpful to determine the pan **MAXIMUM** size. After centering the cookware on the cooktop, make sure the cookware does not extend more than 1/2" beyond the thicker line on the Cooking Zone (See example in Fig. 2). The pan must make **FULL** contact on the glass surface without the bottom of the pan touching the metal cooktop trims (Shown in Fig. 2).

NOTE: If a pan made of the correct material is centered properly on any of the active Cooking Zones but is **TOO SMALL**, the affected Cooking Zone display will flash the power level and the pan will not heat.

ENGLISH



Before Using the Cooktop

Induction Cookware Recommendations

Use Quality Cookware in Good Condition

The cookware used with the Induction Cooktop should have flat bottoms that make good contact with the entire surface of the Cooking Zone. Check for flatness by rotating a ruler across the bottom of the cookware (See Fig. 1). Be sure to follow all the recommendations for using cookware as shown in Fig. 2.

Also remember to:

- Use cookware made with the correct material type for Induction Cooking (See page 7 Fig. 1).
- Use quality cookware with heavier bottoms for better heat distribution allowing for more even cooking results.
- The pan size should match the amount of food being prepared.
- **Do not let pans boil dry.** This may cause permanent damage in the form of breakage, fusion, or marring that can affect the ceramic cooktop. (This type of damage is not covered by your warranty).
- Do not use dirty pans with grease buildup. Always use pans that are easy to clean after cooking.

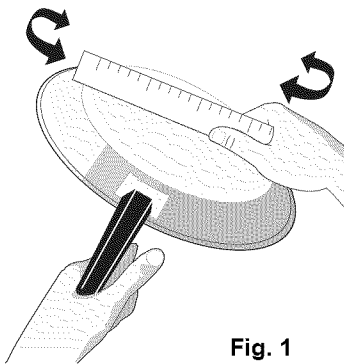

Fig. 1

CAUTION The Cooking Zones may appear to be cool while turned ON and after they have been turned OFF. **But the glass surface may be HOT** from residual heat transferred from the cookware and burns may occur.

CAUTION DO NOT TOUCH HOT COOKWARE or PANS directly with hands. Always use oven mitts or pot holders to protect hands from burns.

CAUTION DO NOT SLIDE Cookware across the cooktop surface. Doing so may permanently damage the appearance of the ceramic cooktop.

INCORRECT

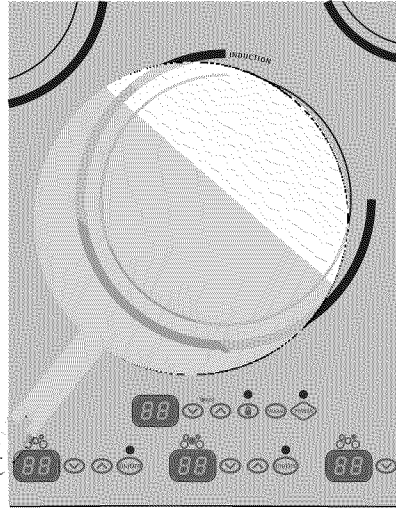

- Cookware not centered on Cooking Zone surface.

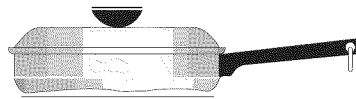

- Curved or warped pan bottoms or sides.

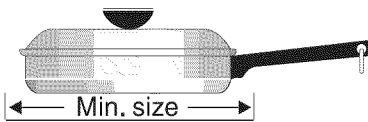

- Pan does not meet the minimum size required for the Cooking Zone used (See Fig. 19).

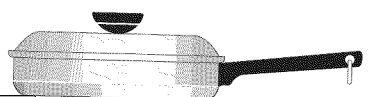

- Pan bottom rests on cooktop trim or does not rest completely on the cooktop surface.

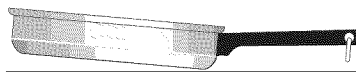

- Heavy handle tilts pan.

CORRECT

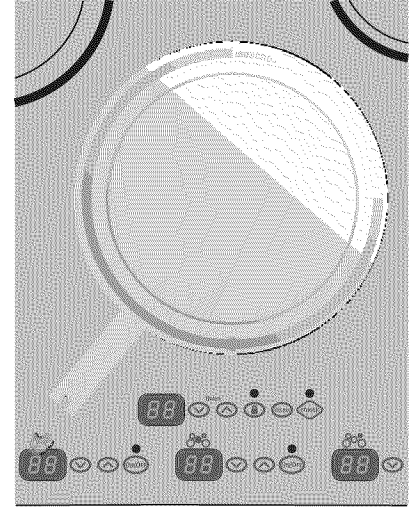

- Cookware centered correctly on Cooking Zone surface.

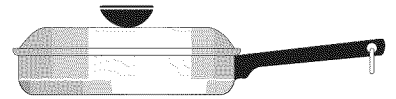

- Flat pan bottom & straight sides.

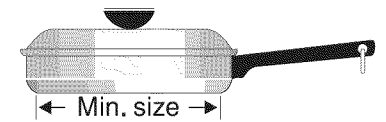

- Pan size meets or exceeds the recommended minimum size for the Cooking Zone (See Fig. 19).

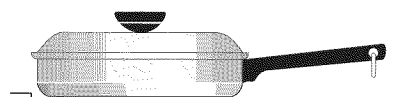

- Pan rests completely on the Cooktop surface.

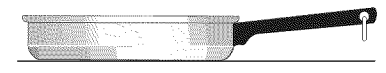

- Pan is properly balanced.

Fig. 2

PLEASE NOTE - ANY one of the incorrect conditions listed above in Fig. 2 may be detected by the sensors located below the ceramic cooktop surface. If the cookware does not meet any of these conditions, one or more of the Cooking Zones will not heat indicated by a flashing power level display. Correct the problems before attempting to reactivate the cooktop.

Before Using the Cooktop

Prior to using your cooktop for the first time, apply the recommended cooktop cleaning creme (on the web visit www.sears.com for replacement cleaner, item number 40079) to the ceramic surface. Buff with a non-abrasive cloth or no-scratch cleaning pad. This will make cleaning easier when soiled from cooking. The special cooktop cleaning creme leaves a protective finish on the glass to help prevent scratches and abrasions.

Setting Cooktop Controls

Using the Touch Control







Be sure that your finger is placed in the center of the touch pad. If the finger is not placed on the center of a pad, the cooktop may not respond to the selection made.





Lightly contact the pad with the flat part of your entire fingertip. Do not just use the narrow end of your fingertip.

Operating the Cooking Zones

The Induction cooktop has four or five Cooking Zones designed for cookware of various sizes. Be sure to place cookware that meets the minimum and maximum pan size requirements (see Fig. 2, page 7) for the Cooking Zone desired and is best for the amount of food being prepared. Place the cookware with the prepared food on the Cooking Zone **BEFORE** setting any of the Cooktop controls.

To Turn ON one or more of the Cooking Zones:

1. Place the prepared food using the correct type and size cookware on the desired Cooking Zone. Be sure to center the cookware on Cooking Zone completely covering the minimum ring marked on the Zone surface. PLEASE NOTE: If the cookware requirements for the Cooking Zone (See Fig. 2, page 8) are not met the sensors will detect a problem and the display will flash with the power level in the affected Cooking Zone Alpha-Numeric display. Any problems must be corrected before proceeding.
2. Touch and hold the  key pad for 2 seconds (or until a beep sounds). The Power LED located above the  key pad will turn ON. NOTE: If no other key pad is touched within 10 seconds the request to Power ON the cooktop will clear.
3. To start one or more of the five Cooking Zones lightly touch the  key pad for the Cooking Zones needed. A beep will sound and the chosen Cooking Zone power level Alpha-Numeric display will show “- -” indicating no power level for the Zone has been set yet. NOTE: If no other key pad is touched within 10 seconds the request to Power ON the Cooktop Zone will clear.
4. Set the desired power level for the Cooking Zone by touching either the  or  key pad. If the  key pad is touched the Cooking Zone will start at a “Power Boost” maximum power level (the Cooking Zone Alpha-Numeric display will indicate **Pb** and the control will beep once). If the  key pad is touched once the Cooking Zone will start at low (the Cooking Zone Alpha-Numeric display will show “Lo” and the control will beep once).

NOTE: Touch once, or repeatedly touch the  or  key pads to adjust or scroll through power levels at any time during the cooking process (To scroll through the power levels quickly touch and hold the  or  key pads until the power level desired is reached). Once the Cooking Zone power level has been set the food will begin to heat at that level until the power level is manually changed. For more information about the available Cooktop Zones power levels available see “Power Level Settings” section on page 6.



Setting Cooktop Controls

To Turn ON one or more of the Cooking Zones (cont'd)

IMPORTANT OPERATING NOTES:

- Fluids spilled or objects lying on the controls area of the cooktop may cause the cooktop to display an error code and turn OFF while cooking. Clean the spills or remove the objects from the cooktop.
- Be sure the cooktop vent holes are NOT blocked. If the vent holes are blocked the cooktop internal sensor may shut OFF the cooktop to avoid overheating the appliance.
- If the cookware or pan is moved from the center of any active Cooking Zone for any reason, a sensor will detect the situation and the cookware will no longer heat. The affected Cooking Zone Alpha-Numeric display will flash the power level set for the Cooking Zone. The Cooking Zone will remember the power level setting for up to 3 minutes before the Cooking Zone will automatically shut OFF.

To Turn OFF the Cooking Zones:

1. Once cooking is complete, touch the **ON/OFF** key pad to turn the Cooking Zone OFF.
2. The corresponding Cooking Zone ON/OFF LED located above the **ON/OFF** key pad will turn OFF. A beep will sound and the chosen Cooking Zone power level Alpha-Numeric display will turn off. If no other key pads are touched the Cooking Zone will shut OFF automatically in 10 seconds. If no other Cooking Zones are active and no other key pads are touched the entire cooktop will shut OFF automatically in 10 more seconds.
3. When any Cooking Zone is OFF, the corresponding Cooking Zone Alpha-Numeric display may show **HE** if the Cooking Zone temperature is HOT. The Alpha-Numeric display will continue to display **HE**, and even if the Cooktop is switched OFF the Alpha-Numeric display will continue to indicate **HE** as long as the cooking zone remains HOT.

⚠ CAUTION The Cooking Zones may appear to be cool while turned ON and after they have been turned OFF. **But the glass surface may be HOT** from residual heat transferred from the cookware and burns may occur.

Preheat Recommendations

When preheating a pan on the cooktop always watch carefully. Whenever using the cooktop, always pay attention to any items cooking and remain attentive until the cooking process is complete.

Keep in mind that induction may decrease the amount of time required to preheat a cooking utensil.

Keep Warm Feature

The Warm feature may be used with any of the Cooking Zones.

To Turn the Keep Warm Feature ON:



1. To select the Keep Warm feature for any Cooking Zone touch the **ON/OFF** key pad for the corresponding Cooking Zone.
2. Touch the **WARM** key pad located in the main control area. The Cooking Zone Alpha-Numeric display will show **LH** (Low heat) indicating that the Cooking Zone is properly set to Keep Warm.

Setting Cooktop Controls





Minute Timer

The Minute Timer feature may be useful in the kitchen if a recipe calls for keeping track of time. This feature will keep track of time from 1 to 99 minutes. The Alpha-Numeric display located to the left of the Timer UP/DOWN arrow key pads will begin to count down minutes once set.

To Set the Minute Timer:

1. Touch the  listed under the word "TIMER". Touching and releasing the  or the  key pads will increase or decrease the Minute Timer setting by 1 minute with each key press (up to **99** minutes).
2. Once the Timer Alpha-Numeric displays the desired amount of time, release the UP or DOWN Arrow key pads. The MinuteTimer will begin the countdown with remaining minutes. The timer will display seconds countdown for the last minute. Once the Minute Timer reaches **00** a long beep will sound each minute and the timer Alpha-Numeric display will flash "**00**" indicating that the time is up.





To Cancel the Minute Timer:

1. Touch the  and  key pads at the same time or touch and hold either the  or  key pad and scroll to **00**.
2. If cancelling the Minute Timer using the scrolling method, once the Main Control Alpha-Numeric display reaches **00**, release the Arrow key pad.
3. The set time will disappear from the LED indicating that the MinuteTimer is no longer active.





Locking the Controls

The Induction Cooktop may be locked in order to prevent the cooktop from accidentally being turned ON.

To Turn ON the Controls Lock Feature:

1. The Cooktop Lock will not activate until the cooktop is OFF. If the cooktop power is not OFF, touch and hold the  key pad until a beep sounds (about 1 second). The Power LED located above the  key pad will turn OFF.
2. Touch the  key pad until a beep sounds (about 5 seconds). The Lock LED above the  key pad will turn ON indicating the cooktop is locked. This will keep any Cooking Zone or Cooktop functions from being accidentally turned ON (See Fig. 2, page 6)

To Turn OFF the Controls Lock Feature:

1. Touch the  key pad until a beep sounds (about 5 seconds). The Lock LED above the  key pad will turn OFF indicating the cooktop is unlocked. The Cooking Zones or any of the other Cooktop functions may now be used (See Fig. 1, page 6).
2. If the cooktop is needed you must touch and hold the  key pad until a beep sounds (about 1 second). The Power LED located above the  key pad will turn ON. (See Fig. 4, page 6). You may now activate any of the Cooking Zones.

Setting Cooktop Controls

Power Sharing

The 36" cooktop is equipped with four cooking zones within two heating sections: right and left. Each section is powered by one induction inverter. The two cooking zones in the right and left section share the power of one inverter.

The 36" cooktop is equipped with five cooking zones within three heating sections: right, left and center. Each section is powered by one induction inverter. The two cooking zones in the right and left section share the power of one inverter. The center section has its own inverter.

If you are cooking in both zones of a heating section, the last zone that began to heat will cook at the power setting you selected. The other zone will experience a slight decrease from its power setting.

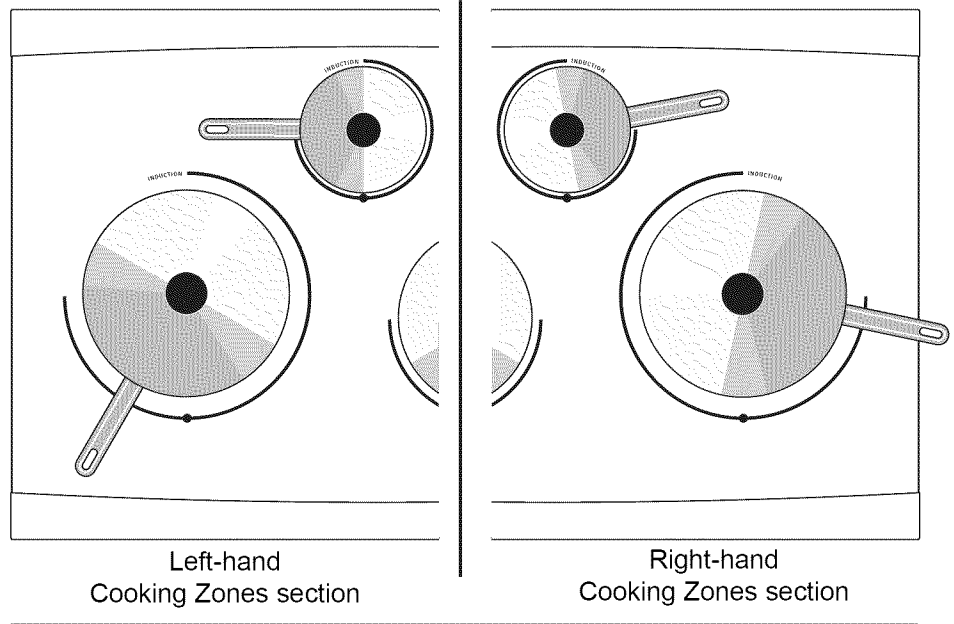

Fig. 1

Power Sharing Tips: Remember to select the power setting last for the cooking zone you want to maintain at full setting heat. To maintain full setting heat for two items, place one item on a zone in one section, and the other item on a zone in another section.

Operational Noises

The electronic processes involved with Induction Cooking create some unusual background noises. These noises are normal and part of the Induction Cooking process.

Please note that these noises are more noticeable while cooking at the Power BOOST level.

General Care & Cleaning

Cleaning Various Parts of Your Cooktop

Before cleaning any part of the cooktop, be sure all controls are turned OFF and the cooktop is COOL. REMOVE SPILLOVERS AND HEAVY SOILING AS SOON AS POSSIBLE. REGULAR CLEANINGS NOW WILL REDUCE THE DIFFICULTY AND EXTENT OF A MAJOR CLEANING LATER.

Surfaces	How to Clean
Stainless Steel , Chrome Decorative Trim	Clean with hot, soapy water and a dishcloth. Rinse with clean water and cloth. Do not use cleaners with high concentrations of chlorides or chlorines. Do not use harsh scrubbing cleaners. Only use kitchen cleaners that are especially made for cleaning stainless steel. Always be sure to rinse the cleaners off from the surface as bluish stains may occur during heating that cannot be removed.
Ceramic Glass Cooktop	See Ceramic Glass Cooktop Cleaning and Maintenance in this Use and Care Guide.
Plastic , Lenses of the Alpha-Numeric displays	Using a soft cloth, clean with mild dish detergent and water or a 50/50 solution of vinegar and water. Follow by rinsing the area with clean water; dry and polish with a soft cloth. Do not use liquid cleaners, abrasive cleaners, scouring pads, or some paper towels as they will damage the finish.

General Care & Cleaning

Ceramic Glass Cooktop Cleaning & Maintenance

Consistent and proper cleaning is essential to maintaining your Ceramic glass cooktop

Prior to using your cooktop for the first time, apply the recommended CookTop® Cleaning Creme to the ceramic surface (on the web visit www.sears.com for replacement cooktop cleaner, item number 40079). Buff with a **non-abrasive** cloth or **no-scratch** cleaning pad. This will make cleaning easier when soiled from cooking. The special cooktop cleaning cream leaves a protective finish on the glass to help prevent scratches and abrasions.

Sliding aluminum or copper clad bottom pans on the cooktop can cause metal markings on the cooktop surface. These marks should be removed **immediately** after the cooktop has cooled using the cooktop cleaning cream. Metal marks can become permanent if not removed prior to future use.

Cookware (cast iron, metal, ceramic or glass) with rough bottoms can mark or scratch the cooktop surface. **Do not slide anything metal or glass** across the cooktop. **Do not** use your cooktop as a cutting board or work surface in the kitchen. **Do not** cook foods directly on the cooktop surface without a pan. **Do not** drop heavy or hard objects on the glass cooktop, because they may cause it to crack.

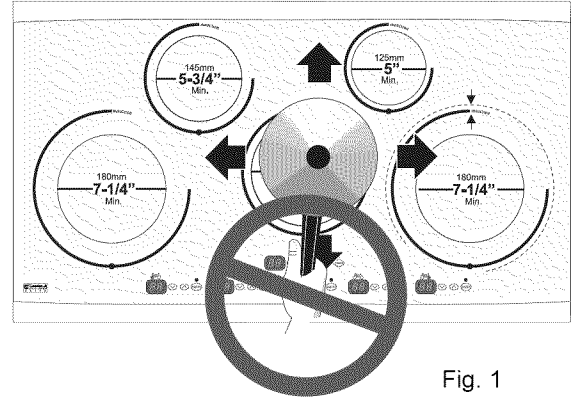

Fig. 1

Cleaning Recommendations for Ceramic Glass Cooktop

CAUTION Before cleaning the cooktop, be sure the controls are turned to **OFF** and the cooktop is **COOL**.

WARNING **DO NOT** use a cooktop cleaner on a hot cooktop. The fumes can be hazardous to your health, and can chemically damage the ceramic-glass surface.

For light to moderate soil:

Apply a few drops of CookTop® Cleaning Creme directly to the cooktop. Use a paper towel or use a **non-abrasive** plastic type **no-scratch** pad to clean the entire cooktop surface. Make sure the cooktop is cleaned thoroughly, leaving no residue.

For heavy, burned on soil:

Apply a few drops of CookTop® Cleaning Creme directly to the soiled area. Rub the soiled area using a **non-abrasive** plastic type **no-scratch** pad, applying pressure as needed. Do not use the pad you use to clean the cooktop for any other purpose.

If soils remain, carefully scrape soils with a metal razor blade scraper, holding scraper at a 30 degree angle to the surface. Remove loosened soils, then apply a few drops of cleaning cream and buff surface clean.

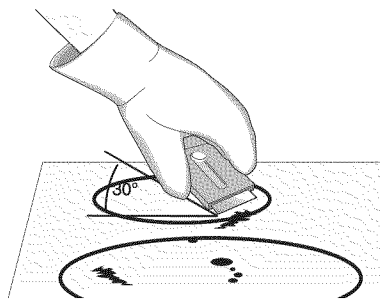

Fig. 2

IMPORTANT NOTE: Damage to the ceramic glass cooktop may occur if you use an abrasive type scratch pad. Only use cleaning products that have been specifically designed for ceramic glass cooktop.

Plastic or foods with a high sugar content:

These types of soils need to be removed immediately if spilled or melted onto the ceramic cooktop surface. Permanent damage (such as pitting of the cooktop surface) may occur if not removed **immediately**. After turning the surface elements **OFF**, wear a hand mitt and use a razor blade scraper or a metal spatula to scrape the soil from the hot surface (as illustrated). Avoid contact between the mitt and hot surface. Allow the cooktop to cool, and use the same method for heavy or burned on soils.

General Care & Cleaning

Do not use the following on the ceramic cooktop and display lenses (See Fig. 1):

- Do not use abrasive cleaners and scouring pads, such as metal and some nylon pads. They may scratch the cooktop, making it more difficult to clean.
- Do not use harsh cleaners, such as chlorine bleach, ammonia or oven cleaners, as they may etch or discolor the cooktop.
- Do not use dirty sponges, cloths or paper towels, as they can leave soil or lint on the cooktop which can burn and cause discoloration.

Special Caution for Aluminum Foil and Aluminum Cooking Utensils

1) Aluminum foil

Use of aluminum foil will damage the cooktop. Do not use under any circumstances.

2) Aluminum utensils

Since the melting point of aluminum is much lower than other metals, care must be taken when aluminum pots or pans are used. Pans that boil dry may permanently damage cooktop by breaking, fusing to, or marking it.

Care and Cleaning of Stainless Steel (Stainless Steel models only)

Some models are equipped with stainless steel exterior parts. Special care and cleaning are **required** for maintaining the appearance of stainless parts. Please refer to the table provided at the beginning of the **General Care & Cleaning** section.

IMPORTANT CLEANING NOTE:

Liquid, cleaning towel or objects on the control area of the cooktop could cause the cooktop to display an error code or momentarily disable touch control operation.



Fig. 1

⚠ WARNING DO NOT use a cooktop cleaner on a hot cooktop. The fumes can be hazardous to your health, and can chemically damage the ceramic-glass surface. **Do not use commercial oven cleaners on any part of the cooktop. Damage to the finish or parts could result.**

Before You Call

- Solutions to Common Problems

Before you call for service, review this list. It may save you time and expense. The list includes common occurrences that are not the result of defective workmanship or materials in this appliance.

OCCURRENCE	POSSIBLE CAUSE/SOLUTION
Entire cooktop does not operate	Cooktop controls are locked. Set the cooktop controls to unlock the Cooktop (See p. 11 for further instructions).
	Make sure household electrical circuit breaker is ON and that power is properly supplied to the Cooktop.
	Service wiring is not complete. Call 1-800-4-MY-HOME® for installation assistance (See back cover).
	Electrical power outage. Check house lights to be sure. Call your local electric company for service.
Cooktop turns OFF while cooking	The automatic shut-off feature will turn all of the Cooking Zones and the entire Cooktop OFF after any Cooking Zone has been in continuous use for 18 hours.
	Cooktop internal heat sensor has detected high temperatures inside the appliance. Be sure the appliance vent holes are not blocked. Refer to the Installation Instructions supplied with the cooktop for more detailed cooktop installation information.
	Fluids spilled or object lying on controls area of cooktop. Clean spills or remove object. Repower cooktop.
Cooking Zone does not heat food	No cookware was placed on the Cooking Zone, or the cookware material type is incorrect for Induction Cooking.
	Cookware bottom not large enough for Cooking Zone.
	Cookware is warped or in poor condition.
	Cookware is not centered on Cooking Zone.
	Cookware resting on cooktop trim or does not rest completely on cooktop surface.
	No power to the appliance. Check steps under " Entire cooktop does not operate " in this checklist.
	Incorrect Cooking Zone control setting. Make sure the correct control is ON for the Cooking Zone being used.
Cooking Zone heats food too hot or not hot enough	Incorrect power level setting. Adjust the power level setting higher or lower and refer to recipe for guidance and adjust accordingly.
Food does not heat evenly	Lightweight or warped pans were used. Be sure to use good quality cookware.
	Use only flat bottom, evenly balanced medium or heavyweight cookware. Heavy and medium weight pans heat evenly. Because lightweight pans heat unevenly, foods may burn more easily (See p. 8 for further information).
	Adjust Cooking Zone power level setting until the proper amount of heat is obtained.
Poor cooking results	Many factors affect cooking results. Adjust the recipe's recommended power levels or cooking times.
	Cookware is too lightweight or warped. Use heavier quality cookware so foods being prepared may cook more evenly.



Before You Call

- Solutions to Common Problems (cont'd)

OCCURRENCE	POSSIBLE CAUSE/SOLUTION
Cooktop Zone Control displays E and LED Main Control displays a 2 digits error code.	Induction Cooktop main control has detected a fault or error condition. Try turning electrical power supply OFF and back ON to cooktop in order to reset Cooktop main controls. If fault recurs, record fault number and turn power supply to Cooktop OFF. Call 1-800-4-MY-HOME ® for assistance (See back cover).
Cooking Zone LED continuously flashes F	<p>Induction Cooktop pan detection sensors do not see the correct cookware. Test with a magnet to be sure cookware is made with Induction compatible material.</p> <p>Cookware has been removed from the Cooking Zone without turning the Cooking Zone OFF. Place cookware back on to the Cooking Zone or if finished cooking turn off the affected Cooking Zone.</p> <p>Cookware is not centered over the Cooking Zone properly. Refer to Fig. 20 for correct cookware placement.</p>
Metal marks on ceramic cooktop surface	Sliding or scraping of metal utensils on cooktop surface. DO NOT slide cookware or cooking utensils across the cooktop surface. Use the recommended ceramic glass cooktop cleaning creme to remove the marks. See "Cooktop Cleaning & Maintenance" in the General Care & Cleaning section (Refer to p. 13).
Scratches or abrasions on ceramic cooktop surface	<p>Coarse particles such as salt or sand between cooktop and cookware or cooking utensils can cause scratches. Be sure cooktop surface and bottoms of utensils are clean before placing on cooktop. Small scratches do not affect cooking and will become less visible with time.</p> <p>Cleaning materials not recommended for ceramic-glass cooktop have been used. See "Cooktop Cleaning & Maintenance" in the General Care & Cleaning section.</p> <p>Cookware with rough bottoms was used. Use smooth, flat-bottomed cookware ONLY.</p>
Brown streaks or specks on ceramic cooktop surface	Boil overs are cooked onto cooktop surface. Use a razor blade scraper to remove soil. See "Cooktop Cleaning & Maintenance" in the General Care & Cleaning section (Refer to p. 13).
Areas of discoloration with metallic sheen on ceramic cooktop surface	Mineral deposits from food and/or water. Remove using a ceramic-glass cooktop cleaning creme. Remember to use cookware with clean, dry bottoms. For more information See "Cooktop Cleaning and Maintenance" in the General Care & Cleaning section.



PROTECTION AGREEMENTS

Master Protection Agreements

Congratulations on making a smart purchase. Your new Kenmore® product is designed and manufactured for years of dependable operation. But like all products, it may require preventive maintenance or repair from time to time. That's when having a Master Protection Agreement can save you money and aggravation.

The Master Protection Agreement also helps extend the life of your new product. Here's what the Agreement* includes:

- ☑ **Parts and labor** needed to help keep products operating properly **under normal use**, not just defects. Our coverage goes **well beyond the product warranty**. No deductibles, no functional failure excluded from coverage – **real protection**.
- ☑ **Expert service** by a force of more than **10,000 authorized Sears service technicians**, which means someone you can trust will be working on your product.
- ☑ **Unlimited service calls and nationwide service**, as often as you want us, whenever you want us.
- ☑ **«No-lemon» guarantee** – replacement of your covered product if four or more product failures occur within twelve months.
- ☑ **Product replacement** if your covered product can't be fixed.
- ☑ **Annual Preventive Maintenance Check** at your request – no extra charge.
- ☑ **Fast help by phone** – we call it **Rapid Resolution** – phone support from a Sears representative on all products. Think of us as a «talking owner's manual».
- ☑ **Power surge protection** against electrical damage due to power fluctuations.
- ☑ **\$250 Food Loss Protection** annually for any food spoilage that is the result of mechanical failure of any covered refrigerator or freezer.
- ☑ **Rental reimbursement** if repair of your covered product takes longer than promised.
- ☑ **10% discount** off the regular price of any non-covered repair service and related installed parts.

Once you purchase the Agreement, a simple phone call is all that it takes for you to schedule service. You can call anytime day or night, or schedule a service appointment online.

The Master Protection Agreement is a risk free purchase. If you cancel for any reason during the product warranty period, we will provide a full refund. Or, a prorated refund anytime after the product warranty period expires. Purchase your Master Protection Agreement today!

Some limitations and exclusions apply. For prices and additional information in the U.S.A. call 1-800-827-6655.

* Coverage in Canada varies on some items. For full details call Sears Canada at 1-800-361-6665.

Sears Installation Service

*For Sears professional installation of home appliances, garage door openers, water heaters, and other major home items, in the U.S.A. or Canada call **1-800-4-MY-HOME**®.*

Acuerdos maestros de protección

Enhorabuena por haber hecho una compra inteligente. Su nuevo producto Kenmore® está diseñado y fabricado para brindarle años de funcionamiento fiable. Pero, como cualquier producto, puede necesitar mantenimiento preventivo o reparaciones periódicas. Es por eso que tener un Acuerdo maestro de protección podría ahorrarle dinero y molestias.

El Acuerdo maestro de protección también sirve para prolongar la durabilidad de su nuevo producto. El acuerdo* incluye lo siguiente:

- ☑ **Piezas y mano de obra** necesarias para contribuir a mantener el funcionamiento adecuado de los productos **utilizados en condiciones normales de uso**, no sólo en caso de defectos de los productos. Nuestra cobertura va **mucho más allá que la garantía del producto**. No se aplican deducibles ni exclusiones por fallas del funcionamiento: es decir, **verdadera protección**.
- ☑ **Servicio técnico por expertos** (más de **10000 técnicos autorizados de Sears**), lo cual significa que quien repare o realice el mantenimiento de su producto será un profesional de confianza.
- ☑ **Servicio técnico a escala nacional y número ilimitado de llamadas de solicitud de servicio técnico**: se puede poner en contacto con nosotros cuantas veces lo desee y cuando lo desee.
- ☑ **Garantía «sin sorpresas»**: se reemplaza el producto cubierto por el acuerdo si ocurren cuatro o más fallas del producto en un periodo de 12 meses.
- ☑ **Reemplazo del producto**: en caso de que no se pueda reparar el producto cubierto por el acuerdo.
- ☑ **Revisión anual preventiva de mantenimiento del producto**: puede solicitarla en cualquier momento, sin costo alguno.
- ☑ **Rápida asistencia telefónica**, la cual denominamos **Solución rápida**: es decir, asistencia telefónica a través de cualquiera de nuestros representantes de Sears, sobre cualquiera de nuestros productos. Piense en nosotros como en un «manual parlante del usuario».
- ☑ **Protección contra fallas eléctricas**, contra daños debidos a fluctuaciones de la corriente eléctrica.
- ☑ **\$250 al año para cubrir cualquier posible deterioro de alimentos** que haya tenido que desechar debido a una falla mecánica de cualquiera de nuestros refrigeradores o congeladores cubiertos por este acuerdo.
- ☑ **Devolución de gastos de alquiler de electrodomésticos** si la reparación de su producto asegurado toma más que el tiempo prometido.
- ☑ **10% de descuento** aplicable tanto a los costos del servicio de reparación, como de las piezas instaladas relacionadas que no hayan quedado cubiertos por este acuerdo.

Una vez que haya realizado el pago de este acuerdo, bastará una simple llamada telefónica para concertar una visita de servicio. Puede llamar a cualquier hora del día o de la noche, o bien concertar una visita de servicio por Internet.

La adquisición del Acuerdo maestro de protección es una inversión exenta de riesgos. Si por cualquier motivo decide cancelar dicho acuerdo durante el periodo de garantía del producto, le haremos un reintegro total del valor. O bien un importe proporcional si cancela el acuerdo en cualquier otro momento posterior al vencimiento del periodo de garantía del producto. ¡Adquiera hoy mismo su Acuerdo maestro de protección!

Algunas limitaciones y exclusiones podrían aplicarse. Para solicitar precios e información adicional, llame al 1-800-827-6655 (en los EE.UU.).

* La cobertura en Canadá varía en el caso de algunos artículos. Para obtener detalles completos al respecto, llame al 1-800-361-6665 de Sears de Canadá.

Servicio de instalación de Sears

*Para solicitar la instalación por profesionales de Sears de electrodomésticos, abridores de puertas de garaje, calentadores de agua y otros artículos de uso prioritario en el hogar, llame al **1-800-4-MY-HOME** en los EE.UU. o Canadá.*

Get it fixed, at your home or ours!

Your Home

For expert troubleshooting and home solutions advice:

manage my home

www.managemyhome.com

For repair – **in your home** – of **all** major brand appliances, lawn and garden equipment, or heating and cooling systems, **no matter who made it, no matter who sold it!**

For the replacement parts, accessories and owner's manuals that you need to do-it-yourself.

For Sears professional installation of home appliances and items like garage door openers and water heaters.

1-800-4-MY-HOME[®] (1-800-469-4663)

Call anytime, day or night (U.S.A. and Canada)

www.sears.com www.sears.ca

Our Home

For repair of carry-in items like vacuums, lawn equipment, and electronics, call anytime for the location of your nearest

Sears Parts & Repair Service Center

1-800-488-1222 (U.S.A.)

www.sears.com

1-800-469-4663 (Canada)

www.sears.ca

To purchase a protection agreement on a product serviced by Sears:

1-800-827-6655 (U.S.A.)

1-800-361-6665 (Canada)

Para pedir servicio de reparación a domicilio, y para ordenar piezas:

1-888-SU-HOGAR[®]

(1-888-784-6427)

Au Canada pour service en français:

1-800-LE-FOYER^{MC}

(1-800-533-6937)

www.sears.ca

Sears