

Breville®

Turn **on** your creativity



2 slice deep fill
sandwich toaster

READ CAREFULLY AND KEEP FOR FUTURE REFERENCE











This appliance can be used by children aged from 8 years and above and persons with reduced physical, sensory or mental capabilities or lack of experience and knowledge if they have been given supervision or instruction concerning use of the appliance in a safe way and understand the hazards involved. Children shall not play with the appliance. Cleaning and user maintenance shall not be made by children unless they are older than 8 and supervised.

Keep the appliance and its cord out of reach of children less than 8 years old.

Never operate the appliance by means of an external timer or separate remote-control system.

 **Do not touch the metal parts of the appliance during use as they may become very hot.**

If the supply cord is damaged, it must be replaced by the manufacturer, its service agent or similarly qualified persons in order to avoid a hazard.

-  Never use this appliance for anything other than its intended use. This appliance is for household use only. Do not use this appliance outdoors.
-  Always ensure that hands are dry before handling the plug or switching on the appliance.
-  Always use the appliance on a stable, secure, dry and level surface.
-  Care is required when using the appliance on surfaces that may be damaged by heat. The use of an insulated pad is recommended.
-  This appliance must not be placed on or near any potentially hot surfaces (such as a gas or electric hob).
-  Never let the power cord hang over the edge of a worktop, touch hot surfaces or become knotted, trapped or pinched.
-  Do not use the appliance if it has been dropped or if there are any visible signs of damage.
-  Ensure the appliance is switched off and unplugged from the supply socket after use and before cleaning.
-  Always allow the appliance to cool before cleaning or storing.
-  Never immerse any part of the appliance or power cord and plug in water or any other liquid.
-  Never leave the appliance unattended when in use.

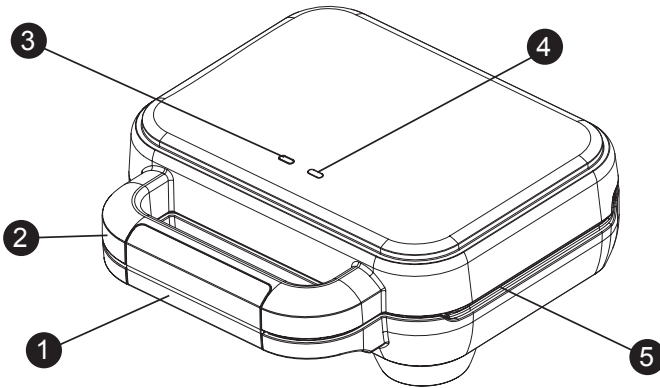

- 1 Latch - holds the lid firmly closed during cooking**
- 2 Handle**
- 3 Green power light**
- 4 Amber ready to cook light**
- 5 Non-stick cooking plates with cut & seal action**

Before first use

- Unpack your sandwich toaster. You may wish to keep the packaging for future use.
- Wipe the cooking plates with absorbent paper or a soft damp cloth.
- Clean the outside of your sandwich toaster with a soft damp cloth which has been wrung almost dry in warm soapy water. The cover can be polished with a soft dry cloth.

Note that the first time you use your sandwich toaster, you may notice a slight burning smell and a little smoke. This is completely normal and will soon disappear.

using your sandwich toaster

Recipe ideas

Making toasties is easy and fun, they can be as creative or as simple as you like and make great snacks whether eaten at home or on the go.

Using basic ingredients delicious sweet or savoury meals can be made in minutes, perfect for any time of the day. Here are some classic toasted sandwich recipes that you may wish to try.

- Tuna Melt (tuna, onion, mayonnaise and cheese)
- Cheese and tomato
- Cheese, beans and ham
- Turkey, stuffing and cranberry
- Ham, Brie, mushrooms and rocket
- Steak and mushrooms
- BLT (bacon, lettuce and tomato)
- Bacon and cheese
- Chicken, red pepper and Brie
- Sweet chilli chicken
- Sausage and scrambled eggs
- Camembert and cranberry
- Chocolate and banana
- Banana and plum
- Toffee and apple

Breads

For best results, use a supermarket own-label, medium, white sliced bread. For variety, why not try using wholemeal bread, Danish-style bread, seeded breads, sour dough and fruit breads.

Cheeses

Classic cheeses that melt easily like Cheddar, Gruyere and Emmental make excellent toasties. We've included some different cheeses in our recipes but why not experiment and get creative with your own favourite cheeses!

The perfect toastie

Even if you are already familiar with using a sandwich toaster, it's worth following the guidelines below.

1. Plug your sandwich toaster in to the mains supply socket and switch the socket on if required. The green power light will come on and your sandwich toaster will start heating up.
2. When your sandwich toaster is fully heated the amber ready-to-cook light will come on. This light will come on and go out during cooking.
3. Spread the OUTSIDE of the bread with butter or a spread suitable for cooking. Don't use a low fat spread or one which has a high water content.
4. Place the two lower slices of bread onto the bottom plate 'buttered' side down. Face the crusts of the bread to the left and right.

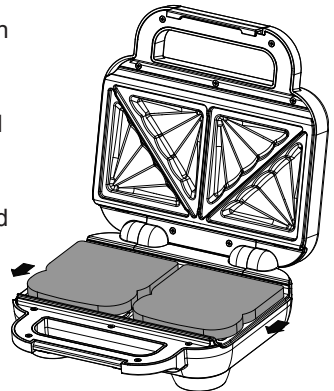

using your sandwich toaster

5. Add the filling. The deeper cooking plates allow you to use more of your favourite ingredients but always allow a 2cm gap around the filling as shown below. This will allow your sandwich toaster to form a good seal and prevent the filling from leaking out.

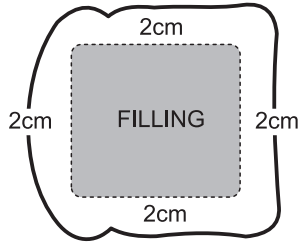

For best results, the maximum amount of cheese, when used as a single ingredient, should not exceed 60g. If you add other ingredients, reduce the amount of cheese to compensate for them.

6. Place the remaining bread on top with the buttered side on the outside (this will give your toastie a lovely golden colour during cooking).
7. Close and latch the lid and allow to cook for approx 4-5 minutes until golden and cooked. Leave the sandwich in the toaster for more or less time according to taste.
8. Release the latch and open the lid. Watch out for escaping steam—use a tea towel or wear oven gloves. Remove the cooked sandwich with a non-metallic spatula. Don't use a metal blade as this can damage the non-stick surface of the plates.
9. Once cooked, take care when eating as fillings, especially fruit or tomato, can be very hot.

Important points:

- Always allow a 2cm gap around the filling.
- Never overfill your toastie.
- Too much filling can leak out and also make the latch difficult to close.

NOTE: Using high % water based spreads or sauces may have impact on bread structure or surface during toasting cycle.

care and cleaning

▲ Unplug and switch off your sandwich toaster and allow it to fully cool down before cleaning it. Do not immerse the main body, cord set or plug in water or liquid of any kind.

Never use steel wool, scouring pads, abrasive cleaners or metallic utensils to clean your sandwich toaster.

1. Before cleaning your sandwich toaster, switch it off and unplug it from the mains supply. Allow it to cool down fully.
2. Wipe the cooking plates with an absorbent paper or soft damp cloth.
3. Clean the outside of your sandwich toaster with a soft damp cloth which has been wrung almost dry in warm soapy water. The cover can be polished with a soft dry cloth.

⚠ This appliance must be earthed.

This appliance must be earthed. If the plug is not suitable for the socket outlets in your home, it can be removed and replaced by a plug of the correct type. If the fuse in a moulded plug needs to be changed, the fuse cover must be refitted. The appliance must not be used without the fuse cover fitted.

If the plug is unsuitable, it should be dismantled and removed from the supply cord and an appropriate plug fitted as detailed. If you remove the plug it must not be connected to a 5 amp socket and the plug must be disposed of immediately. If the plug fuse requires replacement, a fuse of the same rating as that fitted by the manufacturer must be used. In order to prevent a hazard do not fit a fuse of a lower or higher rating.

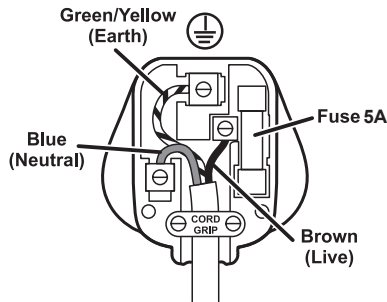

After sales service & replacement parts

In the case the appliance does not operate but is under warranty, return the product to the place it was purchased for a replacement. Please be aware that a valid form of proof of purchase will be required. For additional support, please contact our Consumer Service Department at **0800 028 7154** or email: **BrevilleEurope@newellco.com**.

Troubleshooting

For troubleshooting and FAQs visit www.breville.co.uk/faqs

Waste Disposal

Waste electrical products should not be disposed of with household waste. Please recycle where facilities exist. E-mail us at BrevilleEurope@newellco.com for further recycling and WEEE information.



Breville®

Jarden Consumer Solutions (Europe) Limited
5400 Lakeside, Cheadle Royal Business Park,
Cheadle, SK8 3GQ, United Kingdom
Newell Poland Services Sp. z o.o.,
Plac Andersa 7, Poznan, 61-894, Poland.
e-mail: BrevilleEurope@newellco.com
UK Telephone: 0800 028 7154

© 2021 Jarden Consumer Solutions (Europe) Limited. All rights reserved.
Jarden Consumer Solutions (Europe) Limited, 5400 Lakeside, Cheadle Royal Business Park,
Cheadle, Cheshire, SK8 3GQ, United Kingdom.
Newell Poland Services Sp. z o.o., Plac Andersa 7, Poznan, 61-894, Poland.
Jarden Consumer Solutions (Europe) Limited and Newell Poland Services Sp. z o.o. are
subsidiaries of Newell Brands Inc.
The product you buy may differ slightly from the one shown on this carton due to continuing
product development.
Made in China.