

PANALUX ALLEGRA C

Accurate, powerful, full-colour LED

TABLE OF CONTENTS

01 Introduction	03
About This User Manual	04
Related Documentation	04
Technical Support	04
Disclaimer	04
02 Important Information & Warning	05
Changes	06
Measuring Correlated Colour Temperature (CCT), Colour x y	06
Flicker-Free Filming	07
Gel/Filter Emulations and Source Matching	07
Safety Information	08
Ventilation	09
Additional Safety Considerations	09
03 System Overview	11
ALLEGRA-C™ System	12
ALLEGRA-C™ Heads	12
ALLEGRA-C™ Ballasts	14
Connections	15
Ballast Connections	16
04 Operation	17
Ballast User Interface	18
Factory Reset	18
Lock Mode	18
Rotary Encoder	19

Menu Buttons
Memory Buttons
Backlight
MENU
Important Note on Dimming Curves
Tungsten Emulate Mode
Output
Gamut
Control Priority

05 General

Ballast Characteristics
Head Characteristics
Fault Finding Tips
Spare Parts & Accessories

06 Appendix

ALLEGRA-C Menu Tree
DMX Personalities - Channel Assignments
Gels
Source Matching
Gel Library
Source Emulation List
RDM
ALLEGRA-C RDM Sensors
ALLEGRA-CTM 2:1 Overall Dimensions & Rigging Centres
ALLEGRA-CTM 2:2 Overall Dimensions & Rigging Centres
ALLEGRA-CTM 4:1 Overall Dimensions & Rigging Centres
ALLEGRA-CTM 4:2 Overall Dimensions & Rigging Centres



01

INTRODUCTION





INTRODUCTION

About This User Manual

This manual provides installation, operation, and maintenance instructions for all ALLEGRA-C™ professional lighting fixtures. This manual applies to the following software versions:

v2.22

Related Documentation

For more information regarding DMX512 systems, refer to the DMX512/1990 & AMX 192 Standards publication available from United States Institute for Theatre Technology, Inc. (USITT). Contact by post at USITT, 6443 Ridings Road, Syracuse, NY, 13206-1111, USA; by phone on 1-800-93USITT; or online at www.usitt.org.

Art-Net is used for transmitting DMX lighting control protocol and RDM over the User Datagram Protocol (UDP) of the Internet Protocol suite. It is based on the TCP/IP protocol suite and used to communicate between nodes/lighting fixtures and a lighting desk, typically on a private local network such as Ethernet. Art-Net can address over 30,000 universes.

Art-Net™ designed by and copyright Artistic Licence Holdings Ltd.

Technical Support

For technical support, contact Panalux on +44 20 8233 7000 or at info@panalux.biz

Disclaimer

Panalux and ALLEGRA-C™ are trademarks of PANAVISION registered in the U.S. and other countries. All other brand or product names which may be mentioned in this manual are trademarks or registered trademarks of their respective companies. This manual is for informational use only and is subject to change without notice. Please check www.panalux.biz for the latest version. Panalux assumes no responsibility or liability for any claims resulting from errors or inaccuracies that may appear in this manual.



02

IMPORTANT INFORMATION & WARNINGS





IMPORTANT INFORMATION

Changes

Panalux provides this manual 'as is' without warranty of any kind, either expressed or implied, including but not limited to the implied warranties or merchantability and fitness for a particular purpose. Panalux may make improvements and/or changes to the product(s) and/or the programmes described in this publication at any time without notice. This publication could contain technical inaccuracies or typographical errors. Changes are periodically made to the information in this publication; these changes are incorporated in new editions of this publication.

Measuring Correlated Colour Temperature (CCT), Colour x y

The ALLEGRA-C™ utilises an LED source that is optimized for the film, TV, and image capture industries. Older colour meters cannot be used to accurately read the Correlated Colour Temperature (CCT) of ALLEGRA-C™ and other discontinuous spectrum light sources. Older colour meters are designed for a full spectrum source such as incandescent lights. These meters possess only three sensors to measure the light output: red, green, and blue. As such, a narrow band or discontinuous spectrum light source may not read correctly. Colour meters such as the Sekonic C800 Spectromaster or UPR Tech MK 350 will provide excellent measurements and include TLCI and SSI metrics as standard.

Panalux have taken great care in ensuring that the CCT and colour spectrum of gel emulations of the light emanating from ALLEGRA-C™ closely matches traditional tungsten and discharge light sources. This allows you to easily place ALLEGRA-C™ alongside your traditional lighting fixtures. If in any doubt, it is the user's responsibility, as is customary, to shoot image capture tests when combining sources employing different core technology—such as HMI, florescent, tungsten, or simple RGB and bi-colour LED fixtures—to ensure compatibility. Shoot tests using the camera setup to be used for the project (capture gamut, LUTs, etc.). The spectral power density curve, chip profiles, and coordinates will be different from other fixtures. Matching x y coordinates will only guarantee proximity to the x y coordinates. It will not guarantee a colour match to eye or to camera with another light source.



Flicker-Free Filming

The only way to guarantee flicker-free filming at any frame rate and shutter angle is by using pure DC power, carbon arc sources, or daylight. There is a chance of flicker in every other scenario with artificial light, even with tungsten mains-powered fixtures.

Visible flicker is also affected by postproduction. Where the contrast is increased, the flicker becomes more visible.

ALLEGRA-C™ has been validated flicker-free at any dim position up to 10,000 fps. ALLEGRA-C™ has been tested across a range of dim settings, CCTs, and colours with the high-speed Vision Research Phantom camera as well as Arri Alexa Mini, with the cameras at multiple shutter angles. Not all manufacturers are as thorough. Test whenever in doubt, particularly when shooting high speed.

Flicker factor, the relationship between the maximum and minimum illuminance exhibited in the flicker, can be measured with a flicker meter. 100% means the light goes totally dark at minimum. HMI electronic ballasts tend to have a flicker factor around 1–3%, tungsten lights 0–10%.

With multi-colour LED fixtures, in particular older Stage and Architectural LED fixtures where compatibility with film and digital cameras wasn't a consideration in their design, individual colour channels can be out of sync, causing different colour mixes on different frames, which can cause issues with high-speed filming, stop-frame animation, and still photography.

If in doubt, test and review. Check the footage after running a test, and be aware that some digital cameras do not replay raw footage, so it is advisable to download files first and then check.

Gel/Filter Emulations and Source Matching

ALLEGRA-C™ comes pre-loaded with a range of LEE Filter gel emulations. Since the base spectrum of the ALLEGRA-C™ at 3200K and 5600K is not identical to a tungsten or daylight source, the gel presets are merely emulations. Due to the inherent technology, no LED bi-colour or multi-chip source can perfectly match the spectrum of a subtractive filter laid over a tungsten or daylight source. Even if the x y coordinates appear to be a good match, the spectrum will be different, and the camera will read subtle differences. If in doubt, test before shooting.

Safety Information

Please read through this manual carefully before operating the ALLEGRA-C™ system. Keep this manual for future reference. There are numerous safety instructions and warnings that must be adhered to for your own safety. ALLEGRA-C™ system is not intended for residential use. It is only intended for use in a professional studio. The ALLEGRA-C™ system must only be serviced by a qualified individual. The symbols below are used throughout this manual to identify important safety information.

SYMBOL	MEANING
	<p>Risk of electric shock / risk of fire</p> <p>Do not open. To reduce the risk of electric shock, do not remove cover (or back). No user serviceable parts inside. Refer servicing to qualified service personnel.</p>
	<p>Burning Injuries</p> <p>Be aware of high case temperatures of 60-85°C during and after use of ALLEGRA-C™. Don't touch the metal cases, frames or LED's to avoid burning issues.</p>
	<p>Flammable Materials</p> <p>Keep flammable materials away from the installation. The installation should be such that the amount of air flow required for safe operation of the equipment is not compromised. Proper ventilation must be provided.</p>
	<p>ESD and LEDs</p> <p>LED components used in ALLEGRA-C™ are sensitive to electro-static discharge (ESD). To prevent the possibility of destroying LED components do not touch during operation or when ALLEGRA-C™ is switched off.</p>
	<p>Light output</p> <p>Due to high light-output intensity do not look directly into the bare LED array. Use diffusers when exposing the light to human eyes.</p>
	<p>This equipment MUST be earthed</p> <p>In order to protect against risk of electric shock, the installation should be properly grounded. Defeating the purpose of the grounding type plug will expose you to the risk of electric shock.</p>
	<p>Mains cords</p> <p>Use only a Neutrik PowerCon TrueOne NAC3FX-W-TOP Connector. The user is responsible for ensuring power cables are of adequate condition for each application. If the power cords are damaged, replace them only with new ones. Never try to repair a power cord.</p>
	<p>Environmental: Disposal of old electrical & electronic equipment</p> <p>This symbol on the product or on its packaging indicates that this product shall not be treated as household waste.</p>



Ventilation

1. Do not use the ALLEGRA-C™ system outdoors or in a wet environment without approved accessories.
2. Keep the ALLEGRA-C™ system a minimum distance of 0.1m (4 inches) away from flammable materials/objects.

Additional Safety Considerations

1. ALLEGRA-C™ system is rated as IP40, for indoor use and in a dry environment.
2. ALLEGRA-C™ system is not certified for use in hazardous locations.
3. ALLEGRA-C™ system operating temperature is within the range of 0 to 40°C (32 to 104°F).
4. Do not connect to a variable power supply such as a dimmer rack or variac.
5. Use only approved spare parts and accessories. (Refer to Spare Parts/Accessories list on page 37.)
6. Do not open the ALLEGRA-C™ system when powered. Allow the ALLEGRA-C™ system to cool before servicing, as internal parts may be hot.
7. Do not alter the design of the ALLEGRA-C™ system or tamper with any of the safety features.
8. Do not look directly into ALLEGRA-C™ bare light source as it may be harmful to the eyes.
9. The ALLEGRA-C™ system's surfaces can become hot. Please ensure contact on the surface by persons or materials is avoided when the fixture is operating. Do not operate ALLEGRA-C™ if there are any signs of physical damage. If damage is visible or suspected, contact Panalux Engineering Dept.
10. Before using ALLEGRA-C™, check for any of the defects listed in the table below.

Part	Possible Defect
Power Cable	Physical damage, cut, burnt
Header cable	Physical damage
Connectors	Damaged, loose
Safety fixings	Damaged, loose
Casings	Physical damage





	Approvals
EU	EN 55015:2013 EN 61547:2009 EN 61000-3-2:2014 EN 61000-3-3:2013 EN 61000-4-2:2009 EN61000-4-3:2006+A1:2008+A2:2010 EN 61000-4-4:2012 EN 61000-4-5:2006 EN 61000-4-6:2009 EN 61000-4-8:2010 EN 61000-4-11:2004
FCC	47 CFR of part 15
CSA and UL	CSA C21.0 No. 250.4-14 CAN/CSA C21.0 No. 250.13-14 UL Standard No. 153 UL Standard No. 8750

	Certifications
ROHS	EPA3050B:1996 EN1122B:2011 EPA3052:1996 EPA7196A:1992 APE3540C:1996 EPA8270D:2007
Europe	EN / IEC 62471

Note

ALLEGRA-C™ system has been built to conform to international regulatory standards relating to professional lighting equipment. Any modification made to the ALLEGRA-C™ system will void the manufacturers' warranty.





04

SYSTEM OVERVIEW

SYSTEM OVERVIEW

ALLEGRA-C™ System

Each ALLEGRA-C™ system comprises a head and a ballast. The sections below provide information on each in turn.

ALLEGRA-C™ Heads

ALLEGRA-C™ heads are powerful light fixtures that incorporate Panalux's high-quality proprietary LED arrays. This LED source provides the user with a large volume of high-quality white light at a stable and repeatable CCT, emulating traditional sources and a vast array of colours, LEE filter emulations and tints.

Head Fixings:

All ALLEGRA-C™ heads are provided with a Kino mount receptacle on the rear face as the primary fixing method. A Kino mount universal joint, incorporating a 16mm receiver is included in the ALLEGRA-C™ kit. For an alternative method of hanging ALLEGRA-C™ heads, eyelets are present on the fixture for attaching rigging ropes in each corner. Ensure the ropes are securely attached to ALLEGRA-C™ head before rigging.

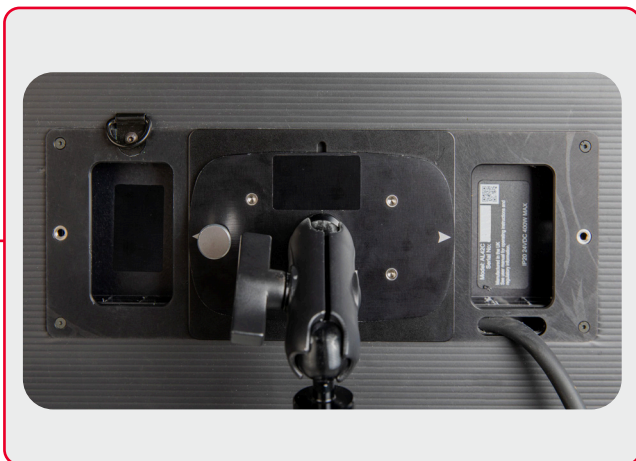

Head Safety:

When hanging an ALLEGRA-C™ head, a safety cable should be attached to the D-ring on the rear of the fixture.

The combined weight of ALLEGRA-C™ head should be considered when choosing suitable safety bond(s). The safety bond assembly should be rated at the combined weight of the head and accessories present. head weights can be found in the **Physical Characteristics** section of the manual.



Head Connections:

1. The ALLEGRA-C™ head is connected to its ballast via a 2m tail, terminated with a Neutrik 8+2 XLR.
2. A 4m extension cable is included in the kit. Do not use extensions of more than 8m, as the head may not function correctly.
3. Ensure the connection cable and any other cables are routed carefully to avoid snagging & pulling.



ALLEGRA-C™ Ballasts

ALLEGRA-C™ ballasts are available in two sizes. 450C, which is capable of powering two ALLEGRA-C™ heads and the 250C, that can power a single ALLEGRA-C™ head. Both ballasts incorporate a mains power supply and the Panalux proprietary user interface and controller.



Ballast Fixings:

ALLEGRA-C™ ballasts are provided with a Kino mount receptacle on the underside as the primary fixing method. A Kino mount universal joint, incorporating a 16mm receiver is included in the ALLEGRA-C™ kit.

For an alternative method of hanging ALLEGRA-C™ ballasts, two M6 threaded holes are present on the underside of the ballast, for attaching eye bolts or other appropriate fixings. Ensure any fixings are securely screwed into the ALLEGRA-C™ ballast before rigging

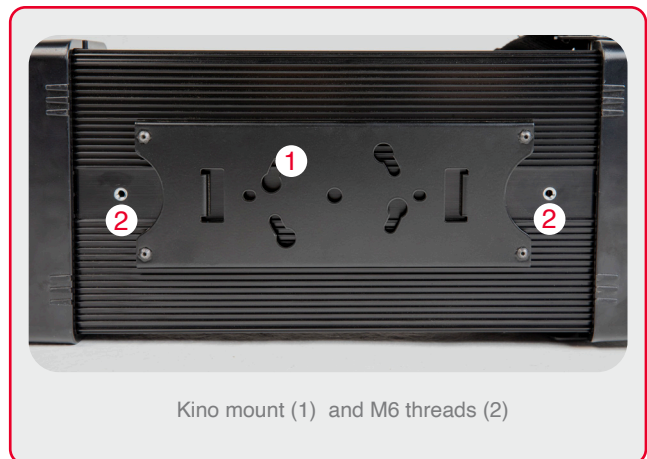

Ballast Safety:

When hanging an ALLEGRA-C™ ballast, an M6 eye-bolt should be fitted and a safety cable should be attached to it.

The combined weight of ALLEGRA-C™ ballast should be considered when choosing suitable safety bond(s). The safety bond assembly should be rated at the combined weight of the head and accessories present. Ballast weights can be found in the Physical Characteristics section of the manual.



Connections



- 1 Head A output
- 2 Head B output
- 3 Mains in
- 4 DC in
- 5 Mains on/off switch
- 6 Mains fuse
- 7 DMX in
- 8 DMX out

BALLAST CONNECTIONS

Power

ALLEGRA-C™ ballasts are fitted with two power inlets:

A Neutrik powerCON TRUE1 NAC3MPX-TOP type connector for mains power.

This inlet is switched and fused. The power cable should be plugged into ALLEGRA-C™ before switching the mains power supply ON. The mains power supply should be switched OFF before removing the power cable. Use only Neutrik connectors for power cords. It is the user's responsibility to ensure the power cord is maintained in good condition and any physical damage is addressed.

A Neutrik 3 pin XLR connector for a 24 - 36V DC source.

Ensure that the input voltage does not exceed 36V, otherwise damage to the ballast may result. DC wiring is as follows:

- Pin 1:** 0V
- Pin 2:** 24 - 36VDC
- Pin 3:** NC

The ALLEGRA-C™ ballast switches automatically between AC and DC power. If AC and DC power is applied at the same time, the ALLEGRA-C™ ballast will use the AC source.

Head Outputs

A Neutrik 8+2 pole XLR provides data and power to the ALLEGRA-C™ head. Allegra 250C ballasts have 1 output and Allegra 450C ballasts have 2 outputs. When driving one head from an Allegra 450C ballast, use output A.

Data Inputs

ALLEGRA-C™ uses industry standard 5-pin XLR male and female connectors to receive and output DMX signals. The DMX wiring is as follows:

- Pin 1:** Ground
- Pin 2:** Data +
- Pin 3:** Data –
- Pin 4:** Spare
- Pin 5:** Spare

Please note: ALLEGRA-C™ is self-terminating and does not require external DMX termination when used in a chain

Accessories

The ALLEGRA-C™ system has a range of accessories:

- Power cord**
- Aerial**
- Spill skirt**
- Snapgrid® Eggcrate**
- Quarter Grid Cloth**
- Half Grid Cloth**
- Full Grid Cloth**
- Magic Cloth**
- Kino mount universal 16mm receiver**
- M6 Eye-bolt**



04

OPERATION

OPERATION

Ballast User Interface

ALLEGRA-C™ ballast provides control over the intensity, colour temperature, green/magenta bias, hue and saturation, x y coordinates, RGB, and a range of other parameters for precision control.

Control is via the local user interface on the front of the ballast, DMX, or Wireless connection.

In all modes, the **status bar** will show the current state of:

- DMX Base Address**
- DMX Personality**
- DMX Control Source** (wired, wireless, local)
- Control priority** (int, ext, LTP)
- 'LOCKED'** (when local control is locked)
- 'DEMO'** (when fixture is cycling through a demo)



In white mode (shown above), the display will always show:

- Dim Position** (percentage)
- CCT**
- Green/Magenta Bias**

Factory Reset

Factory reset and clearing all memory presets is achieved by holding down the bottom left and bottom right buttons together while cycling the power.

WARNING. ALL STORED PRESETS WILL BE ERASED.

Lock Mode

The local controls can be locked and unlocked by holding down the bottom left button for 2 seconds. 'LOCKED' will be shown top centre of the display when local control is disabled.

To release LOCKED status and DEMO status, hold down bottom left button.

Rotary Encoder

The encoder enables scrolling forwards or backwards through the 'live' highlighted menu item. Also, by pushing the encoder, you are able to jump through presets. It is also used to navigate menus.

'Push' to confirm selection

See rotary encoder presets below:

Value	Presets												
Dim	25%	50%	75%	100%									
CCT	1700K	2700K	2900K	3200K	3600K	4300K	5000K	5600K	6500K	7700K	10000K	15000K	20000K
G/M	1/8 +G	1/4 +G	1/2 +G	3/4 +G	1 +G	N/C	1 -G	3/4 -G	1/2 -G	1/4 -G	1/8 -G		

After 5 seconds, the encoder always defaults to dimmer in any mode.

The encoder features a ballistic algorithm. The slower it is rotated the higher the resolution. The faster it is rotated the faster it scrolls through the CCT range or gel.

When controlling the dimming this allows ultra-fine control down to 0.1% steps.



Menu Buttons

There are 4 quick menu buttons below the screen. In WHITE MODE the first 3 allow the user to assign the encoder to alter key attributes: DIM, CCT, and green/magenta bias (G/M). The fourth selector button (bottom right) is dedicated to MENU selection or BACK functions.

Memory Buttons

The 4 memory buttons above the screen are reserved for storing user defined scenes.

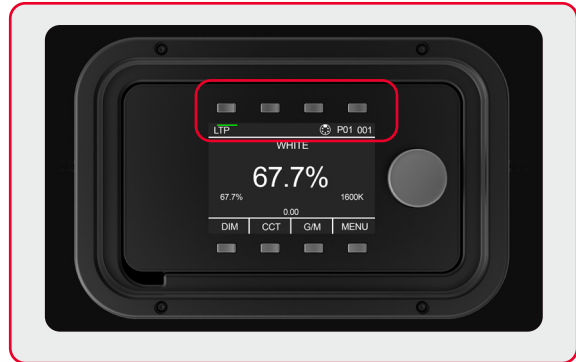

To store a scene, push and hold any of the 4 buttons until the screen flashes **SAVED**. All scene settings will be saved. For example, in **WHITE MODE**, dim percentage, CCT, and green/magenta bias will be saved.

A green bar below a memory button indicates a stored scene. A single button press displays the stored settings without changing the output, and the bar will turn red. A second press will change the output.

Black or 0% dim can also be stored to enable a rapid cut to black facility from local control, achieved with a quick double tap of the preset button.

WARNING: The scene memory can be overwritten. Restoring to factory default will permanently erase all user-memory settings.

Backlight

The controller screen's backlight activates on user interaction, local or from DMX. After 30 seconds of inactivity it deactivates with a slow fade to 10% brightness.



MENU

One push of the menu button (bottom right) enables the menu. If the menu button is not visible, repeatedly press the back button until it appears.

DMX ADDRESS

Rotate the encoder to select the required DMX address and press the encoder to store it. The DMX address is displayed on the right of the info bar at the top of the screen:



PERSONALITY

DMX personalities determine how the ALLEGRA-C™ ballast behaves in relation to DMX control and the number of channels one fixture will occupy. The selected personality is always shown on the top status bar. ALLEGRA-C™ has 19 available DMX personalities.

Personality	Type	Channels
P1	White 8 bit	3
P2	White 16 bit	5
P3	HSI 8 bit	4
P4	HSI 16 bit	8
P5	Gel 24 bit BCD	6

Personality	Type	Channels
P6	Gel 16 bit	5
P7	Gel Hue 24 bit BCD	8
P8	Gel Hue 16 bit	11
P9	RGB 8 bit	4
P10	RGB 16 bit	8

Personality	Type	Channels
P11	x y 16 bit	8
P12	x y 24 bit BCD	10
P13	Ultra	7
P14	Extreme	10
P15	Crossfade white to colour	9

Personality	Type	Channels
P16	Crossfade white to RGB	8
P17	Crossfade white to gel	13
P18	Crossfade gel to gel	20
P19	Crossfade xy to xy	15

See appendix for personality channel assignments

COLOUR

The colour menu allows selection of the five ALLEGRA-C™ colour modes. White, Gel, HIS, RGB and xy. White, Gel and HIS modes are also available using the quick menu buttons at the bottom of the screen.

WHITE allows white point control along the Black Body Locus (BBL) from 1600K – 20,000K and green/magenta bias above and below that Locus.

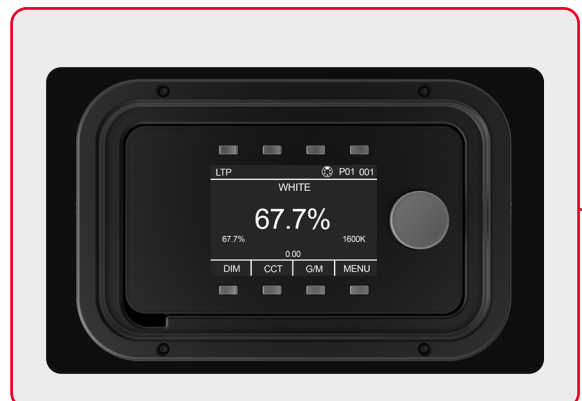

HSI mode allows the user to control the hue angle and saturation against a set white point.



GEL mode accesses a selection of LEE filter emulations sortable by chroma, name, or number.

In this screen, the live highlighted bottom button (NAME in the top-left example image) allows toggling of LIVE ON and LIVE OFF. In LIVE OFF mode, you can scroll through a range of colours without changing the output until selected. In LIVE ON mode, the output will change actively whilst scrolling through the gel list.



Gel numbers highlighted with a RED background are outside of selected gamut and are desaturated. See gamut section below.

RGB Repeatedly pressing the RGB button toggles control between Red, Green and Blue.



x y mode allows the user to select an x y coordinate on the CIE 1931 chromaticity chart.

If the chosen colour point is out of gamut, ALLEGRA-C™ will shut off its output and the font will turn red.

The light will switch off during adjustment as soon as the requested coordinate is unachievable. If the coordinates selected go out of achievable gamut, the coordinate font will turn red.



SOURCE

The source menu allows the user to select between wired, wireless or primary/clone control.

WIRED ALLEGRA-C™ will show the XLR symbol on the info bar and will respond to DMX control signals on the DMX socket. The XLR symbol will turn blue when a valid DMX signal is present. DO NOT CONNECT WIRELESS AND WIRED DMX SIGNALS AT THE SAME TIME AS THE FIXTURE MAY BEHAVE ERRATICALLY.



WIRELESS In wireless mode, ALLEGRA-C™ will attempt to pair with a CRMX wireless transmitter and the wireless symbol on the info bar will flash. Once paired, the wireless symbol on the info bar will become solid green. To un-pair, press the unlink button and ALLEGRA-C™ will immediately start to search for a new transmitter. Do not use wireless mode with wired DMX connected, or the fixture may behave erratically.



PRIMARY/CLONE When selected, ALLEGRA-C™ will become the primary fixture and a network symbol will be displayed on the info bar. In this mode, any ALLEGRA-C™ connected to the primary, via the DMX sockets, will copy its behaviour.

All ALLEGRA-C™ systems in the chain must be set to the same DMX personality.

CONTROL

The control menu allows selection of dimming curves, output power, colour gamuts and the priority of control signals.



CURVES

Curve	Characteristics
Linear (Default)	In linear mode, 50% equates to half the output, or 1 stop down . 25% is quarter output, or 2 stops down .
Square Law	A square law curve increases the dimming resolution at lower control levels.
S Curve	S Curve provides a finer control at lower and higher levels while offering coarse control (lower resolution) at medium levels. This dimming curve best emulates a typical incandescent lamp's dimming abilities.
Tungsten Emulate	Tungsten emulate mode combines square law with greater resolution at lower levels and a warming of the CCT as the fixture dims. This operates on any CCT start point between 2700K and 3600K (correlating to an underrun and overrun tungsten bulb). At CCTs outside this range, standard square law is in play.



Important Note on Dimming Curves

It is important for consistency that all ALLEGRA-C™ systems in a DMX rig are set to the same dimming curve. If set to different dimming curves, fixtures on the same address, output won't track with a global dim command.

Tungsten Emulate Mode

Tungsten Emulate reference values are as below:

Dim	CCT	Dim	CCT	Dim	CCT
100%	3200K	100%	3600K	100%	2700K
85%	3000K	86%	3400K	80%	2480K
71%	2800K	74%	3200K	60%	2220K
58%	2600K	63%	3000K	40%	1920K
48%	2400K	52%	2800K	30%	1760K
38%	2200K	35%	2600K	25%	1695K
31%	2000K	28%	2400K	10%	1600K

Output

The ALLEGRA-C™ system has two power output modes, BOOST (default) and FLAT. Due to the inherent efficacy difference between warm white and cold white chips, the photometric output changes at different CCTs.

In a studio environment where multiple changes are made to CCT, it is often advantageous that the photometric output remains constant. This is achieved in FLAT mode and is active only in WHITE MODE and only between 2700K and 7000K.

In BOOST mode, maximum output is available, which may be advantageous when working in environments with ambient daylight.



Gamut

The ALLEGRA-C™ heads output gamut can be restricted to the bounds of REC 2020, REC 709, DCI P3, ESTA 1.54 or Panalux Vari-white, to match the Sonara range of heads. Due to the different overlaps of the gamuts, selecting REC 709 or REC 2020 will restrict some of ALLEGRA-C™ output in certain zones.

For example, as can be seen in the illustration below, the ALLEGRA-C™ head is capable of producing a range of colours in the yellow and deep amber zone that wouldn't be captured in REC 709. In x y mode with REC 709 as the selected gamut, ALLEGRA-C™ would not output a colour at those x y coordinates, which would be shown in a red font on the display.

In CCT, HSI, RGB, or GEL mode, if the colour is unachievable due to the chosen gamut, the colour produced will be desaturated towards the selected white point

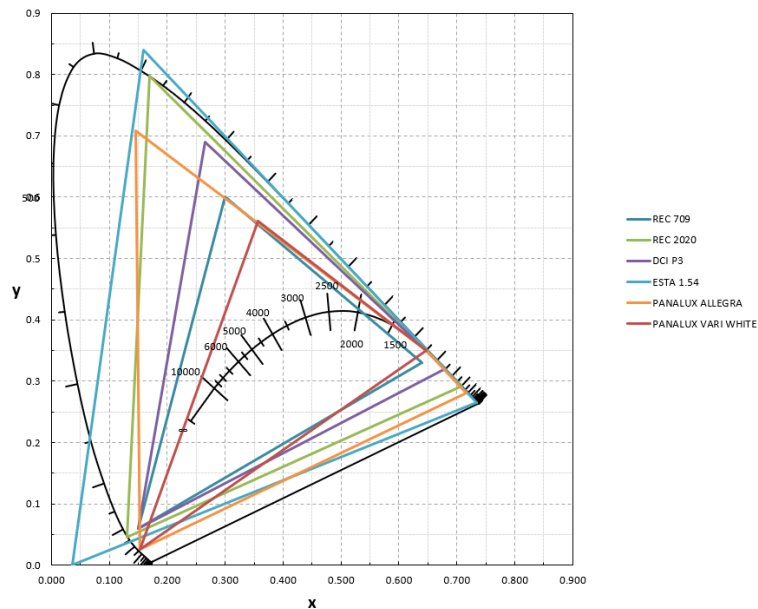

CIE 1931 Chromaticity Diagram showing gamut comparison between ALLEGRA-C™ Vari-White and other common colour spaces.



Control Priority

The ALLEGRA-C™ ballast can be controlled by local user interface or by external control (wired or wireless).

3 control priority modes are available, detailed below:

Mode	Characteristics
LTP (Default)	Last Takes Precedence. In LTP mode, the ALLEGRA-C™ ballast will listen to DMX (wired or wireless), Art-Net, and the local User Interface, and will take instructions from any. This allows a DOP or gaffer to 'ride' the dimmer when the talent is moving to a cue, or during setup to make changes whilst talking to the board operator, who may be backstage.
External	Ignores local control and locks the User Interface. To exit this mode, hold down the bottom left button for 5 seconds and the display will go to Control Priority Menu.
Local	Ignores any external input even if wired to DMX.





05

GENERAL

General Information

Ballast Characteristics

Part	450C	250C
Dimensions(W x H x D)	210x108x448 mm	210x108x316mm
Weight(excl. accessories)	5.7kg	2.19kg
AC input	110-240V 50/60Hz	110-240V 50/60Hz
DC input	24-36V	24-36V
Max input power	450W	400W

Head Characteristics

Part	2:1C	2:2C	4:1C	4:2C
Dimensions(W x H x D)	533x292x30 mm	533x533x30 mm	1013x292x30 mm	1013x533x30 mm
Weight(excl. accessories)	2.66 kg	3.56 kg	3.78 kg	5.85 kg
Input Voltage	24V	24V	24V	24V
Max power draw	100W	100W	100W	100W

Fault Finding Tips

Issue	Possible Solution
No power seen and rocker switch not lit	Check mains power and fuse.
Two or more fixtures on the same address are behaving differently on dimming or CCT	Check that all fixtures are set to the same personality, output and dimming curve
One or more fixtures on a DMX Universe are flashing or behaving oddly	Confirm that none of the fixtures are in PRIMARY/CLONE or wireless mode

Spare Parts & Accessories

Description	450C	250C	2:1C	2:2C	4:1C	4:2C
Ballast	HIOF0AR	HIORXAR	-	-	-	-
Ballast case	YDOEZA4	YKOWBAQ	-	-	-	-
Power cord	VIKLI7	VIKLI7	-	-	-	-
Aerial	HINXFAR	HINXFAR	-	-	-	-
M6 Eye bolt	JIODAR	JIODAR	-	-	-	-
Kupo mount	HPOEUAK	HPOEUAK	HPOEUAK	HPOEUAK	HPOEUAK	HPOEUAK
4m Extension cable	HIOF1AR	HIOF1AR	HIOF1AR	HIOF1AR	HIOF1AR	HIOF1AR
8m Extension cable	HIOL7AR	HIOL7AR	HIOL7AR	HIOL7AR	HIOL7AR	HIOL7AR
Lamp head	-	-	HIO8VAR	HIO8WAR	HIO8XAR	HIO8YAR
Kit bag	-	-	YOOASAD	YOOARAD	YOOAQAD	YOOAPAD
Spill skirt	-	-	HIOETAR	HIOESAR	HIOERAR	HIOEQAR
Full grid cloth	-	-	JIOAUAR	JIO2MAR	JIO2PAR	JIO2JAR
Half grid cloth	-	-	JIOAVAR	JIO2NAR	JIO2QAR	JIO2KAR
Quarter grid cloth	-	-	JIOAWAR	JIO2OAR	JIO2RAR	JIO2LAR
Magic cloth	-	-	JIOAXAR	JIOATAR	JIOAZAR	JIOAYAR
Snapgrid Eggcrate	-	-	JJODJAJ	JJODIAJ	JJODHAJ	JJODFAJ
Snapgrid bag	-	-	YJODMAJ	YJODLAJ	YJODKAJ	YJODGAJ



06

APPENDIX

ALLEGRA-C Menu Tree

DMX Address	1 – 512	
Personality	1-19	
Colour	WHITE GEL HSI RGB xy	
Source	WIRED WIRELESS PRIMARY CLONE	
Control	CURVES	LINEAR SQUARE LAW S CURVE TUNGSTEN EMULATE
	OUTPUT	BOOST FLAT
	GAMUT	PX VARI WHITE REC 2020 REC 709 DCI P3 ESTA 1.54 PX FULL COLOUR
	CONTROL PRIORITY	LTP EXTERNAL LOCAL
Mode	STANDARD ATTRACT	



Gels

A range of especially created Panalux GELS unique to Allegra and ALLEGRA-C are listed from #850 onwards. Unlike other GELS these colours are not affected by base CCT

Source Matching

Panalux source matching recipes have been measured and formulated from real sources. These formulations are not affected by base CCT. All are pre-fixed with 'SM' for ease of ALPHA sorting and carry numbers 900 onwards

Gel Library

	Gel Name
2	Rose Pink
3	Lavender Tint
4	Medium Bastard Amber
7	Pale Yellow
8	Dark Salmon
9	Pale Amber Gold
10	Medium Yellow
13	Straw Tint
15	Deep Straw
17	Surprise Peach
19	Fire
20	Medium Amber
21	Gold Amber
22	Dark Amber
24	Scarlet
25	Sunset Red
26	Bright Red
27	Medium Red
29	Plasa Red
35	Light Pink
36	Medium Pink
46	Dark Magenta
48	Rose Purple
49	Medium Purple
52	Light Lavender

53	Paler Lavender
58	Lavender
61	Mist Blue
63	Pale Blue
68	Sky Blue
71	Tokyo Blue
75	Evening Blue
79	Just Blue
85	Deeper Blue
88	Lime Green
89	Moss Green
90	Dark Yellow Green
101	Yellow
102	Light Amber
103	Straw
104	Deep Amber
105	Orange
106	Primary Red
107	Light Rose
108	English Rose
109	Light Salmon
110	Middle Rose
111	Dark Pink
113	Magenta
115	Peacock Blue
116	Medium Blue-Green

117	Steel Blue
118	Light Blue
119	Dark Blue
120	Deep Blue
121	Lee Green
122	Fern Green
124	Dark Green
126	Mauve
127	Smokey Pink
128	Bright Pink
131	Marine Blue
132	Medium Blue
134	Golden Amber
135	Deep Golden Amber
136	Pale Lavender
137	Special Lavender
138	Pale Green
139	Primary Green
140	Summer Blue
141	Bright Blue
142	Pale Violet
143	Pale Navy Blue
144	No Colour Blue
147	Apricot
148	Bright Rose
151	Gold Tint

Gel Library (cont.)

152	Pale Gold
153	Pale Salmon
124	Pale Rose
156	Chocolate
157	Pink
158	Deep Orange
159	No Colour Straw
161	Slate Blue
162	Bastard Amber
164	Flame Red
165	Daylight Blue
169	Lilac Tint
170	Deep Lavender
172	Lagoon Blue
174	Dark Steel Blue
176	Loving Amber
179	Chrome Orange
180	Dark Lavender
181	Congo Blue
182	Light Red
183	Moonlight Blue
184	Cosmetic Peach
186	Cosmetic Silver Rose
187	Cosmetic Rouge
188	Cosmetic Highlight
189	Cosmetic Silver Moss

191	Cosmetic Aqua Blue
192	Flesh Pink
194	Surprise Pink
195	Zenith Blue
196	True Blue
197	Alice Blue
198	Palace Blue
199	Regal Blue
212	L.C.T.Yellow
213	White Flame Green
219	Fluorescent Green
230	Super Corr.L.C.T.Yellow
232	S.Cor WF.Grn to Tungsten
236	H.M.I. (to Tungsten)
237	C.I.D. (to Tungsten)
238	C.S.I. (to Tungsten)
241	Lee Fluorescent 5700K
242	Lee Fluorescent 4300K
243	Lee Fluorescent 3600K
322	Soft Green
323	Jade
327	Forest Green
328	Follies Pink
332	Special Rose Pink
343	Special Medium Lavender

345	Fuchsia Pink
352	Glacier Blue
353	Lighter Blue
354	Special Steel Blue
361	Surprise Blue (BBC)
363	Special Medium Blue
366	Cornflower
441	Full C.T. Straw
442	Half C.T. Straw
443	Quarter C.T. Straw
444	Eighth C.T. Straw
500	Double New Colour Blue
501	New Col Robertson Blue
502	Half New Colour Blue
503	Quarter New Colour Blue
504	Waterfront Green
505	Sally Green
506	Marlene
507	Madge
508	Midnight Maya
511	Bacon Brown
512	Amber Delight
513	Ice And A Slice
514	Double G and T
525	Argent Blue
550	ALD Gold

Gel Library (cont.)

604	Full C.T. Eight Five
642	1/2 Mustard Yellow
643	1/4 Mustard Yellow
650	Industry Sodium
651	Hi Sodium
652	Urban Sodium
700	Perfect Lavender
701	Provence
702	Special Pale Lavender
703	Cold Lavender
704	Lily
705	Lily Frost
706	King Fals Lavender
707	Ultimate Violet
708	Cool Lavender
709	Electric Lilac
710	Spir Special Blue
711	Cold Blue
712	Bedford Blue
713	J. Winter Blue
714	Elysian Blue
715	Cabana Blue
716	Mikkel Blue
719	Colour Wash Blue
721	Berry Blue
722	Bray Blue

723	Virgin Blue
724	Ocean Blue
725	Old Steel Blue
727	QFD Blue
728	Steel Green
729	Scuba Blue
730	Liberty Green
731	Dirty Ice
733	Damp Squib
735	Velvet Green
736	Twickenham Green
738	JAS Green
740	Aurora Borealis Green
741	Mustard Yellow
742	Bram Brown
744	Dirty White
746	Brown
747	Easy White
748	Seedy Pink
763	Wheat
764	Sun Colour Straw
765	Lee Yellow
767	Oklahoma Yellow
768	Egg Yolk Yellow
770	Burnt Yellow
773	Cardbox Amber

774	Soft Amber Key 1
775	Soft Amber Key 2
776	Nectarine
777	Rust
778	Millennium Gold
779	Bastard Pink
780	AS Golden Amber
781	Terry Red
787	Marius Red
789	Blood Red
790	Moroccan Pink
791	Moroccan Frost
793	Vanity Fair
795	Magical Magenta
797	Deep Purple
798	Chrysalis Pink
799	Special K H Lav
801	Zircon Minus Green 1
802	Zircon Minus Green 2
803	Zircon Minus Green 3
804	Zircon Minus Green 4
805	Zircon Minus Green 5
806	Zircon Warm Amber 2
807	Zircon Warm Amber 4
808	Zircon Warm Amber 6
809	Zircon Warm Amber 8



Gel Library (cont.)

810	Zircon Diffusion 1
811	Zircon Diffusion 2
812	Zircon Diffusion 3
813	Zircon Warm Amber 5 (O32)
814	Zircon Warm Amber 9 (R31)
815	Zircon Dark Density
816	Zircon Mid Density
817	Zircon Pale Density

818	Zircon Cool Blue 6
819	Zircon Cool Blue 8
820	Zircon Cool Blue 10
840	Special Cyan 15
841	Special Cyan 30
842	Special Cyan 60
850	Panalux Inky Blue
851	Panalux Full Amber
852	Panalux Phosphor Green

855	Panalux Midnight Layla
856	Panalux Backlight Blue
857	Panalux Deep Congo Blue
858	Panalux Neon Pink
859	Panalux Salty Dog Sea
860	Panalux Lush Lavender
861	Panalux Deepest violet



Source Emulation List

900	Candle flame 1700K	920	Flourescent warm white
901	Candle flame 1850K	921	Flourescent neutral white
902	High Quality Filament LED	922	Flourescent cold white
903		923	Flourescent old green
904	Carbon arc	924	Halophosphate florescent
905	Low pressure sodium	925	Auto Xenon headlamp
906	Sodium vapour	926	Auto sealed beam headlamp
907	High Press stadium light	927	Auto Indicator (modern)
908	Mercury vapour	928	Auto Indicator (classic)
909	Xenon	929	Auto side light (classic)
910	Arena lighting	930	
911	Frosty night	931	
912	Val d'isere	932	
913	Watery winter sunlight	933	
914	Shadow side winter sun	934	
915	Overcast winter dusk	935	Green screen (narrow band)
916		936	Blue screen (narrow band)
917	Sunlight - 5790K - clear blue sky - midsummer	937	Green screen (power)
918	Electronic flash	938	Blue screen (power)
919			



RDM

The ALLEGRA-C™ is RDM Enabled

RDM functionality gives the ability to remotely identify the fixture, set its DMX address and DMX personality, and other options. This feature also enables information about ALLEGRA-C to be read remotely, such as the temperature of the LED arrays. See the full list of RDM functions and monitoring options below:

	Function	Type
1	UID (Unique Identifier) to allow recognition of individual fixtures	Monitoring
2	RDM Protocol Version	Monitoring
3	Device Model Description	Fixed
4	Manufacturer Label	Fixed
5	Software Version	Fixed
6	Serial Number	Fixed
7	DMX Footprint	Monitoring
8	DMX Personality Description	Monitoring
9	DMX Start Address	User Editable
10	DMX Personality	User Editable
11	Dimming Curve	User Editable
12	Output Mode	User Editable
13	Colour Gamut	User Editable
14	Camera LUT	User Editable
15	Device Hours	Monitoring
16	Lamp Hours	Monitoring
17	Power Output	Monitoring
18	Reset device to factory defaults and wipe saved scenes	User Editable



ALLEGRA-CTM 2:1 Overall Dimensions & Rigging Centres

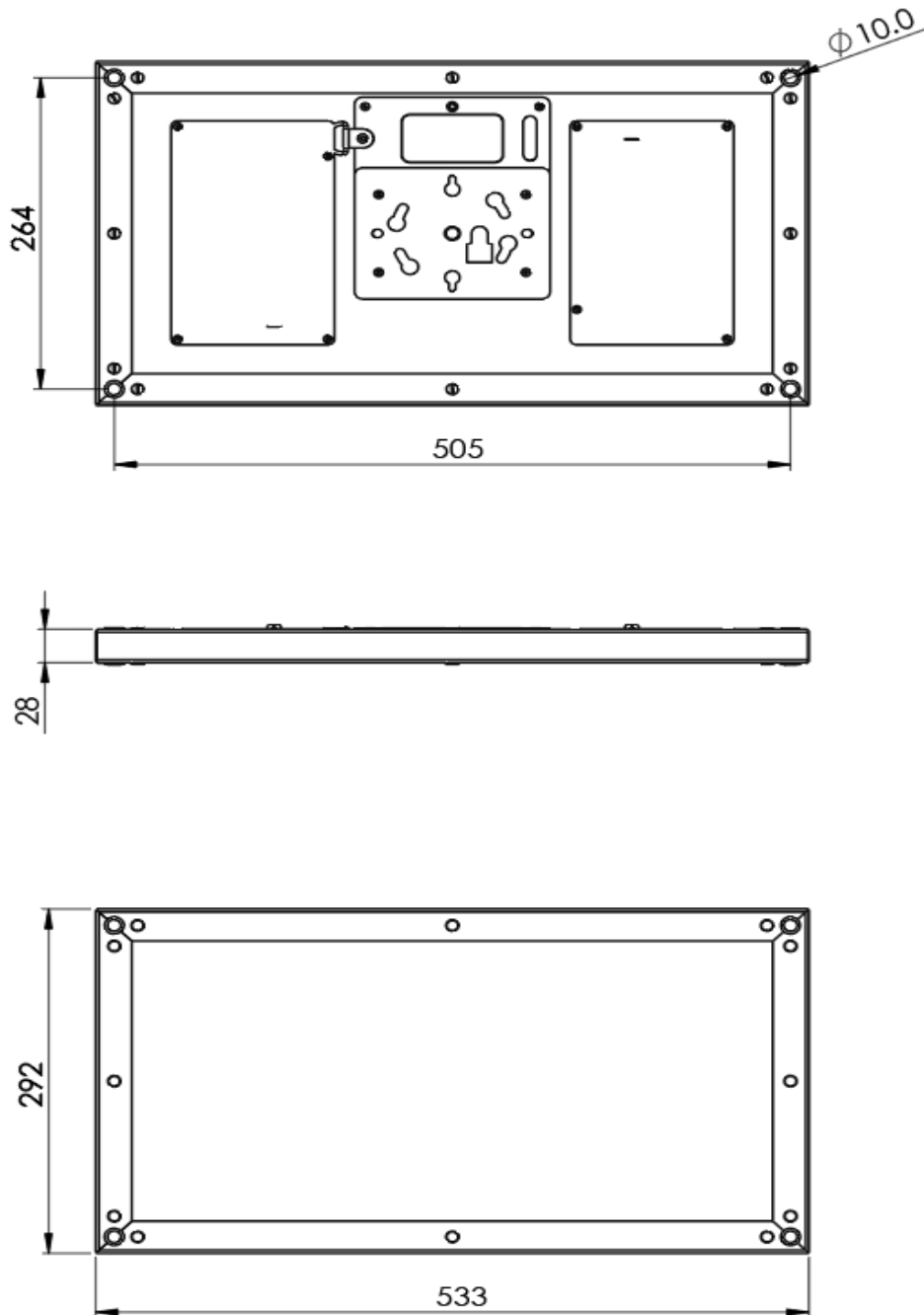

ALLEGRA-CTM 2:2 Overall Dimensions & Rigging Centres

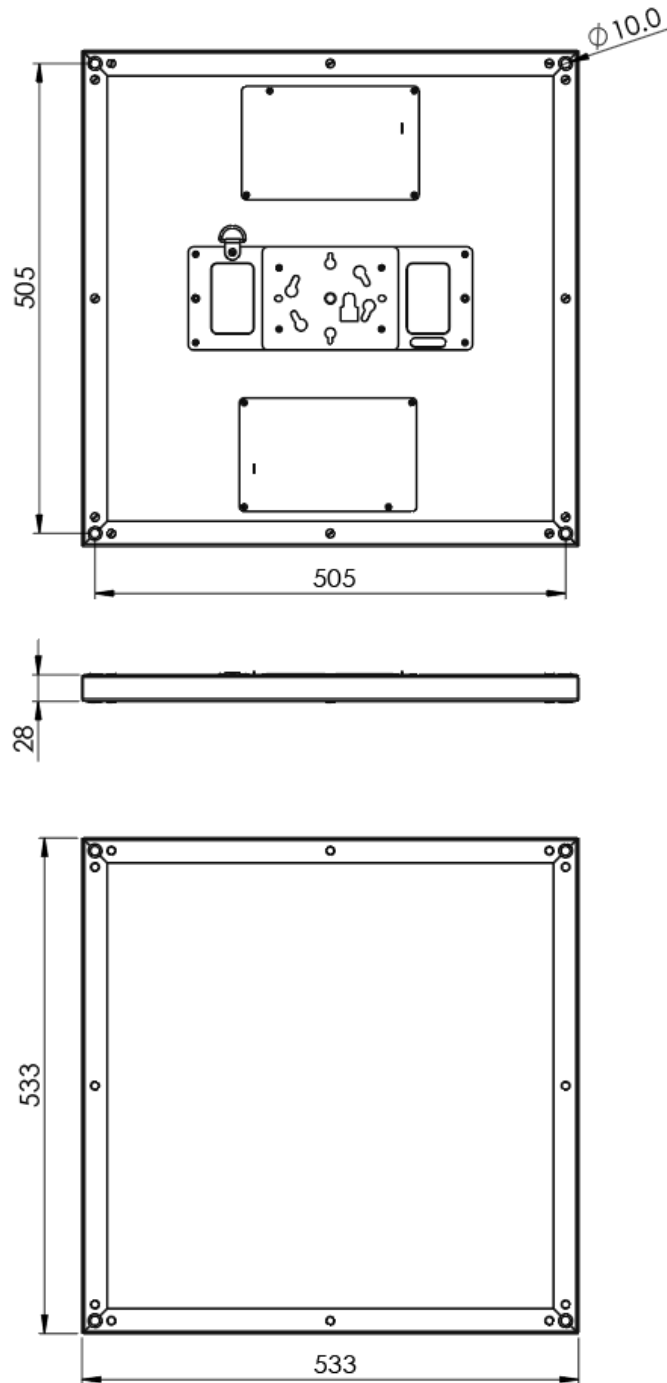

ALLEGRA-CTM 4:1 Overall Dimensions & Rigging Centres

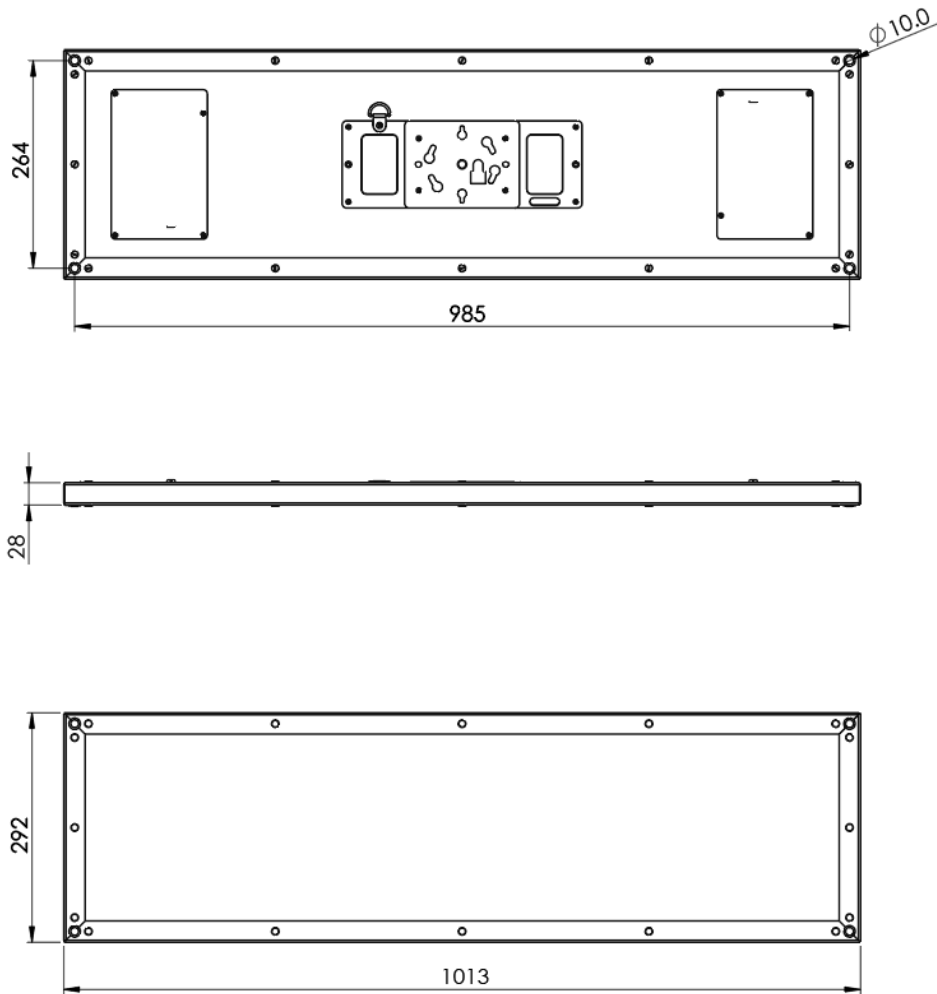

ALLEGRA-CTM 4:2 Overall Dimensions & Rigging Centres

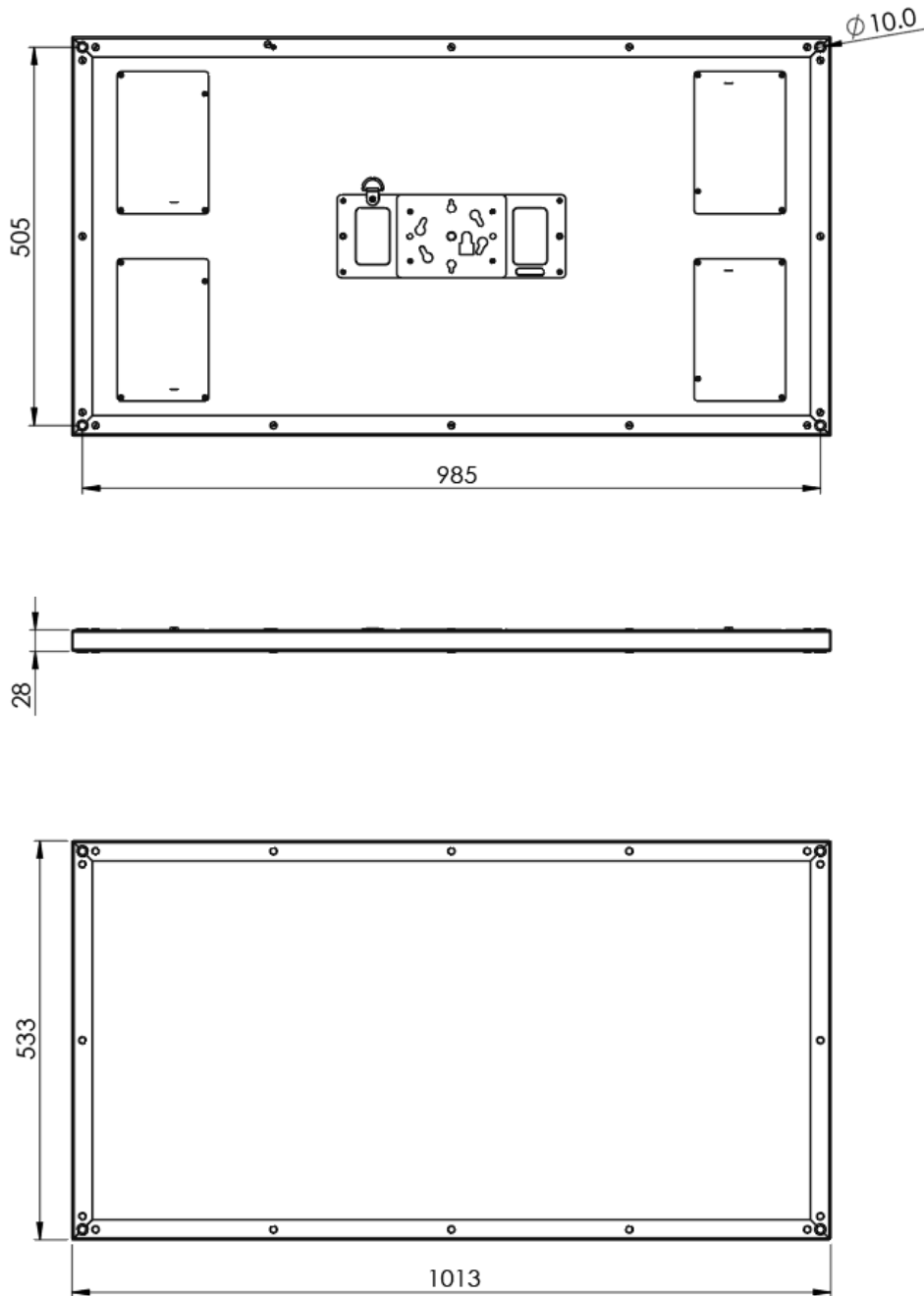

ALLEGRA-C 450C LED Driver - Overall Dimensions & Rigging Centres

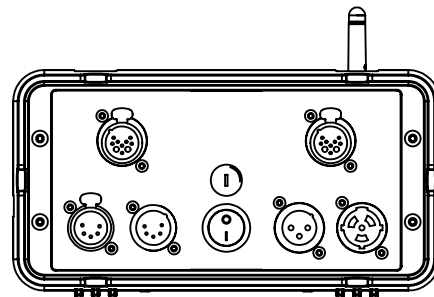
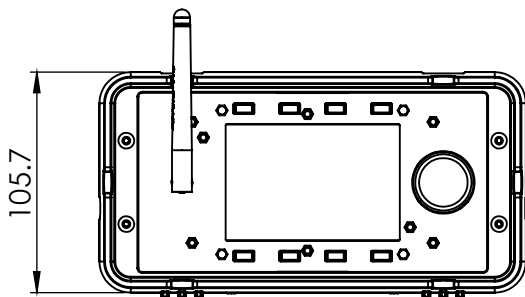
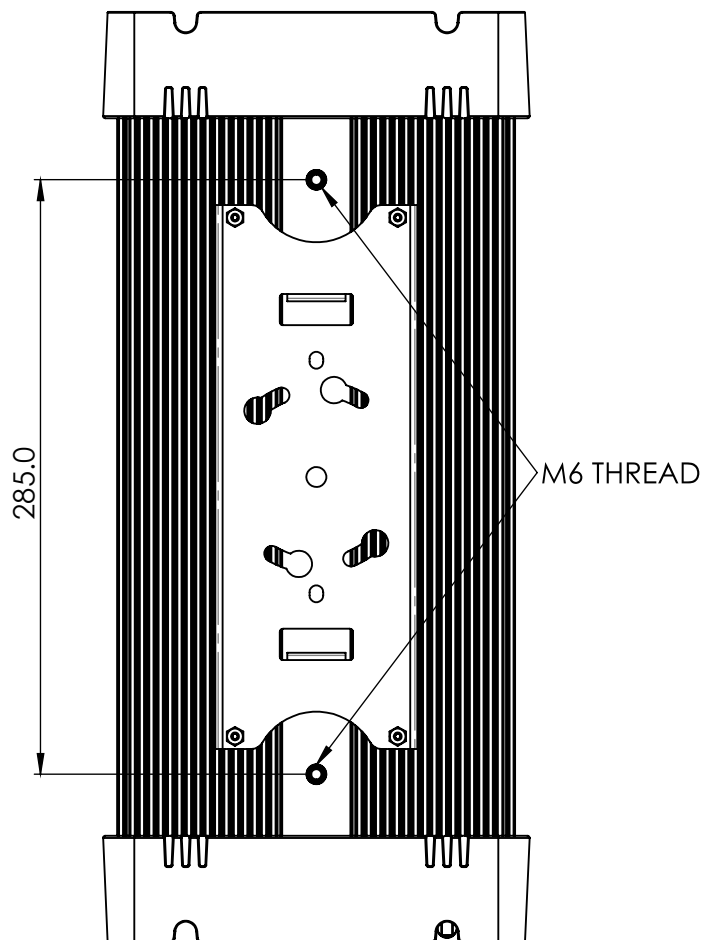
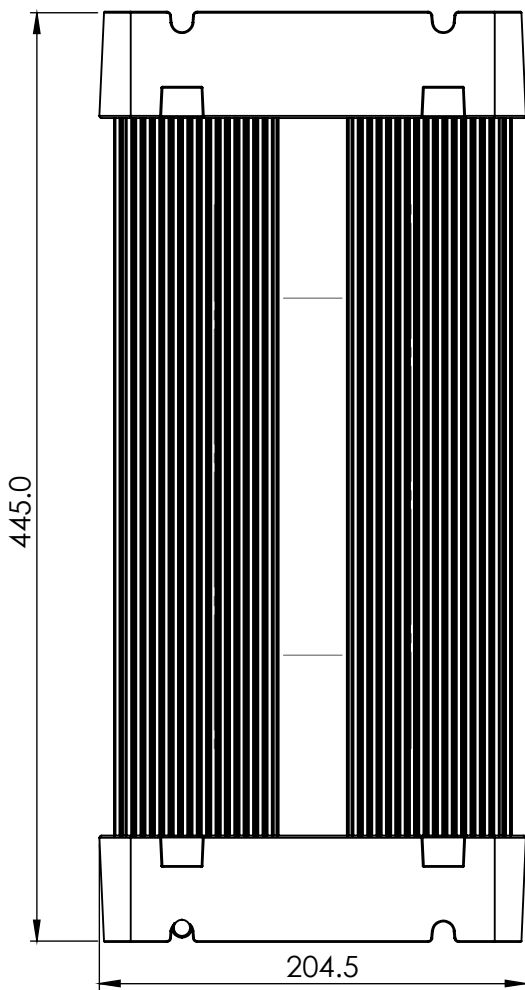

ALLEGRA-C 250C LED Driver - Overall Dimensions & Rigging Centres

