

QUAD HEAD SECURITY LIGHT

Model Number: E1211-WH
E1211-BZ



Questions, problems, missing parts?

Before returning to your retailer, call our customer service at 1-800-887-6326
Monday – Friday 9:00 a.m. – 5:00 p.m. CST

PACKAGE CONTENTS

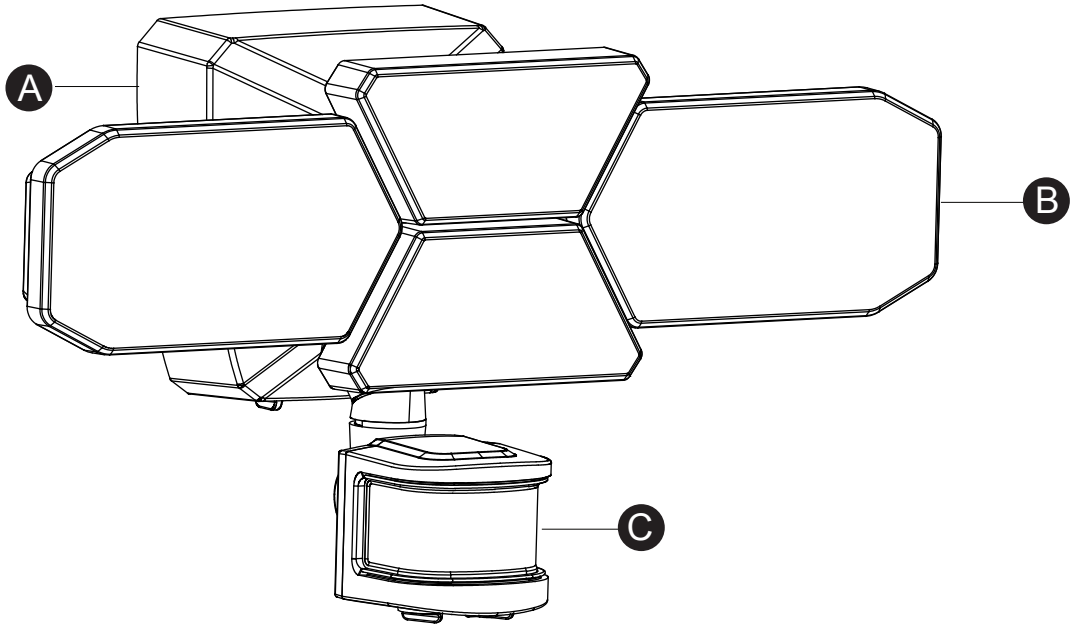

HARDWARE CONTENTS Note: Hardware not shown actual size.

AA

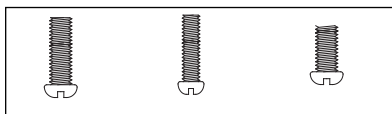

Mounting Screw
X2

BB

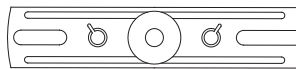

Mounting Strap
X1

CC



Wire Connector
X2

DD



Decorative cover
X1

EE

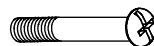

Fixture Mounting Screw
X1

FF

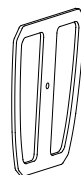

Gasket
X1

⚠ SAFETY INFORMATION

Please read and understand this entire manual before attempting to assemble, operate or install the product.

WARNING

- Turn off electricity at main fuse box (or circuit breaker box) before beginning installation by removing fuse (or switching off circuit breaker).
- Be careful not to damage or cut the wire insulation (covering) during fixture installation. Do not permit wires to contact any surface having a sharp edge. To do so may damage or cut the wire insulation, which could cause serious injury or death from electric shock.

CAUTION

- All electrical connections must be in agreement with local codes, ordinances or the national electric code (NEC). Contact your municipal building department to learn about your local codes, permits and/or inspections.
- Risk of fire – most dwellings built before 1985 have supply wire rated for 140°F/60°C. Consult a qualified electrician before installation.
- Only general ON/OFF wall switch applies for this fixture. A dimmable wall switch shouldn't be used.

Rated Wattage: 39 W

Working Temperature Range: -13°F ~ 113°F

PREPARATION

Before beginning assembly, installation or operation of product, make sure all parts are present. Compare parts with package contents list and diagram on previous page. If any part is missing or damaged, do not attempt to assemble, install or operate the product. Contact customer service for replacement parts.

Tools Required for Assembly (not included): Slotted Screwdriver, Phillips Screwdriver, Pliers, Electrical Tape, Wire Cutters, Safety Glasses, Ladder, Wire Stripper, Silicone Caulking Compound.

ASSEMBLY INSTRUCTIONS

Important to Know

1. This fixture requires a 120 VAC, 60 Hz power source.
2. For general safety and to avoid any possible damage to the sensor, be sure the power is switched "off" before adjustment.
3. Motion sensor: turns light ON automatically when motion is detected and turns light down to lower level or OFF automatically when motion stops.
4. Photocell keeps the light OFF during daylight hours.

Note: Fixture can be wall mounted or eave mounted.

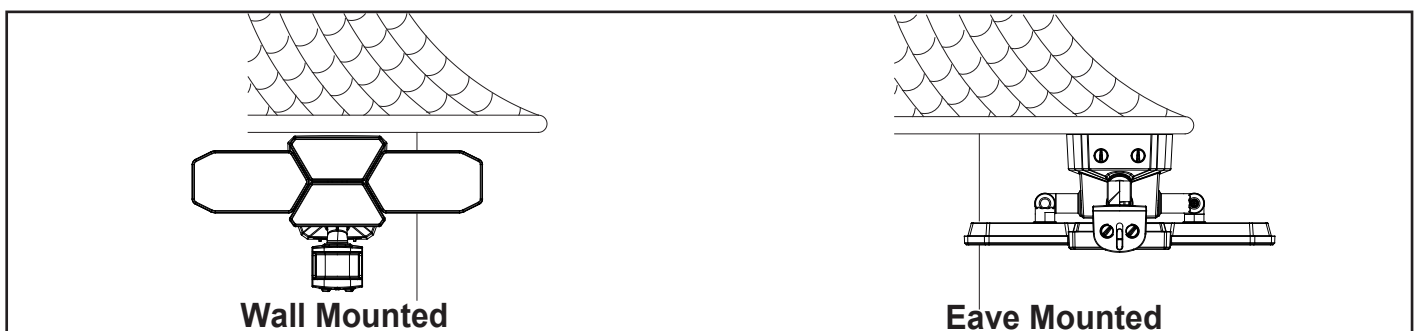

Light fixture and sensor should be mounted as shown above when installed (depending upon type of installation). Before installing the light fixture under an eave, the sensor head must be rotated as shown in the next two steps for proper operation and to avoid the risk of electrical shock.

ASSEMBLY INSTRUCTIONS (continued)

For eave mounted only:

⦿ Swing the sensor head towards the mounting surface.

⦿ Rotate the sensor head clockwise 180° so the controls face down.

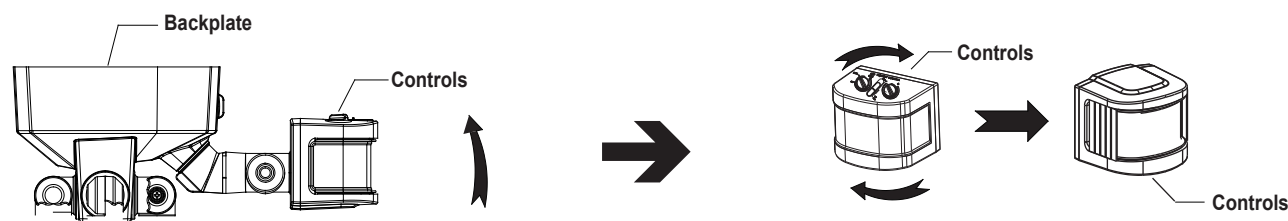

Installation Steps

Turn off the power at fuse or circuit box.

1. Install the mounting strap (BB) to the outlet box with the stamped word "FRONT" facing away from the outlet box, using two mounting screws (AA) that best fit the outlet box. (Choose one matching pair of suitable mounting screws from the 3 pairs provided)

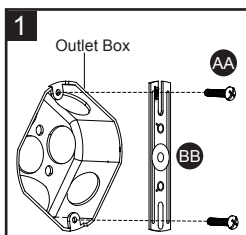

2. Thread the fixture wires through gasket (FF), and then attach the gasket (FF) on the backplate of the light fixture (A).

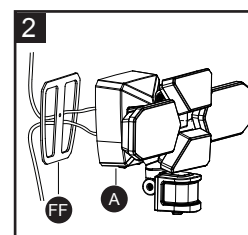

3. Connect the fixture black wire to the house black wire and the fixture white wire to the house white wire using wire connectors (CC) provided. Carefully tuck the wires back into the outlet box.

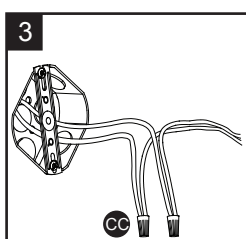

4. Attach the backplate of the light fixture (A) to the mounting strap (BB), by securing it with the fixture mounting screw (EE). Push the decorative cover (DD) firmly into the fixture mounting screw hole on the light fixture (A).

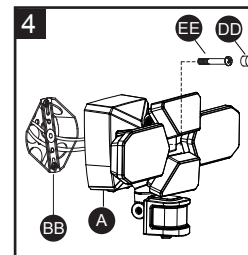

5. Using a silicone caulking compound (not included), caulk completely around where the backplate of the light fixture (A) meets the wall surface.

CAUTION: Be sure to caulk completely where the backplate meets the wall surface to prevent water from seeping into the light fixture (A) and outlet box.

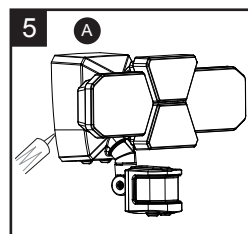

Adjusting the Sensor Head:

1. a: Aim sensor head (C) toward desired detection area, maintaining a 5° - 40° downward angle to allow moisture to drain.
Note: Make sure sensor head is positioned with control knob facing towards the ground.
b: You can rotate the sensor head up and down to change the coverage area. (See Fig.1)

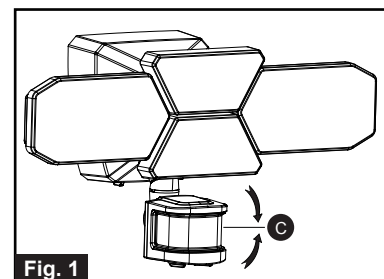

2. Note: Range set too high may increase false triggering. (See Fig.2, Fig.3)

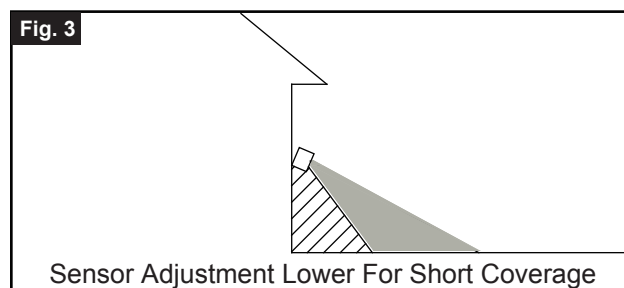
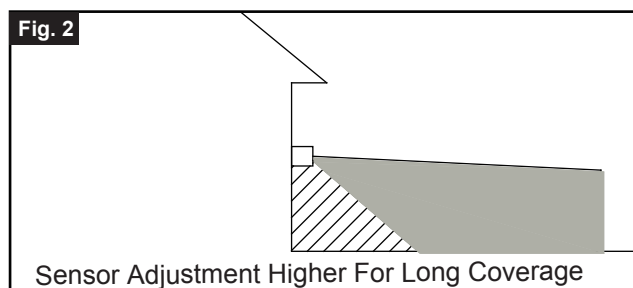

Adjusting the Light Head:

1. Adjust the left or right Light Head

Gently grasp the left or right light heads (B) and bend them towards the mounting surface away from the center light heads before rotating up or down to desired angle (See Fig.4).

2. Adjust the center top and bottom Light Head

Gently grasp the center top light head and turn it upwards to desired angle.

Gently grasp the center bottom light head and turn it downwards to desired angle (Avoid light surface shine directly towards the motion sensor for better sensing effect).

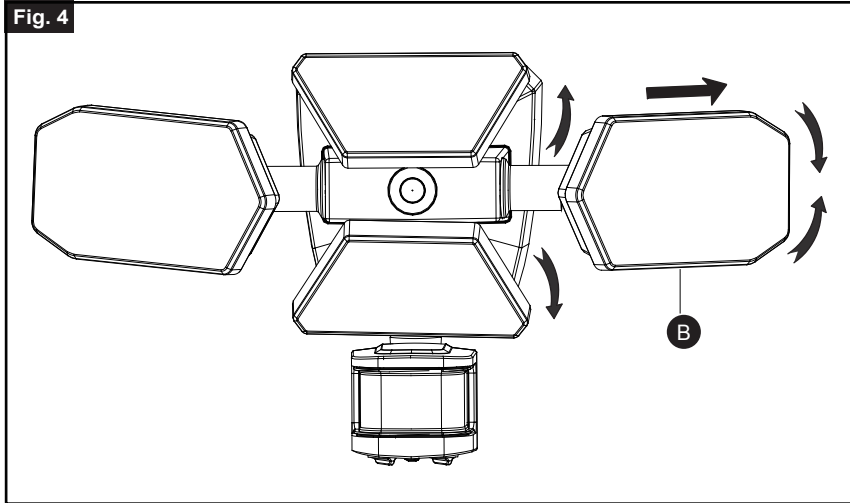

FUNCTION AND OPERATION

Sensitivity of Motion Sensor

- You can adjust the sensitivity of the motion sensor by using the “SENS” selector located on the right side of the sensor head. (See Fig.5)
- Adjust motion sensor sensitivity to HIGH (H), MEDIUM (M), or LOW (L) to achieve desired performance.
- Approximate range for each setting: 70 ft. (H), 50 ft. (M), 30 ft. (L).

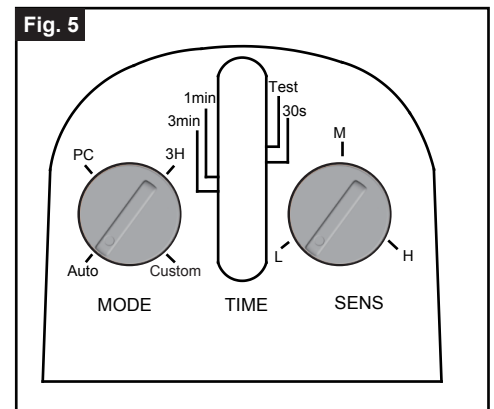

FUNCTION AND OPERATION (continued)

Choose a mode by rotating the switch on the bottom of the sensor of the fixture. (See Fig.5)

Note: When power is first applied, the light will be on and warm up lasts 30 seconds.

1. TEST MODE (daytime and nighttime operation.)

- Slide the Time switch to "Test" position.
- The light turns to high-level brightness (5000K) when motion is detected, and stays on as long as the motion continues. Then it reverts back to low-level brightness (0~50%) and CCT (Correlated Color Temperature) color (2200K~5000K) as per setting about 5 seconds after motion is no longer detected.

2. AUTO MODE (nighttime operation only)

- In "AUTO" mode, slide the Time switch to the desired time setting (30s/1min/3min). At dusk, the light turns on to pre-selected low-level brightness and CCT color. When motion is detected, the light turns to full brightness (5000K) and stays on as long as motion continues. When the motion is no longer detected, the light at full brightness (5000K), remains on for predetermined time you set (30s/1min/3min), and then switches back to the pre-selected low-level brightness and CCT color automatically.
- The light turns off automatically at dawn.

Note: You can adjust the low-level brightness (0~50%) and CCT color (2200K~5000K) by using the low-level brightness (0~50%) knob and CCT color (2200K~5000K) knob on the backplate (See Fig.6)

3. PC MODE (nighttime operation only)

- In "PC" mode, the light turns on at full brightness at dusk and remains on until dawn.

Note: You can adjust the CCT color (2200K~5000K) by using the CCT color (2200K ~5000K) knob on the backplate. (See Fig.6)

4. 3 HOURS (3H) MODE (nighttime operation only)

- In "3H" mode, the light turns to high-level brightness (100%) and pre-selected CCT (2200K~5000K) at dusk, and stays "ON" for 3 hours, then after 3 hours it turns to Auto Mode. It then turns to high-level brightness (100%) when motion is detected, and stays on as long as motion continues. When motion is no longer detected, it remains on for the predetermined shut-off delay time you set (30s/1min/3min), then returns to the predetermined low level brightness and CCT color automatically.
- The light turns off automatically at dawn.

Note: You can adjust the low-level brightness (0~50%) and CCT color (2200K~5000K) by using the low-level brightness (0~50%) knob and CCT color (2200K~5000K) knob on the backplate (See Fig.6)

5. CUSTOM MODE (nighttime operation only):

- In "CUSTOM" mode, the light turns on at dusk and off at dawn automatically.

Note: You can adjust the CCT color (2200K~5000K) by using the CCT color (2200K~5000K) knob on the backplate (See Fig.6)

- Set motion sensor operation to go on at a specific time. Turn the wall switch "OFF", and turn it "ON" twice within 3 seconds. The light will go into motion-sensor operation at the specified time every night. The light turns off automatically at dawn.

For example, a homeowner wants to have the light stay on high-level brightness from dusk to 8pm, and would like the light to go into "AUTO motion sensor mode. To achieve this, the homeowner will turn the wall switch "OFF", and turn it "ON" twice within 3 seconds. This sets the time the light goes into "AUTO" mode every day, the light will behave the same way.

To revert back to Default, turn the wall switch "OFF" and then turn it "ON" after 5 seconds.

Note: You can adjust the low-level brightness (0~50%) and CCT color (2200K~5000K) by using the low-level brightness (0~50%) knob and CCT color (2200K~5000K) knob on the backplate (See Fig.6)

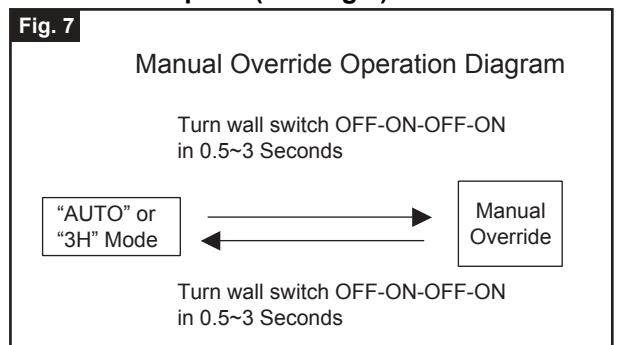
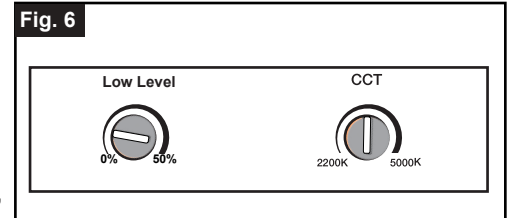

FUNCTION AND OPERATION (continued)

6. Manual Override (nighttime operation only)

- To temporarily override the settings in "AUTO" or "3H" mode for on-demand continuous high-level brightness at night, turn the wall switch "OFF" then turn it "ON" twice within 3 seconds, the light remains on all night long. To shift back to "AUTO" or "3H" mode, turn the wall switch "OFF" then turn it "ON" twice within 3 seconds again. (See Fig.7)
- The light turns off automatically at dawn.

7. CCT Color Switching

- CCT Color adjustable function applies to low-level brightness in Auto mode when no motion is detected, and during the start of 3H, PC, and Custom mode.

Note: To make sure the above functions operate properly, always keep the wall switch in the "ON" position (including the daytime).

Customization Options:

Shut-off Delay

- The shut-off delay is the length of time the light will stay at brightness after motion is detected.
- You can set the shut-off delay by sliding the Time switch so that points to the desired time setting (30s/1min/3min).

Notes:

1. The sensitivity of the motion sensor will increase as the environmental temperature gets cooler. For best performance, gently clean the lens with a soft cloth every 1 or 2 months to ensure maximum sensitivity.
2. For best performance, install fixture at least 8 feet above the ground. At such a height, the fixture will provide a detection distance of up to 70 feet at 77 degrees Fahrenheit. (See Fig.8)
3. The sensor detects movement across a detection range of 240 degrees. (See Fig.9)
4. The sensor will be more sensitive to motion across its detection path than motion directly towards it. (See Fig.10)
5. To reduce possible nuisances, do not mount the fixture near a heat source like an air conditioner, vent or furnace exhaust, or in a direction facing any reflective object or other nearby light source.

Where you install your fixture is important:

Be sure the light is mounted straight on the wall or eave; otherwise, the detection distance may be limited.

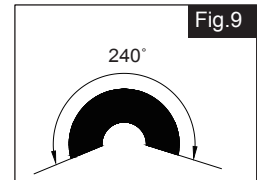
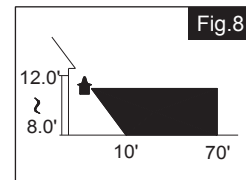
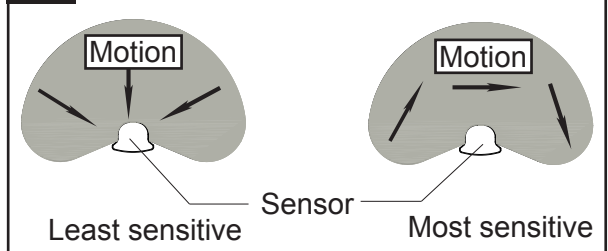
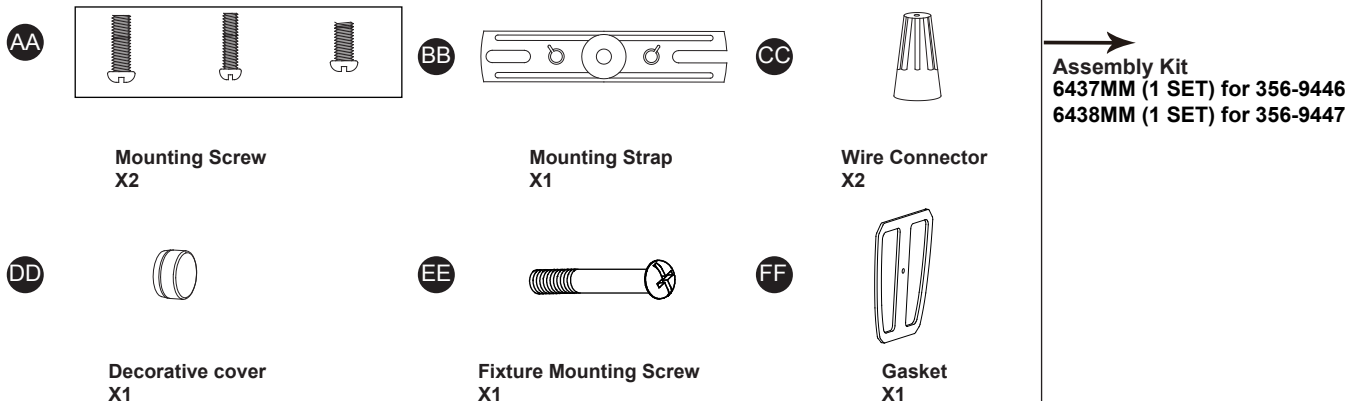

Fig. 10



The following parts are available for reorder if damaged or missing. Call our toll free at 1-800-887-6326.

Spare Parts List:



TROUBLESHOOTING

Problem	Possible Cause	Solution
The light will not come on.	<ul style="list-style-type: none"> <input type="checkbox"/> The light switch is turned off. <input type="checkbox"/> The fuse is blown or the circuit breaker is turned off. <input type="checkbox"/> Daylight turn-off (photocell) is in effect. <input type="checkbox"/> The circuit wiring is incorrect (if this is a new installation). <input type="checkbox"/> The motion sensor is aimed in the wrong direction. <input type="checkbox"/> The outside air temperature is close to the same as a person's body heat. 	<ul style="list-style-type: none"> <input type="checkbox"/> Turn the light switch on. <input type="checkbox"/> Replace the fuse or turn the circuit breaker on. <input type="checkbox"/> Recheck after dark. <input type="checkbox"/> Verify the wiring is correct. <input type="checkbox"/> Re-aim the motion sensor to cover the desired area. <input type="checkbox"/> Increase the "SENS" setting.
The light comes on during the day.	<ul style="list-style-type: none"> <input type="checkbox"/> The motion sensor may be installed in a relatively dark location. <input type="checkbox"/> The "TIME" switch is in the "TEST" position. 	<ul style="list-style-type: none"> <input type="checkbox"/> The light fixture is operating normally under these circumstances <input type="checkbox"/> Set the "TIME" switch to the 30s, 1min or 3min setting.
The light comes on for no apparent reason.	<ul style="list-style-type: none"> <input type="checkbox"/> The motion sensor may be sensing small animals or automobile traffic. <input type="checkbox"/> The "SENS" switch is set too high. <input type="checkbox"/> The outside temperature is much warmer or cooler than a person's body heat (summer or winter). <input type="checkbox"/> The light fixture is wired through a dimmer or timer. 	<ul style="list-style-type: none"> <input type="checkbox"/> Decrease the "SENS" setting or reposition the motion sensor. <input type="checkbox"/> Decrease the "SENS" setting. <input type="checkbox"/> Decrease the "SENS" setting. <input type="checkbox"/> Do not use a dimmer or timer to control the light fixture. Replace the dimmer or timer with a standard on/off wall switch.
The lights turn off too late in the PC setting.	<ul style="list-style-type: none"> <input type="checkbox"/> The light fixture may be installed in a relatively dark location. 	<ul style="list-style-type: none"> <input type="checkbox"/> Relocate the light fixture or use the 3 hour setting.
The lights stay on continuously.	<ul style="list-style-type: none"> <input type="checkbox"/> The motion sensor may be picking up a heat source, such as an air vent, dryer vent, or brightly painted, heat-reflective surface. <input type="checkbox"/> The motion sensor is in manual mode. <input type="checkbox"/> The light fixture is wired through a dimmer or timer. <input type="checkbox"/> The light fixture is on the same circuit as a motor, transformer, or fluorescent bulb. 	<ul style="list-style-type: none"> <input type="checkbox"/> Decrease the "SENS" setting or reposition the motion sensor. <input type="checkbox"/> Switch the motion sensor to auto. See page 2 Fig.5. <input type="checkbox"/> Do not use a dimmer or timer to control the light fixture. Replace the dimmer or timer with a standard on/off wall switch. <input type="checkbox"/> Install the light fixture on a circuit without motors, transformers, or fluorescent bulbs.

TROUBLESHOOTING (CONTINUED)

Problem	Possible Cause	Solution
The lights flash on and off.	<input type="checkbox"/> Heat or light from the lamp heads may be turning the motion sensor on and off. <input type="checkbox"/> Heat is being reflected from other objects and may be turning the motion sensor on and off. <input type="checkbox"/> The motion sensor is in "TEST" mode and warming up.	<input type="checkbox"/> Reposition the lamp heads away from the motion sensor. <input type="checkbox"/> Decrease the "SENS" setting or reposition the motion sensor. <input type="checkbox"/> While in "TEST" mode, the light only stays on for 30 seconds. Set the "TIME" switch to 30s, 1min, or 3min.
The lights flash once then stay off in manual mode.	<input type="checkbox"/> The motion sensor is detecting light from the lamp heads.	<input type="checkbox"/> Reposition the lamp heads to keep the area below the motion sensor relatively dark.

If unable to fix any of the above issues, please consult a certified electrician.

FIVE-YEAR LIMITED WARRANTY: If, during normal use, this PATRIOT LIGHTING® lighting fixture breaks or fails due to a defect in material workmanship within five (5) years from the date of original purchase, simply bring this lighting fixture with the original sales receipt back to your nearest MENARDS® retail store. At its discretion, PATRIOT LIGHTING® agrees to have the product or any defective part(s) repaired or replaced with the same or similar PATRIOT LIGHTING® product or part free of charge, within the stated warranty period, when returned by the original purchaser with original sales receipt. This warranty; (1) excludes expendable parts including but not limited to light bulbs; (2) does not cover damage that has resulted from abuse or misuse; and (3) does not cover any losses, labor, injuries to persons/property or costs. This warranty does give you specific legal rights and you may have other rights, which vary from state to state.



Questions, problems, missing parts?

Before returning to your retailer, call our customer service at 1-800-887-6326
Monday – Friday 9:00 a.m. – 5:00 p.m. CST