

English only (Australia, New Zealand, UK, Hong Kong, and Ireland)

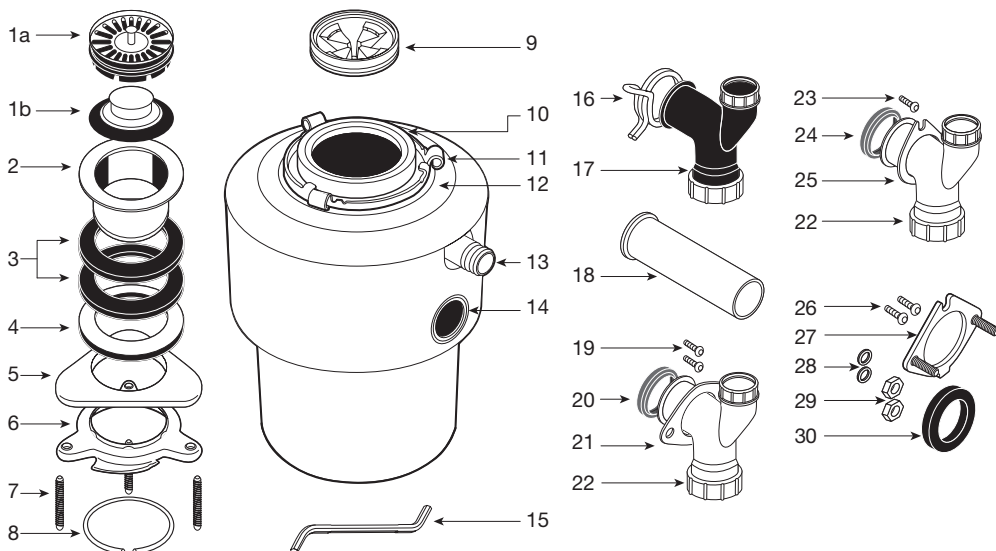

Part No. 75978 REV. A

www.insinkerator.com

©2009 InSinkErator, a division of Emerson Electric Co. All Rights Reserved.

**230-240V, 50Hz**  
**for Australia and New Zealand**  
**220-240V, 50Hz**  
**for UK/Hong Kong/Ireland**

## FOOD WASTE DISPOSER INSTALLATION, CARE & USE MANUAL

Food waste disposers provide an environmentally responsible alternative to transporting food waste to landfills. And they can help reduce greenhouse gas emissions. At capable wastewater treatment plants, food waste can be converted to biosolids and used as fertilizer. Capable plants can also capture methane gas and recycle it as an energy source. (Check the plant in your area.)

Read through the entire Installation, Care & Use manual before installing the disposer. Determine which of the tools, materials, and accessories you will need before you begin. Make sure you have all necessary disposer parts before installing the disposer.

**NOTE:** The Evolution models grind much finer than any other disposer. For this reason you may notice that it takes a little longer to grind some food waste. Due to the Evolution 200 model's microprocessor, users will experience a fractional second delay when starting on all Evolution 200 models. This is completely normal.

**NOTE:** In Australia, all plumbing and electrical work **must** be completed by a qualified tradesperson. This product may require approval of the relevant regulator and/or the sewerage system operator. Disposer must be installed to AS/NZS 3500.2 standard requirements.

**NOTE:** Make sure that the installation of this appliance is allowed by the authorities.

### TOOLS & MATERIALS YOU WILL NEED:

Slotted Screwdriver, Adjustable Pliers, Safety Glasses

### TOOLS, MATERIALS, AND ACCESSORIES YOU MAY NEED:

Phillips Screwdriver, Drain Auger, 9.5 mm Electrical Clamp, Wire Nuts (2), 38 mm Drain Trap, 33 mm Hole Drill, Hammer, Hacksaw, Water Hose Clamp, Pipe Wrench, Copper Earth Wire, Dishwasher Drain Connection Kit, Electrical On/Off Switch, Drain Tube Extension

## PARTS LIST (May vary depending on model)

### MOUNTING ASSEMBLY

- 1a. Strainer Basket and Plug (Evolution models)
- 1b. Stopper (Models 65, 55, 45, LC-50)
2. Sink Flange
3. Rubber Gaskets (2)
4. Fiber Gasket (optional)
5. Backup Ring
6. Mounting Ring
7. Screws (3)
8. Snap Ring

### DISPOSER

9. Sound Baffle (Evolution models, Model 65)
10. Mounting Gasket/Splash Baffle
11. Lugs
12. Lower Mounting Ring
13. Dishwasher Inlet
14. Discharge Outlet
15. Wrenchette

### DISCHARGE ASSEMBLY #1

- (Evolution models)
16. Hose Clamp
  17. Black Elbow Discharge Tube (38 mm diameter/Evolution flange)
  18. Straight Discharge Tube 40.3 mm OD (Australia installation only)

### DISCHARGE ASSEMBLY #2

- (Models 65, 55, 45)
19. Bolts (2) 13 mm 1/4-20 UNC
  20. Rubber Gasket
  21. Metal Flange
  22. White Elbow Discharge Tube (38 mm diameter/non-Evolution flange)

### DISCHARGE ASSEMBLY #3

- (LC-50 for household installation)
23. Bolt (1) 19 mm 1/4-20 UNC
  24. Rubber Gasket
  25. Metal Flange
  22. White Elbow Discharge Tube (38 mm diameter/non-Evolution flange)

### DISCHARGE ASSEMBLY #4

- (Australia Model LC-50 connected to Caroma Connector not supplied)
26. Bolt (1) 19 mm 1/4-20 UNC
  27. Metal Flange (Use to connect to proper Caroma Connector)
  28. Metal Washers (2)
  29. Nuts (2)
  30. Rubber Gasket

### DISCHARGE ASSEMBLY #5

- (Australia Models 65, 55, 45; connected to Caroma Connector not supplied)
26. Bolts (2) 19 mm 1/4-20 UNC
  28. Metal Washers (2)
  30. Rubber Gasket

### ⚠ DANGER

Danger indicates an imminently hazardous situation which, if not avoided, will result in death or serious injury.



### ⚠ NG

Warning indicates a potentially hazardous situation which, if not avoided, could result in death or serious injury.

### ⚠ JN

Caution indicated a potentially hazardous situation, which, if not avoided, may result in minor or moderate injury.

1

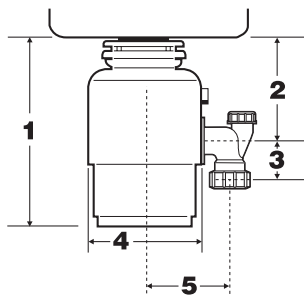

	1	2	3	4	5
<b>(Evolution) 200-1, -3</b>	34.4 cm	18.5 cm	6.4 cm	23.4 cm	16.8 cm
<b>(Evolution) 100-1, -3</b>	31.2 cm	17.1 cm	6.4 cm	20.5 cm	16.8 cm
<b>Model 65-1B, -3B</b>	31.8 cm	16.8 cm	6.4 cm	18.5 cm	13.1 cm
<b>Model 55-1B, -1B A/S, -3B, -3B A/S</b>	31.8 cm	16.8 cm	6.4 cm	17.3 cm	13.1 cm
<b>Model 45-1B, -1B A/S, -3B</b>	31.8 cm	16.8 cm	6.4 cm	15.9 cm	13.1 cm
<b>LC50-12, -13</b>	36.9 cm	19.3 cm	6.4 cm	20.6 cm	14.9 cm

2

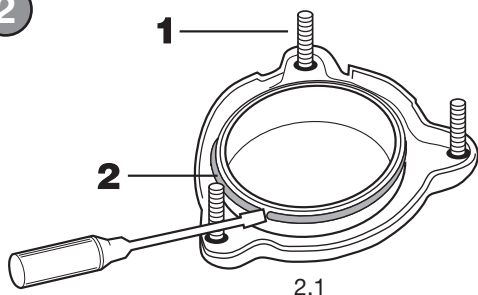

2.1

3

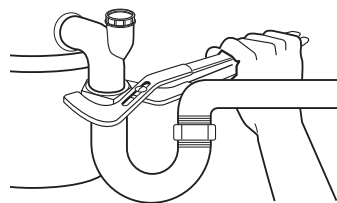

3.1

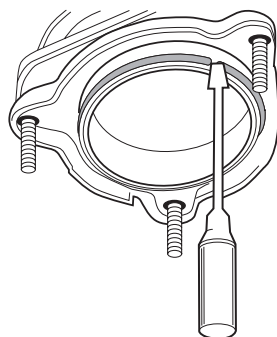

3.3

## 1 CHECK INSTALLATION DIMENSIONS

1. Disposer Height
2. Distance from bottom of sink bowl to centerline of discharge outlet. (Add 12 mm when stainless steel sink is used.)
3. Distance from centerline of the discharge outlet to end of discharge tube.
4. Disposer Width
5. Distance from disposer vertical centerline to centerline of trap connection.

To properly drain and prevent standing water in the disposer, the waste pipe entering the wall must be lower than the disposer discharge outlet.

## 2 DISASSEMBLE NEW DISPOSER MOUNTING ASSEMBLY

### ⚠ CAUTION

#### PERSONAL INJURY

Wearing safety glasses is recommended during the installation of the food waste disposer.

1. Turn mounting assembly over (see Figure 2.1) and loosen three mounting screws (1) until you can access snap ring (2).
2. Use screwdriver to pry snap ring off of sink flange. Mounting assembly will now come apart.
3. Set mounting assembly aside. This will be used in Instruction 5.

**IF REPLACING AN EXISTING DISPOSER, CONTINUE WITH INSTRUCTION 3.**

**IF THIS IS A FIRST TIME INSTALLATION, SKIP AHEAD TO INSTRUCTION 4.**

## 3 REMOVE EXISTING DISPOSER

### ⚠ CAUTION

#### PERSONAL INJURY

To avoid personal injury, do not position your head or body under disposer; the unit could fall during installation.

### ⚠ DANGER

#### ELECTRICAL SHOCK

- To avoid electrical shock, disconnect power before installing or servicing disposer. Turn off electrical power at fuse box or circuit breaker or if equipped unplug disposer electrical power plug from wall outlet.
- Improper connection of equipment earth (grounded) conductor can result in electric shock.

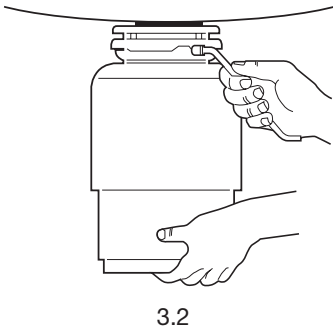

3.2

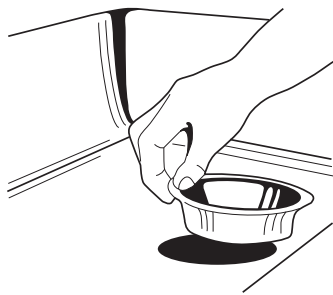

3.4

4

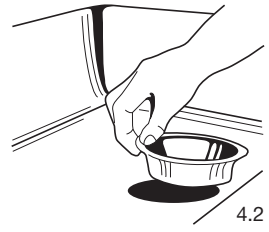
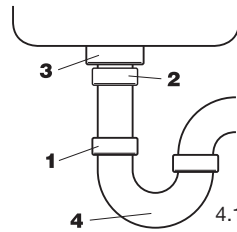

4.2

5

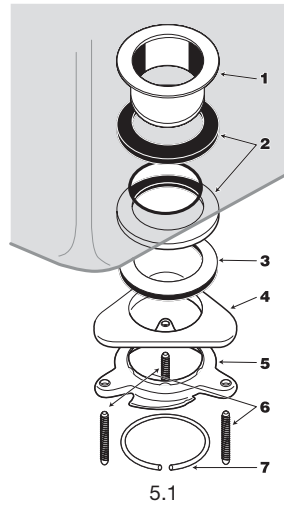

5.1

4

#### DISCONNECT SINK DRAIN

1. If your disposer is equipped with an electric plug and cord connection, unplug power plug from electrical wall outlet. If your disposer is not equipped with an electrical plug and cord connection, contact an electrician to disconnect the old disposer plus install an earth (grounded) electrical wall outlet for the new disposer connection that must be compliant to all local electrical codes.
2. Disconnect drain trap from disposer waste discharge tube with adjustable pliers (see Figure 3.1). Also disconnect dishwasher drain connection, if applicable.
3. Support disposer with one hand and insert end of wrenchette or screwdriver into right side of one mounting lug on lower mounting ring (see Figure 3.2). Lift disposer slightly and remove from mounting by pushing or pulling wrenchette or screwdriver to left (disposer may be heavy; provide support).
4. Loosen three mounting screws, pry snap ring off with screwdriver, and remove old mounting assembly (see Figure 3.3). Some mounting assembly removal requires additional tools.
5. Push old sink flange up through sink hole (see Figure 3.4). Skip ahead to Instruction 5.

1. Loosen nut (1) at top of trap (4) with pipe wrench (see Figure 4.1).
2. Loosen nut (2) at top of extension pipe. Remove extension pipe.
3. Loosen nut (3) at base of sink flange.
4. Push sink flange up through sink hole and remove it (see Figure 4.2).
5. Clean sink flange area of any putty or other debris.

**NOTE:** The sink hole may have to be enlarged to accept the disposer sink flange. Sink hole enlargement tools are available from your InSinkErator Dealer.

5

#### ATTACH UPPER MOUNTING ASSEMBLY TO SINK

Reference Figure 5.1.

1. Place one of two rubber gaskets (2) under sink flange (1). Ensure sink hole area is clear of debris and place sink flange/gasket into sink hole. You may wish to place a weighted object in the sink to hold the sink flange in place. (Place a towel under object to prevent scratching.)
2. Working from under the sink, slip second rubber gasket (2), fiber gasket (optional) (3) and metal backup ring (4) (flat side up) over the sink flange.
3. Holding second rubber gasket, fiber gasket (optional) and metal backup ring in place, slip mounting ring (5) over sink flange so it seats against backup ring.
4. With the rubber gasket, fiber gasket (optional), backup ring, and mounting ring tight against sink bottom, slide snap ring (7) onto sink flange until it pops into groove on flange.
5. Tighten three mounting screws (6) up to sink until mounting assembly is seated tightly and evenly against sink.

6

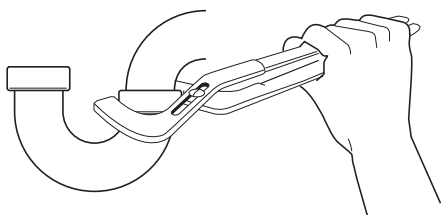

6.1

7

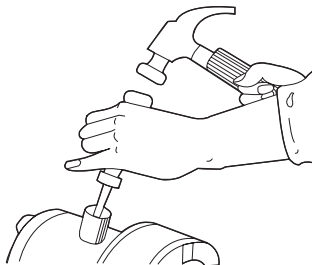

7.1

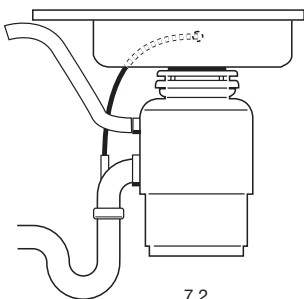

7.2

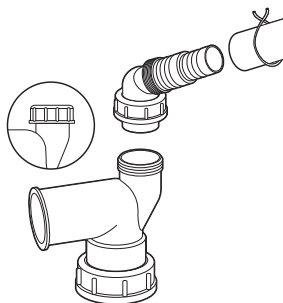

7.3

6

## CLEAN SINK WASTE PIPE

Failure to clean sink waste pipe line may result in waste pipe blockage.

1. Remove trap. (See Figure 6.1)
2. With drain auger, clear away all hardened waste material in horizontal drain line running from drain trap to main pipe.

**IF YOU ARE NOT CONNECTING A DISHWASHER TO DISPOSER, SKIP AHEAD TO INSTRUCTION 8.**

7

## DISHWASHER ATTACHMENT AND OVERFLOW CONNECTION

**DOES NOT APPLY TO AUSTRALIA/NEW ZEALAND** In Australia, it is suggested that the dishwasher units be connected to IPLEX/ COROMA dishwasher spigot for maximum efficiency.

Wastewater from a dishwasher can be plumbed into the disposer through the inlet access on the upper part of the disposer. There is a plug on the inside of the inlet tube on all models. Once removed, the knockout plug cannot be replaced.

**NOTE:** If the dishwasher connection is made without removing the plug, the dishwasher may overflow. (Connections must comply with local plumbing codes.)

### REMOVE KNOCKOUT PLUG

1. Lay disposer on its side and insert screwdriver into dishwasher inlet so tip rests on outer edge of knockout plug.
2. Tap end of screwdriver handle with hammer until molded plug breaks loose (see Figure 7.1).
3. Remove loose knockout plug from inside disposer.

### THE SINK OVERFLOW

The sink overflow may be connected to the overflow tube on the tailpipe (see Figure 7.2). Remove the overflow connector cap and blue plastic seal from the end of the overflow tube (see Figure 7.3). Utilizing the nut, connect the overflow hose to the tailpipe.

**NOTE:** The straight discharge tube for use in Australia does not have an overflow connection tube. In the UK, waste trap kit, which does not include the sink overflow kit, is available from your local InSinkErator dealer.

*(installation continued on reverse)*

InSinkErator Division  
Suite 6, Building 6  
Hatters Lane,  
Croxley Green Business Park  
Watford HERTS WD18 8YH  
United Kingdom  
Sales Tel: (0) 1 923 297 880  
Service Tel: (0) 800 389 3715  
www.insinkerator.co.uk

InSinkErator Division  
471 Mountain Highway  
Bayswater Vic 3153, Australia  
Sales Tel: 61 03 9720 5599  
Service Tel: 1 300 136 205  
www.insinkerator.com.au

Parex Industries Ltd.  
5 Tolich Place, Henderson  
P.O. Box 21-102  
Auckland, New Zealand 0610  
Sales Tel: 64 9 836 6566  
Service Tel: 0800 200 510  
www.parex.co.nz

InSinkErator Division  
Emerson Electric Co.  
4700 21st Street  
Racine, WI 53406-5093  
USA  
Sales/Service Tel:  
262-554-3652  
www.insinkerator.com/  
worldmap.html

KAL Group  
4078 Kingswood Road,  
Citywest Business Park  
Dublin, Ireland  
Tel: 01 413 6481,  
01 413 6400  
Fax: 01 413 6464  
Email: info@kal.ie

Evolution 100: Australia Pat. No. 307603, 307769, 308385, and other foreign patents pending

Evolution 200: Australia Pat. No. 307601, 307769, 308695, 308385, and other foreign patents pending

8

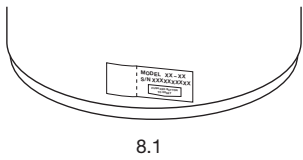

8.1

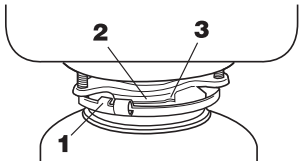

8.2

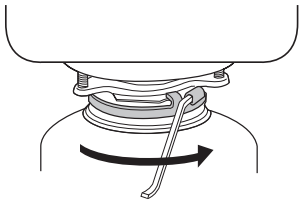

8.3

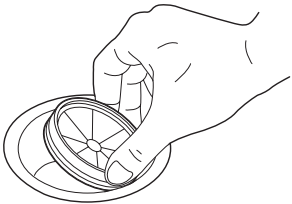

8.4

10

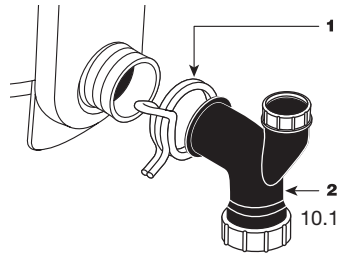

10.1

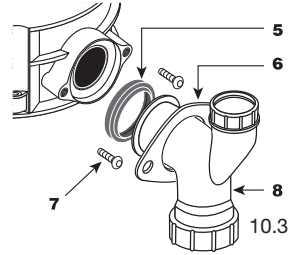

10.3

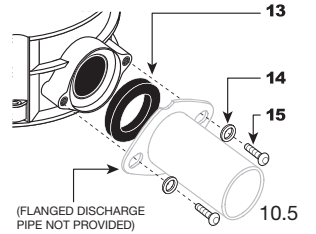

10.5

AUSTRALIA

8 CONNECT DISPOSER TO MOUNTING ASSEMBLY

10 ATTACH DISCHARGE TUBE TO WASTE DRAIN PIPE

**CAUTION**

**PERSONAL INJURY**

To avoid personal injury, do not position your head or body under disposer; the unit could fall during installation.

Clear any objects from inside the disposer grind chamber before mounting the disposer to the sink.

1. This product must be installed so that the motor reset button located on the bottom of the disposer is readily accessible. Keep this space clear of all objects.
2. Prior to connecting disposer to mounting assembly, detach the perforated portion of the specification label found at the base of the disposer, and set aside for Instruction 9 (See Figure 8.1).
3. Position disposer with three mounting tabs (1) aligned in position to slide over mounting tracks (2). (See Figure 8.2)
4. Lift disposer, insert top end (mounting gasket) into mounting assembly, and turn lower mounting ring to right (with wrenchette or adjustable pliers) until mounting tabs lock over ridges (3) on mounting ring tracks (see Figure 8.3). **Make sure all three mounting tabs are locked over ridges.** Disposer will now hang by itself.

**EVOLUTION 200 AND EVOLUTION 100, MODEL 65**

Insert sound baffle into sink opening, with flat side upward. (See Figure 8.4)

9 ATTACH SPECIFICATION LABEL

This specification label contains important information you will need to know in the event service is required.

1. Apply the label to the front side of the disposer, where it can be easily read.

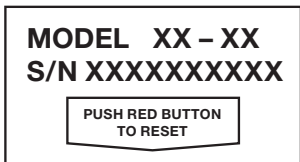

**CAUTION**

**PROPERTY DAMAGE**

- Wearing safety glasses is recommended during the installation of the food waste disposer.
- All Evolution 200 and Evolution 100 models must be connected to the supplied tailpipe with the supplied spring type hose clamp. (See Figure 10.1) In Australia it is required to use the supplied straight discharge tube with supplied spring type hose clamp. (See Figure 10.2) Failure to use the supplied tubes and spring type hose clamp will void the guarantee and possibly cause premature failure of the Anti-Vibration Tailpipe Mount™.
- Do not use plumber's putty on any other disposer connection other than on sink flange. Do not use thread sealants or pipe dope. These may harm disposer and cause property damage.
- Regularly inspect disposer and plumbing fittings for water leaks, as water leaks can cause property damage. Manufacturer cannot be held responsible for property damage as a result of water leaks.

**DISCHARGE TUBE INSTALLATION (EVOLUTION 200 AND EVOLUTION 100)**

1. Place discharge tube (2) into Anti-Vibration Tailpipe Mount™. Secure with spring type hose clamp (1). (See Figure 10.1)

**UK, NEW ZEALAND, HONG KONG AND IRELAND DISCHARGE TUBE INSTALLATION (MODELS 65, 55, 45)**

1. Place metal flange (6) over discharge tube (8). Insert rubber gasket (5) with gasket lip facing the metal flange into discharge tube. (See Figure 10.3)
2. Secure metal flange and discharge tube to disposer with two 13 mm bolts (7).



## AUSTRALIA ONLY

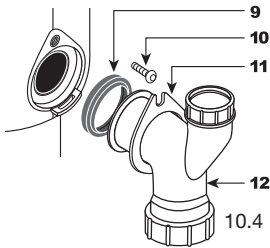
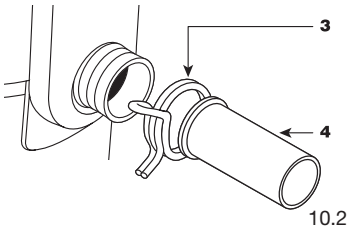

## IA ONLY

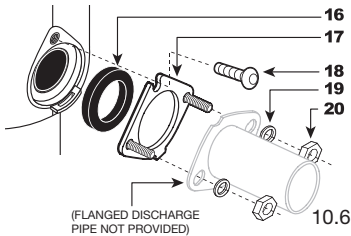

### UK, NEW ZEALAND, HONG KONG AND IRELAND DISCHARGE TUBE INSTALLATION (LC-50)

- Place metal flange (11) over discharge tube (12). (See Figure 10.4)
- Insert rubber gasket (9) with the gasket lip facing the metal flange into discharge tube (gasket may be pre-fitted in discharge tube). Secure metal flange and discharge tube to disposer with one 19 mm bolt (10) (Gasket will hold in place).

### AUSTRALIA DISCHARGE TUBE INSTALLATION (MODELS 65, 55, 45) (Optional straight pipe connection; connection to Caroma Connection not supplied. Attach discharge tube to waste pipe.)

- Insert rubber gasket (13) into discharge outlet. (See Figure 10.5)
- Attach flanged discharge pipe (not provided) using washers (14) and 19 mm 1/4 -20 bolts (15).

### AUSTRALIA DISCHARGE TUBE INSTALLATION (LC-50) (Optional straight pipe connection; connection to Caroma Connection not supplied. Attach discharge tube to waste pipe.)

- Place rubber gasket (16) between disposer and flange (17). (See Figure 10.6)
- Tighten flange with one 19 mm bolt (18). Attach flanged discharge pipe (not provided) using washers (19) and nuts (20).

### ALL DISPOSERS CONTINUE WITH STEPS 3-5

- Rotate disposer so that discharge tube is aligned with drain trap. (To prevent leaks, do not pull or bend discharge tube to drain trap.) If discharge tube is too short, you can purchase an extension from hardware store. (Disposer must remain in vertical position to prevent vibration.)
- Place nut, then ferrule on discharge tube (not supplied) and tighten on drain trap. (If you have a double sink, use separate drain traps for both sides of sink.)
- Ensure lower mounting ring is still securely locked over ridges on mounting flange. (See Figure 8.2)

11

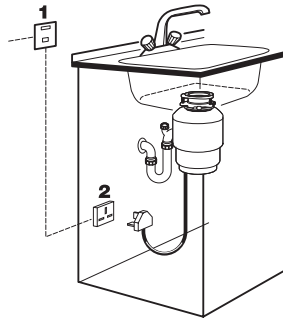

11.1

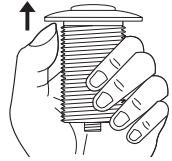

11.2

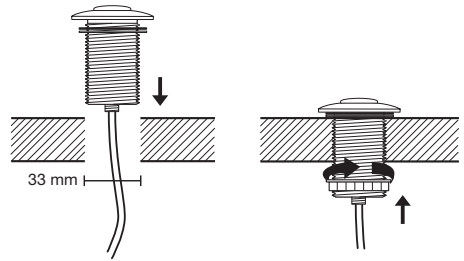

11.4

11

## CONNECT DISPOSER TO ELECTRICAL SUPPLY

### ⚠ DANGER

#### ELECTRICAL SHOCK

- To avoid electrical shock, disconnect power before installing or servicing disposer.
- If you are not thoroughly familiar with electric power, contact a qualified electrician to connect disposer to electrical circuit.
- If three-prong, earth (grounded) plug is used, plug must be inserted into three-hole, earth (grounded) receptacle.
- Do not modify plug provided with unit (if applicable).
- Improper connection of equipment earth (grounded) conductor can result in electric shock.
- All wiring must comply with local electrical codes.
- Do not attach earth wire (ground wire) to gas supply pipe.
- Do not reconnect electrical current at main service panel until proper earth (grounded) outlets are installed.
- If the supply cord is damaged, it must be replaced by the manufacturer, its service agent or similarly qualified-persons in order to avoid a hazard.

**NOTE:** You must have access to an earth (grounded) wall socket. Any additional socket should be fitted by a qualified electrician and properly earthed (grounded). The disposer is fitted with a molded plug and cable.

#### ON/OFF CONTROL

There are two types of controls for continuous-feed disposers: a double-pole switch and an air switch (built in for Evolution 200, Evolution 100, and Model 65; available as an accessory on all other models).

#### Double Pole Switch (1):

If a wall switch (not supplied) is required for your installation, it must have on/off markings and be installed by a qualified tradesperson. It should be located in a convenient position above the work surface with a minimum of 3 mm contact separation between each pole (20 ADP switches to BS 3676). In New Zealand, please refer to AS/NZS 3000:2007 for electrical installation. Connect to a 13 amp earth (grounded) wall socket (2) using a 13 amp cable. (See Figure 11.1)

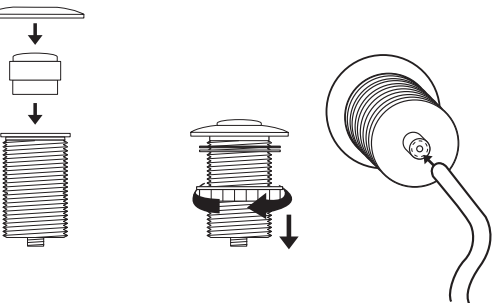

11.3

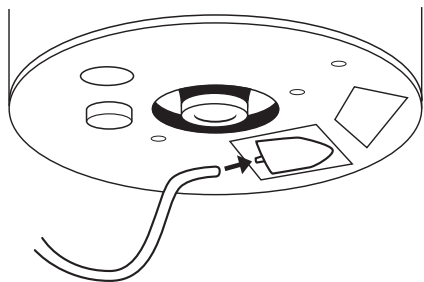

11.5

12

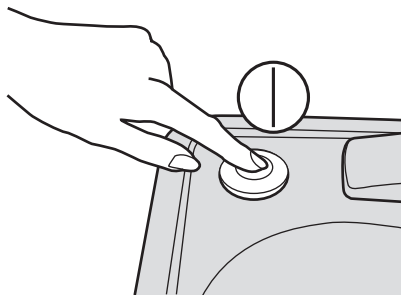

12.1

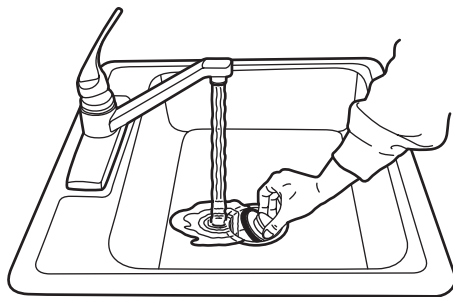

12.4

12

## INSTRUCTIONS PERTAINING TO RISK OF FIRE, ELECTRIC SHOCK AND INJURY

### ▲ WARNING

**When using electronic appliances, basic precautions are always to be followed, including:**

- In Australia, product may require approval of the relevant regulator and/or the sewerage system operator.
- If the air switch or wall switch fails to shut off or turn on disposer, unplug power cord plug and contact your qualified trade person.
- This product is designed to dispose of normal household food waste; inserting materials other than food waste into disposer could cause personal injury and/or property damage. To reduce the risk of injury, do not use the sink containing the disposer for purposes other than food preparation (such as baby bathing or washing hair).
- This appliance is not intended for use by persons (including children) with reduced physical, sensory or mental capabilities, or lack of experience and knowledge, unless they have been given supervision or instruction concerning use of appliance by a person responsible for their safety. Children should be supervised to ensure that they do not play with disposer. To reduce the risk of injury, close supervision is required when an appliance is used near children.
- When attempting to loosen a jam in the food waste disposer, switch off or unplug the appliance before attempting to free a jammed rotor. Use a self service wrenchette as described in the Releasing Disposer Jam section.
- Use long-handled tongs or pliers to remove objects from disposer.
- To reduce the risk of injury by materials that are expellable by a waste disposer, do not operate Evolution disposers without the sound baffle in place (See Figure 8.4). Place stopper in sink opening as shown in Figure 12.2 or 12.4. Do not put the following into a disposer: clam or oyster shells, caustic drain cleaners or similar products, glass, china, or plastic, large (whole) bones, metal (such as bottle caps, steel shot, tin cans, or utensils), hot grease or other hot liquids.
- Replace sound baffle/mounting gasket/splash baffle when worn to help prevent entry or ejection of material and water.
- When not using disposer, leave stopper in place to reduce risk of objects falling into disposer. Make sure disposer power switch is turned off.
- Before pressing reset button, attempting to clear jam, or removing objects from inside disposer, make sure disposer power switch is turned off.
- Do not insert hands or fingers into disposer.
- FIRE HAZARD: Do not store flammable items such as rags, paper, or aerosol cans near disposer. Do not store or use gasoline or other flammable vapors and liquids in vicinity of disposer.
- Do not dispose of the following in the disposer: paints, solvents, household cleaners and chemicals, automotive fluids, plastic wrap.

### Air Switch (Evolution 200, Evolution 100, Model 65, Model 55-1B A/S, 55-3B A/S and 45-1B A/S):

The Evolution 200, Evolution 100, and Model 65 disposers include a built-in air switch (Satin Nickel and Chrome finishes). An air switch activates/turns off the unit by sending a pulse of air to the control box.

#### AIR SWITCH INSTALLATION

The air switch includes two different button finishes. If you wish to change the button finish (optional), simply pry off the existing button and snap the other button finish onto the bellows. (See Figure 11.2)

1. Drill a 33 mm wide hole into the kitchen work top, or the corner of the sink unit, at the most convenient point for use. Some sink units may already have a suitable hole in them which can be exposed by removing the cap.
2. Remove the nut from the push button bellows, while keeping the stainless steel washer and rubber gasket in place. Push one end of the PVC tubing onto the spout of the push button bellows, feed the other end of the tube through the hole in the work top and through the nut underneath the work top. (See Figure 11.3)
3. Fit the push button bellows in the hole and then screw up the nut underneath the work top until it is hand tight. **Do not use a wrench to tighten the nut.** (See Figure 11.4)
4. Take the other end of the air tube and firmly push it over the spout of the air switch, which is located on the underside of the waste disposer. (See Figure 11.5)

#### DISABLING THE AIR SWITCH

The air switch can be disabled if wall switch operation is preferred. The disposer is shipped with the switch in the "off" position.

1. Push one end of the PVC tubing provided onto the spout of the push button bellows. (See Figure 11.3)
2. Take the other end of the air tube and push it over the spout of the air switch, which is located on the underside of the waste disposer. (See Figure 11.5)
3. Depress the air switch one time until you hear the switch "click." Remove and discard the push button bellows and PVC tubing. The disposer may now be activated by a wall switch.

**The disposer installation is complete. Read all operating and safety instructions in Instruction 12 before operating the disposer. Lastly, place stopper in sink in close position. Fill sink with water, remove stopper, turn disposer on and check for leaks.**

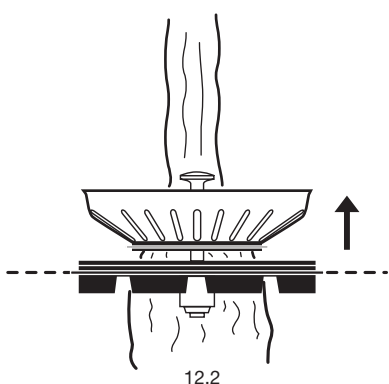

12.2

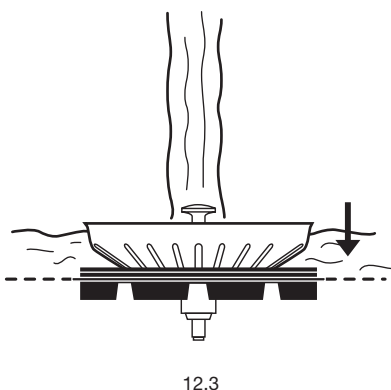

12.3

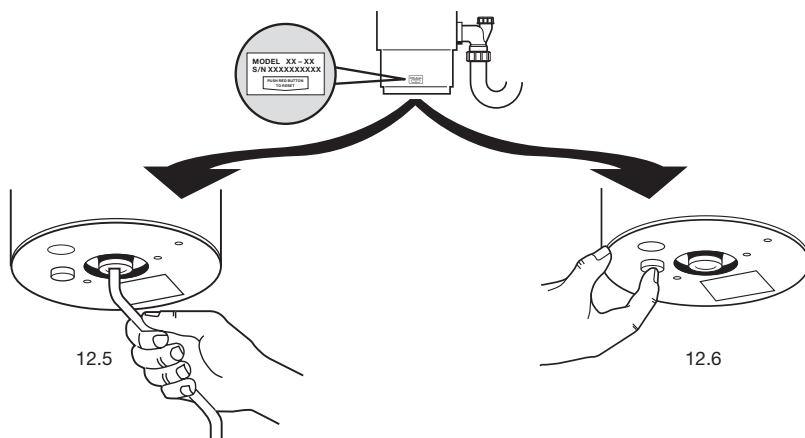

12.5

12.6

## ELECTRICAL SHOCK, OR INJURY TO PERSONS (SAVE THESE INSTRUCTIONS)

### OPERATING INSTRUCTIONS (EVOLUTION 200 AND EVOLUTION 100)

1. Remove strainer basket and plug from sink opening and run cold water.
2. Turn on wall switch or press air switch (see Figure 12.1) to start disposer.
3. Slowly insert food waste into disposer and position strainer basket and plug in upright position (allowing water to run through) to minimize noise and possible ejection of material while grinding (See Figure 12.2).
4. After grinding is complete, turn disposer off and run water for at least 15 seconds to flush drain line.
5. Strainer basket and plug also acts as a stopper in the lower position. (See Figure 12.3)

### OPERATING INSTRUCTIONS (MODELS 65, 55, 45, LC-50)

1. Remove stopper from sink opening and run cold water.
2. Turn on wall switch or press air switch (see Figure 12.1) to start disposer.
3. Slowly insert food waste into disposer and position stopper to minimize noise and possible ejection of material while grinding. (See Figure 12.4)
4. After grinding is complete, turn disposer off and run water for at least 15 seconds to flush drain line.

### DO...

- Grind food waste with minimum cold water flow of 5.7 liters per minute (1-1/2 G.P.M.).
- Grind hard material such as small bones and fruit pits to clean inside of grind chamber.
- Grind citrus, melon rinds, vegetables, and coffee grounds.
- After grinding, run water for at least 15 seconds to flush drain line.
- Switch off or unplug the appliance before attempting to free a jammed rotor with an implement.
- Maintain the area underneath the disposer of any objects to be sure you have access to the disposer reset button.

### DON'T...

- Don't use hot water when grinding food waste (although hot water can be drained into disposer between grinding periods).
- Don't turn off water or disposer until grinding is completed and only sound of motor and water running is heard.
- Don't grind large amounts of egg shells or fibrous materials like corn husks, artichokes, etc., to avoid possible pipe blockage.
- Don't grind non-food waste of any kind.
- Don't use this appliance to dispose of hard materials such as glass and metal.
- Don't ever pour fats, oils or grease down the sink – it will block your drains and the sewerage system.

- Don't fill disposer with a lot of vegetable peels all at once. Instead, turn the water and disposer on first and then feed the peels in gradually.
- Don't waste food. Nearly a quarter of the food we buy is thrown away untouched: salad, bread and cakes and fruit head the list. Three tips to stop waste and save you money: only buy, or cook, the portions you need for the meal; check the fridge and cupboard for food you haven't eaten—make it your next snack or freeze it; and make sure you leave that food off your next shopping list!

### CLEANING DISPOSER

Over time, grease/food particles may accumulate in the grind chamber and baffle, causing an unpleasant odor. To clean the disposer:

1. Turn off disposer and disconnect power supply.
2. Reach through sink opening and clean underside of splash baffle and inside upper lip of grind chamber with scouring pad.
3. Place stopper in sink opening and fill sink halfway with warm water.
4. Mix 60 ml baking soda with water. Turn disposer on and remove stopper from sink at same time to wash away loose particles.

### RELEASING DISPOSER JAM

If the motor stops while the disposer is operating, the disposer may be jammed. To release jam:

1. Turn disposer power and water off.
2. Insert one end of the self-service wrenchette into the center hole on the bottom of the disposer (see Figure 12.5). Work the wrenchette back and forth until it turns one full revolution. Remove wrenchette.
3. Reach into the disposer with tongs and remove object(s). Allow the disposer motor to cool for 3 - 5 minutes and lightly push red reset button on the disposer bottom (see Figure 12.6). (If the motor remains inoperative, check the service panel for tripped circuit breakers or blown fuses.)

## IN-HOME FULL SERVICE GUARANTEE

InSinkErator products are guaranteed against defects in material and workmanship for the period of the guarantee from the date of purchase.

Evolution 200: 6 years	Evolution 100: 5 years
Model 65: 4 years	Model 55: 3 years
Model 45: 2 years	LC-50: 1 year

### SERVICE

If service is required, contact an InSinkErator Authorized Service Center (see enclosed list) or your dealer. Guarantees are void if you remove your disposer after installation and attempt to repair it, or if the disposer is used for commercial purposes.