

Pet Feeder

Instruction Manual

PC-WSQ2W01

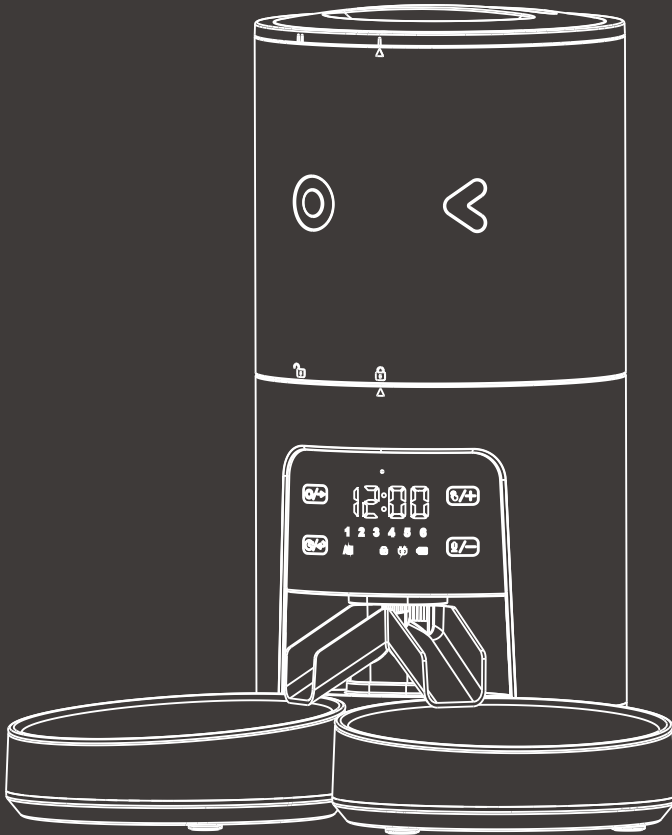

✉ HJ-Customer-Service@outlook.com

☎ (909)637-7665 | (909)637-7593

EST 9:00AM--17:00PM

Contents

Safety Instructions	1
Product Display	3
Control Panel	3
Product Specifications	5
Usage Instruction	6
Setting Guide	7
How to Clean	9
Troubleshooting	10
FCC Statement	11

Safety Instructions

Please read these instructions carefully before use and keep this manual for future reference.

1. Dispose of all packaging properly. Keep plastic bags away from children and pets to prevent suffocation.
2. Do NOT allow children to play with, in, or around the pet feeder. Please keep close supervision when using near children.
3. Keep batteries away from children to prevent swallowing when using.
4. Do NOT use the feeder with pets not able to reach the food bowl or with any physical disability.
5. Do NOT immerse the base in water, as it may damage the electronic components.
6. Do NOT place any foreign object in the pet feeder.
7. Do NOT use outdoors.
8. Check the feeder frequently to ensure it is operating properly.
9. Do NOT use wet or canned food.
10. Do NOT disassemble the feeder other than as instructed in this manual.
11. Do NOT use the feeder for anything other than its intended use.
12. Only use components recommended by the manufacturer, or it may cause damage to the feeder. Do not modify the pet feeder.
13. Stop using immediately if the feeder malfunctions or has been damaged. Do not repair it by yourself. Contact our after-sales service immediately for further instructions.
14. Always unplug when not in use and before cleaning.
15. Do not pull the power cord to disconnect.
16. Check the feeder is fully assembled before use. Do not plug in if there is water on the power cord or plug.
17. Keep the power cord clear of walking area to avoid tripping.

Caution





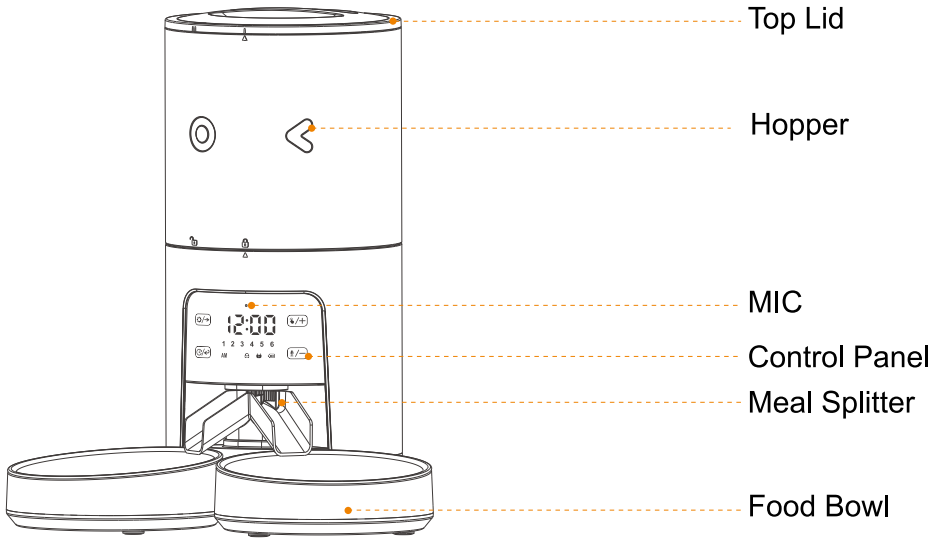

1. Do NOT allow pets to chew on or swallow any parts. You can purchase a cord conduit (a hard-plastic protector) to protect the power cord.
2. If an extension cord is necessary, use one with a proper rating.
3. Do NOT place the pet feeder under 4°C/40°F.
4. Use alkaline D batteries. Do NOT use rechargeable batteries.
5. Check the batteries regularly. Always replace with new batteries when leaving for a long period.
6. Do NOT lift the pet feeder by the lid. Hold the base with both hands and lift it in an upright position.
7. Suitable for dry food ONLY, with kibble size ranging from 5-18 mm/0.2-0.7 inches in diameter. Larger kibble may get stuck at the food outlet.
8. Do not put your fingers into the food outlet.

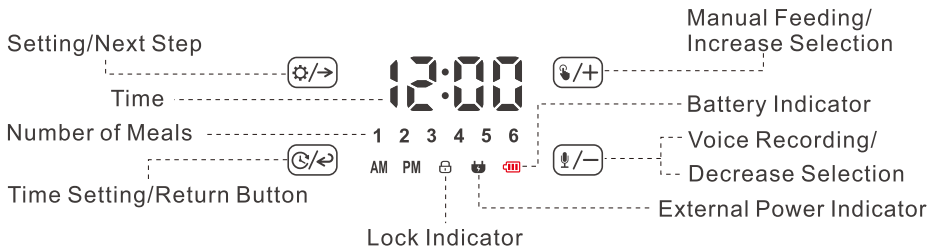

Product Display



Control Panel



Button	Description	Function
	Setting	Unlock status: Long press for 2s to set feeding parameters or to exit.
	Next Step	Short press to the next step.
	Time Setting	Unlock status: Long press for 2s to set the current time or to exit. Short press to set hour and minute.
	Return	Setting mode: Short press to return to the previous step.
	Recording	Standby: Short press--Play recording Long press--Record voice or cancel recording
	Decrease	Setting mode: Short press --Decrease value Long press – Decrease the value quickly
	Manual Feeding	Standby: Short press –Manual feeding
	Increase	Setting mode: Short press -- Increase value Long press –Increase the value quickly
	Reset	Hold both for 6s at the same time to restore the factory settings.
	Lock/Unlock	Hold both for 2s at the same time to lock/unlock. All buttons will be locked automatically after 90s without operating.
	Hour Format Switch	Hold both for 5s at the same time to switch between 12-hour format and 24-hour format.

Icon	Meaning
12:00	Current Time/Feeding Time. The initial setting time is 12:00.
5F 00	Slow feeding mode. The interval time per portion can be set from 0-10 min.
F - 00	Set the portion of each meal. Up to 50 portions.
1 2 3 4 5 6	Number of meals Feeding: The digit is always on. No Feeding: The digit is not displayed.
	Light up when all buttons are locked.
	Light up when connected to the external power.
	Flashing: No batteries Solid: Batteries installed Red Light Flashing: Low battery

If powered by the adapter, the display screen will always be on. If powered by batteries only, without operation for 2 minutes, the display screen will turn off. Pressing any button can awaken it.

Product Specifications

Product Model	PC-WSQ2W01-6WT-PT
Input	DC 5V
Dimensions	345*355*410 mm
Dual Power	5V Power Adapter; 3 D-Cell Batteries (Not Provided)
Capacity	6L
Feeding Setting	1-50 Portions; 1/10 Cup Per Portion; 6 Meals Per Day

Usage Instruction

1. Dual Power Supply

The feeder can be powered by an external power source or battery alone. For uninterrupted operation during a power outage, use both simultaneously.

Plug in the power adapter and ensure the power switch is in the "I" position.

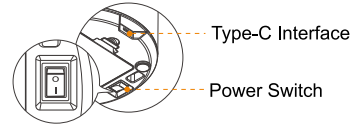

2) Remove the base, and open the battery compartment. Install three alkaline D batteries (not included), and ensure they are in the correct position.

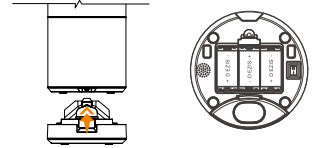

2. Install Food Bowls

1) Secure the meal splitter to the bowl holder, place two bowls under the holder, and put the feeder onto the meal splitter.

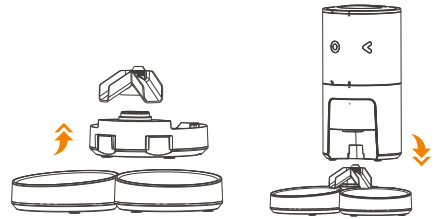

2) Rotate the meal splitter to adjust the amount of food.

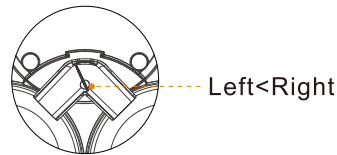
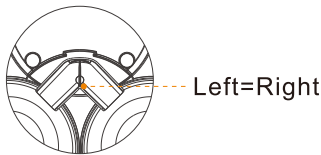

3. Remove and Lock Lid

Turn the lid to remove or lock it.

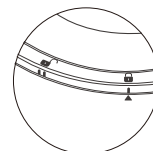
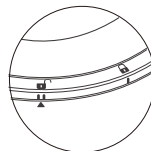



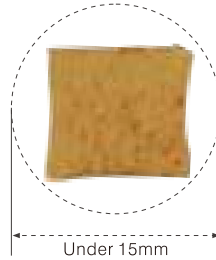
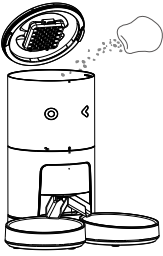

4. Fill in Food











Recommended kibble size: 5-15 mm/0.2-0.6 inches in diameter.



Setting Guide





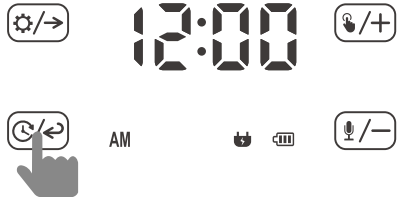

1. Ensure the feeder is unlocked – If the  is lit, press and hold     until you hear two beeps to unlock the feeder.

2. Set Current Time

Long press   until the hour digits start flashing. Press   or   to set the correct hour, and then short press   to save. Repeat to set the minute. Long press   to exit.







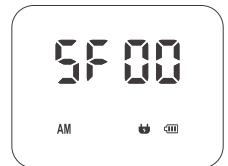



3. Set Slow Feed Time

Long press   to enter the feeding parameters setting. Press   or   to set the interval time per portion, which can be set up to 10 min.



4. Set Meal Time and Portion

1) Short press   to the next step, and the digit "1" starts flashing. Short press   to enter the first meal setting. Short press   or   to set feeding time.



2) Once feeding time is set and saved, the feeder will switch to portion mode. The screen will display "F-XX".

For example:

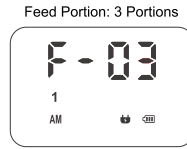

F-00	No Feeding/Cancel Feeding
F-01	1 Portion, about 1/10 Cup
F-02	2 Portions, about 2/10 Cup
F-03	3 Portions, about 3/10 Cup
F-04	4 Portions, about 4/10 Cup
...	...
F-50	50 Portions, about 5 Cups

5. Set Other Meals

Repeat the process of Set Meal Time and Portion. Long press to save once you set all meals.

6. About Recording

1) Start recording

In standby, press and hold until you hear a beep, and continue to hold (maximum recording time is 10 seconds). Release the button when you hear a beep to finish.

2) Play the recording

In standby, short press to hear the recording.

3) Cancel the recording

In standby, long press until you hear a beep and release immediately to cancel the recording.

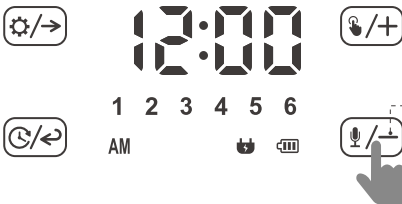

Long press to record or cancel
Short press to play

How to Clean

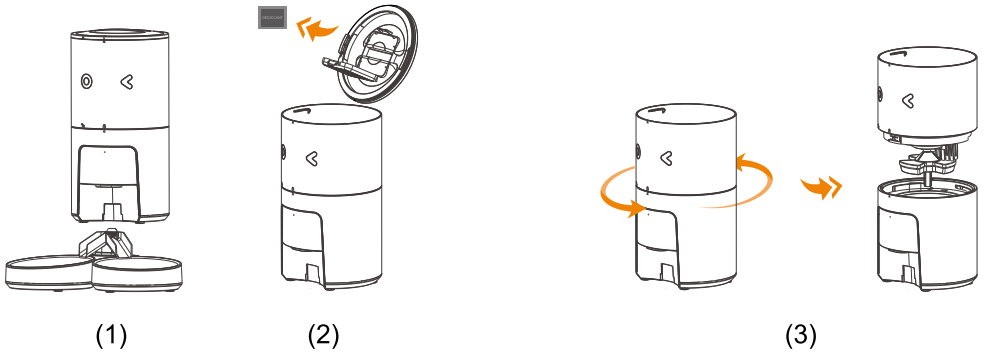

- (1) Remove two food bowls and the bowl holder.
- (2) Take out the desiccant and empty the hopper.
- (3) Rotate the hopper counterclockwise to separate it from the base.

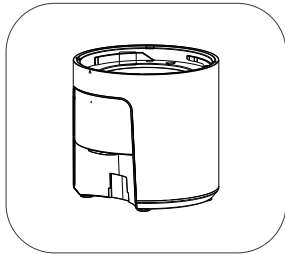



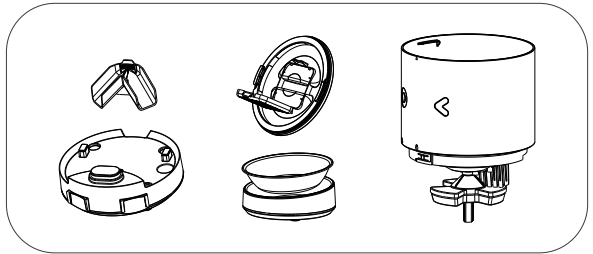



The base cannot be submerged in water.



Food bowl, bowl holder, meal splitter, lid and hopper can be washed.

Troubleshooting

Problem	Solution
The screen shows E-01	It indicates that the food outlet is blocked. Please clean the food outlet in time.
The screen shows E-02	It indicates abnormal feeding. Please check whether there are foreign objects in the hopper or the food is too large.
Press the button but doesn't work	Press and hold   for 2s to unlock the feeder.
How to cancel a meal	Change the feeding portion to F-00; the number of this meal will not be shown on the screen.
How to change a meal pre-set	In unlocked status, long press  to enter meal setting, and skip the slow food setting. When digit "1" starts flashing, press  or  to choose the number of the meal you want to change. Long press  to save.
The screen is off	If powered by batteries only, the display screen will turn off. Pressing any button can awaken it.
The food amount is not the same as the set	The food amount per portion varies according to the size of the food. Please test the food amount per portion several times manually before setting.

FCC Statement

This device complies with part 15 of the FCC Rules. Operation is subject to the following two conditions:

- (1) This device may not cause harmful interference.
- (2) This device must accept any interference received, including interference that may cause undesired operation.

Any changes or modifications not expressly approved by the party responsible for compliance could void the user's authority to operate the equipment.

NOTE: This equipment has been tested and found to comply with the limits for a Class B digital device, pursuant to part 15 of the FCC Rules. These limits are designed to provide reasonable protection against harmful interference in a residential installation. This equipment generates, uses and can radiate radio frequency energy and, if not installed and used in accordance with the instructions, may cause harmful interference to radio communications. However, there is no guarantee that interference will not occur in a particular installation. If this equipment does cause harmful interference to radio or television reception, which can be determined by turning the equipment off and on, the user is encouraged to try to correct the interference by one or more of the following measures:

- Reorient or relocate the receiving antenna.
- Increase the separation between the equipment and receiver.
- Connect the equipment into an outlet on a circuit different from that to which the receiver is connected.
- Consult the dealer or an experienced radio/TV technician for help.

To maintain compliance with FCC RF Exposure Guidelines, this equipment should be installed and operated with a minimum distance of 20 cm between the radiator and your body. And use only the supplied antenna.



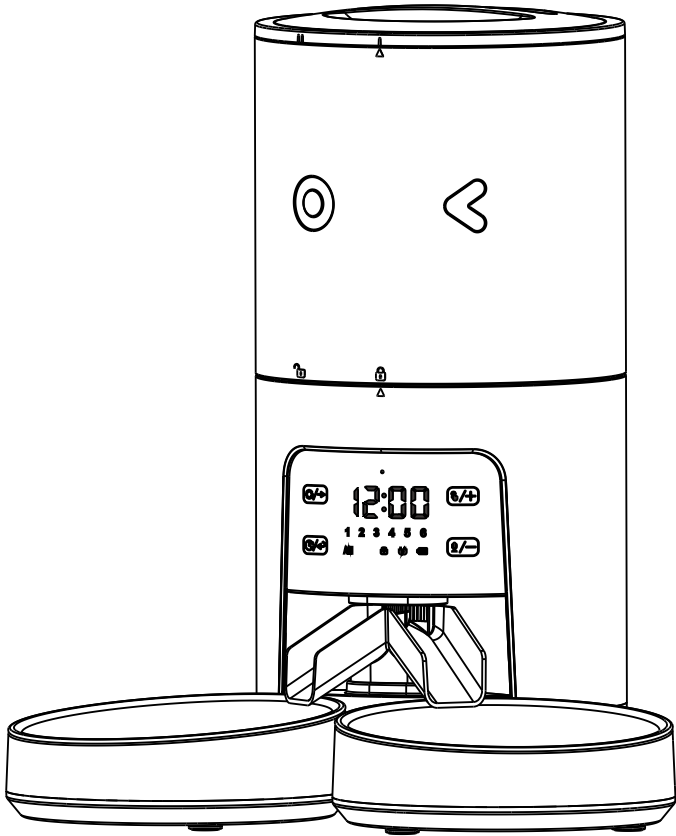

Technical Support

(909)637-7665 | (909)637-7593

Other Info

HJ-Customer-Service@outlook.com

Thank you for choosing this product. We strive to provide you with the best quality products and service in the industry. Should you have any issues, please don't hesitate to contact us.