

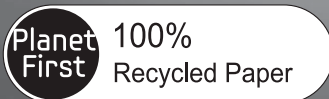

DW60H9970 Series
DW60H9950 Series

Dishwasher user manual



This manual is made with 100% recycled paper.

imagine the possibilities

Thank you for purchasing this Samsung product.



Contents

SAFETY INSTRUCTIONS

3

SETTING UP YOUR DISHWASHER

10

- 10 Checking the parts and control panel
- 15 Cycle selector
- 15 Progress displays
- 16 Meeting the installation requirements
- 18 Installing your dishwasher
(only for installing under the sink)

BEFORE USING THE PRODUCT FOR THE FIRST TIME

20

- 20 Setting mode
- 21 Using detergent

LOADING YOUR DISHWASHER

22

- 22 Dishwashing guidelines
- 23 Adjusting the height of the upper rack
- 24 Removing the upper rack
- 24 Loading the lower rack
- 25 Loading the upper rack
- 26 Using the 3rd (cutlery) rack (for some models)
- 27 Using rinse aid

CLEANING AND MAINTAINING YOUR DISHWASHER

28

- 28 Cleaning the exterior
- 28 Cleaning the wash cabinet
- 29 Cleaning the filters
- 30 Cleaning the nozzles
- 30 Storing your dishwasher

TROUBLESHOOTING AND INFORMATION CODES

31

- 31 Check these points if your dishwasher...
- 33 Information codes

PROGRAMME CHART

34

- 34 Programme chart

APPENDIX

35

- 35 Disposing the dishwasher and helping the environment
- 35 Declaration of conformity
- 35 Specifications

FOR STANDARD TEST

36

Safety instructions

Congratulations on your new Samsung dishwasher. This manual contains important information on the installation, use and care of your appliance. Please take time to read this manual to take full advantage of your dishwasher's many benefits and features.

WHAT YOU NEED TO KNOW ABOUT SAFETY INSTRUCTIONS











Please read this manual thoroughly to ensure that you know how to safely and efficiently operate the extensive features and functions of your new appliance and retain it at a safe place near the appliance for your future reference. Use this appliance only for its intended purpose as described in this user manual.

Warning and important safety instructions in this manual do not cover all possible conditions and situations that may occur. It is your responsibility to use common sense, caution, and care when installing, maintaining, and operating your dishwasher.

Because the following operating instructions cover various models, the characteristics of your dishwasher may differ slightly from those described in this manual and not all warning signs may be applicable. If you have any questions or concerns, contact your nearest service center or find help and information online at www.samsung.com.

IMPORTANT SAFETY SYMBOLS AND PRECAUTIONS

Important safety symbols







 WARNING	Hazards or unsafe practices that may result in severe personal injury and/or property damage.
 CAUTION	Hazards or unsafe practices that may result in personal injury and/or property damage.
 CAUTION	To reduce the risk of fire, explosion, electric shock, or personal injury when using your dishwasher, follow these basic safety precautions:
	Do NOT attempt.
	Do NOT disassemble.
	Do NOT touch.
	Follow directions explicitly.
	Unplug the power plug from the wall socket.
	Make sure the appliance is grounded to prevent electric shock.
	Call the service centre for help.
	Note

These warning symbols are here to prevent injury to you and others. Please follow them explicitly.

Keep these instructions in a safe place and ensure that new users are familiar with the content. Pass them on to any future owner.

Safety instructions

Important safety precautions

-  This appliance conforms to current safety requirements. Inappropriate use can, however, lead to personal injury and damage to property.
To avoid the risk of accidents and damage to the appliance, please read these instructions carefully before using it for the first time. They contain important information on its safety, use and maintenance.
-  As with any equipment using electricity and moving parts, potential hazards exist. To safely operate this appliance, become familiar with its operation and exercise care when using it.
-  Do not let children (or pets) play on or in your dishwasher. The dishwasher door does not open easily from the inside, and children may be seriously injured if trapped inside.
-  Children should be supervised to ensure that they do not play with the appliance.
-  If the plug (power supply cord) is damaged, it must be replaced by the manufacturer or its service agent or a similarly qualified person in order to avoid a hazard.
-  This appliance must be positioned to be accessible to the power plug after installation, the water supply tabs and the drain pipes.

INSTRUCTION ABOUT THE WEEE MARK

Correct Disposal of This Product (Waste Electrical & Electronic Equipment)

(Applicable in countries with separate collection systems)

This marking on the product, accessories or literature indicates that the product and its electronic accessories (e.g. charger, headset, USB cable) should not be disposed of with other household waste at the end of their working life. To prevent possible harm to the environment or human health from uncontrolled waste disposal, please separate these items from other types of waste and recycle them responsibly to promote the sustainable reuse of material resources.

Household users should contact either the retailer where they purchased this product, or their local government office, for details of where and how they can take these items for environmentally safe recycling.

Business users should contact their supplier and check the terms and conditions of the purchase contract. This product and its electronic accessories should not be mixed with other commercial wastes for disposal.





To reduce the risk of fire, electric shock, or injury to persons when using your appliance, follow basic precautions, including the following:

This appliance is not to be used by persons (including children) with reduced physical, sensory or mental capabilities, or lack of experience and knowledge, unless they have been given supervision or instruction concerning use of the appliance by a person responsible for their safety.

Children should be supervised to ensure that they do not play with the appliance.

For use in Europe: This appliance can be used by children aged from 8 years and above and persons with reduced physical, sensory or mental capabilities or lack of experience and knowledge if they have been given supervision or instruction concerning use of the appliance in a safe way and understand the hazards involved. Children shall not play with the appliance. Cleaning and user maintenance shall not be made by children without supervision.

If the supply cord is damaged, it must be replaced by the manufacturer, its service agent or similarly qualified persons in order to avoid a hazard.

For appliances with ventilation openings in the base, that a carpet must not obstruct the openings.

The new hose-sets supplied with the appliance are to be used and that old hose-sets should not be reused.

CAUTION: In order to avoid a hazard due to inadvertent resetting of the thermal cut-out, this appliance must not be supplied through an external switching device, such as a timer, or connected to a circuit that is regularly switched on and off by the utility.

Safety instructions

The door should not be left in the open position since this could present a tripping hazard.

WARNING: Knives and other utensils with sharp points must be loaded in the basket with their points down or placed in a horizontal position.

This appliance is intended to be used in household and similar applications such as:

- staff kitchen areas in shops, offices and other working environments;
- farm houses;
- by clients in hotels, motels and other residential type environments;
- bed and breakfast type environments.

INSTRUCTIONS WHEN USING YOUR DISHWASHER

 This dishwasher is not designed for commercial use. It is intended for use in domestic households and in similar working and residential environments such as:

- Shops
- Offices and showrooms

and by residents in establishments such as:

- Hostels and guest houses.

 It must only be used as a domestic appliance as specified in these user manual, for cleaning domestic crockery and cutlery.

Any other usage is not supported by the manufacturer and could be dangerous.

 The manufacturer cannot be held liable for damage resulting from incorrect or improper use or operation.

 **WARNING** Do not use solvents in the dishwasher. Danger of explosion.

 **WARNING** Do not inhale or ingest dishwasher detergent. Dishwasher detergents contain irritant or corrosive ingredients which can cause burning in the nose, mouth and throat if swallowed, or inhibit breathing. Consult a doctor immediately if detergent has been swallowed or inhaled.

 **CAUTION** Avoid leaving the door open unnecessarily, as you could trip over it.

 **CAUTION** Do not sit or lean on the opened door. This could cause the dishwasher to tip and be damaged, and you could get injured.

 Only use detergent and rinse aid formulated for domestic dishwashers. Do not use washing-up liquid.

 **CAUTION** Do not use the strong acid cleaning agent.

 Do not fill the rinse aid reservoir with powder or liquid detergent. This will cause serious damage to the reservoir.

 Inadvertently filling the salt reservoir with powder or liquid dishwasher detergent will damage the water softener. Make sure you have picked up the correct packet of dishwasher salt before filling the salt reservoir.

 Please only use special coarse grained dishwasher salt for reactivation, as other salts may contain insoluble additives which can impair the functioning of the softener.

 In an appliance with a cutlery basket (depending on model), cutlery is cleaned and dried more if placed in efficiently the basket with the handles downwards. However, to avoid the risk of injury, place knives and forks etc. with the handles upwards.

 Plastic items which cannot withstand being washed in hot water, such as disposable plastic containers, or plastic cutlery and crockery should not be cleaned in the dishwasher. The high temperatures in the dishwasher may cause them to melt or lose shape.

 On models with **Delay Start** function, make sure that the dispenser is dry before adding detergent. Wipe dry if necessary. Detergent will clog if poured into a damp dispenser and may not be thoroughly dispersed.

 Knives and other utensils with sharp points must be loaded in the basket with their points down or placed in a horizontal position.

INSTRUCTIONS FOR PROTECTING YOUR CHILDREN

 This appliance is not a toy! To avoid the risk of injury, keep children well away and do not allow them to play in or around the dishwasher or to use the controls. They will not understand the potential dangers posed by it. They should be supervised whenever you are working in the kitchen. There is also a danger that children playing might shut themselves in the dishwasher.















 This appliance can be used by children aged from 8 years and above and persons with reduced physical, sensory or mental capabilities or lack of experience and knowledge if they have been given supervision or instruction concerning use of the appliance in a safe way and understand the hazards involved. Children shall not play with the appliance. Cleaning and user maintenance shall not be made by children without supervision.













 Older children may only use the dishwasher when its operation has been clearly explained to them and they are able to use it safely, recognising the dangers of misuse.

 **KEEP CHILDREN AWAY FROM DETERGENTS!** Dishwasher detergents contain irritant and corrosive ingredients which can cause burning in the mouth, nose and throat if swallowed, or inhibit breathing. Keep children away from the dishwasher when the door is open. There could still be detergent residues in the cabinet. Consult a doctor immediately if your child has swallowed or inhaled detergent.

Safety instructions

INSTRUCTIONS FOR INSTALLING YOUR DISHWASHER

-  **WARNING** Before setting up the appliance, check it for any externally visible damage. Under no circumstances should you use a damaged appliance. A damaged appliance could be dangerous.
-  **CAUTION** The dishwasher must only be plugged into the electricity supply via a suitable switched socket. The electrical socket must be easily accessible after the dishwasher is installed so that it can be disconnected from the electricity supply at any time. (Refer to the **“Checking the parts and control panel”** section on page 10.)
-  **WARNING** There must be no electrical sockets behind the dishwasher. Danger of overheating and fire risk if the dishwasher were to be pushed up against a plug.
-  **WARNING** The dishwasher must not be installed under a hob. The high radiant temperatures which are sometimes generated by a hob could damage the dishwasher. For the same reason it should not be installed next to open fires or other appliances which give off heat, such as heaters etc.
-  Do not connect the dishwasher to the mains supply until it has been fully installed and any adjustment has been made to the door springs.
-  **CAUTION** Before connecting the appliance, check that the connection data on the data plate (voltage and connected load) match the mains electricity supply. If in any doubt, consult a qualified electrician.
-  The electrical safety of this appliance can only be guaranteed when continuity is complete between it and an effective grounding system. It is most important that this basic safety requirement is present and regularly tested and where there is any doubt the electrical system in the house should be checked by a qualified electrician.
The manufacturer cannot be held liable for the consequences of an inadequate grounding system (e.g. electric shock).
-  **CAUTION** Do not connect the appliance to the mains electricity supply by a multi-socket unit or an extension lead. These do not guarantee the required safety of the appliance (e.g. danger of overheating).
-  ★ This appliance may only be installed in mobile installations such as ships if a risk assessment of the installation has been carried out by a suitably qualified engineer.
-  **CAUTION** The plastic housing of the water connection contains an electrical component. The housing must not be submerged in water.
-  Do not cut the water inlet hose, even if it is too long.
-  Installation, maintenance and repairs may only be carried out by a suitably qualified and competent person in strict accordance with current national and local safety regulations. Repairs and other work by unqualified persons can be dangerous. The manufacturer cannot be held liable for unauthorised work.
-  **CAUTION** The integrated waterproof system offers protection from water damage, provided the following conditions are met:
- The dishwasher is correctly installed and plumbed in.
 - The dishwasher is properly maintained and parts are replaced where it can be seen that this is necessary.
 - The stopcock has been turned off when the appliance is not used for a longer period of time (e.g. during holidays).
 - The waterproof system will work even if the appliance is switched off. However, the appliance must remain connected to the electricity supply.
-  **WARNING** A damaged appliance can be dangerous. If the dishwasher gets damaged, switch it off at the mains and call your dealer or the service department.
-  Do not attempt repairs. Unauthorised repairs could result in unforeseen dangers for the user, for which the manufacturer cannot accept liability. Repairs should only be undertaken by an approved service technician.

-  Faulty components must only be replaced by original spare parts. Only when these parts are fitted can the safety of the appliance can be guaranteed.
-  Always disconnect the dishwasher from the electrical supply for maintenance work (switch off at the wall socket and remove the plug).
-  If the connection cable is damaged it must be replaced with a special cable, available from the manufacturer. For safety reasons, this must only be fitted by the service department or an authorised service technician.
-  In countries where there are areas which may be subject to infestation by cockroaches or other vermin, pay particular attention to keeping the appliance and its surroundings in a clean condition at all times. Any damage which may be caused by cockroaches or other vermin will not be covered by the guarantee.
-  In the event of a fault or for cleaning purposes, the appliance is only completely isolated from the electricity supply when:
- it is switched off at the wall socket and the plug is withdrawn, or
 - it is switched off at the mains, or
 - the mains fuse is disconnected, or
 - the screw-out fuse is removed (in countries where this is applicable).
-  Do not make any alterations to the appliance, unless authorised to do so by the manufacturer.
-  Never open the casing/housing of the appliance.
-  Tempering with electrical connections or components and mechanical parts is highly dangerous and can cause operational faults or electric shock.
-  While the appliance is under guarantee, repairs should only be undertaken by a service technician authorised by the manufacturer. Otherwise the guarantee will be invalidated.
-  When installing the product, make sure there is space at the top, left, right and back of the product to ensure proper ventilation.
-  If there is insufficient space between the product and the sink, it may damage the sink or allow mold to grow.
-  Make sure that your dishwasher's hardness level setting is correct as your area. (Refer to the **"Brightness mode (Pocket LED brightness setting)"** section on page 20.)

Setting up your dishwasher

Be sure to have your technician follow these instructions closely to ensure the safe and normal operation of your new dishwasher.

CHECKING THE PARTS AND CONTROL PANEL

When your dishwasher has been unpacked, make sure that you've received all the parts shown below. If your dishwasher was damaged during shipping, or if you do not have all the parts, contact Samsung Customer Service or your Samsung dealer.

 **WARNING** Keep the packaging out of the reach of children to ensure their safety, after unpacking your dishwasher.

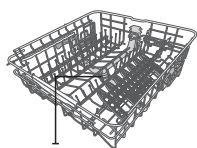
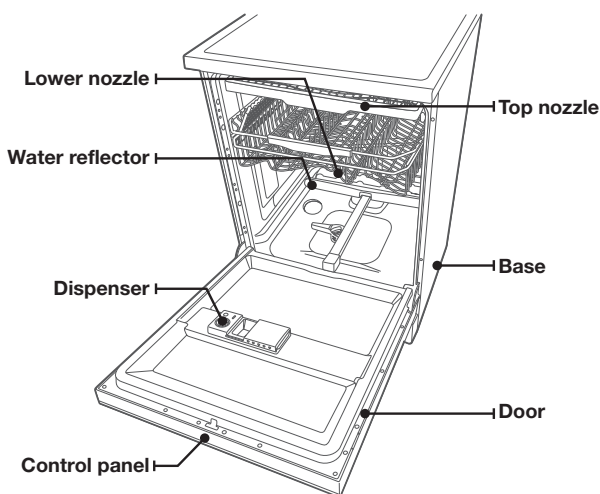

Upper nozzle
Upper rack

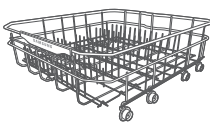

Lower rack



3rd rack



3rd rack PAD

 **Accessory parts** - User Manual, Warranty card, Holder Drain Hose, 3rd Rack PAD.



 **Linear Motion Part** - Belt operating AC motor (Motor Geared), Rail, Belt V-Timing, Holder rail (Front up, Front Low)

DW60H9970** Series

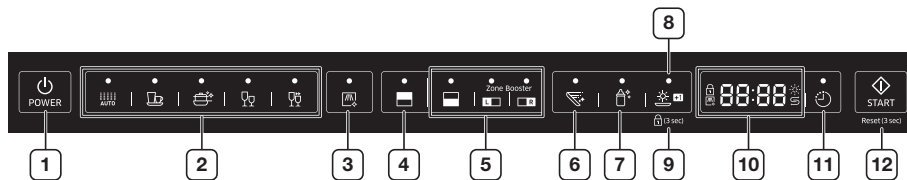





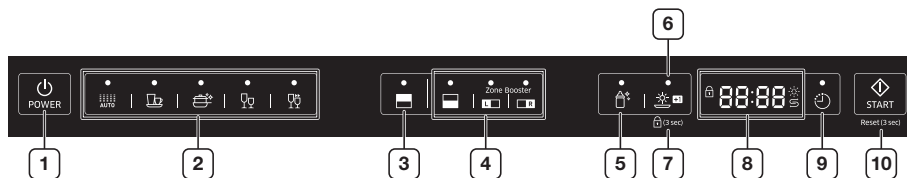

1	Power Button	7	Sanitize Button
2	Cycle Selection Buttons (Auto, Normal, Intensive, Delicate, Quick)	8	Dry+ Button
3	Self Clean Button	9	Child Lock
4	Upper Button	10	Display
5	Lower (Zone Booster) Selection Buttons	11	Delay Start Button
6	Speed Booster Button	12	Start (Reset) Button





DW60H9950** Series



1	Power Button	6	Dry+ Button
2	Cycle Selection Buttons (Auto, Normal, Intensive, Delicate, Quick)	7	Child Lock
3	Upper Button	8	Display
4	Lower (Zone Booster) Selection Buttons	9	Delay Start Button
5	Sanitize Button	10	Start (Reset) Button



Setting up your dishwasher

<p>1 Power</p>	<p>When you press the Power button, the light of the most recently finished cycle turns on. When the cycle you selected has finished, all other indicator lights are turned off and the “End” light is illuminated for some minutes. Then, the Power turns off automatically.</p>
<p>2 Cycle Selector</p>	<p>Select the appropriate wash cycle depending on the soil level of your dishes. After you select a cycle, the Cycle On light for that cycle lights. Also, the Upper and Lower zone lights turn on by default.</p> <p> If you want to change the cycle once it has started, press the Reset button and turn off the dishwasher. Then, turn on the dishwasher again and select a new cycle.</p> <p> Default cycle is Normal.</p>
<p>3 Self Clean (for some models)</p>	<p>Select this option to clean the dishwasher TUB. Run with the dishwasher empty. The Upper and Lower options are turned off by default.</p>
<p>4 Upper (for some models)</p>	<p>When you select Upper, only the upper rack nozzle is activated. The lower nozzle will not operate.</p> <p>Use this feature to wash a small load of dishes or glasses placed in the upper rack.</p> <p> When you select Upper, place dishes, glasses, etc. in the upper rack only. The dishwasher will not wash items placed in the lower rack.</p> <p>Selecting Upper reduces both the cycle time and the amount of electricity consumed.</p>
<p>5 Lower (for some models) / Lower Rack - Only (for some models)</p>	<p>When you select Lower (Lower Rack - Only), only the lower rack nozzle is activated. The upper nozzle will not operate.</p> <p>Use this feature to wash a small load of dishes or glasses placed in the lower rack.</p> <p> When you select Lower (Lower Rack - Only), place items, glasses, etc. in the lower rack only. The dishwasher will not wash items placed in the upper rack.</p> <p>Selecting Lower (Lower Rack - Only) reduces both the cycle time and the amount of electricity consumed.</p> <p> If you want to wash heavily soiled items such as pots and pans, select the Zone Booster option. (This option consumes slightly more water and energy.)</p> <p>Select Zone Booster L option: Applies intensive washing power to the left part of the lower rack.</p> <p>Select Zone Booster R option: Applies intensive washing power to the right part of the lower rack.</p> <p>Select both Zone Booster L & R options: Applies intensive washing power to the whole lower rack.</p> <p> Selecting a Zone Booster option does not turn off the Upper Nozzle.</p>
<p>6 Speed Booster (for some models)</p>	<p>Select this option to wash with short cycle time. (Auto, Normal, Intensive.)</p>

<p>7 Sanitize</p>	<p>With the Sanitize option selected, the water temperature is increased to 70 °C for high temperature sanitization.</p> <p> You cannot select the Sanitize option if you select the Delicate and Quick cycle.</p>
<p>8 Dry+ (Child Lock)</p>	<p>Use this option when you want to dry your dishes more completely. The temperature rises to 65 °C in the final rinse cycle and dry time is increased. If you select the this option, electricity consumption is increased.</p> <p>*Child Lock : This option allows you to lock the buttons on the control panel - except the Power button - so children cannot accidentally start the dishwasher by pressing the buttons on the panel. Only the Power button remains active. To lock or unlock the buttons on the control panel, press and hold the Dry+ (Child Lock) button for three (3) seconds.</p> <ul style="list-style-type: none"> • When the Power is On : Press and hold the “Dry+ (Child Lock)” button for three (3) seconds. • When the Power is Off : Push the Power button first, and then press and hold the “Dry+ (Child Lock)” button for three (3) seconds. • Child Lock remains active until you turn it off. You cannot select cycles or options or start the dishwasher when Child Lock is on.
<p>9 Display</p>	<p>Displays cycle time and remaining hours and minutes, Delay Start hours, and Error messages.</p> <p>If an error occurs during an operation, an error message is displayed with a warning sound.</p> <p>Refer to the “Troubleshooting and information codes” section on page 31.</p> <p> Child Lock indicator</p> <ul style="list-style-type: none"> - Turns on if the Child Lock is set (or the dishwasher is in the standby or pause modes). - Turns off while the dishwasher is operating. - When Child Lock is on, the Child Lock indicator blinks for several seconds if any button except the Power button is pressed. <p> Self Clean indicator (for some models)</p> <ul style="list-style-type: none"> - Turns on when the Self Clean option is enabled (or the dishwasher is in the standby or pause modes), but turns off while the dishwasher is operating. - Blinks for 5 seconds every 20 to 22 cycles. - The cycle counter disappears when the Self Clean operation is complete or when the dishwasher reaches the 23rd cycle without the Self Clean cycle being used. (The Reset or Self Clean operation is not counted by the cycle counter.) <p> Rinse Refill indicator</p> <ul style="list-style-type: none"> - Turns on if the dishwasher runs out of rinse aid (or the dishwasher is in the standby or pause modes). - Turns off while the dishwasher is operating.

Setting up your dishwasher

10 Delay Start	Delay a cycle for up to 24 hours in one-hour increments. To increase the delay start time, press or hold the Delay Start button. The hour displayed indicates the time at which the wash will be started. <ul style="list-style-type: none">- After setting the delay time, press the Start button, and then close the door to start the cycle.- If you want to change the delay time once the dishwasher has started, press the Reset button and turn off the dishwasher. Then, turn on the dishwasher again and select a new cycle with a new delay setting.
11 Start	To start a cycle, press the Start button before closing the door. *Reset : To cancel a currently running cycle and drain the dishwasher, press and hold the Start button for three (3) seconds. Once the dishwasher is reset, select a cycle and option, and then press Start to restart the dishwasher.

-  You can select options (Self Clean, Upper, Lower, Speed Booster, Sanitize, Dry+, Delay Start) before starting a cycle. If you change the cycle after selecting an option, the original cycle is reset.
-  To prevent the touchpad from losing response sensitivity, follow these instructions:
 - Touch the center of each keypad using one finger. Do not push.
 - Clean the touch control's surface regularly with a soft, damp cloth.
 - Be careful not to touch more than one touch key pad at a time, except as directed.

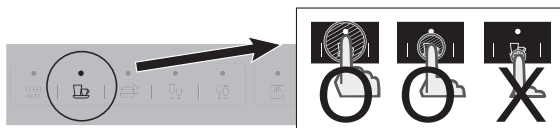

CYCLE SELECTOR

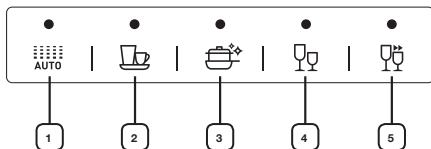

1	Auto	Light to heavily soiled daily used items, automatic detection of the amount of soils.
2	Normal	Normally soiled daily used items, with reduced energy and water consumption. * The Speed Booster option will reduce the cycle time.
3	Intensive	Heavily soiled items include pots and pans.
4	Delicate	Lightly soiled delicate items. You cannot select the Speed Booster , Zone Booster or Sanitize option if you select this cycle.
5	Quick	Lightly soiled with very short cycle time. You cannot select the Speed Booster , Zone Booster or Sanitize option if you select this cycle.

PROGRESS DISPLAYS

DW60H9970 series only



1	Wash		When the dishwasher is in a wash portion of a cycle, the first arrow light is illuminated and the remaining time is displayed.
2	Rinse		When the dishwasher is in a rinse portion of a cycle, the second arrow light is illuminated and the remaining time is displayed.
3	Dry		When the dishwasher is in a drying portion of a cycle, the third arrow light is illuminated and the remaining time is displayed.
4	Clean		After the dishwasher has completed all portions of a cycle, all other indicator lights are turned off. The dishwasher chimes and " End " is displayed for several minutes.

When the dishwasher starts a cycle, the light that corresponds to the current operation turns on to show the progress of the cycle.

Setting up your dishwasher

MEETING THE INSTALLATION REQUIREMENTS

Power supply and grounding



Do not use an extension cord.

WARNING Only use the power cord that came with the dishwasher.

When preparing for the installation, ensure that your power supply offers:

- An AC 220-240 V / 50 Hz fuse or a circuit breaker.
- An individual branch circuit serving your dishwasher.

Your dishwasher must be grounded. If your dishwasher malfunctions or breaks down, grounding will reduce the risk of electric shock by providing a path of least resistance for the electric current.

Your dishwasher comes with a power cord and a grounded, three-prong plug that can be inserted into a properly installed and grounded outlet.



Do not connect the ground wire to a plastic plumbing line, gas line, or hot water pipe.

WARNING

Improperly connecting the grounding conductor can result in electric shock.

Check with a qualified electrician or technician if you are unsure whether your dishwasher has been properly grounded.



Do not modify the plug provided with the dishwasher. If it does not fit the outlet, have a proper outlet installed by a qualified electrician.

CAUTION

Water supply



Do not drink the water from inside the dishwasher.

WARNING

- The dishwasher may be connected to a cold or hot water supply, max 60 °C.
- A stopcock with a 3/4" male thread must be provided on tap.
- The water pressure must be between 0.05 MPa and 0.8 MPa. If the water pressure is too low, the water supply valve may not operate properly causing the dishwasher to turn off. If the water pressure is too high, a pressure reducer valve must be fitted.



You can reduce the risk of leaks and water damage by:

CAUTION

- Making water taps easily accessible.
- Turning off the taps when the dishwasher is not in use.
- Periodically checking the fittings for leaks.

Using Aqua-Stop

The Aqua-Stop was invented as the perfect leakage protection system. It is attached to the water supply hose and automatically cuts off the water flow in the event of damage to the hose.



Aqua-Stop is an electrical component.

- Take care that you do not damage the Aqua-Stop.
- Do not twist or bend the water supply hose connected to the Aqua-Stop.



If the Aqua-Stop has been damaged, shut off the water taps and pull out the power plug right away. Once these steps have been taken, contact Samsung Customer Service or a qualified technician.

Drain

If you are using a drain exclusively for the dishwasher, connect the drain hose to a drain that is between 30 cm to 70 cm off the ground.

Connecting the drain hose to a drain more than 80 cm off the ground can result the water in the dishwasher flowing back or draining incompletely.

Flooring

For best performance, your dishwasher must be installed on a solid, even floor.

Wooden floors may need to be reinforced to minimize vibrations. Carpeting and soft tiles are contributing factors to vibrations and may cause your dishwasher to move slightly while operating.



Never install your dishwasher on a platform or poorly supported structure.

Ambient temperature

Do not install your dishwasher in an area exposed to freezing temperatures. Your dishwasher always retains some water in the water valve, pump and hose and if the water freezes in the machine or hoses, it may damage the appliance and its components.

Test run

Make sure that you install your dishwasher correctly by running the **Quick** cycle after the installation is complete.

Setting up your dishwasher

INSTALLING YOUR DISHWASHER (ONLY FOR INSTALLING UNDER THE SINK)

STEP1. Leveling the dishwasher

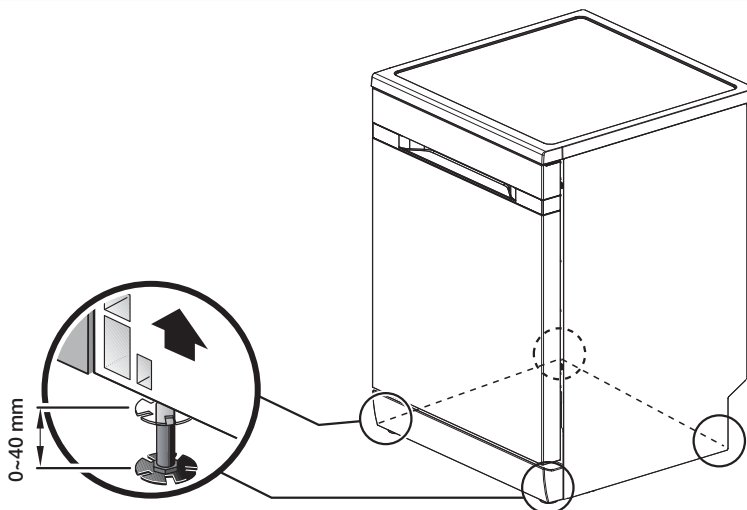

1. You can adjust the height of the product by turning the legs.
 - Slightly lift up the front and back of the product and turn the legs to adjust the height.
 - You can adjust the height up to 40 mm.
2. Push the product into the space under the sink and make sure that the product is level using the leveler.
 - Take care that the hoses or power cord is not twisted. when you push the product into the space under the sink.
3. Install the product so that there is a space of at least 4 mm between the top of the product and the bottom of the top plate of the sink.



After the installation, do not bind the power cord with a cable tie that has a metal wire in it.

STEP2. Connecting the hoses and powering

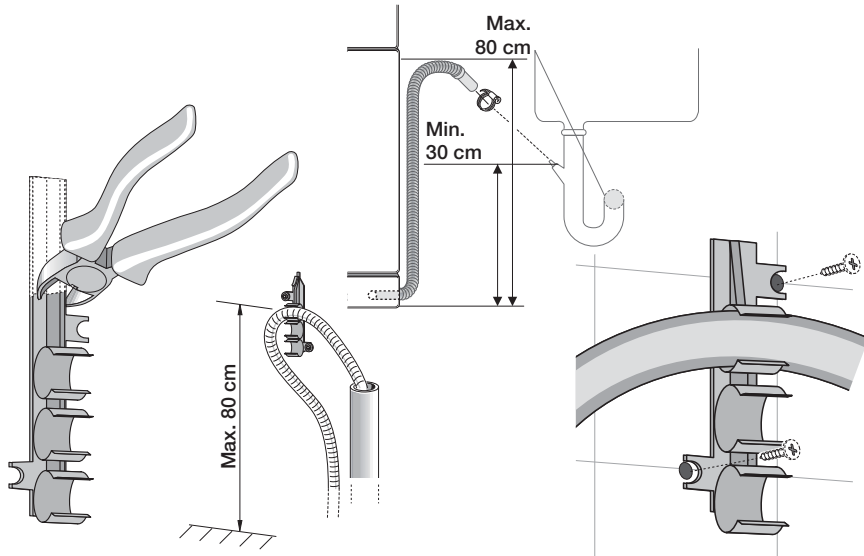

1. Remove the hose holder which is attached to the product and cut off part of the holder as shown in the figure.
2. Discard the part you have just cut off and use only the part that is shown by the figure.
3. Fix it to the wall by fastening the 2 screws.
4. Insert the drain hose into the fixed hose holder. Install the drain hose so that it is placed within a range of 30 cm to 80 cm from the bottom.
5. Connect the drain hose to the drain outlet.



- Take care when you connect the drain hose that it does not move during a draining cycle.
- Confirm that no parts of the drain hose, supply hose or power cord are bent or folded.

6. Open the door and remove all foam, paper packaging, and unnecessary parts.
7. Turn on the circuit breaker you turned off before you began the installation.
8. Open the water supply valve to supply water to the dishwasher.
9. Turn on the dishwasher, and then select and run a cycle.



- Check if the power turns on correctly and if there is any water leakage while the dishwasher is operating. If no errors occur while it is operating, turn off the dishwasher, and then go to No.5 of above.

If an error has occurred, turn off the dishwasher, close the water supply valve, and then refer to the user manual or contact a service centre as referring to the contact list on the back cover.



- Make sure to check for water leakage on both ends of the water supply line and drain hose connector.



Test run

- Make sure that you install your dishwasher correctly by running the **Quick** cycle after the installation is complete.

Before using the product for the first time

SETTING MODE

Turn on the dishwasher, and hold down both the **Sanitize** and **Delay Start** buttons for 3 seconds to enter Settings mode.

Pressing the **Sanitize** button changes the mode in this sequence:

Vane cleaning mode → Sound settings mode → Brightness mode (for some models) → Auto Door mode.

Sound settings mode

Press the **Sanitize** button until “S on” or “SoFF” is displayed. To change the setting, press the **Delay Start** button. “SoFF” means that the sound is off for all cycles.

This setting is continue before changing again.

Brightness mode (Pocket LED brightness setting)

Press the **Sanitize** button until “B0 ~ B5” is displayed. (The higher numbers is more bright). To change setting press **Delay Start** button. (for some models)

Auto Door mode

The door opens automatically when the cycle is complete to improve drying performance.

The door opens immediately before a cycle finishes, and “END” will appear on the display 30 seconds after that.

Press the **Sanitize** button to enter Auto Door mode. (“AOn” on the display indicates Auto Door mode.)

Press the **Delay Start** button to enable or disable the Auto Door.

- **AOn** : Auto Door enabled.
- **AOff** : Auto Door disabled.

* Note that Auto Door will stay active throughout the **ECO** cycle with no option enabled.

* Once the door opens in Auto Door mode, the door cannot be closed manually for the next 2 minutes.

* Auto Door will be disabled for the **Quick** cycle.



-  Changing “Auto Door mode” setting can influence drying result.
Select “AOn” mode for better drying result.

USING DETERGENT

All dishwasher cycles require detergent in the detergent compartment.

Add the correct amount of detergent for the selected cycle to ensure the best performance.



Use dishwasher detergent only. Regular detergent produces too much foam, which may decrease the dishwasher's performance or cause it to malfunction.



Do not swallow dishwasher detergent. Avoid breathing in the fumes. Dishwasher detergent contains irritants and caustic chemicals that can induce respiratory conditions. If you have swallowed dishwasher detergent or inhaled the fumes, seek medical attention immediately.



Keep dishwasher detergent out of the reach of children.

Filling the detergent dispenser

1. Open the detergent dispenser flap by pushing the detergent dispenser release catch.



The flap is always open at the end of a dishwashing cycle.

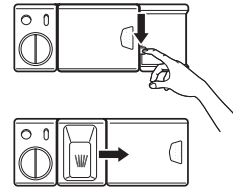

2. Add the recommended amount of detergent to the main wash detergent compartment.

3. Close the flap by sliding it to the left and then pressing it down.



There is no separate button that is specific to using tablet detergents.

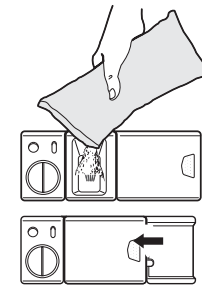

4. For better cleaning result, especially if you have very dirt items, add small amount (about 8 g) of detergent on the door. That will act in prewash phase.

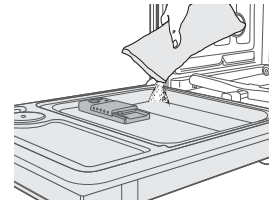

Loading your dishwasher

DISHWASHING GUIDELINES

Follow these simple guidelines to get the best results and save energy.

Before loading dishes





Remove food remains such as bones, fruit seeds, etc. and waste such as toothpicks, paper napkins, etc. from your dishes. Food remains and waste can damage your dishes, make noise and even result in a product malfunction.



Do not wash items that are covered with ash, sand, wax, lubricating grease or paint. These materials will damage the dishwasher and ash does not dissolve and will distribute in hole interior.

Items not suitable for the dishwasher

- **Copper, brass, tin, ivory and aluminium items or with an adhesive**
 - **Non-heat resistant plastics**
 - **Craft items, antiques, valuable vases and decorative glassware**
 - **Colours painted over a glaze**
 - **Wooden cutlery and crockery or items with wooden parts**
 - **Delicate glassware, or glassware containing lead crystal**
 -  Silverware that has been in contact with foods containing sulphur can become discoloured. These include egg yolks, onions, mayonnaise, mustard, fish, fish brine and marinades.
 - Clouding may occur on glasses after frequent washing. Do not wash delicate glassware, or glassware containing lead crystal in the dishwasher.
-  **WARNING** Aluminium components (e.g. grease filters) must not be cleaned with caustic, alkaline cleaning agents. These may damage the material, or in extreme cases, cause a severe chemical reaction. Use only items e. g. glasses, porcelain and cutlery which the manufacturer declare as dishwasher-proof.

ADJUSTING THE HEIGHT OF THE UPPER RACK

You can adjust the height of the upper rack in your Samsung dishwasher so that the lower rack can accommodate larger sized dishes. Depending on where you set the upper rack height, the lower rack can accommodate plates up to 12 in. (30 cm) in diameter and the upper rack can accommodate plates up to 8 in. (20 cm) in diameter.

1. To lower the upper rack by 2 in. (5 cm), pull the adjust handles located at the left and right sides of the upper rack, and then push the upper rack downwards slightly at the same time.
2. To raise the upper rack, just pull the upper rack upwards. The adjuster handle will latch and the upper rack will move to the high position.



We recommend adjusting the height of the upper rack before loading dishes into the rack. If you adjust the the rack after loading the dishes, you may damage the dishes. If you do not adjust with left and right handle together, the dishwasher door may not close properly.

Pull out the upper rack from the tub until it is fully revealed before adjusting the upper rack.

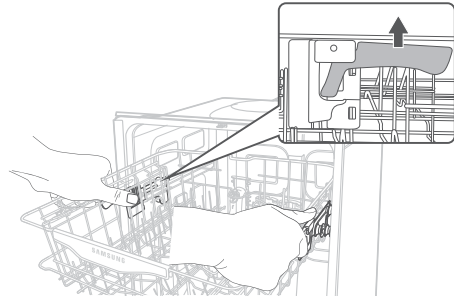

Loading your dishwasher

REMOVING THE UPPER RACK

 You can remove the upper rack to accommodate extra large items in the bottom rack. Take care that you do not lose the holder rails during this process.

To remove the upper rack from the slide rail, pull the upper rack out from the tub until it is fully extended. Hold down the holder rails on both sides to release the upper rack. Slide the upper rack out to the end of one holder rail, and then lift it up.

Repeat the steps above with the other holder rail.

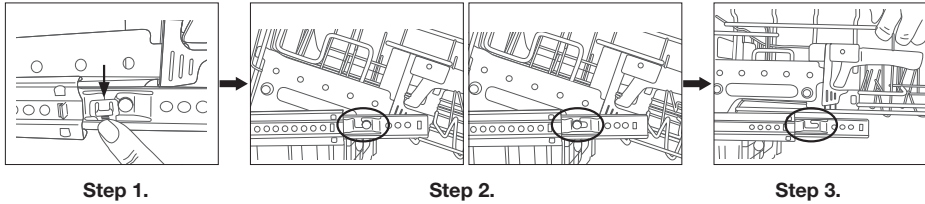

LOADING THE LOWER RACK

Load cookware (pots, pans, etc.), up to 12 in. (30 cm) in diameter into the lower rack. The lower rack has been especially designed for dinner dishes, soup bowls, plates, pots, lids, and casserole dishes. We recommend loading cups, stemware, and small plates into the upper rack. See the recommended loading patterns below.

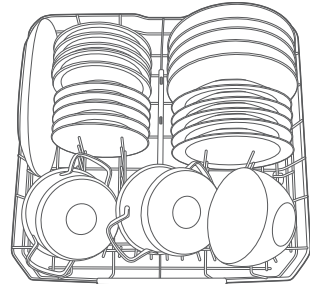

Loading large items into the zone booster areas

You can load large items such as pots and pans into the left and/or right sides of the lower rack - the Zone Booster areas - for more effective cleaning. When you select the Zone Booster option, an additional, powerful jet is activated and directed at items in the Zone Booster areas. Make sure pot handles and other items do not interfere with the rotation of the nozzles and the water reflector.

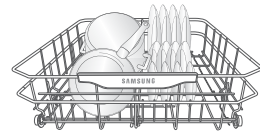

LOADING THE UPPER RACK

The upper rack has been designed for small plates, mugs, glasses, and plastic items marked "dishwasher safe". Load your plates into the dishwasher so that their top sides face each other.

Make sure the loaded dishes do not interfere with the rotation of the nozzle which is located at the bottom of the upper rack. (Check this by rotating the nozzle by hand.)

When loading dishes, pull the upper rack out sufficiently so you can load it without striking the counter above.

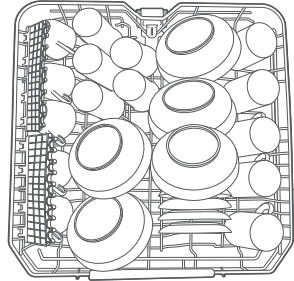

Using the glass support

You can place cups, small items and long cooking utensils on the cup selves. This is also a very convenient way to wash wine glasses.

Place wine glasses on the pegs of the cup selves. The cup selves can also be folded back when not in use.

 Do not adjust the level of the upper basket with the glass supports propped up. This will make it impossible to push in the upper basket.

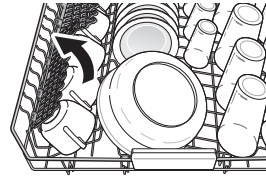

Loading your dishwasher

USING THE 3RD (CUTLERY) RACK (FOR SOME MODELS)

Loading the cutlery rack

In addition to the standard cutlery basket in the lower rack, some models come with a cutlery rack.

The cutlery rack is best suited for flatware and cooking or serving utensils. You can place cutlery and utensils on the cutlery rack.



Removing the Cutlery Rack

The entire cutlery rack can be removed if more space is needed on the upper rack for larger items.

Loading the cutlery pad

Some models come with a removable, foldable cutlery pad along with a cutlery rack. To use, place the pad on the cutlery rack, and then place cutlery and serving and cooking utensils on the pad in a random or regular fashion. After a wash cycle is complete, and the cutlery and utensils are dry, you can fold the pad and carry the cutlery and utensils in the pad to their storage locations.

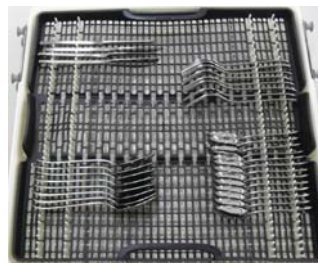

Use caution when folding and moving the rack with a long thin item inside the pad.

The item may fall out in this process, causing physical injury.



It is advisable not to move the pad while it is wet.

Wait until the pad is dry.

The pad dries quickly after a wash cycle when exposed to air for a few minutes.

* When loading the cutlery and utensils onto the cutlery rack, make sure they do not interfere with the top nozzle of the rack. If they interfere, remove the cutlery pad and try again.



USING RINSE AID

Filling the rinse aid reservoir

When the Rinse Refill indicator lights up on the control panel, refill with rinse aid.

Your dishwasher has been designed to use liquid rinse aid only.

Using a powdered rinse aid will clog the reservoir opening and cause the dishwasher to malfunction.

Rinse aid improves the drying performance of the dishwasher.



Do not add regular detergent to the rinse aid reservoir.

1. Remove the rinse aid reservoir cap by rotating it counterclockwise.



Adding rinse aid to tablet detergents will improve drying performance.

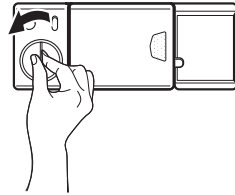

2. Fill the rinse aid reservoir with rinse aid.



Use the viewing port when filling the rinse aid reservoir.



Do not fill the reservoir above the full level indicator.

Excess rinse aid can overflow during the wash cycle.

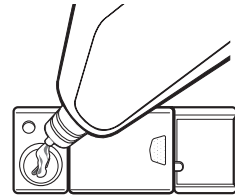

3. Turn the rinse aid indicator dial to a number between 1 and 6. The higher the number, the more rinse aid the dishwasher uses. If you are unable to rotate the rinse aid dial easily, try using a coin.

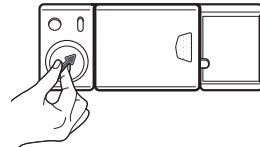

4. Close the rinse aid reservoir cap by rotating it clockwise.

Cleaning and maintaining your dishwasher

Keeping your dishwasher clean improves its performance, reduces unnecessary repairs, and prolongs its life.

CLEANING THE EXTERIOR

It's best to clean spills on the exterior of your dishwasher as they occur.

Use a soft, damp piece of cloth to gently wipe away spills and dust from the control panel.



Do not use benzene, wax, thinner, chlorine bleach, or alcohol. These chemicals may discolour the inner walls of the dishwasher and cause stains.



Do not clean the dishwasher by sprinkling water over it. In particular, protect the electrical components from coming into contact with water.



If your dishwasher has a stainless steel door panel, it can be cleaned with a stainless steel cleaner for Home Appliances or similar product using a clean, soft cloth.

CLEANING THE WASH CABINET

If there are limescale or grease deposits in the cabinet, remove these by damp cloth or run a programme which has highest rinsing temperature without any loading items after filling detergent dispenser with dishwasher detergent.



Do not remove the front seal on the container. Removing the seal can cause the dishwasher to leak or malfunction.

CLEANING THE FILTERS

1. Turn off the dishwasher.
2. Rotate the filter insert counterclockwise to unfasten and then detach the filter insert.

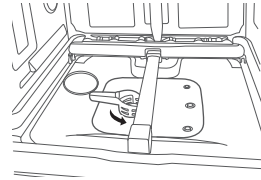

3. Remove the fine filter (flat rectangular).

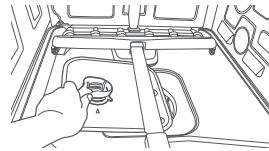

4. Disassemble the coarse filter and micro filter.

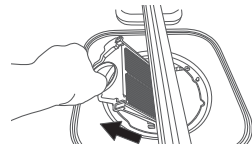

5. Remove any dirt or other remains from the filters and rinse them under running water.

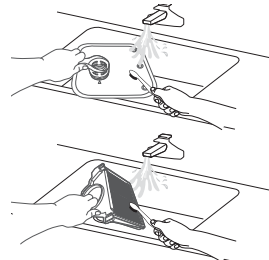

6. Reassemble the filters in the reverse order of the disassembly, replace the filter insert, and rotate clockwise to the close arrow.



If the filter insert is not closed properly, the performance will be decreased.

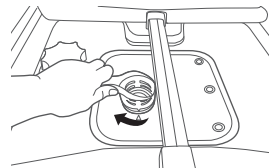

Cleaning and maintaining your dishwasher

CLEANING THE NOZZLES

If your dishwasher does not seem to be cleaning adequately or the nozzles seem clogged, you can clean each of the nozzles. When removing the nozzles, take care as they may break.

Upper nozzle

1. Pull the upper rack towards the front.
2. Check whether the nozzle holes are clogged by food particles.
3. If cleaning is needed, remove the nozzle.
4. To remove the nozzle, unfasten and remove the nut, and then remove the nozzle.
5. Clean the nozzle, re-insert it, and fasten the nut.
6. When fastening the nut, turn it firmly by hand.
7. Check whether the nozzle is engaged correctly by rotating it by hand.

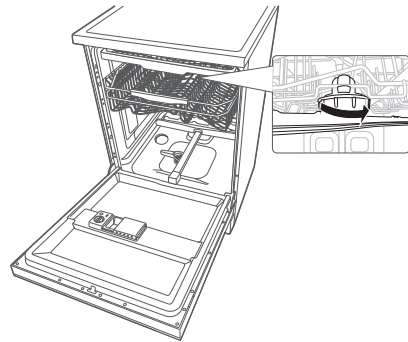

Top nozzle

1. Check whether the nozzle holes are clogged by food particles.
2. If cleaning is needed, remove the nozzle.
3. To remove the nozzle, pull out the upper rack first, unfasten the nozzle cap by turning it counterclockwise, and then remove the upper nozzle.
4. Clean the nozzle, re-insert it, and then fasten the nozzle cap to the nozzle by turning the cap clockwise.
5. Check whether the nozzle is engaged correctly by rotating it by hand.

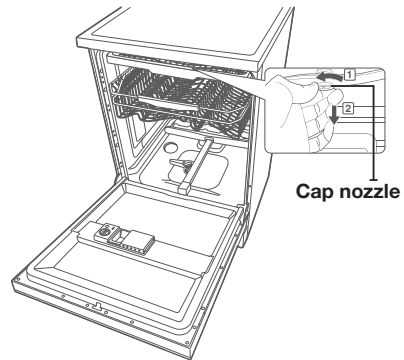





STORING YOUR DISHWASHER

If you need to store your dishwasher for an extended period of time, first drain the unit fully and then disconnect the water hose.

Your dishwasher can become damaged if water is left in the hoses and internal components before storing it. After draining and disconnecting the dishwasher, be sure to turn off the water supply valve and circuit breaker.

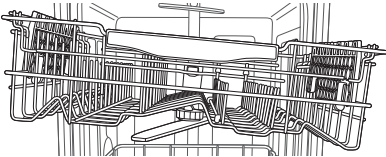
Troubleshooting and information codes

CHECK THESE POINTS IF YOUR DISHWASHER...

PROBLEM	POSSIBLE CAUSE	SOLUTION
Will not start.	The door is not closed completely.	<p>Check if the door is latched and closed completely. Check whether the Upper Rack is properly joined with Duct Nozzle.</p> <p>Also, Check imbalance assembly of the Upper Rack.</p> 
	The Start (Reset)  button is not selected.	Check that the door is latched and closed completely. Press the Start (Reset)  button before closing the door.
	No programme is selected.	Select a programme.
	The power cord is not connected.	Connect the power cord.
	There is no water supplied.	Check that the water supply valve is open.
	The control panel is locked.	Deactivate the Child Lock function to unlock the control panel.
Has a bad odour.	There is water left over from the last cycle.	Add detergent without loading dishes and run the Self Clean  programme to clean the dishwasher.
Has water remaining after the programme has finished.	The drain hose is folded or clogged.	Straighten and unclog the hose.

Troubleshooting and information codes

PROBLEM	POSSIBLE CAUSE	SOLUTION
Has food particles remaining on the dishes.	An inappropriate programme was selected.	Select a programme according to the soil level of the dishes as directed in this manual.
	The filter is contaminated or not correctly fasten.	Clean the filter and make sure the filters are fitted properly.
	No dishwasher detergent or not enough detergent is being used.	Use an automatic dishwasher detergent or use more detergent.
	The pressure of the supplied water is low.	The water supply pressure must be between 0.05 MPa and 0.8 MPa.
	Spray arm jets are clogged.	Clean the spray arms.
	The dishes are improperly loaded.	Rearrange the dishes so they have good water access and do not interfere with spray arm and dispenser operation.
	The water is too hard.	Check salt refill indicator and refill dishwasher salt.
Does not dry dishes well.	There is no rinse aid in the dispenser or not enough rinse aid was used.	Check the dispenser and add rinse aid. Check rinse aid setting.
	Multi taps were used without selecting the Dry+ function.	Select the Dry+ function or use rinse aid.
	Glasses and cups with concave bottoms hold water. This water may spill onto other items when you are unloading.	After finishing the cycle, empty the lower rack first and then the upper, this will avoid water dripping from the upper rack onto the dishes in the lower rack.
Is too noisy.	The dishwasher beeps when the dispenser cover is opened and during the initial stage of draining the pump operation.	This is a normal operation.
	The dishwasher is not level.	Ensure that the dishwasher is level.
	There is a 'chopping' sound because an arm is bumping against the dishes.	Rearrange the dishes.
Leaves a yellow or brown film on cups or dishes	This can occurs from coffee and tea soils.	Use programme with higher temperature.
Does not have any indicators lit.	The power cord is not connected.	Connect the power cord.
Does not have smoothly rotating arms.	The arms are clogged with food particles.	Clean the arms.
Leaves a white coating on cutlery or crockery after cleaning.	Hard water was used.	Check the salt fill indicator and softener setting is correct according to the water hardness of your area. Check salt reservoir cap is correctly fitted.

INFORMATION CODES

The Control Panel displays information codes to help you understand what is occurring with your dishwasher. If you see any of the codes listed below, you should select the **Reset** option, and then follow the instructions in the Solution column.



CODE SYMBOL	MEANING	SOLUTION
tE	Temperature sensor error	Functional error. With the dishwasher empty, add detergent, and then run a cycle. If the problem continues, go to your house circuit breaker panel, set the dishwasher's circuit breaker switch to off, and then contact an authorized Samsung service center.
HE1	Heater error	
HE	High temperature heating error	
1E	Low water level error	
PE	Half load function error	
7E	Reflector function error	Check if flatware or dishware interferes with the water reflector and the water reflector does not operate as a result. If this happens without any interference, close the water supply valve and contact an authorized Samsung service center.
4E	Water supply error	Check whether the water supply valve is closed, the water supply is suspended, or the water inlet valve or line is frozen or clogged by foreign particles. If the problem continues, close the water supply valve, and then contact an authorized Samsung service center.
4E5		
5E	Drain error	Check whether the drain hose is clogged or folded. If the problem continues, close the water supply valve, and then contact an authorized Samsung service center.
OE	Over-level water error	Functional error. Close the water supply valve and go to your house circuit breaker panel, set the dishwasher's circuit breaker switch to off, and then contact an authorized Samsung service center.
LE	Leakage	
bE2	Button error	Functional error. Turn off the dishwasher and try to start it again. If the problem continues, contact an authorized Samsung service center.
3E	Communication error	
AE		
bE3		
AE6		
dE3	Auto door open error	This error occurs if the door doesn't open automatically during the dry cycle. If the problem continues, close the water supply valve, and then contact an authorized Samsung service center.

For any codes not listed above, call 1-800-SAMSUNG (726-7864)

Programme chart

PROGRAMME CHART

Soil level	Auto	Normal	Intensive	Delicate	Quick
Amount of food remains	Very light to Heavy	Normal	Heavy	Light	Light
Program sequence	Prewash ▶ Mainwash ▶ Rinse ▶ Hot rinse ▶ Dry ▶ End	Prewash ▶ Mainwash ▶ Rinse ▶ Hot rinse ▶ Dry ▶ End	Prewash ▶ Mainwash ▶ Rinse ▶ Hot rinse ▶ Dry ▶ End	Prewash ▶ Mainwash ▶ Rinse ▶ Hot rinse ▶ Dry ▶ End	Mainwash ▶ Rinse ▶ Hot rinse ▶ End
Water consumption (L)	11.0-21.0	12.2	25.9	10.9	11.2

-  The wash time varies depending on the options you add, and on the pressure and temperature of the supplied water.
-  Quick Cycle : This cycle doesn't work AUTO DOOR. (without DRY course)
-  The power consumption depends on the water temperature and/or load.
When the Rinse Aid is empty, time and temperature can increase a little.
The water consumption and wash time depending on the steps or options you add, and on the pressure and temperature of the supplied water.

Appendix

DISPOSING THE DISHWASHER AND HELPING THE ENVIRONMENT

Your dishwasher is manufactured from recyclable materials. If you decide to dispose of it, please observe your local waste disposal regulations. Cut off the power cord so that the appliance cannot be connected to a power source.

Remove the door so that animals and children cannot get trapped inside the appliance.

Do not exceed the detergent quantities recommended in the detergent manufacturers' instructions.

DECLARATION OF CONFORMITY

This product complies with the requirements of these directives:

EMC-Directive 2004/108/EC

Low Voltage Directive 2006/95/EC

SPECIFICATIONS

MODEL	DW60H9970FS	DW60H9950FS DW60H9950FW
Power	AC 220 ~ 240 V / 50 Hz	
Type	Free Standing	
Water pressure	0.05 ~ 0.8 Mpa	
Wash capacity (place settings)	15	
Rated power	2000 ~ 2300 W	
Dimension (mm)	598 (W) x 845 (H) x 600 (D)	
Weight	Unpacked	48.0 kg
	Packed	51.0 kg

For standard test

 The diagrams below show the proper way to load the baskets based on the Australian/New Zealand Standard (AS/NZS 2007.2 & 6400).

- Washing capacity: 15 place settings
- Test standard: AS/NZS 2007.2 & 6400
- Position of upper basket: Low
- Programme: Normal
- Additional options: Upper only + Lower only (Default)
- Rinse aid setting: 6
- Dosage of the standard detergent
 - 15 PS : 8 g + 25 g
- For the arrangement of the items, refer Figure A, B, C.
- Drying condition : Auto Door Open (More than 80 mm)

15 place settings

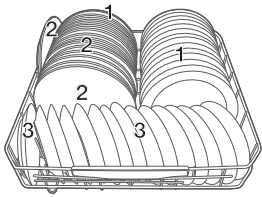
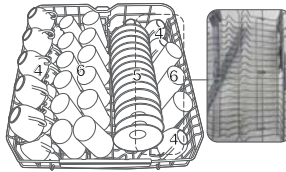
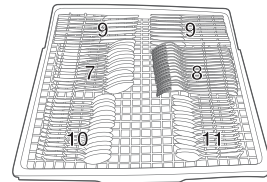

Figure A-1: Lower basket



Place the Wire Folding left side.

Figure B-1: Upper basket



Without 3rd rack pad

Figure C-1: Cutlery tray

1	Soup plate	4	Cup	7	Soup spoon
2	Dinner plate	5	Saucer	8	Fork
3	Dessert dish	6	Glass	9	Knife
				10	Dessert spoon
				11	Tea spoon

Drying condition

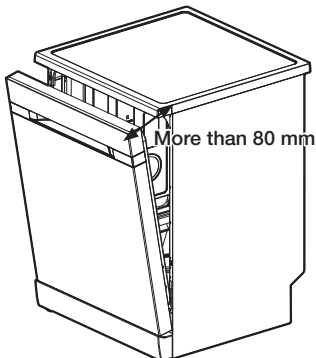

Note

Note

Note



QUESTIONS OR COMMENTS?

COUNTRY	CALL	OR VISIT US ONLINE AT
AUSTRALIA	1300 362 603	www.samsung.com/au/support

DD68-00158E-03