

dynaudioacoustics

Delta series, manufactured by MC2 Audio

DELTA 20

Operating Instructions

Dynaudio A/S

8660 Skanderborg, Denmark

www.dynaudio.com

CONTENTS

DECLARATION OF CONFORMITY	4
THANKS.....	5
INTRODUCTION.....	5
IMPORTANT SAFETY INSTRUCTIONS	6
INSTRUCTIONS DE SECURITE IMPORTANTES	7
Installing Your Amplifier: Electrical Considerations.....	8
Installing Your Amplifier: Mechanical Considerations.....	9
Installing Your Amplifier: RF Emissions	9
About Your Amplifier: Dynamic Amplifier Performance Measurements	10
Connecting To Your Amplifier: Line Inputs and Outputs.....	11
Connecting To Your Amplifier: Speaker Outputs.....	12
Connecting To Your Amplifier: Bridged (Mono) Operation.....	13
Operating Your Amplifier: Front Panel Controls and Indicators.....	14
Operating Your Amplifier: Rear Panel Sockets and Switches	15
Operating Your Amplifier: Initial Set-up and Switching On.....	16
Switching On.....	16
Operating Your Amplifier: Switching between analogue & networked audio	17
Operating Your Amplifier: General Purpose Connections (GPIO) Port	18
Internal Adjustments to Your Amplifier: Fixed fan speed.....	19
Internal Adjustments to Your Amplifier: Auto-standby mode	20
Internal Adjustments To Your Amplifier: Changing the Gain	21
Looking After Your Amplifier: Maintenance	22
Looking After Your Amplifier: Warranty.....	22
Performance Of Your Amplifier: Specifications	23
Performance Of Your Amplifier: Thermal Specifications.....	24
Appendix I: Speaker Backup Inputs.....	25
Appendix II: 70/100V line output operation	26
Appendix III: 70/100V line distributed audio systems	27
Introduction	27
How It Works	27
Example: How many speakers can I connect to an amp channel?.....	28
Getting The Best Performance.....	29
In Conclusion.....	31



DECLARATION OF CONFORMITY

We, the manufacturer:

**XTA Electronics Ltd
(TRADING AS MC² Audio)
Units 6-7 Kingsgate
Heathpark Industrial Estate
Honiton, Devon
England
EX14 1YG**

acknowledge our responsibility and self-certify the following products:

Kind of equipment:	Audio amplifier
Commodity Code:	8518400090
Type Designation:	I38/I68/I64
	Delta40DSP, Delta80DSP, Delta100DSP Delta20ND, Delta40ND, Delta80ND, Delta100ND, Delta120ND
	DPA40, DPA80, DPA100 DNA20, DNA40, DNA80, DNA100, DNA120
	T500, T1000, T2000, T4-250
	Ti500, Ti1000, Ti1500, Ti2000, Ti3500, Ti4-250
	E15, E25, E45, E475
	S800, S1400
	and all OEM/variants of these models

are manufactured in accordance with **EMC Directive 2014/30/EU (CE and UKCA)**, in compliance with the following norm(s) or document(s):

Technical Regulations: EN61000-3-2:2014 (Mains Harmonic)
EN61000-3-3:2013 (Mains Flicker)
EN55032:2015 (Emissions)
EN55032:2017 (Immunity)

and in accordance with the: **Low Voltage Directive 2014/35/EU (CE and UKCA)**
in compliance with the following norm(s) or document(s):

Technical Regulations: EN/IEC62368-1:2020 (Audio, Video & Communication Safety)

and in accordance with the **Directive 2011/65/EU** on the restricted use of certain Hazardous Substances in Electrical and Electronic Equipment (**RoHS2**). We certify that the above-mentioned products are deemed compliant according to the details given in the directive.

Signed:

Name: Alex Cooper
Position: Research and Development Manager
Date: Jan 2024



THANKS

Thank you for choosing a Delta Series amplifier for your application. Please spend a little time reading through this manual, so that you obtain the best possible performance from the unit and become familiar with its operating requirements.

All MC² products are carefully designed and engineered for cutting-edge performance and world-class reliability. If you would like further information about this or any other MC² product, please contact us.

We wish you many years of service from this amplifier and look forward to hearing from you in the near future.

INTRODUCTION

The Delta Series has been designed to combine incredible audio power and performance with ultra-flexible connectivity for both remote control and audio. Exemplary audio processing is assured through the use of XTA's DSP platform in the DSP enabled models, and power amplifier capabilities are taken care of with high efficiency output stages and a generous power supply.

Accepting analogue, *or optional Dante networked audio*, this extra connectivity means that the Delta Series non-DSP models can also be used in installation systems which already have a centralized DSP core but require the flexibility of being able to pick up multiple channels of audio from a network.

With a range of power levels available in the Delta Series, the non-DSP amplifiers can be networked to a single Delta DSP model, creating a powerful, efficient system that's easy to expand and adapt for use in live, install and everything in between.

#powermeetsprocessing

IMPORTANT SAFETY INSTRUCTIONS



CAUTION: RISK OF ELECTRIC SHOCK. DO NOT OPEN



The lightning flash with arrowhead symbol within an equilateral triangle is intended to alert the user to the presence of uninsulated "dangerous voltage" within the product's enclosure that may be of sufficient magnitude to constitute a risk of electric shock to persons.



The exclamation mark within an equilateral triangle is intended to alert the user of important operating and maintenance (servicing) instructions in the literature accompanying the appliance.

WARNING: Apparatus with CLASS I construction shall be connected to a MAINS socket outlet with a protective earthing connection.

WARNING: To prevent injury, this apparatus must be securely attached to the rack in accordance with the installation instructions.

1. Read these instructions.
2. Keep these instructions.
3. Heed all warnings.
4. Follow all instructions.
5. Do not use this apparatus near water.
6. Clean only with a dry cloth.
7. Do not block any ventilation openings, install in accordance with the manufacturer's instructions.
8. Do not install near any heat sources, such as radiators, heat registers, stoves or other apparatus (including amplifiers) that produce heat.
9. Do not defeat the safety purpose of the polarized or grounding-type plug. A polarized plug has two blades with one wider than the other. A grounding-type plug has two blades and a third grounding prong. The wide blade or the third prong are provided for your safety. If the provided plug does not fit into your outlet, consult an electrician for replacement of the obsolete outlet.
10. Protect the power cord from being walked on or pinched particularly at plugs, convenience receptacles and the point where they exit from the apparatus.
11. Only use attachments/accessories specified by the manufacturer.



12. Use only with the cart, tripod, bracket or table specified by the manufacturer, or sold with the apparatus. When a cart is used, use caution when moving the cart/apparatus combination to avoid injury from a tip over.

13. Unplug this apparatus during lightning storms or when unused for a long period of time.
14. Refer all servicing to qualified service personnel. Servicing is required when the apparatus has been damaged in any way, such as if the power-supply cord or plug is damaged, liquid has been spilled or objects have fallen into the apparatus, the apparatus has been exposed to rain or moisture, does not operate normally, or has been dropped.
15. Do not expose this equipment to dripping or splashing and ensure that no objects filled with liquids, such as vases, are placed on the equipment.
16. To completely disconnect this equipment from the AC mains, disconnect the power cord from the mains circuit breaker.
17. This unit is fitted with a 3-wire power cord. For safety reasons, THE EARTH LEAD SHOULD NOT BE DISCONNECTED IN ANY CIRCUMSTANCE.



18. Correct disposal of this product: This symbol indicates that this product must not be disposed of with household waste, according to the WEEE Directive (2012/19/EU) and your national law. This product should be taken to a collection center licensed for the recycling of waste electrical and electronic equipment (EEE). The mishandling of this type of waste could have a possible negative impact on the environment and human health due to potentially hazardous substances that are generally associated with EEE. At the same time, your cooperation in the correct disposal of this product will contribute to the efficient use of natural resources. For more information about where you can take your waste equipment for recycling, please contact your local city office, or your household waste collection service.

INSTRUCTIONS DE SECURITE IMPORTANTES

ATTENTION: RISQUE DE CHOC ELECTRIQUE.
NE PAS OUVRIR

Le symbole représentant un éclair fêché dans un triangle équilatéral a pour but d'alerter l'utilisateur de la présence d'une "tension dangereuse" non isolée à l'intérieur du boîtier, pouvant être d'une force suffisante pour constituer un risque d'électrocution.



Le point d'exclamation dans un triangle équilatéral a pour but d'alerter l'utilisateur de la présence d'instructions importantes concernant le fonctionnement et la maintenance, dans la documentation qui accompagne l'appareil.

ATTENTION: Appareils de construction de CLASSE I doit être raccordé au réseau électrique via une prise de courant reliée à la terre.

ATTENTION: Pour éviter toute blessure, cet appareil doit être solidement fixé à la torture, conformément aux instructions d'installation.

1. Lisez ces consignes.
2. Conservez ces consignes.
3. Respectez tous les avertissements.
4. Respectez toutes les consignes d'utilisation.
5. N'utilisez jamais l'appareil à proximité d'un liquide.
6. Nettoyez l'appareil avec un chiffon sec.
7. Veillez à ne pas empêcher la bonne ventilation de l'appareil via ses ouïes de ventilation. Respectez les consignes du fabricant concernant l'installation de l'appareil.
8. Ne placez pas l'appareil à proximité d'une source de chaleur telle qu'un chauffage, une cuisinière ou tout appareil dégageant de la chaleur (y compris un ampli de puissance).
9. Ne supprimez jamais la sécurité des prises bipolaires ou des prises terre. Les prises bipolaires possèdent deux contacts de largeur différente. Le plus large est le contact de sécurité. Les prises terre possèdent deux contacts plus une mise à la terre servant de sécurité. Si la prise du bloc d'alimentation ou du cordon d'alimentation fourni ne correspond pas à celles de votre installation électrique, faites appel à un électricien pour effectuer le changement de prise.
10. Installez le cordon d'alimentation de telle façon que personne ne puisse marcher dessus et qu'il soit protégé d'arêtes coupantes. Assurez-vous que le cordon d'alimentation est suffisamment protégé, notamment au niveau de sa prise électrique et de l'endroit où il est relié à l'appareil; cela est également valable pour une éventuelle rallonge électrique.
11. Utilisez exclusivement des accessoires et des appareils supplémentaires recommandés par le fabricant.



12. Utilisez exclusivement des chariots, des diables, des présentoirs, des pieds et des surfaces de travail recommandés par le fabricant ou livrés avec le produit. Déplacez précautionneusement tout chariot ou diable chargé pour éviter d'éventuelles blessures en cas de chute.

13. Débranchez l'appareil de la tension secteur en cas d'orage ou si l'appareil reste inutilisé pendant une longue période de temps.
14. Les travaux d'entretien de l'appareil doivent être effectués uniquement par du personnel qualifié. Aucun entretien n'est nécessaire sauf si l'appareil est endommagé de quelque façon que ce soit (dommages sur le cordon d'alimentation ou la prise par exemple), si un liquide ou un objet a pénétré à l'intérieur du châssis, si l'appareil a été exposé à la pluie ou à l'humidité, s'il ne fonctionne pas correctement ou à la suite d'une chute.
15. N'exposez pas cet équipement au fait de tomber goutte à goutte ou au fait d'éclabousser et gardez qu'aucun objet rempli des liquides, comme les vases, n'est placé sur l'équipement.
16. Pour complètement débrancher cet équipement de la conduite principale de courant alternatif, débranchez la corde de pouvoir du disjoncteur de conduite principale.
17. Cette unité est correspondue avec une corde de pouvoir de 3 fils. Pour les raisons de sécurité, L'AVANCE DE TERRE NE DEVRAIT ÊTRE DÉBRANCHÉE DANS AUCUNE CIRCONSTANCE.



18. Mise au rebut appropriée de ce produit: Ce symbole indique qu'en accord avec la directive DEEE [2012/19/EU] et les lois en vigueur dans votre pays, ce produit ne doit pas être jeté avec les déchets ménagers. Ce produit doit être déposé dans un point de collecte agréé pour le recyclage des déchets d'équipements électriques et électroniques (EEE). Une mauvaise manipulation de ce type de déchets pourrait avoir un impact négatif sur l'environnement et la santé à cause des substances potentiellement dangereuses généralement associées à ces équipements. n même temps, votre coopération dans la mise au rebut de ce produit contribuera à l'utilisation efficace des ressources naturelles. Pour plus d'informations sur l'endroit où vous pouvez déposer vos déchets d'équipements pour le recyclage, veuillez contacter votre mairie ou votre centre local de collecte des déchets.

Installing Your Amplifier: Electrical Considerations

The amplifier has been manufactured to comply with your local power supply requirements, but before connecting the unit to the supply, ensure that the voltage (printed on the rear panel) is correct.

The amplifier is fitted with a universal power supply that operates from 90V – 260VAC.

Make sure power outlets conform to the power requirements listed on the back of the unit. Damage caused by connecting to improper AC voltage is not covered by the warranty.

SAFETY WARNING

Where a MAINS plug or appliance coupler is used as the disconnect device, it should remain readily operable.

Where the amplifier is mounted in a rack and permanently connected to the mains, then the rack should be installed with a readily accessible connector or an ALL POLE circuit breaker with 3mm breaking distances.

For use by professionals only.

For safety reasons,

THE EARTH LEAD SHOULD NOT BE DISCONNECTED IN ANY CIRCUMSTANCE.

If ground loops are encountered consult the section on connecting your amplifier on page 11.

The wiring colours are:

230V AREAS: EARTH = GREEN AND YELLOW
NEUTRAL = BLUE
LIVE = BROWN

DO NOT USE THE UNIT IF THE ELECTRICAL POWER CORD IS FRAYED OR BROKEN. The power supply cords should be routed so that they are not likely to be walked on or pinched by items placed upon or against them, paying particular attention to cords and plugs and the point where they exit from the appliance.

ALWAYS OPERATE THE UNIT WITH THE AC GROUND WIRE CONNECTED TO THE ELECTRICAL SYSTEM GROUND. Precautions should be taken so that the means of grounding of a piece of equipment is not defeated.

DO NOT REMOVE THE LID. Removing the lid will expose you to potentially dangerous voltages. There are no user serviceable parts inside.

ESD strikes to the unit's front panel that are in excess of 4000 volts may cause disturbance to the status LEDs on the unit. This will not affect audio performance and will be corrected on the next power up cycle.

Installing Your Amplifier: Mechanical Considerations

To ensure that this equipment performs to specification, it should be mounted in a suitable rack or enclosure as described below. Like all high power amplifiers, it should be kept away from other equipment which is sensitive to magnetic fields. Also, this amplifier may suffer a substantial reduction in performance if it is subjected to, or mounted close to equipment which radiates high radio frequency (RF) fields.

Warning: To prevent injury, this apparatus must be securely attached to the rack in accordance with the installation instructions.

When mounting the amplifier in a rack or enclosure, be aware that...

THE FRONT PANEL IS NOT CAPABLE OF SUPPORTING THE UNIT ON ITS OWN.

Make sure that the rear of the unit is adequately supported. Rear bracket support holes are built into the chassis. Brackets are available as an option.

ENSURE THERE IS ADEQUATE VENTILATION.

The cooling fans suck cool air in through the front and blow hot air out at the rear of the unit through the ventilating grills. The front and rear of the amplifier should have free exposure to the air (i.e. in a rack leave the front & rear doors off), with 2cm air gap at the sides.

IF AIR IS NOT ALLOWED TO ESCAPE FROM THE REAR, OVER-HEATING WILL OCCUR.

Take care when mounting other equipment in the same rack.

Make sure that the rack unit has a separate earth connection (technical earth).

Please also see the notes regarding maintenance on page 17.

Installing Your Amplifier: RF Emissions

The high frequency resonant converters in the Delta Series amplifiers have been designed to have very low RF emissions; however, even these low-level emissions can cause interference with other equipment.

In order for this to be minimised, the amplifier should be mounted in a metal rack enclosure, which should have a separate (technical) Earth. Alternatively, a separate earth should be attached to the amplifier using the rear panel earth point (see page 15).

About Your Amplifier: Dynamic Amplifier Performance Measurements

The Delta Series are the very latest example of a 'dynamic amplifier'. This new 'breed' of power amplifiers provide very high peak power levels in a much smaller, and lighter, package than previously possible with conventional amplifiers.

They are designed specifically for today's high power audio installations, which use multiple speakers with electronic crossovers or speaker controllers. These systems can handle very high transient signals that far exceed their RMS power rating. The Delta Series amplifiers have been designed to match this requirement and can deliver huge levels of power for short durations.

In order to protect themselves and the loudspeakers that they are driving, continuous signals such as sine waves, are automatically detected and reduced (ramped down) to a safe level.

When trying to **measure the power output** however, continuous signals will give totally incorrect results. A dynamic signal, such as a tone burst, should be used and the levels measured by monitoring the waveform on an oscilloscope. The power envelope can then be accurately measured.

Our power output figures are measured using signals with known Crest Factors and are quoted at the rear of this manual on page 23 and on our website.

Please refer to the technical area of our website for further information – here you can download a set of Crest Factor tailored audio samples to allow you to compare our specifications with any other amplifier.

Connecting To Your Amplifier: Line Inputs and Outputs

The inputs are made via 3-pin XLR connectors, which are electronically balanced and should be connected via a high grade twin core screened cable, as follows:

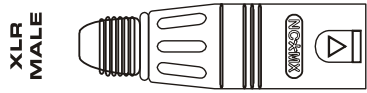

PIN1: Screen (see note below)
PIN2: Hot (signal +)
PIN3: Cold (signal -)

The amplifier is designed to operate with fully balanced equipment and ground loops or loss of performance may be experienced if connected to unbalanced sources. If it is unavoidable however, the following wiring should be used. The cable should still be twin core plus screen.

PIN1: Screen - connected to the chassis of the unbalanced equipment - or left disconnected at the unbalanced end.
PIN2: Hot (signal +)
PIN3: Cold (ground 0V)

NOTE: This amplifier is wired to the latest industry recommendations. PIN1 is connected directly to the chassis/mains earth. If ground loops (mains hum) are encountered remove the screen connection from the other end of the cable and leave it open circuit. If problems persist, consult your dealer/supplier.

DO NOT TAMPER WITH OR ALTER ANY GROUND (EARTH) CONNECTIONS INSIDE THE AMPLIFIER.

For bridged operation input should be made to channel A (or C) only and the channels set for bridged mode for the appropriate pair of channels. Please see page 13 for details of how to do this.

Connecting To Your Amplifier: Speaker Outputs

The speaker outputs are via Neutrik Speakon connectors. 2 pole (NL2FC) or 4 pole (NL4FC) connectors can be used.

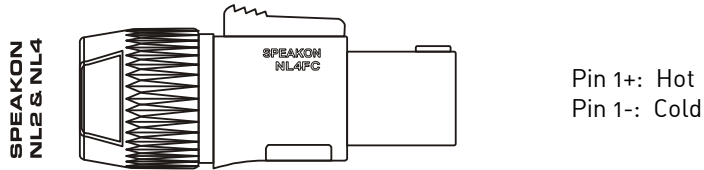

Additionally, Channel 1 Speakon connector carries Channel B2 output on Pins +2 & -2 to allow easy bi-amping or bridged operation using a single NL4 connector. Similarly, Channel 3's Speakon connector also carries Channel 4 output.

Output Connector 1

Pin 2+: Hot Ch. 2

Pin 2-: Cold Ch. 2

Output Connector 3

Pin 2+: Hot Ch. 4

Pin 2-: Cold Ch. 4

For bi-amped operation, connect as above.

As the currents involved are relatively high, and to ensure best performance, the speaker cables should be kept as short as possible and conform to the following minimum requirements:

Delta 20 NON-DSP, 6A into 4 Ohm speaker loads

When operating the amplifier into loads of less than 4 Ohms, be aware that the current capacity of the speaker cables will need to be increased above the values quoted here.

Do not connect the inputs/outputs to any other voltage source such as a battery, mains source or power supply, regardless of whether the amplifier is turned on or off.

Do not run the output of any amplifier channel back into another channel's input and do not parallel or series-connect an amplifier output with any other amplifier output.

Connecting To Your Amplifier: Bridged (Mono) Operation

Pairs of channels may be independently bridged – channel pair 1+2, and/or channel pair 3+4.

The method is the same for both channel pairs:

Select the required bridged mode using the rear panel switches (see page 15 for more information).

Use Channel 1 or 3's Output Speakon connector and connect as follows:

Pin 2+: Hot

Pin 1-: Cold

When operating in bridged mode, the minimum impedances are doubled.

The minimum load in bridged mode is 4 ohms.

Operating Your Amplifier: Front Panel Controls and Indicators

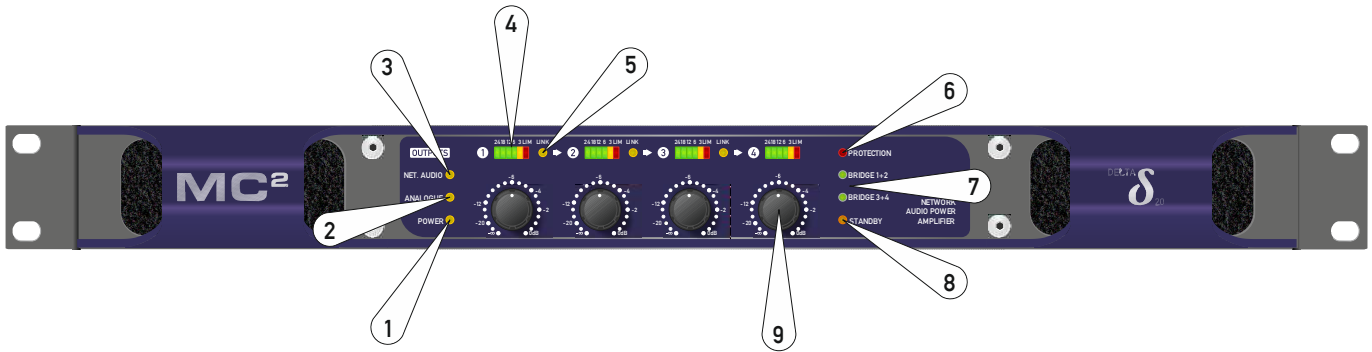

- 1: **POWER LED:** This will illuminate when mains power is connected – there is no on/off switch on this model.
- 2: **ANALOGUE LED:** This will illuminate when the selected source is the four input XLRs.
- 3: **NETWORK AUDIO LED:** This will illuminate when the selected source is the network audio connection. To switch modes, use the rear panel switch as explained further on page 17.
- 4: **Signal meters:** These will show the level of the respective amplifier's output channel. The red LED in the meter will illuminate when the limiter threshold has been reached and limiting is occurring.
- 5: **LINK LEDs:** This indicates if the channel is linked to its immediate neighbour. The link switches are on the rear panel – see page 15 for details. Linking is disabled in Network Audio mode and Link LEDs will be extinguished. The front panel attenuators will still operate independently when channels are input linked.
- 6: **PROTECTION LED:** If a condition exists, that could cause damage to either the amplifier or the speakers, the protection circuit will disengage the outputs and this LED will illuminate/flash. This signal is also connected to a GPO pin on the rear panel for external monitoring – see page 18 for more information. Temperature related faults will reset automatically if the unit has cooled sufficiently.
- 7: **BRIDGE pair LEDs:** The channel pair LED will illuminate if these channels have been switched into bridged (mono) mode. If this is illuminated, the attenuation control of the even numbered channel (so 2 or 4) will not function as both channels are being fed from the left hand channel. See page 13 for details of how to connect your speaker to a bridged channel pair, and page 15 for how to enable bridge mode.
- 8: **STANDBY LED:** The power amplifiers in the Delta 20 can be powered down leaving just the input circuitry and Dante network audio card (if fitted) active. This LED illuminates when the power amplifier sections are turned OFF.
- 9: **Analogue level controls:** These function in both analogue input and network audio input mode. To switch modes, use the rear panel switch as explained further on page 17.

Operating Your Amplifier: Rear Panel Sockets and Switches

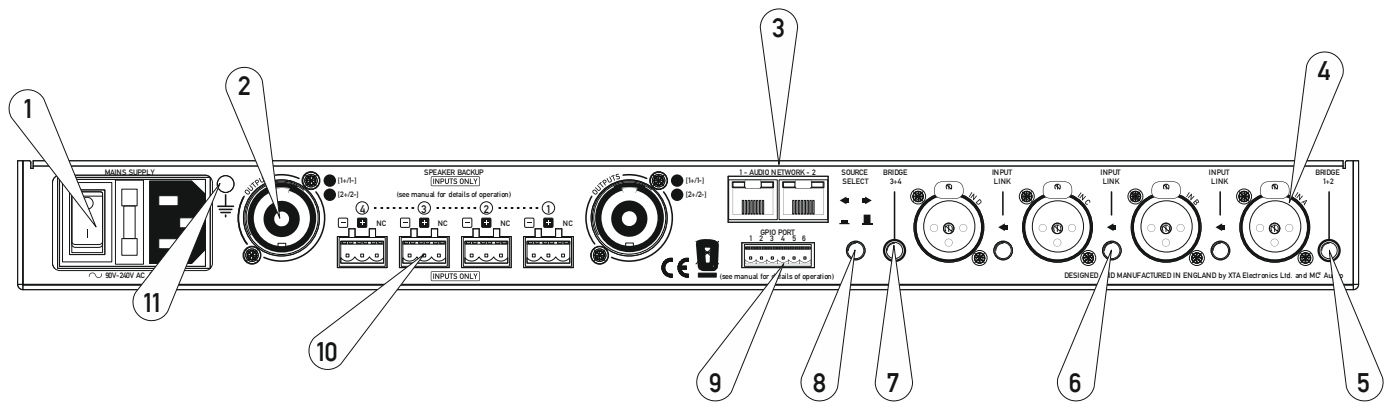

1: Mains input: IEC 3 pin (may not be switched on some versions – fuse is then internal)

2: Channel output Speakon socket: Output 1 is on pins 1+ hot, 1- cold. Channel 2's output is also wired to this socket to enable a single NL4 to provide both channels and to facilitate easier wiring in bridged mode. Channel 3's is wired pins 1+ hot, 1- cold. Similarly channel 4's output Speakon socket carries Channel 4's output wired pins 2+ hot, 2- cold. Check the legend on the rear panel for details.

3: Audio network connections: Four additional inputs can be added to the available input choices via the optional Dante network card.

4: Input XLR sockets: Connect signal inputs to these sockets, wired pin 2 hot, 3 cold, 1 ground. For sensitivity and impedance of these inputs, see the specifications on page 23.

5/7: Bridged (mono) switch (1+2)/(3+4): Press this switch to run this pair of amplifier channels in bridged mode. To run 1+2 bridged, press the switch on the far left of the panel, beside channel A's input XLR.

6: Link switches: Press this switch to link the input of the channel to its immediate left. Multiple channels may be linked using these switches so, for example, to link all outputs to input A, press all three switches IN and use input A only. The front panel attenuators will still operate independently when channels are input linked. Linking is disabled in Network Audio mode and Link LEDs will be extinguished.

7: See 5/7 above.

8: Source select switch: This selects either the four analogue input XLRs or the output of the network audio card as the audio source. It operates globally across all four channels. See page 17 for more information.

9: GPIO connections: 6 way mini-Phoenix connector. The amplifier reports back its status and can be placed into standby using these connections. See page 18 for more information.

10: Speaker Backup Inputs: These sockets can be used to connect a backup amplifier that will automatically be switched in circuit should the main amplifier lose power, or go into "Protect". See Appendix I on page 25 for further information on how to use this feature.

11: Technical Earth Point: Minimise interference by earthing directly to this connection. See page 9 for information on RF emissions.

Operating Your Amplifier: Initial Set-up and Switching On

Please read all documentation before operating your amplifier and retain all documentation for future reference.

Do not spill water or other liquids into or on the unit and do not operate your amplifier while standing in liquid.

Do not block fan intake or rear ventilation outlets or operate the unit in an environment that could impede the free flow of air around the unit.

If your amplifier is used in an extremely dusty or smoky environment, it should be cleaned of any collected debris at regular intervals. Please also see the notes regarding maintenance on page 17.

It is important that the power output of your amplifier is matched to the power handling capacity of your loudspeaker. If not, damage to the loudspeaker could occur.

Switching On...

At 'switch-on' the protection circuit will initially activate whilst the circuits stabilise, indicated by the red Protection LED illuminating, in addition to various other LEDs. After a few seconds the red Protection LED will extinguish indicating a satisfactory working condition.

Other LEDs may remain illuminated depending upon rear panel switch settings and input connections. If the Protection LED does not extinguish after 5 seconds the unit may be faulty or some external connections may be incorrect or inappropriate. If this occurs, you should power down the unit and remove all external connections (except for the mains power supply) and repeat the power up sequence. If the problem persists please contact us – details on page 22.

Operating Your Amplifier: Switching between analogue & networked audio

Your amplifier may be fitted with a Dante network audio card, which includes 24-bit 96kHz high performance analogue to digital converters, allowing the amplifier to use four channels chosen from a Dante network.

As the digital audio network will most likely be running at a higher level compared to your analogue inputs, we strongly recommend you turn the front panel attenuators to minimum before switching modes.

To switch to network audio mode, depress the rear panel switch marked “Source Select”.

Slowly increase the levels again after the mode has been changed.

You will need to use Dante Controller to choose which channels to feed to the amplifier’s inputs. It can be downloaded free here:

<https://www.audinate.com/products/software/dante-controller>

The amplifier’s inputs will appear in a manner similar to the example below:

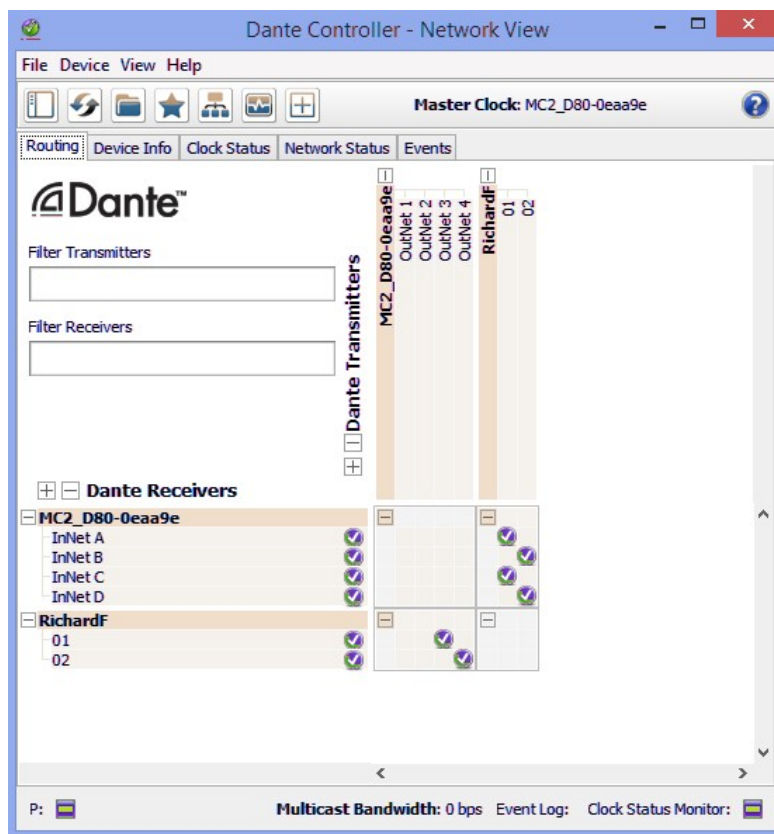

Note that the rear panel “Link” switches do not function in Network Audio mode as any linkage can be set up as part of the source selection within Dante Controller. Front panel “Link” LEDs will also extinguish.

Operating Your Amplifier: General Purpose Connections (GPIO) Port

The 6-way mini-Phoenix connector on the rear panel of the Delta 20 allows the amplifier to report back to building management systems on its operating state and permits the amplifier to be remotely switched in and out of standby.

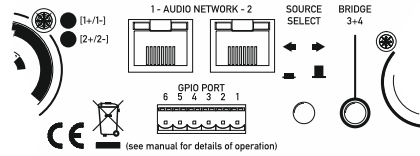

The pins are configured as described in the table:

Port Pin #	Pin Description
1	Chassis ground
2	Electrical ground (0V)
3	Standby input – short to 0V to put amplifier in standby
4	Power on – active high – +5V denotes amplifier is ON (but may be in standby)
5	Standby output – active high – +5V denotes amplifier is in standby (auto/remote/Dante)
6	Protect – active low – 0V denotes amplifier is in PROTECT

Internal Adjustments to Your Amplifier: Fixed fan speed

These instructions are for use by qualified personnel only. Before any routine maintenance, please ensure that your amplifier is disconnected from the mains supply!

In noise sensitive environments, the auto-fan speed adjustment may be disabled. This will set the fans to a low, less audible speed which will not vary considerably with temperature.

Please be aware that this will also therefore limit the amplifier's ability to cool itself and so it will instead reduce power output when high demands are placed upon it.

The feature can be enabled by changing an internal link, CN27, (labelled "High Power Link") as shown below:

CN27 open:
Fans are fixed
low speed.

CN27 linked:
Fans are
temperature
controlled.

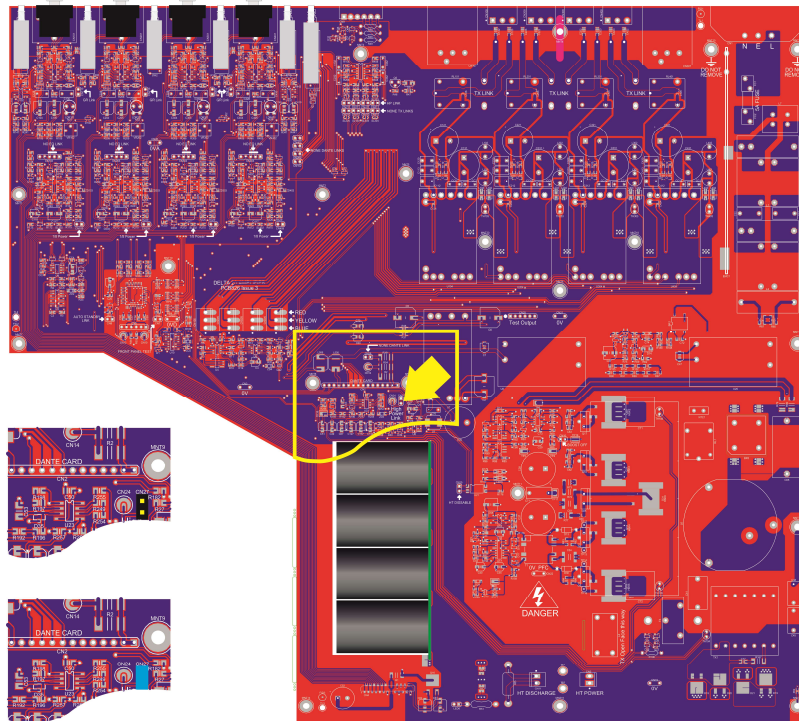

Internal Adjustments to Your Amplifier: Auto-standby mode

These instructions are for use by qualified personnel only. Before any routine maintenance, please ensure that your amplifier is disconnected from the mains supply!

The Delta 20 will switch itself into standby after 10 seconds of no signal (less than -60dBu) on its inputs. This feature is disabled by default and depends on the selected source – if analogue is selected, this will be the source that can “wake” the amplifier up again, and if Dante is selected, then this will control the auto-standby feature.

The feature can be enabled by changing an internal link as shown below:

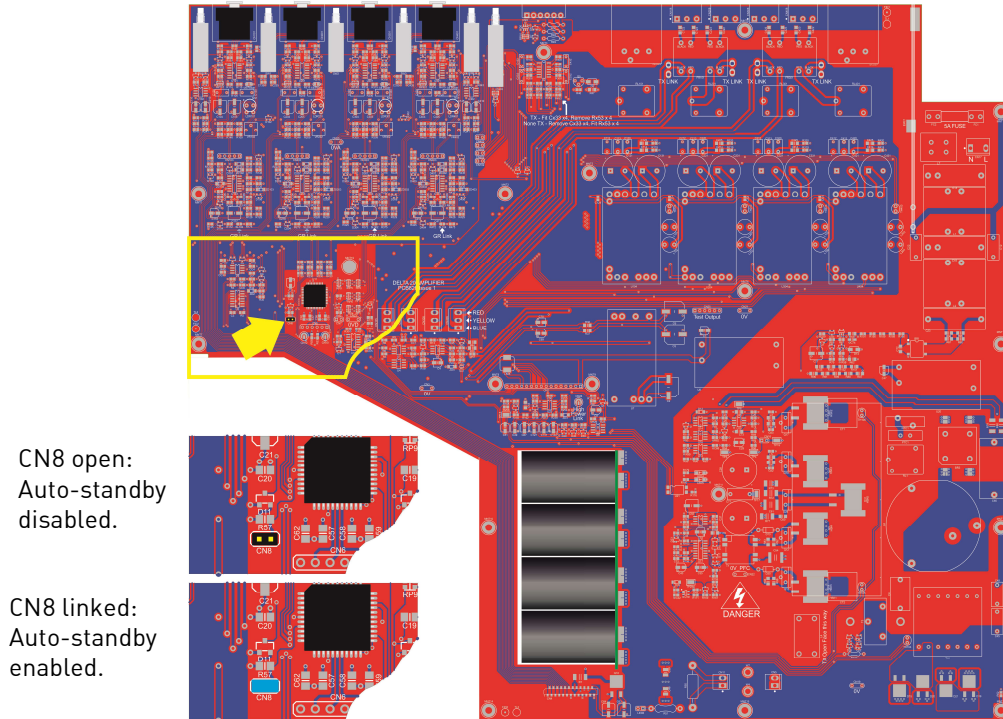

CN8 open:
Auto-standby
disabled.

CN8 linked:
Auto-standby
enabled.

Internal Adjustments To Your Amplifier: Changing the Gain

These instructions are for use by qualified personnel only. Before any routine maintenance, please ensure that your amplifier is disconnected from the mains supply!

Gain/Sensitivity Settings

Adjustment is by internal solder link as shown below – one link for each channel. Channel A's link is number 1 (SL102), channel B's is number 2 (SL202) and so on. The gain may be set to 20dB, or 26 (no link - factory default setting).

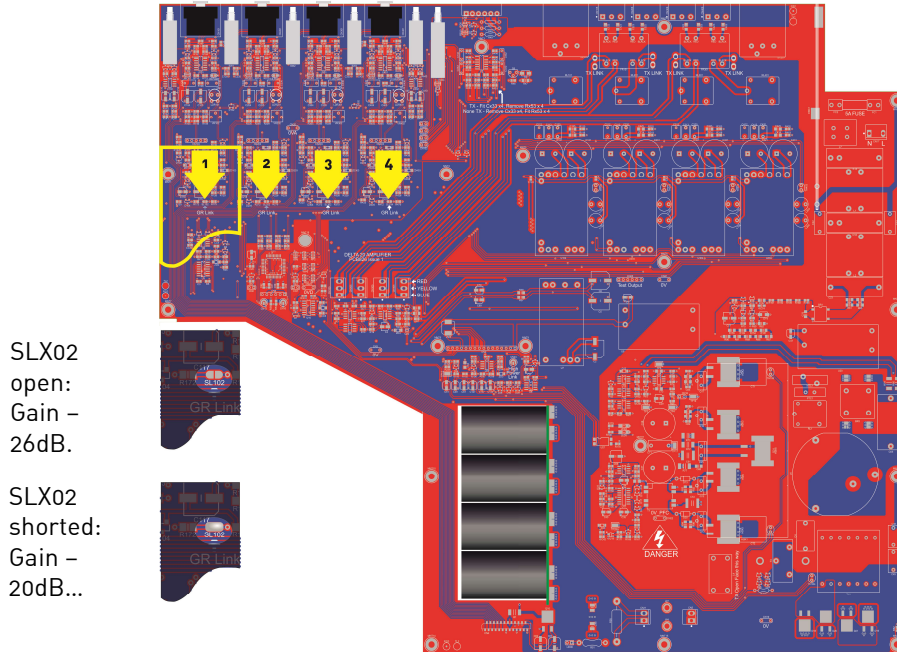

Remember, setting higher gain does not change the maximum available power but changes the level of signal input to achieve maximum power. In any case, provided that the input signal is less than 20dBu/7.7V, the built in limiter circuit will prevent distortion within the amplifier.

The gain should be set to match the signal level from the source – using the network audio inputs will normally result in the amplifier running “hotter” than usual, so adding these links and turning down the front panel attenuators will help.

Note that if 100V line output transformers are fitted then this link will be added as part of the factory fit procedure, along with the enabling of the high pass filter to prevent transformer core saturation.

We recommend changing all four channels together to avoid any confusion once the top cover has been refitted!

Looking After Your Amplifier: Maintenance

These maintenance instructions are for use by qualified personnel only. Before any routine maintenance, please ensure that your amplifier is disconnected from the mains supply!

The filter behind the air intake apertures on the front of your amplifier should be cleaned or replaced periodically, e.g. 3-6 months. (Filters in amplifiers located in more 'dirty' atmospheres may require more frequent maintenance).

The filter should be 'dry' cleaned, using a vacuum cleaner preferably. Running the unit without a filter is not recommended. We recommend replacement of filters every 2-3 years, depending on usage. Replacement filter material is available directly from us.

If the fan vents on the rear of the amplifier develop a build-up of dust/debris on the finger guards, they can be cleaned with a dry paintbrush and a vacuum cleaner.

The casework of the amplifier may be cleaned with a lightly dampened cloth – do not use any solvents as they will damage the paint finish and could remove printing.

If you have any doubts about carrying out maintenance, please refer to a service engineer or contact your local dealer.

Looking After Your Amplifier: Warranty

Your amplifier is guaranteed for a period of five (5) years from the date of manufacture. Please note that this does not apply to OEM versions of the amplifier – please consult your manufacturer for their warranty terms. We hope that it gives you many more years of reliable service than this, but should anything go wrong, please contact us to advise you about repairs or any spares you might require.

Please do not attempt to repair the amplifier yourself as doing so will invalidate the warranty.

Our contact details are:

MC² Audio,
Units 6-8 Kingsgate
Heathpark Industrial Estate
Honiton, Devon
England
EX14 1YG

Tel: +44(0)1404 44633

Fax: +44(0)1404 44660

email: sales@mc2-audio.co.uk for general enquiries

Our website is a great place to get started if you have any questions regarding the general use of your amplifier or need copies of this manual in digital form, or datasheets and photographs. The datasheets also contain architect's and engineer's specifications.

www.mc2-audio.co.uk

Performance Of Your Amplifier: Specifications

Main Specifications

Parameter (Units)	Delta 20
Output Power one channel [continuous music CF 4.8] (Watts)	
2 Ohms	340
2.7 Ohms	480
4 Ohms	350
8 Ohms	175
50 Ohms [70/100V line TX]	200
Output Power all channels [continuous music CF 4.8] (Watts)	
8 Ohms	175
4 Ohms	350
2.7 Ohms	480
2 Ohms	340
50 Ohms [70/100V line TX]	200
Output Power bridged pair [continuous music CF 4.8] (Watts)	
8 Ohms	700
4 Ohms	660
THD+N, 4 Ohms (%)	
@1kHz, 1dB below max output power <	0.01
@20Hz - 20kHz, 1dB below max output power <	0.03
Gain Options (dB)	26
Sensitivity Options for max power (dBu)	8.3
Sensitivity Options for max power (Volts)	2.0
Frequency Response, +0/0.3dB (Hz)	20 – 20000
Power Consumption, Nominal @ 240V, 4 Ohms (A)	0.74
Power Consumption, Nominal @ 120V, 4 Ohms (A)	1.53
Dimensions H x W x D (mm)	
Amplifier	44 x 482 x 428
Boxed	100 x 580 x 590
Boxed Shipping – all except UK	140 x 610 x 600
Weight (kgs)	
Amplifier (No TX)	5.1
Boxed – shipping	5.9

Additional Specifications

Parameter (Units)	Delta 20
Input Impedance – Active Balanced (Ohms)	10k
Input CMRR (dB)	> 30
Damping Factor, 1kHz, 8 ohms	> 200
Signal Limiters Present	Yes
Protection Present – Short Circuit / DC Output / Temperature	Yes
Mains In-rush Control Present	Yes
High Impedance Transformer Outputs	
Max voltage 50R load (Volts Peak)	145
Max voltage 50R load (Volts RMS)	103

Due to continuing product improvement, the above specifications are subject to change.

Performance Of Your Amplifier: Thermal Specifications

Power Consumption and Thermal Emissions – Delta 20

Mains (V)	Load (R)	Current Draw (A)				Thermal Emissions (W)			
		No Sig'l	Light	Average	Heavy	No Sig'l	Light	Average	Heavy
240	8	0.12	0.26	0.40	0.75	28	30	32	35
240	4	0.12	0.40	0.65	1.21	28	34	36	50
240	2.7	0.12	0.49	0.63	1.10	28	45	46	61
120	8	0.27	0.60	0.85	1.60	32	35	37	40
120	4	0.27	0.85	1.40	2.50	32	38	40	55
120	2.7	0.27	1.00	1.30	2.25	32	48	50	66
100	8	0.33	0.7	1.2	2	33	39	41	44
100	4	0.33	1	1.9	3.1	33	41	44	62
100	2.7	0.33	1.2	1.9	3	33	49	51	72

No Sig'l = Quiescent, Light = Crest Factor of 7.8(18dB),

Average = Crest Factor of 4.8(14dB), Heavy = Crest Factor of 2.8(9dB)

For details of measurement methods please refer to the Technical Support area of our website.

Appendix I: Speaker Backup Inputs

It is possible to configure a secondary amplifier as a backup device for use in safety-critical applications, which will automatically be switched into circuit should there be a failure of the main amplifier.

Failure could include loss of power, over-temperature protection or accidental remote enabling of standby.

To use this feature, the backup amplifier must also be an MC² Delta 20, or an XTA DNA20. Do NOT attempt to use another manufacturer's amplifier or any Delta/DNA/DPA amplifier that is not fitted with this feature.

Connect the two amplifiers as shown below:

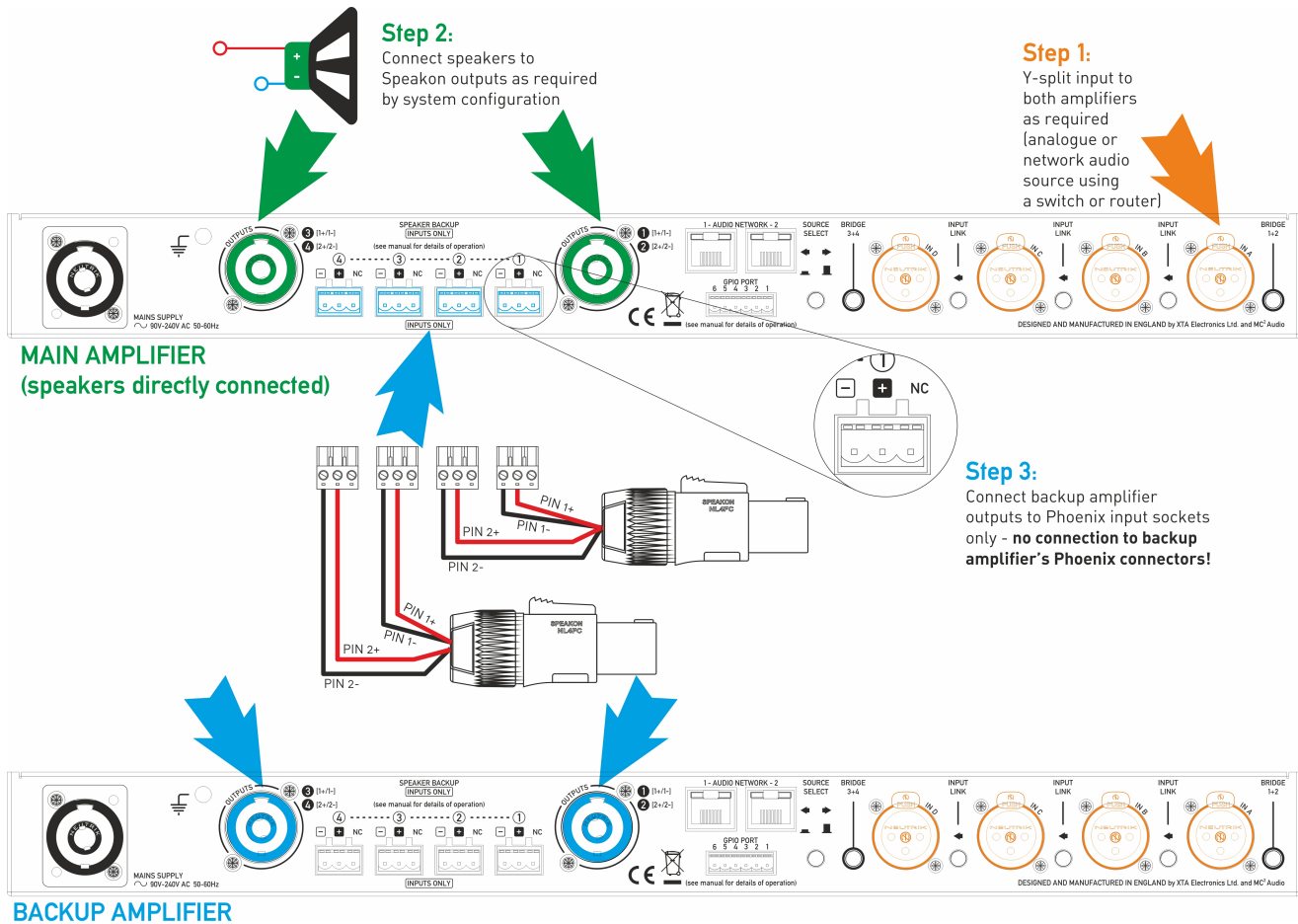

Step 1: Connect both amplifiers' inputs to the required sources and make sure both amplifiers are configured the same for routing, and source (analogue/network).

Step 2: Connect speakers to the MAIN amplifier as normal in the required configuration.

Step 3: Connect link cables from the Speakon outputs of the BACKUP amplifier to the Backup inputs of the MAIN amplifier, being careful to observe the correct polarity on the Backup inputs. Two Phoenix connectors are wired to each Speakon for each pair of channels.

Both amplifiers must remain powered up and out of standby at all times. Should the main amplifier fail, its output relays will disengage and in doing so, connect the outputs from the backup amplifier directly to the Speakon speaker outputs via the Phoenix inputs.

Appendix II: 70/100V line output operation

Your amplifier may be fitted with voltage step-up transformers enabling operation at higher impedances for use with 70V or 100V line distributed speaker systems. This option is factory fit only, and may be fitted to individual channels. Bridge mode should NOT be used once transformers are fitted – you will not damage the amplifier, but the transformers will be effectively bypassed when attempting to connect in bridge mode.

The option will also include a high pass filter to prevent saturation of the transformers at low frequencies – this is standard practice for 70/100V line systems.

It may not be obvious if your amplifier has been fitted with transformers – the quickest way to determine if this is the case is to check the base of the chassis – there are four indentations towards the front left – if these are open with a square hole, no transformer is fitted.

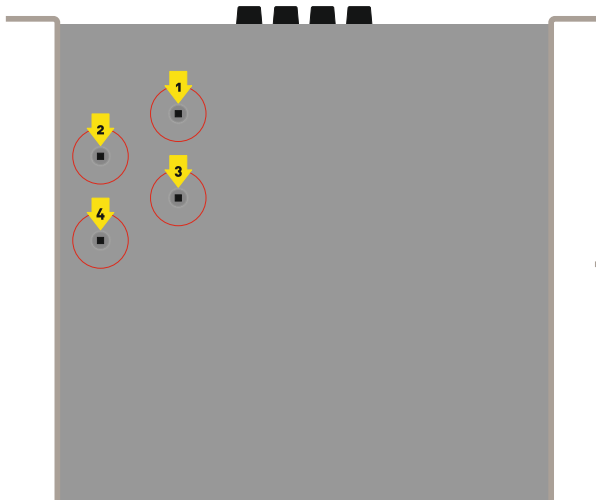

If the indentations have silver bolt heads in them then transformers are fitted to this amplifier.

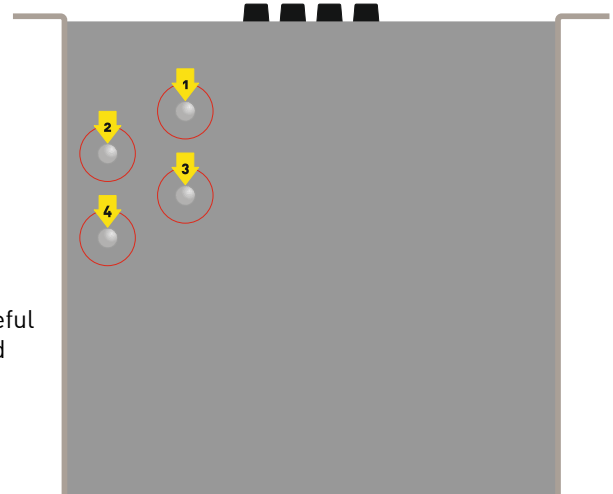

Please read Appendix III in this manual for some useful background information on 70/100V line systems and their use.

Appendix III: 70/100V line distributed audio systems

Introduction

Distributed audio, particularly for speech applications, will often require many speakers to be positioned around a venue, to provide even coverage at acceptable levels in all locations. These speakers may be spread over a considerable area and involve long cable runs to achieve this. Using low impedance “traditional” methods would introduce unacceptable losses due to the actual resistance vs. the speaker impedance – it is easy to envisage a situation where the length of the cable could cause 50% loss in available power.

Using heavier gauge cabling can go some way to reducing the losses, but this often is costly and entirely impractical where many speakers are involved. Borrowing the method used to distribute mains electricity across long distances, where mains supplies are stepped up (using transformers) to higher voltages and stepped down for local consumption also works for distributed audio.

This method helps because, as the voltage is increased, to achieve the same power delivery there is a corresponding decrease in the current that must travel along the conductors. Lower current requirements means thinner gauge cabling and lower losses due to the square law of power delivery. Thinner gauge cabling therefore also means reduced costs, and lower amplifier power requirements than if each speaker (or at best a few speakers) required an individual amplifier channel.

How It Works

Firstly, a few misconceptions around the name of this method should be clarified. It is true that the low voltage/higher current output of a standard audio amplifier is fed into a step-up transformer to produce a higher voltage/lower current output that can travel longer distances using thinner cables. This incurs fewer losses than a direct connection of a low impedance speaker directly over the same distance.

However, the concept of this system operating at either a “constant voltage”, or “100V”, or “70V” is slightly wrong. The system does NOT have a constant voltage output of any sort, unless a constant level of audio is being fed into the amplifier (such as a sine wave), at which point the output will be at a constant level. This would hold true in the low impedance (standard) case too. There is no extra method of modulating a fixed voltage, or there being a permanent high voltage output on the speaker lines.

The use of the terms “100V line” or “70V line” comes from the description of the system running at full power output only. The transformer used to step up the voltage should be chosen so that, when the amplifier is running at full power, the voltage across the lines will then be 100V (or 70V or whatever has been deemed appropriate for the given application). The only thing that is “constant” with this type of system is rated voltage at the amplifier’s rated power. So, whether it’s a 30W amplifier for distributing speech to some horns by a racetrack, or a 300W amplifier distributing music and announcements throughout a warehouse, both the systems will produce 100V (or whatever) when the amplifier is running at maximum power.

The majority of the time, the voltages present on the lines will be an order of magnitude less than 100V, as the audio being delivered will be at a much lower level than full output (assuming the amplifier chosen is up to the job!).

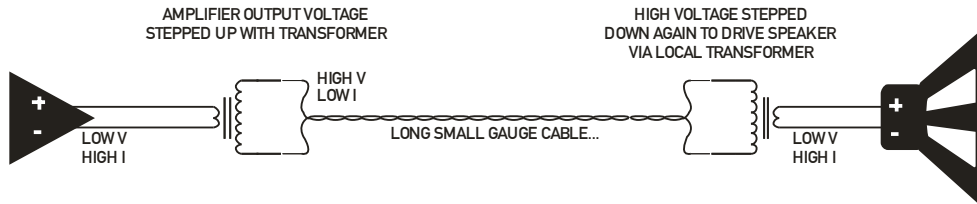

Once the voltage has been “stepped up” to the higher level for long distance transmission, when it reaches the speaker, in common with mains power reaching its destination, there must be some form of “stepping down” again to restore it to a voltage/current suitable for driving the speaker. This is achieved by using a localised “step-down” transformer, normally attached directly to the speaker chassis itself, or in the enclosure with the driver.

From this point on, the process for working out how many speakers can be connected to an amplifier channel becomes relatively simple, but remember one thing – this doesn’t change the laws of physics – just as there is a limit to how many speakers can be connected in parallel on a “normal” channel of an amplifier, there is still a limit for 100V or 70V systems too!

Example: How many speakers can I connect to an amp channel?

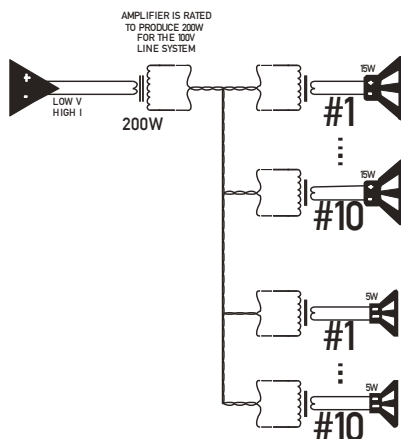

We’ll start with an amplifier capable of supplying 200W to a 100V line system. This total “pool” of 200W can be split up any way we want to as many speakers as we want, providing their requirements don’t exceed 200W in total.

The requirement of any particular 100V line configured speaker is quoted as a power rating for a given SPL output. Let’s say we have decided upon two sizes of ceiling speaker for a given installation – one rated at 15W and one rated at 5W. Ignoring the SPL ratings for now, it’s a reasonable assumption to make that the “15W” speaker will be generating a higher output level than the “5W” speaker (for any given voltage on the line).

Remember – this wattage value isn’t the power rating of the driver – this is the power it will consume from the amplifier – the speaker’s rating itself is not relevant (and is unlikely to be quoted as part of the speaker’s specification).

So, to work out how many speakers the amplifier can handle, it’s as simple as adding up the number of 15W speakers we want to use and the number of 5W speakers, and making sure this total is no more than the 200W we have available.

Let's say we have worked out that we need 10 of the 15W speakers, for starters – that comes to $10 \times 15W = 150W$, leaving us with 50W "spare", which means we could connect another 10 of the 5W speakers. That's 20 areas in total – not bad for just 200W!
This is in an ideal world of course...**now for how it really works!**

Calculating Real World Requirements

The choice of amplifier power, in an ideal world, would allow us to do this simple calculation and everything to operate perfectly with the power available exactly matching the power delivered to the speakers. However, this isn't an ideal world, and there are two main factors that impede (!) this from being true – losses in the cables themselves, and insertion losses in the step-up and step-down transformers.

Whilst it is theoretically possible to calculate these losses, there is a "Catch 22" situation in play here, which means that even measuring the real world losses through cables in a system becomes impossible. Getting hold of insertion loss information for transformers is difficult, and in order to measure the losses, you need to build the system, which you can't do until you specify your amp power, which you can't do until you measure the losses!

Thus, there is a reliable "rule of thumb" that states that **amplifier power should be approximately 50% bigger than your speaker power requirements would suggest**. So, if your speakers total power comes to 100W per channel, go for an amplifier nearer 150W per channel to account for all the losses and ensure you deliver the power and so SPL you require.

Getting The Best Performance

As 100V line systems are primarily intended for background music applications and foreground delivery of speech program only, the necessity for the highest fidelity audio has never been paramount. This does not mean that a carefully designed system can't perform to a high audio standard – it can, but there are certain constraints that need to be considered when evaluating performance.

Due to the fact that transformers are in use throughout a 100V line systems, being careful not to saturate the cores of these transformers with excessive energy is paramount to the system not just working well, but not damaging the amplifier. Low frequency power tends to be the main culprit for this condition, and a saturated transformer core appears as a very low impedance across the amplifier's output terminals, close to a direct short, resulting in early amplifier overheating, protection circuits muting the audio unnecessarily and generally bad behaviour! It manifests itself, in audio terms, as a distorted rasping sound – similar to how a misaligned voice coil might sound.

This can be easily avoided by ensuring that high pass filters are fitted to all channels to limit the low frequency content of the system. We recommend fitting crossover cards to our amplifiers, or inserting suitable filtering using an external speaker management system, such as the XTA DP4 and 5 Series. The minimum response requirement is -3dB @ 70Hz and 12dB/Octave roll off below this.

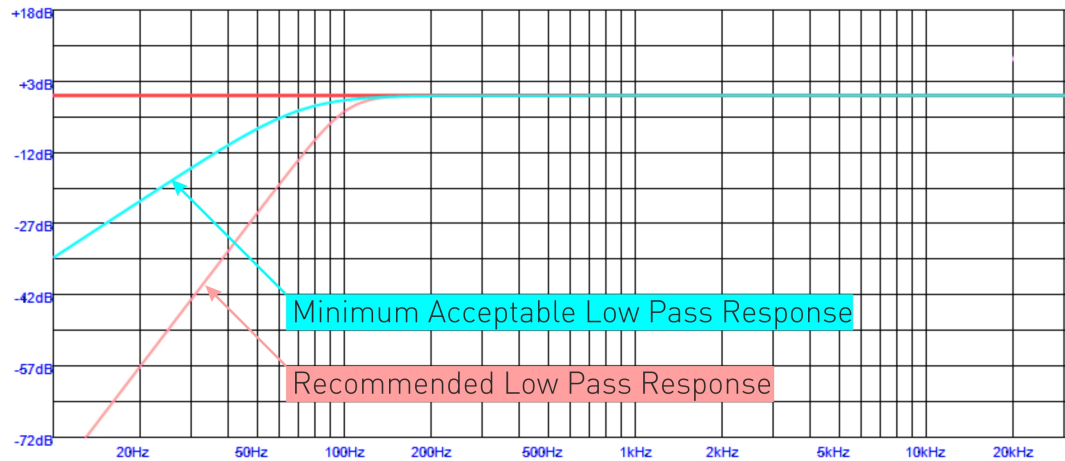

All ranges of MC² amplifiers can be fitted with these cards – please contact us for more information.

Note that the Delta 20 has a built-in HPF (100Hz HPF with a roll-off of 24dB/Octave Butterworth) which is enabled as part of the procedure when the step-up transformers are fitted – it does not use the crossover card insert points – these are still free for other use.

Working Without Step-Up Transformers

In most circumstances, the power output of amplifiers used in 100V line systems is only in the order of a few hundred watts, due to the total power requirements of the multiple small speakers being installed only reaching this sort of figure.

However, higher powered amplifiers are capable of generating a voltage swing sufficient to drive a 100V system without the need of a set-up transformer. There may be circumstances when using a larger amplifier is required – for instance when the amplifier's usage is being split to provide distributed audio on one channel and local higher power on another (perhaps for a sub-bass system) or if there is an unusually large number of higher power 100V line speakers on the system.

The following MC² amplifiers may be used without a step-up transformer – as mentioned earlier, whilst their maximum output voltage may not reach 100V, they are capable of being operated transformerless if required.

Note this refers only to the step-up transformer at the amplifier – the speakers will still require their individual step-down transformers. MC² also still advise using a high pass filter on channels driving a 100V line system.

T & Ti Series

3500: 90v
2000: 70v
1500: 130v bridged nearly 65v normal.
1000: 115v bridged

E Series

90: 140v
100: 105v
45: 100v
60: 80v
25: 75v
15: 120v bridged
475: 80v in 8 ohm mode, 120v bridged 4 ohm mode

In Conclusion...

Working with distributed audio using the 100V line system need not be a complex undertaking – just remember these key points:

- If in doubt about how much power you need, go for your upper estimate – an underpowered system will perform worse in all circumstances, not just when the system is being driven hard!
- Always fit high pass filtering on each amplifier channel to prevent premature amplifier failure and circumvent poor audio performance.

MC² manufacture a special external 100V line transformer system for use with certain T and Ti Series models – this product is called “T-Line” and can be loaded with a variety of transformers according to system requirements. More information on this is on our website here:

http://www.mc2-audio.co.uk/images/stories/datasheets/tseries/tline_datasheet.pdf