

linärie

---

---

# BURGUNDY

---

---

## Retro Wine Fridge

---

---

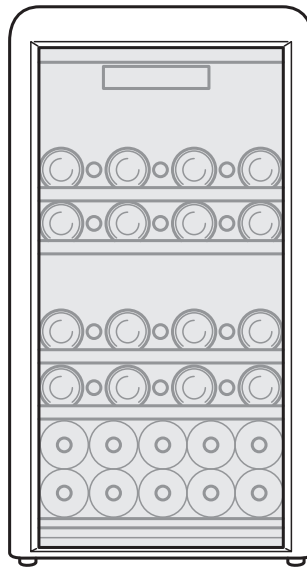

• *LICV33RED*

**EN** Operation, Installation  
& Instruction Manual

[www.linarie.com.au](http://www.linarie.com.au)

Register  
your  
product  
online

# CONGRATULATIONS

Congratulations and thank you for choosing Linärie to introduce a new comfort of cooking in your home. We are sure you will find your new appliance a pleasure to use and a great asset to your kitchen.

This appliance complies with all relevant safety requirements in Australia. Inappropriate use can, however, lead to personal injury and damage to property.

In order to operate the unit correctly and safely, please read this instruction manual carefully before installation and usage. This user manual which provides you with all required instructions related to safety, installation, use and maintenance of the appliance.

For future reference, please store this booklet in a safe place and ensure that all users are familiar with the contents. Pass them on to any future owner of the appliance.

Record Model & Serial Number

Model:.....

Serial Number .....

Register your product [www.linarie.com.au](http://www.linarie.com.au)

## IMPORTANT

Adherence to the directions for use in this manual is extremely important for health and safety. Failure to strictly adhere to the requirements in this manual may result in personal injury, property damage and affect your ability to make a claim under Linärie's manufacturer's warranty provided with your product. Products must be used, installed and operated in accordance with this manual. You may not be able to claim on Linärie's manufacturer's warranty in the event that your product fault is due to failure to adhere this manual.

### Correct Conditions of Use

- The appliance is intended for use in the home and similar environments only. It is not intended for commercial use.
- The appliance is not suitable for outdoor use, non-stationary installation.
- This wine cooler can be only used to store various types of wines

 The electricity connection must be made by a qualified specialist. Installation must comply with the valid standards, regulations and laws. All safety and warning information and the operating and installation instructions must be complied with.



**WARNING** This symbol means that the safe operation of the product and the personal safety of the operator are concerned, and that the operation must be performed in strict compliance with the requirements as specified



**CAUTION** This symbol means that the operator must pay attention to the information as described



**NOT ALLOWED** This symbol means that the behavior as described is not allowed

## TABLE OF CONTENTS

<b>1. General Information</b> .....	03	<b>7. Methods of operation</b> .....	06
1.1 Appliance information		<b>8. Routine maintenance &amp; care instruction</b> ..	07
<b>2. General Safety Instructions</b> .....	03	<b>9. Storage of wine</b> .....	08
2.1 General safety information		<b>10. Ideal wine temperature</b> .....	08
2.2 Safety instruction - Installation		<b>11. Troubleshooting</b> .....	09
2.3 Correction use & Operation .....	04	<b>12. Environmental tips</b> .....	10
2.4 Disassembling and Disposal of the Appliance		12.1 Disposal considerations	
2.5 Accessories and Spare parts		12.2 Disposing your old appliance	
<b>3. Technical data sheet</b> .....	05	<b>13. Warranty and After sales</b> .....	10
<b>4. Name of components</b> .....	05	13.1 Warranty	
<b>5. Precautions for installation</b> .....	06	13.2 After sales service	
<b>6. Precautions for operation</b> .....	06	13.3 Replacement of spare parts	

Additional information on products, accessories, warranty, replacement parts and services can be found at [www.linarie.com.au](http://www.linarie.com.au)

# 1. GENERAL INFORMATION

## 1.1 Appliance Information

- A damaged appliance can be dangerous. If you find the appliance is damaged or marked, you must report it within 7 days if you wish to claim for damage/marks under the manufacturer's warranty. This does not affect your statutory rights. Do not use a damaged appliance.
- The manufacturer's warranty will be invalidated if the appliance is not repaired by a Linärie approved service technician.
- Faulty components must only be replaced by genuine Linärie spare parts. The manufacturer can only guarantee the safety of the appliance when Linärie replacement parts are used.
- If the power cord is damaged, it must only be replaced by a Linärie authorized service technician or suitably qualified electrician in order to avoid a hazard.
- Linärie cannot be held liable for noncompliance with these instructions, resulting from incorrect or improper use or operation.

# 2. GENERAL SAFETY INSTRUCTIONS

 The appliance complies with the stipulated safety requirements in Australia. The user is responsible for appliance cleaning and maintenance as well as its safe use. Improper use can lead to personal injury and damage to property.

## 2.1 General Safety Instructions

### Children and People with Special Needs

#### WARNING

This appliance is not intended for use by persons (including children) with reduced physical, sensory or mental capabilities, or lack of experience and knowledge, unless they have been given supervision or instruction concerning use of the appliance by a person responsible for their safety.

- The appliance is NOT suitable for use by children without supervision.
- Young children should be supervised near the appliance to ensure they do not play with this appliance.
- Children may be able to wrap themselves in packing material or pull it over their heads with the risk of suffocation. Keep children away from any packing material.

### Unauthorized Modifications

Unauthorised modifications can cause the appliance to pose risks. Do not conduct any modifications to the appliance.

### Cleaning & Maintenance

The device must be cleaned regularly. Dirt can lead to damage or the buildup of odors. (See "Cleaning and maintenance" section).

- Always clean the appliance exactly as indicated in the operating instructions.
- Always ensure the appliance is switched off before cleaning or replacing parts.
- Clean the appliance immediately after any food spillage and the filter regularly to keep the appliance working efficiently.
- There is a risk of fire if cleaning is not carried out as described in these operating instructions.
- Make sure no water penetrates inside the device when cleaning. Do not use a steam cleaning appliance to clean this appliance. The steam could reach electrical components and cause a short circuit.
- In areas which may be subject to infestation by cockroaches or other vermin, pay particular attention to keeping the machine and its surroundings in a clean condition at all times. Any damage which may be caused by cockroaches or other vermin will not be covered by the machine warranty.

## 2.2 Safety Instructions - Installation

#### WARNING

The appliance must only be installed and assembled by trained specialists who are familiar with and comply with the standard national regulations and supplementary regulations of ventilation systems.

- In order to avoid any potential hazard, the installation instructions must be followed.
- Observe all regional regulations for the installation of ventilation systems.
- During installation, maintenance and repair work, the appliance must be disconnected from the mains electricity supply. It is only completely isolated from the electricity supply when:
  - the mains circuit breaker is switched off, or
  - it is switched off at the wall socket and the plug is withdrawn from the socket.
- Do not pull the mains connection cable but the mains plug to disconnect your appliance from the mains electricity supply.
- Do not connect the appliance to the mains electricity supply by a multi-socket unit or an extension lead.
- Extension leads are a fire hazard and do not guarantee the required safety of the appliance.
- Tampering with electrical connections or components and mechanical parts is highly dangerous to the user and can cause operational faults. Only open the housing as described in the instructions given in "Installation" section of this booklet. Under no circumstances should any other parts of the housing be opened.
- Do not use mechanical devices or other means to accelerate the defrosting process, other than those recommended by the manufacturer.
- Do not damage the refrigerant circuit.

- THIS APPLIANCE MUST BE PROPERLY EARTHED. It is most important that this basic safety requirement is present and tested regularly and, where there is any doubt, the household wiring system should be inspected
- Due to the special characteristics of the tempered glass, the tempered glass may be exploded at the probability rate of 3‰- 5‰ according to the industrial estimate, while this company will strictly control it within 3‰.
- After the wine cooler is installed in place, the plug shall be easily accessible to facilitate the removal of the cooler plug in case of any accident.

by a qualified electrician.  
Linärie cannot be held liable for noncompliance with these instructions, resulting from incorrect or improper use or operation.

- Regarding the information pertaining to the installation, handing, maintenance, servicing and disposal of the appliance, thanks to refer to the paragraph "ROUTINE MAINTENANCE and CARE INSTRUCTIONS" and "TROUBLESHOOTING" of the manual.

## 2.3 Correction use and Operation

- For safety reasons, this appliance may only be used after it has been built in.
- Reliable and safe operation of this appliance can only be assured if it has been connected to the mains electricity supply.
- Before using the appliance, ensure that all packaging materials are removed from the appliance and make sure that the connection data on the data plate [voltage (V) and frequency (Hz)] indicated on the appliance corresponds to the voltage and frequency of the power supply in your household. Consult a qualified electrician if in doubt.
- DO NOT store or spray flammable materials in the appliance or near this appliance while it is in operation (e.g. aerosols).
- Cracks, fissures or fractures in the glass ceramic panels can damage the underlying electronics. Switch off and disconnect the appliance immediately.
- Prevent water ingress. Never sprinkle or flush the cooler using water, nor place the cooler in an area exposed to moisture or water sprinkling, let alone filling the cooler with water, so as to avoid impairment of the electric insulativity of the cooler. Furthermore, failing to follow such requirements may lead to electric shock and fire, or other accidents.
- After the cooler is put into operation, never touch its inner icing surface, especially when your hand is wet; otherwise the skin may stick onto the inner surface to get injured.
- Clean regularly surfaces that can come in contact with food and accessible drainage systems. If the refrigerating appliance is left empty for long periods, switch off, defrost, clean, dry, and leave the door open to prevent mould developing within the appliance.
- Opening the door for long periods can cause a significant increase of the temperature in the compartments of the appliance.

### WARNING

The refrigerant isobutane (R600a) is contained within the refrigerant circuit of the appliance, a natural gas with a high level of environmental compatibility, which is nevertheless flammable. During transportation and installation of the appliance, ensure that none of the components of the refrigerant circuit becomes damaged.

## 2.4 Disassembling and Disposal of the Appliance

(see the "Environmental Tips" section for best practices on disposing of this appliance).

The device must only be disassembled by trained specialists who are familiar with and comply with the standard national regulations and supplementary regulations of the local utility companies.

Work on electrical components must only be conducted by trained electrical personnel.

## 2.5 Accessories and Spare parts

Incorrect components can lead to personal injury or damage to the appliance. Only use original Linärie spare parts for repairs.

Modifications, additions or alterations to the appliance can lead to safety risks. If spare parts or accessories from other manufacturers are used, the warranty will be invalidated, and Linärie cannot accept liability.

Please check [www.linarie.com.au](http://www.linarie.com.au) for more information.

### 3. TECHNICAL DATA SHEET

Model	LICV33RED	LICV52BLUE	LICV106GREEN
Rated voltage	220-240V ~		
Rated frequency	50Hz		
Climate type	N / ST		
Rated current	0.8A		
Rated power of lamp	1.0W		
Volume	94L	126L	201L
Refrigerant	R 600a/18g	R 600a/18g	R 600a/22g
Dimensions (width *depth* height) 480*505*880	480*505*880	495*605*905	495*605*1325

### 4. NAME OF COMPONENTS

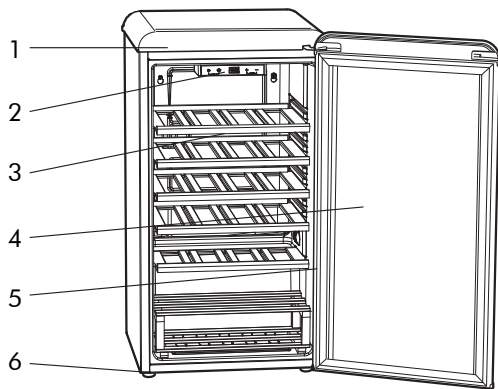

#### LICV33RED

1	Top cover
2	Display panel
3	Shelf
4	Glass door
5	Door gasket
6	Adjustment leg

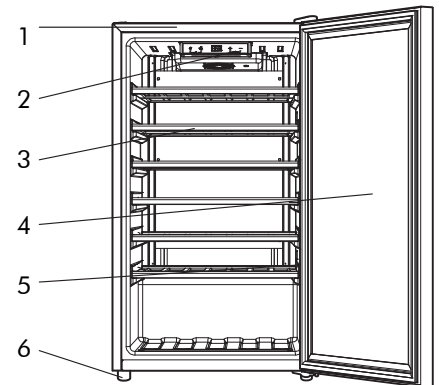

#### LICV52BLUE



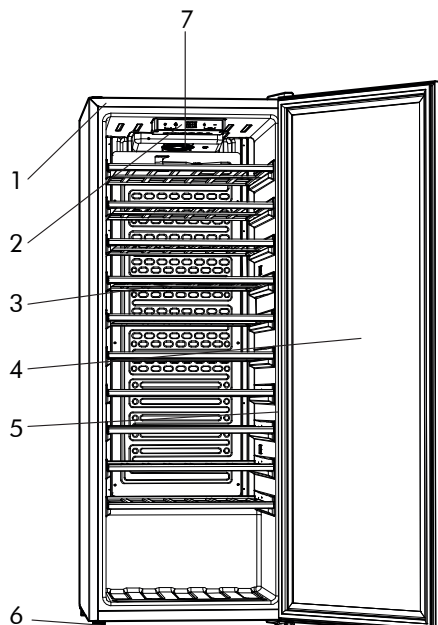





1	Top cover
2	Display panel
3	Shelf
4	Glass door
5	Door gasket
6	Adjustment leg



#### LICV106GREEN

1	Top cover
2	Display panel
3	Shelf
4	Glass door
5	Door gasket
6	Adjustment leg
7	Fan

## 5. PRECAUTIONS FOR INSTALLATION

-  The fridge shall not be tilted over 45° when being handled, and it can be electrified only 10 minutes after handling operation.
-  The fridge must be placed on a flat and solid ground surface. If it needs to be elevated, a stable, solid and inflammable pad shall be used. Never the packaging foam as the pad to elevate the fridge.
-  Do not place the fridge in the area exposed to moisture or water splash. The water splash or on the fridge shall be timely removed using the soft cloth to prevent rusting and impairment of electric insulativity.
-  Do not place the fridge in an environment lower than 5 Celsius degree, nor use it in the rain. The fridge shall be kept far away from the heat source and protected against sunshine, to avoid influencing the normal operation of the fridge.
-  The appliance is only applied with power supply of single phase alternating current of 220~240V/50Hz. The device uses a wall socket earthed according to current recommendations.
-  If the power cable is damaged, do not proceed with his replacement but contact your after-sales service.
-  The socket must be readily accessible but out of reach of children. If unsure, contact your installer.
-  The fridge shall be well ventilated; otherwise the normal operation of the fridge may be adversely influenced. The ventilated space must be at least 20cm from the both sides of the fridge and 10cm from the top and back sides of the fridge.

## 6. PRECAUTIONS FOR OPERATION

1. Clean the fridge.
2. Keep the fridge level. After the fridge is leveled and cleaned, do not electrify it immediately. Keep the fridge stationary for more than 2 hours, and then electrify it to ensure the normal operation of the fridge.
3. Close the fridge door, and insert the power line. After the power supply is switched on, the fridge will start to work. If the fridge fails to work in a long period of time, check whether the power socket and the electric circuit work normally. If, half an hour later, an abrupt reduction of temperature is detected after the fridge door is opened, the cooler works normally. After 2~3 hours, adjust the temperature and then fill wines according the instruction. It is normal the compressor will work for a longer time for the initial plugging, and then works intermittently.
4. Generally, do not stop the fridge, to avoid influencing its normal service life. After the power line plug is removed, wait for at least 5 minutes before inserting it again, to ensure the normal operation of the fridge.
5. Do not switch off the power supply of the fridge when unnecessary, because the power interruption may cause temperature rise inside the fridge, thus to shorten the storage term of wines and degrade their drinking quality.
6. A certain space shall be maintained between wine bottles, which will facilitate the circulation of cool air. The figure illustrates the layout of shelves that result in the most efficient use of energy for the refrigerating appliance.
7. It is not allowed to flush the fridge body using water, nor to wipe the body using the gasoline or other organic solvents.
8. If the power cord is damaged, it must be replaced by the professional of the manufacturer, its repair department or any similar department to avoid any danger.
9. All power sockets must be reliably earthed.
10. The system shall be set up during the initial operation of the product for better protection of this product.

## 7. METHODS OF OPERATION

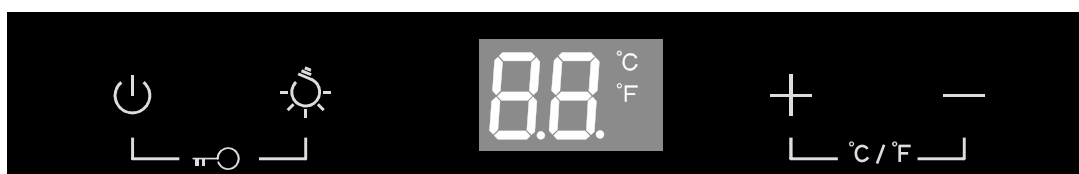

 Power key

 Illumination lamp key

 Temperature "+" key

 Temperature "-" key

### Quick start



#### Child lock key (combined key)

Lock: No setting can be changed when the lock is activated. Lock is automatically activated 30 seconds after a setting is changed or there is no activity. When engaged, pressing any key will result in a 2 beep alarm.

Unlock: To deactivate the auto lock, press both keys simultaneously for 5s. Any operation should be in unlock mode.

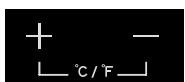

#### Celsius degree/ Fahrenheit degree switchover key (combined key)

Press both keys simultaneously for 5s, and then you can switch over between the Celsius degree and Fahrenheit degree for display. Each time the key is pressed, a switchover will be made.

When setting the system temperature, it is not allowed to switch over between the Celsius degree and Fahrenheit degree.

## cont. methods of operation



### Power on/off key:

1. Press this key for 5S, and then all external power sources will be disconnected and all external equipment will be turned off, with the cooler in ready mode, the display screen will indicate "oF" for 60s.
2. When the cooler is in the ready mode, touch any key to light the display screen and then press this power key for 5S, the cooler will restore its normal operation and work under real-time conditions.



### Lamp on/off key:

The lamp control key is a cycling key: Normally on --> Normally off --> Normally on.



### Temperature "+" key:

1. Functions of temperature "+" key: In locked mode, the action of any key is detected, the display screen will indicate the current set temperature. After unlock operation, this key can be operated to increase the set temperature by 1°C each time the key is pressed. The display screen will indicate the current set temperature in a flashing way and at a certain interval, and 5s later, if no further action of this key is detected, the setting after adjustment will be memorized, and the screen will exit from the flashing mode and restore the indication of the set temperature.
2. Rules of temperature adjustment: For example: 5°C (current set temperature) -->6°C -->7°C -->8°C --> . . . -->20°C.



### Temperature "-" key:

1. Functions of temperature "-" key: this key can be operated to decrease the set temperature by 1°C each time the key is pressed. The display screen will indicate the current set temperature in a flashing way and at a certain interval, and 5s later, if no further action of this key is detected, the setting after adjustment will be memorized, and the screen will exit from the flashing mode and restore the indication of the set temperature.
2. Rules of temperature adjustment: For example: 20°C (current set temperature) -->19°C -->18°C -->17°C --> . . . 5°C.

## 8. ROUTINE MAINTENANCE AND CARE INSTRUCTIONS

1. To develop the best performance of this machine and prolong its service life, it shall be serviced frequently. Before maintenance, the power line plug shall be removed and it shall be confirmed that the power supply has been cut off.
2. It is not allowed to remove the power line plug from the socket by pulling the cable.
3. The cooler inside shall be thoroughly cleaned every year. To clean the cooler, the plug shall be removed and the cooler shall be emptied. Then the cooler inside shall be cleaned using the wet soft cloth or sponge dipped with clean water or soap liquid (or any other non-corrosive neutral cleanser). It is not allowed to clean the cooler using the organic solvent, alkaline detergent, boiled water, washing powder or acid and the like.
4. In the humid environment or in the rainy weather, the cooler surface may be dewed, especially on the external surface of the glass door. This is caused due to the contact with the moisture in the air. In such a case, the surface can be dried using the dry cloth.
5. To ensure the normal operation of the cooler in a long period of time, the user should inspect the cooler on a regular basis; if any abnormality is found, the manufacturer shall be notified of the same immediately.
6. During cleaning operation, it is not allowed to use the water to flush the compressor compartment of the cooler. After cleaning operation, the cooler shall be wiped using the dry cloth to prevent rusting.

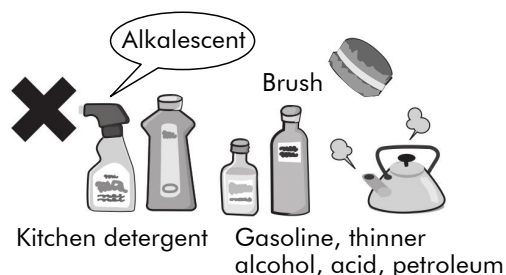

## 9. STORAGE OF WINE

### Red wine storage zone:

The storage zone is mainly intended to ensure the storage of your red wine under the best conditions.

The temperature of the storage zone has been set at 12°C at the delivery, and this temperature is suitable for the storage of most of wine products.

The red wine is provided with a complicated nature due to its length of treating process. To express its best feature, a specific environment is needed. Although all of wine products are manufactured at the same temperature, they need to be preserved and tasted under different temperature conditions due to their special features.

Therefore, as for the coolers of the wine manufacturer, the absolute temperature is not essential for the storage of wine.

However, a steady temperature is very important within a certain period of time. The wine can be properly preserved at any temperature as long as its temperature is not changed.

## 10. IDEAL WINE TEMPERATURE

Amarone Classic Dry Red Wine 17°C  
Amarone Classic Dry Red Wine 17°C  
Barbaresco Wine 17°C  
Barolo Wine 17°C  
Beaujolais Wine 13°C  
Bordeaux Blanc 6°C  
Dry white wine 8°C  
Bordeaux Red Wine 17°C  
White Burgundy 11°C  
Red Burgundy 18°C  
Brunello Wine 17°C  
Champagne 6°C  
Chianti Classico 16°C  
Languedoc-Roussillon 13°C

Passito di Pantelleria 6°C  
Provence Rose 12°C  
Sweet Sparkling Wine 6°C  
Verdicchio di Matelica & Verdicchio dei Castelli di Jesi 8°C  
Trentino White Wine 11°C  
Franciacorta White Wine 11°C  
Aromatic White 10°C  
Fruity Dry White 8°C  
Friulano Venetian Julia White Wine 11°C  
Rodano White Wine 15°C  
Loire Dry White Wine 10°C  
Loire Liqueur Wine 10°C  
Loire Red Wine 14°C  
Passito Liqueur Wine 8 - 18°C  
Rose Wine, New Wine 12°C  
Light Red Wine with Malt Tannins 14°C  
Red Wine with a Little of Tannins 16°C

### Disusing

If it is not used for a long time, turn off the wine cooler, pull out the plug and take off the safety device or break the fuse. Do a good job in cleaning and open the cabinet door so that no smell will be produced.

## 11. TROUBLESHOOTING

If you find any abnormality during operation, immediately stop the operation, remove the power line plug, and check the machine according to the following instructions. If necessary, contact the after-sales service center of this company.

Status	Reason and solution	
Too high noise.	The fridge is not level.	Level the fridge, for the unlevelled fridge may produce noise during operation.
The fridge doesn't work.	The power supply is not switched on.	Switch on the power supply.
	The computer board is damaged.	Notify the manufacturer for repair.
	The compressor is provided with a protection mode	The operation interval of the compressor is 5 minutes.
The fridge door surface is dewed.	The door is opened too frequently or the door is opened for too long time.	Do not open the door for too long time, nor open or close the door too frequently.
	The external environment is highly humid.	Dry using a piece of dry cloth.
	The fridge temperature is set too low.	Set a proper temperature.
The illumination lamp is not lit.	The illumination lamp is damaged.	Notify the manufacturer for replacement of the lamp.
	Check whether the power supply is switched on.	Check the power supply.
The door is not properly sealed and there is a leakage of cool air	The door seal may be hardened or deformed due to the low temperature inside the fridge after operation for a period of time.	Use the hot air of the hair dryer to bake the deformed surface or use the hot towel to cover the deformed surface, and close door and press it tightly after the door seal is softened.
The compressor keeps operating for long time.	<ul style="list-style-type: none"> <li>- If the temperature in the summer is too high, the compressor will work for long time. This is normal.</li> <li>- If the fridge is not cool enough, please check against the following items:</li> <li>- If the fridge door is not properly sealed or the door is opened too frequently, close the door tightly, and open the door at a lower frequency. Do not place too many drinks in the fridge, and maintain a certain space between foods.</li> <li>- If the temperature inside the cooler reaches too low required temperature, check the temperature setup, and set the temperature at a higher level.</li> </ul>	
The refrigerating effect of the fridge is poor.	<ul style="list-style-type: none"> <li>- Adjust the refrigerating level.</li> <li>- The fridge is exposed to sunshine or any heat source is located in its immediate area.</li> <li>- Any hot drink is placed into the fridge.</li> <li>- The drinks in the fridge are crowded to impair the cool air circulation.</li> <li>- The fridge door is frequently opened or is not properly closed.</li> </ul>	
There is any odor in the fridge.	<ul style="list-style-type: none"> <li>- The new fridge may give off the smell of the foaming agent or plastic. That's normal, and such smell will disappear slowly in future.</li> <li>Check whether there is any spoiled drink inside the fridge.</li> <li>Any odorant drink shall be tightly sealed using the plastic bag.</li> <li>The fridge shall be cleaned on a regular basis.</li> </ul>	
The fridge produces the liquid flowing sound.	<ul style="list-style-type: none"> <li>- The sound is generated from the flowing of the refrigerant inside the circulating pipeline of the refrigerating system. That's normal.</li> <li>- No further treatment is required.</li> </ul>	
The fridge produces snapping sound in operation.	<ul style="list-style-type: none"> <li>- This is the sound generated in the startup of electric components, such as the relay and thermal protector, during start or stop of the fridge.</li> </ul>	
	<ul style="list-style-type: none"> <li>- This is caused by the mutual fine movements of various kinds of materials due to the inconsistent thermal expansion and contraction arising out of abrupt changes of the fridge inside temperature when the fridge is being started or stopped.</li> </ul>	

## 12. ENVIRONMENTAL TIPS

Observe all safety and warning information during operation (see the "General Safety Instructions" section).

### 12.1 Disposal considerations

The transport and protective packaging has been selected from materials which are environmentally friendly for disposal, and can normally be recycled.

Recycling the packaging reduces the use of raw materials in the manufacturing process and also reduces the amount of waste in landfill sites. Ensure that any plastic wrappings, bags etc. are disposed of safely and kept out of the reach of babies and young children. Danger of suffocation.



### 12.2 Disposing of your old appliance

Electrical devices marked with this label may not be disposed of in domestic waste at the end of their service life.

Electrical and electronic appliances often contain valuable materials. They also contain specific materials, compounds and components, which were essential for their correct function and safety. These could be hazardous to human health and to the environment if disposed of with your domestic waste or if handled incorrectly. Please do not, therefore, dispose of your old appliance with your household waste.

Please dispose of those materials by contacting your local authorities and ask for the correct method of disposal. Please ensure that your old appliance poses no risk to children while being stored prior to disposal.

By disposing of this product in accordance with the regulations, you protect the environment and the health of those around you from negative consequences.

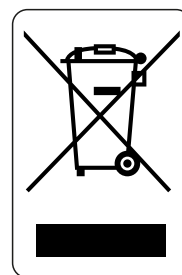

## 13. WARRANTY & AFTER SALES SERVICE

Observe all safety and warning information during operation (see the "General Safety Instructions" section).

In the event of a fault which you cannot remedy yourself, please contact Linärie.

### 13.1 Warranty

The manufacturer's warranty for this appliance is 2 years.

### 13.2 After sales service

The contact details for Linärie are given at the beginning and of these instructions.

When contacting Linärie, please quote the model and serial number of your appliance. These can be found on the data plate, after removing the grease filter.

### Record model & serial number

Model:.....

Serial Number:.....

Register your product [www.linarie.com.au](http://www.linarie.com.au)

### 13.3 Replacement of spare parts

Incorrect components can lead to personal injury or damage to the appliance. Use only genuine original Linärie spare parts.



Modifications, additions or alterations to the appliance can lead to safety risks. If spare parts or accessories from other manufacturers are used, the warranty will be invalidated, and Linärie cannot accept liability.

Please check [www.linarie.com.au](http://www.linarie.com.au) for more information.

## LIKE TO KNOW MORE?

For further information on all Linärie appliances,  
or to obtain detailed dimension and installation  
information, phone or email our Customer Care  
team or visit our website:

Australia  
[hello@linarie.com.au](mailto:hello@linarie.com.au)  
[www.linarie.com.au](http://www.linarie.com.au)

Follow Us  
[@Linarie.Appliances](#)  
  

© Linärie

Operating and installation instructions:

Original

√ Translation

**Mart Online Services Pty Ltd.**  
**ACN 657 824 050**

**Linärie Contact**  
**hello@linarie.com.au**  
**www.linarie.com.au**

The distribution and duplication of this document, as well as the use and disclosure of its contents are prohibited unless expressly authorised.

These operating and installation instructions have been drawn up with the greatest of care. But it cannot be ruled out that subsequent technical modifications have not yet been incorporated or the relevant content has not yet been adapted. Please accept our apologies in this eventuality. An updated version can be requested from our team. Subject to printing errors and mistakes.

© Linärie

All rights reserved.