

***insē***

# USER MANUAL

Cordless Stick  
Vacuum Cleaner

**N5/N5S/N500  
N550/N560/N570**

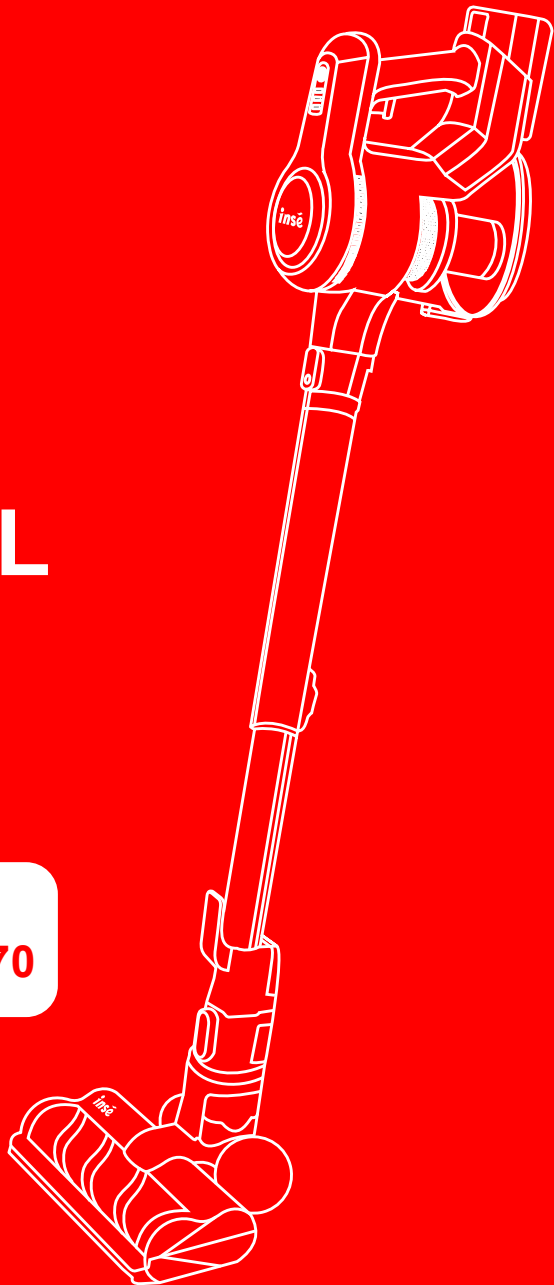



# CONTENTS

<b>Product Parts List and Schematic</b>	<b>01</b>
<b>Product Technical Parameters</b>	<b>03</b>
<b>Safety Warning</b>	<b>03</b>
<b>Assembly and Combinations</b>	<b>05</b>
<b>Ready to Use</b>	<b>06</b>
<b>Charge</b>	<b>07</b>
Charge Method	07
Battery Indicators	07
Battery Safety	08
<b>Storage</b>	<b>09</b>
<b>Daily Maintenance</b>	<b>09</b>
Clean Handheld Part of the Main Motor	09
Clean Detachable Roller Brush	10
Clean Dust Cup & Strainer & Filter	10
<b>Troubleshooting</b>	<b>11</b>
<b>Warranty</b>	<b>11</b>
<b>Warning</b>	<b>12</b>

# Product Parts List and Schematic

Main Motor X1

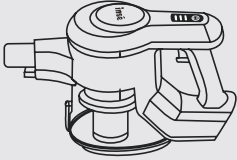

Battery Pack X1

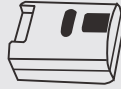

Motorized Cleaner Head X1  
(with Roller Brush)

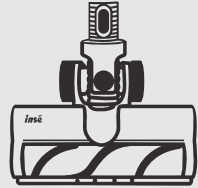

Retractable Metal Tube X1



Wall Mount X1



2 in 1 Brush X1

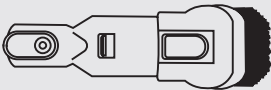

Long Crevice X1

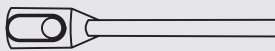

Power Adapter X1

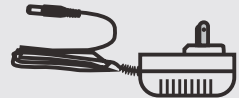

2 in 1 Cleaning Tool X1



User Manual X1



Quick Start Guide X1



**INSE Products are eco-friendly. When the machine is worn out or no longer in use, please contact your local authority for recycling instructions.**

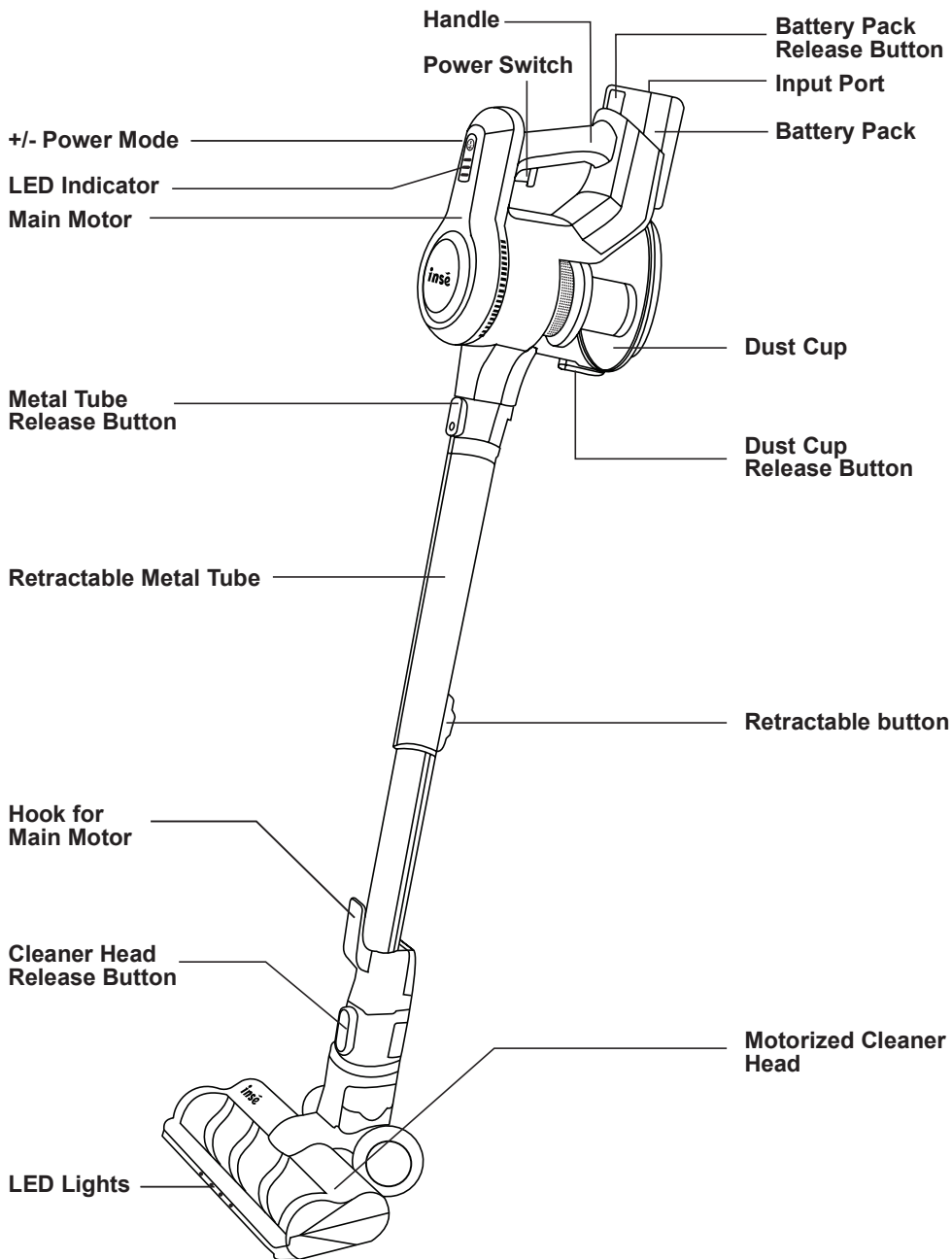

## Product Technical Parameters

Product Category	Vacuum Cleaner	Product Model	N5
Dust Cup Capacity	1.2L	Rated Voltage	22.2V
Product Net Weight (Handheld Dust Machine)	1.5kg	Rated Power	145W
Product Weight (Including All Attachments)	2.8kg	Charging Time	5.5hours
Power Adapter Input	100-240V~50/60Hz	Battery Capacity	2200mAh
Power Adapter Output	27V 500mA	/	/

## Safety Warning

- When using electrical appliances, basic safety precautions should always be followed.
- Check the voltage indicated on the rating plate and confirm you connect the appliance to the power supply with correct voltage.
- Children whose aged from 8 years and above, people who with reduced physical, sensory or mental capabilities or lack of experience and knowledge can use this appliance, only if they have been given supervision or instruction concerning to use the appliance in a safe way and understand the hazards involved.
- Children should be supervised to ensure that they do not play with the appliance.
- This appliance is not a toy.
- If any part is damaged due to human error, only a qualified electrician can repair it. Please note the appliance is not under warranty in this case.

- Improper repairs may put the user in danger.
- Keep away from children aged below 8.
- Keep the appliance away from heat or sharp edges that could cause damage.
- Keep the appliance away from other heat emitting appliances.
- Do not immerse the appliance in water or any other liquid.
- Do not operate the appliance with wet hands.
- Do not expose the appliance to rain.
- Do not remove from the adaptor from the mains power supply by pulling the cord; switch off and remove the plug by hand.
- Do not use the adaptor to recharge non-rechargeable batteries.
- Do not use the appliance if it has been dropped or if there are visible signs of damage.
- Do not use the appliance for anything other than its intended use.
- Do not use any parts/accessories or adaptors other than those supplied with this appliance, as this may cause damage.
- Do not use any damaged accessories or adaptors.
- Do not use this appliance outdoors.
- Do not store the appliance in direct sunlight or in high humidity conditions.
- Do not use if any of its openings are blocked.
- Do not use the appliance to pick up flammable liquid, matches, cigarette ends, hot ashes or any hot, burning or smoking objects.
- Do not use to pick up sharp objects such as glass or screws, etc.
- Do not use to pick up water or any other liquid, as this may cause electric shock.
- Take care when equipping accessories with rotating parts as this could cause entrapment
- Switch off the appliance and disconnect it from the mains power supply before changing or fitting accessories.
- Always ensure that the appliance has cooled fully after use before performing any cleaning or user maintenance.
- Use of an extension power cord with the power adapter is not allowed.
- Only use with provided power adapter.
- This appliance is intended for domestic use only. It should not be used for commercial purposes.

## Caution

- The metal tube contains inner electric connections.
- Do not use to pick up any liquid.
- Do not immerse in water for cleaning.
- The metal tube should be checked regularly and must not be used if damaged.

# Assembly and Combinations

To assemble the powerful cordless stick vacuum cleaner, please follow the instructions as shown.

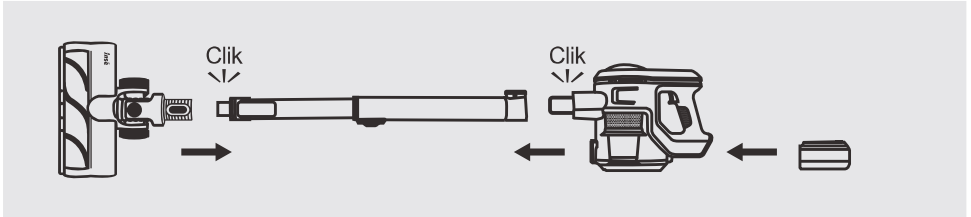

- ❗ Ensure a tight connection of the whole machine by a clear sound of click in each step.
- ❗ If you want to disassemble the vacuum, just press the release button on each part.

If you want to connect it with other attachments and work in different situations, please follow the **COMBINATION** instructions below.

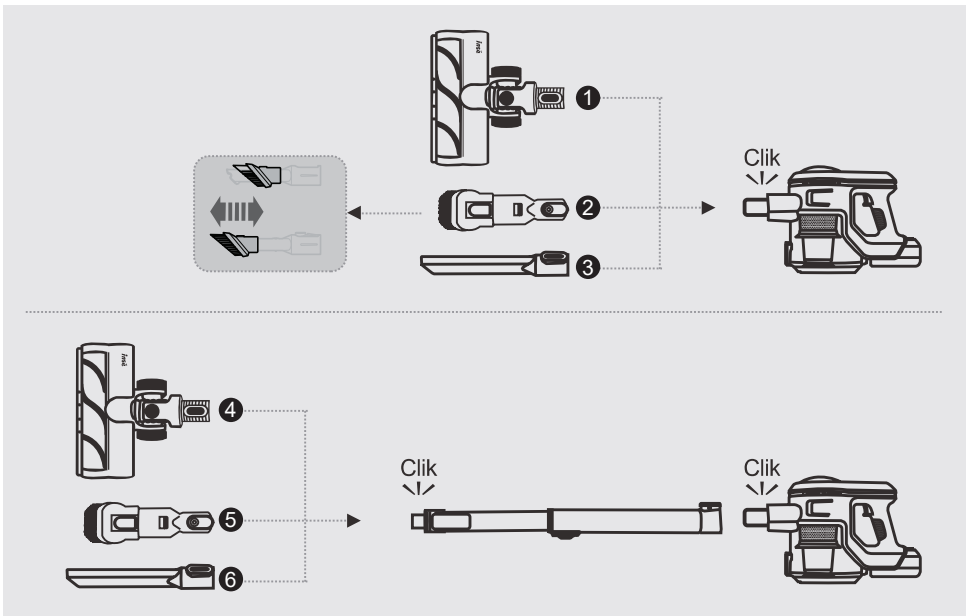

# Ready to Use

## 1. Preparation

Please check if the battery power is sufficient before using. It's suggested to charge over 5-6 hours before the first time of use to ensure utmost performance of the product. Choose the correct attachment according to the cleaning area.

## 2. Start to Work

First-press the Power Switch to turn on the vacuum; second-press it to change to high-suction mode; third-press it to turn it off.

Or you can press the +/- Button to switch between high-suction mode and standard-suction mode.

## 3. Dust Cup Cleaning

Please clean the dust cup in time when the -MAX- sign is approached.

Turn off the machine and then press the dust cup open button to empty it.



# Charge

## Method 1

Insert the battery pack into the main motor and then connect it with the power adapter

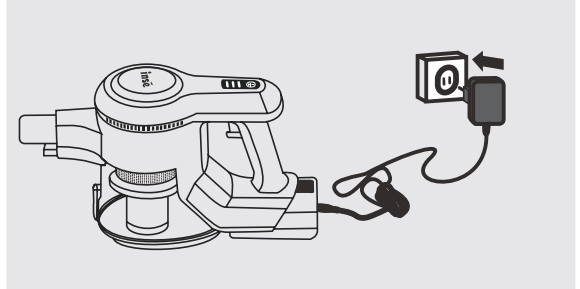

## Method 2

Connect the independent battery with the wall mount then connect it with the power adapter

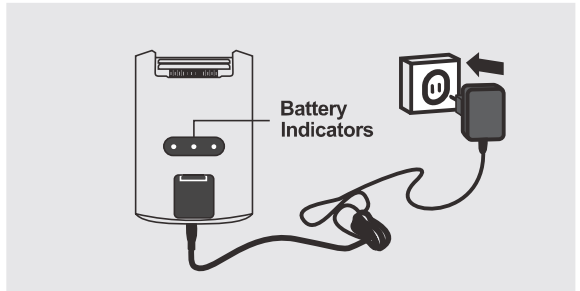

## Battery Indicators

### On Work



- Three solid blue lights: **full power**



- Two solid blue lights: **medium power**



- One solid blue light: **low power**



- One blinking blue light: **lower than 5% of the total power, needs a recharge**

## During Charging

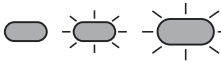

- Three blue lights blinking successively: **charging**



- Three steady lights: **charging complete**

## Notes:

- \* The machine cannot be turned on during charging
- \* Charge the battery only with the adaptor provided by INSE
- \* When you won't use the battery for a long time, please store it in a cool dry place. In this situation, please ensure that the battery has been half charged (2 glowing indicator lights)
- \* If you need an additional battery, please purchase from an authorized distributor of INSE

## Battery Safety

- If the battery pack becomes exhausted, it should be removed from the product to avoid leakage.
- In the event of the battery pack leaking, do not allow any liquid to come into contact with the skin or eyes.
- If contact has been made, wash the affected area with copious amounts of water and seek medical advice.
- Keep the battery pack out of the reach of children.
- Secondary battery packs need to be charged before use. After extended periods of storage, it may be necessary to charge and discharge the batteries several times to obtain maximum performance.
- Do not leave battery packs on charge for prolonged periods of time.
- Do not use any charger other than that specifically provided for use with the product.
- The supply terminals are not to be short-circuited.
- Do not store above 60°C. Avoid storing in direct sunlight.
- Do not use any battery packs that are not designed for use with the product.
- Do not dispose of the battery pack in a fire.
- Do not crush, puncture, dismantle or otherwise damage the battery pack.
- Do not dismantle, open or shred battery packs.
- Do not expose the battery pack to heat or fire as it may explode.
- Do not subject the battery pack to mechanical shock.
- Do not dispose of the exhausted battery pack in household waste.
- To dispose of the exhausted battery pack, take it to a local recycling station.
- Contact the local government offices for further details.
- This appliance is fitted with a 22.2V 2200mAh Li-ion rechargeable battery.

## Storage

### Method 1

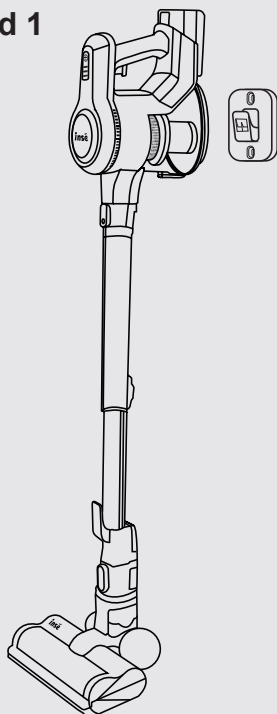

### Method 2

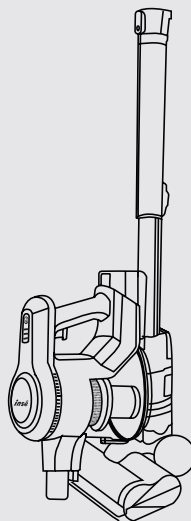

## Daily Maintenance

In order to ensure max performance of the vacuum, please regularly maintain its components.

### Clean Handheld Part of the Main Motor

- ⚠ Please turn off the vacuum before cleaning.
- ⚠ Wipe the surface with a clean cloth; avoid the water getting into the inner part of the vacuum.
- ⚠ Do not place the vacuum under direct sunlight or in wet places after cleaning.

## Clean Detachable Roller Brush

1. Unlock the side lock on the underside of cleaner head, remove the side cover and take out the roller brush.
2. Remove the side cover of the roller brush if necessary.
3. Use the 2-in-1 cleaning tool to remove the tangled hair.

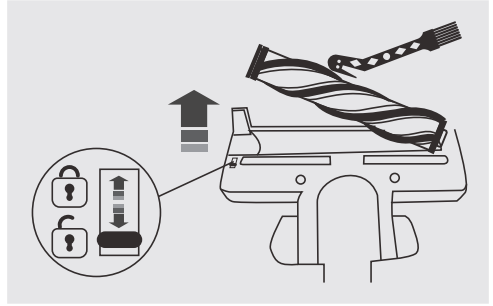

## Clean Dust Cup & Strainer & Filter

- \* Clean the dust cup when -MAX- sign is approached.
- \* Clean the strainer when it is dusty.
- \* Clean the filter regularly, and replace it every 3 months as recommended.

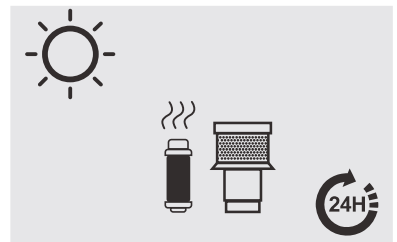
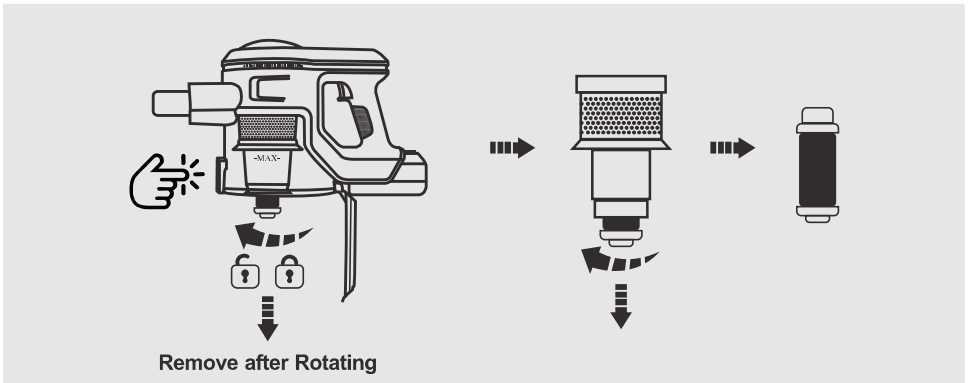

**Note: Do not re-assembly the strainer and filter until they are completely dry.**

## Troubleshooting

Problems		Possible Causes	Solutions
01	Vacuum cleaner doesn't work	<ol style="list-style-type: none"> <li>1. Low battery</li> <li>2. Suction port is blocked</li> </ol>	<ol style="list-style-type: none"> <li>1-1. Charge the main motor with battery inserted</li> <li>1-2. Take out the battery and charge it</li> <li>2. Clean the blockage</li> </ol>
02	Suction power is weaken	<ol style="list-style-type: none"> <li>1. Dust cup and the inner cotton filter is full of dust</li> <li>2. The cleaner head is blocked with hair, spitball or plastic bag, etc.</li> </ol>	<ol style="list-style-type: none"> <li>1. Clean the dust cup and filter</li> <li>2. Clean the cleaner head</li> </ol>
03	Motor has strange sound when working	Main suction port or metal tube are blocked	Clean the blockage
04	Roller brush stops spinning	Roller brush is tangled with hair	Clean all hair tangled with the brush, also remove the side cover of the brush to remove the hair and dust

Please contact [support@inselife.com](mailto:support@inselife.com) if the solution above doesn't help.

## Warranty

### NOTE:

**THIS WARRANTY TERM GIVES YOU SPECIFIC LEGAL RIGHTS, AND YOU MAY ALSO HAVE OTHER RIGHTS WHICH VARY FROM STATE TO STATE.**

### 12-month Warranty & Lifetime Customer Support

Only apply to eligible purchases made directly from the INSE authorized distributors.

Warranty coverage applies to the original owner and to the original product only and is not transferable.

### How to Initiate A Warranty Claim

If your appliance operates improperly while in use under normal household conditions within the warranty period, please contact our customer support [[support@inselife.com](mailto:support@inselife.com)] or visit [www.inselife.com](http://www.inselife.com) to fill out the warranty form to initiate a warranty claim.

For more warranty details, please refer to [www.inselife.com](http://www.inselife.com).

All rights are reserved by INSE official website.

# WARNING

**Read all safety warnings and instructions. Failure to follow the warnings and instructions may result in electric shock, fire and/or serious injury.**

1. Prevent unintentional starting ensure the switch is in the off-position before connecting pack, picking up, or carrying the appliance.  
Carrying the appliance with your finger on the switch or energizing appliance that have the switch on invites accidents.
2. Disconnect the battery pack from the appliance before making any adjustments changing accessories or storing appliance.  
Such preventive safety measures reduce the risk of starting the appliance accidentally.
3. Recharge only with the charger specified by the manufacturer. A charger that is suitable for one type of battery pack may create a risk of fire when used with another battery pack.
4. Use appliances only with specifically designated battery packs.  
Use of any other battery packs may create a risk of injury and fire.
5. When battery pack is not in use, keep it away from other metal objects, like paper clips, coins, keys, nails, screws or other small metal objects, that can make a connection from one terminal to another.  
Shorting the battery terminals together may cause burns or a fire.
6. Under abusive conditions, liquid maybe ejected from the battery; avoid contact.  
If contact accidentally occurs, flush with water.  
If liquid contacts eyes, additionally seek medical help.  
Liquid ejected from the battery may cause irritation or burns.
7. Do not use a battery pack or appliance that is damaged or modified.  
Damaged or modified batteries may exhibit unpredictable behavior resulting in fire, explosion or risk of injury.
8. Do not expose a battery pack or appliance to fire or excessive temperature.  
Exposure to fire or temperature above 130°C may cause explosion.  
The temperature of 130°C can be replaced by the temperature of 265 °F.
9. Follow all charging instructions and do not charge the battery pack or appliance outside of the temperature range specified in the instructions.  
Charging improperly or at temperatures outside of the specified range may damage the battery and increase the risk of fire.
10. Have servicing performed by a qualified repair person using only identical replacement parts.  
This will ensure that the safety of the product is maintained.
11. Do not modify or attempt to repair the appliance or the battery pack (as applicable) except as indicated in the instructions for use and care.

# insē



Please do not hesitate to contact us whenever you want, we are always more than happy to help you!

 [support@inselife.com](mailto:support@inselife.com)

 [www.inselife.com](http://www.inselife.com)

MADE IN CHINA



General Tips, FAQ, etc.  
<https://inselife.com/>



Installation and Usage  
[bit.ly/inseyoutube-n5](https://bit.ly/inseyoutube-n5)