



**WELLS BLOOMFIELD, LLC**  
10 Sunnen Dr., St. Louis, MO 63143  
telephone: 314-678-6314  
fax: 314-781-2714  
[www.wellsbloomfield.com](http://www.wellsbloomfield.com)

**OPERATIONS MANUAL**

**DROP-IN REFRIGERATED  
COLD PANS, NSF7  
RCP-7100, RCP-7200,  
RCP-7300, RCP-7400,  
RCP-7500, RCP-7600.**



*Model RCP-200*

**DROP-IN REFRIGERATED  
COLD PANS, NSF2  
RCP-100, RCP-200,  
RCP-300, RCP-400,  
RCP-500, RCP-600.**

**DROP-IN REFRIGERATED  
COLD PANS, SLOPE TOP NSF7  
RCP-7100ST, RCP-7200ST,  
RCP-7300ST, RCP-7400ST,  
RCP-7500ST, RCP-7600ST.**

**DROP-IN REFRIGERATED  
COLD PANS, SLOPE TOP NSF2  
RCP-100ST, RCP-200ST,  
RCP-300ST, RCP-400ST,  
RCP-500ST, RCP-600ST.**

**INCLUDES INSTALLATION, USE,  
CARE, SERVICE AND DIAGRAMS.**

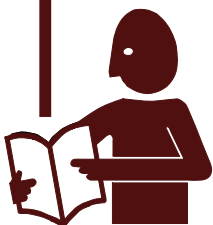

**IMPORTANT: DO NOT DISCARD THIS MANUAL**

This manual is considered to be part of the appliance and is to be given to the OWNER or MANAGER of the restaurant, or to the person responsible for TRAINING the operators of this appliance. Additional manuals are available from your WELLS DEALER.

**THIS MANUAL MUST BE READ AND UNDERSTOOD BY ALL PERSONS USING OR INSTALLING THIS APPLIANCE.** Contact your WELLS DEALER if you have any questions concerning installation, operation or maintenance of this equipment.



## LIMITED WARRANTY STATEMENT

Unless otherwise specified, all commercial cooking equipment manufactured by WELLS BLOOMFIELD, LLC is warranted against defects in materials and workmanship for a period of one year from the date of original installation or 18 months from the date of shipment from our factory, whichever comes first, and is for the benefit of the original purchaser only.

THIS WARRANTY IS THE COMPLETE AND ONLY WARRANTY, EXPRESSED OR IMPLIED IN LAW OR IN FACT, INCLUDING BUT NOT LIMITED TO, WARRANTIES OF MERCHANTABILITY OR FITNESS FOR ANY PARTICULAR PURPOSE, AND/OR FOR DIRECT, INDIRECT OR CONSEQUENTIAL DAMAGES IN CONNECTION WITH WELLS BLOOMFIELD PRODUCTS. This warranty is void if it is determined that, upon inspection by an authorized service agency, the equipment has been modified, misused, misapplied, improperly installed, or damaged in transit or by fire, flood or act of God. It also does not apply if the serial nameplate has been removed, or if service is performed by unauthorized personnel. The prices charged by Wells Bloomfield for its products are

based upon the limitations in this warranty. Seller's obligation under this warranty is limited to the repair of defects without charge by a Wells Bloomfield factory authorized service agency or one of its sub-service agencies. This service will be provided on customer's premises for non-portable models. Portable models (a device with a cord and plug) must be taken or shipped to the closest authorized service agency, transportation charges prepaid, for service. In addition to restrictions contained in this warranty, specific limitations are shown in the Service Policy and Procedure Guide. Wells Bloomfield authorized service agencies are located in principal cities. This warranty is valid in the United States and Canada and void elsewhere. Please consult your classified telephone directory, your foodservice equipment dealer or contact:

**Wells Bloomfield, LLC**  
**10 Sunnen Dr., St. Louis MO 63143 USA**  
**phone (314) 678-6314 or fax (314) 781-2714**

for information and other details concerning warranty.

## SERVICE POLICY AND PROCEDURE GUIDE and ADDITIONAL WARRANTY EXCLUSIONS

1. Resetting of safety thermostats, circuit breakers, over load protectors, and/or fuse replacements are **not** covered by this warranty unless warranted conditions are the cause.
2. All problems due to operation at **voltages or phase other than specified on equipment nameplates** are **not** covered by this warranty. Conversion to correct voltage and/or phase must be the customer's responsibility.
3. All problems due to **electrical connections not made in accordance with electrical code requirements and wiring diagrams** supplied with the equipment are **not** covered by this warranty.
4. Replacement of items **subject to normal wear**, to include such items as knobs, light bulbs; and, normal maintenance functions including adjustments of thermostats, adjustment of micro switches and replacement of fuses and indicating lights are **not** covered by warranty.
5. Damage to electrical cords and/or plug due to exposure to excessive heat are **not** covered by this warranty.
6. Full use, care, and maintenance instructions supplied with each machine. Noted maintenance and preventative maintenance items, such as servicing and cleaning schedules, are customer responsibility. Those miscellaneous adjustments noted are customer responsibility. Proper attention to preventative maintenance and scheduled maintenance procedures will prolong the life of the appliance.
7. Travel mileage is limited to **sixty (60) miles** from an Authorized Service Agency or one of its sub-service agencies.
8. All labor shall be performed during regular working hours. Overtime premium will be charged to the buyer.
9. All genuine Wells replacement parts are warranted for ninety (90) days from date of purchase on non-warranty equipment. This parts warranty is limited only to replacement of the defective part(s). **Any use of non-genuine Wells parts completely voids any warranty.**
10. Installation, labor, and job check-outs are **not** considered warranty and are thus **not** covered by this warranty.
11. Charges incurred by delays, waiting time or operating restrictions that hinder the service technician's ability to perform service are **not** covered by warranty. This includes institutional and correctional facilities.

## SHIPPING DAMAGE CLAIM PROCEDURE

**NOTE:** For your protection, please note that equipment in this shipment was carefully inspected and packaged by skilled personnel before leaving the factory. Upon acceptance of this shipment, the transportation company assumes full responsibility for its safe delivery.

### IF SHIPMENT ARRIVES DAMAGED:

1. **VISIBLE LOSS OR DAMAGE:** Be certain that any visible loss or damage is noted on the freight bill or express receipt, and that the note of loss or damage is signed by the delivery person.
2. **FILE CLAIM FOR DAMAGE IMMEDIATELY:** Regardless of the extent of the damage.

3. **CONCEALED LOSS OR DAMAGE:** if damage is unnoticed until the merchandise is unpacked, notify the transportation company or carrier immediately, and file "CONCEALED DAMAGE" claim with them. This should be done within fifteen (15) days from the date the delivery was made to you. Be sure to retain the container for inspection.

Wells Bloomfield cannot assume liability for damage or loss incurred in transit. We will, however, at your request, supply you with the necessary documents to support your claim.

## TABLE OF CONTENTS

WARRANTY	xi
INTRODUCTION & SPECIFICATIONS	1
FEATURES & OPERATING CONTROLS	2
PRECAUTIONS & GENERAL INFORMATION	3
AGENCY LISTING INFORMATION	4
INSTALLATION	5, 6, 7
OPERATION	8
CLEANING INSTRUCTIONS	9
MAINTENANCE INSTRUCTIONS	10, 11
OPERATING INSTRUCTIONS	12, 13
TROUBLESHOOTING SUGGESTIONS	14
WIRING AND REFR. DIAGRAMS	15
BLANK PAGE FOR NOTES	16
ACCESSORY PARTS & SERVICE DATA	17

## INTRODUCTION

Thank you for purchasing this Wells Bloomfield appliance.

Proper installation, professional operation and consistent maintenance of this appliance will ensure that it gives you the very best performance and a long, economical service life.

This manual contains the information needed to properly install this appliance, and to use and care for the appliance in a manner which will ensure its optimum performance.

## ELECTRICAL & REFRIGERATION SPECIFICATIONS

MODELS	HP	AMPS 120VAC 1 $\phi$				REFRIGERANT		PRESSURE (psig)		POWER SUPPLY CORD
		TOTAL	MCA	MFS	LRA	TYPE	AMT.	HIGH	LOW	
RCP-100, RCP-200, RCP-300 RCP-7100, RCP-7200 RCP-100ST, RCP200ST, RCP300ST RCP-7100ST, RCP7200ST	1/4	5.5	8	15	38	R-134a	28 oz.	440	162	NEMA 5-15P
RCP-400, RCP-7300, RCP-400ST RCP-7300ST	1/3	7.0	11	15	29	R-404a	24 oz.	500	174	NEMA 5-15P
RCP-500, RCP-600, RCP-500ST, RCP-600ST, RCP-7400, RCP-7400ST	1/2	7.5	12	15	33	R-404a	32 oz.	500	174	NEMA 5-15P
RCP-7500, RCP-7500ST RCP-7600, RCP-7600ST	3/4	15.3	21	30	59	R-404a	54 oz.	500	174	NEMA 5-20P



## FEATURES & OPERATING CONTROLS

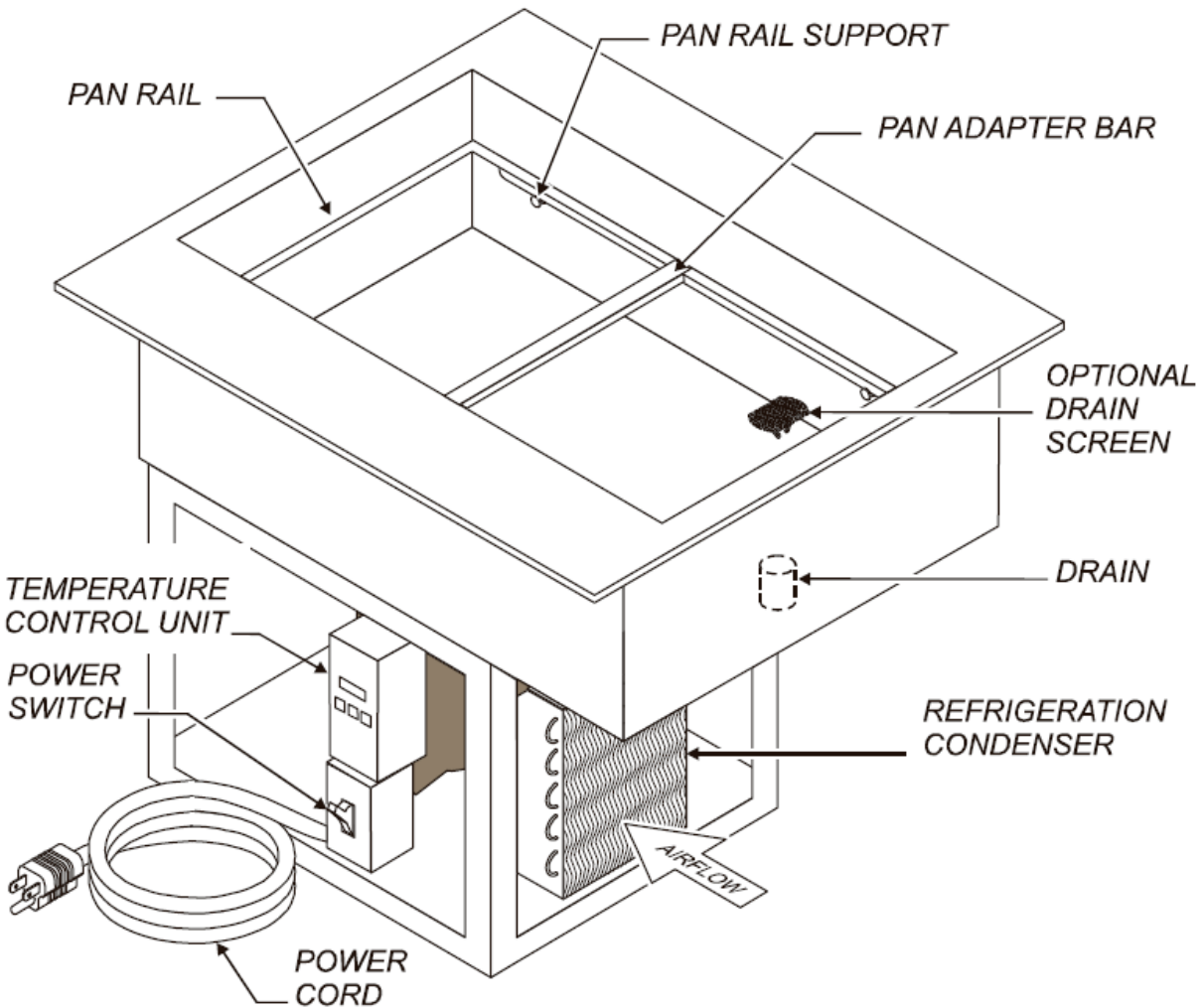

**NOTE:**

This is a general arrangement drawing only. Actual component positions may vary between units.



## PRECAUTIONS AND GENERAL INFORMATION

This appliance is intended for use in commercial establishments only, and is intended to hold pre-chilled prepared food for human consumption. No other use is recommended or authorized by the manufacturer or its agents.

Operators of this appliance must be familiar with the appliance use, limitations and associated restrictions. Operating instructions must be read and understood by all persons using or installing this appliance.

Food must be kept in appropriate inserts. Never place food directly into the tank.

Cleanliness of this appliance is essential to good sanitation. Read and follow all included cleaning instructions and schedules to ensure the safety of the food product.

Disconnect this appliance from electrical power before performing any maintenance or servicing.

This appliance is not jet stream approved. Do not direct water jet or steam jet at this appliance, or at any control panel or wiring. Do not splash or pour water on, in or over any controls, control panel or wiring. Do not wash floor around this appliance with water or steam jet.

The technical content of this manual, including any wiring diagrams, schematics, parts breakdown illustrations and/or adjustment procedures, is intended for use by qualified technical personnel.

Any procedure which requires the use of tools must be performed by a qualified technician.

This manual is considered to be a permanent part of the appliance. This manual and all supplied instructions, diagrams, schematics, parts breakdown illustrations, notices and labels must remain with the appliance if it is sold or moved to another location.

This appliance is made in the USA. Unless otherwise noted, this appliance uses all American-sized hardware.



### **WARNING: ELECTRIC SHOCK HAZARD**

All servicing requiring access to non-insulated electrical components must be performed by a factory authorized technician.

DO NOT open any access panel which requires the use of tools. Failure to follow this warning can result in severe electrical shock.



### **CAUTION: RISK OF DAMAGE**

DO NOT connect or energize this appliance until all installation instructions are read and followed. Damage to the appliance will result if the instructions are not followed.

## AGENCY LISTING INFORMATION



STD 2  
STD 7

This appliance performance tested to NSF Standard 7 for storage of potentially hazardous foods. This appliance meets NSF Standard 7 only when pan rails are installed in the lowest position, otherwise it meets NSF Standard 2.



RCP units are ETL listed for US and Canada

RCP units are evaluated to UL standard 471.



UL471

Components used in the manufacture of this unit are Underwriters Laboratory recognized.



## UNPACKING & INSPECTION

Carefully remove the appliance from the carton. Remove all protective plastic film, packing materials and accessories from the Appliance before connecting electrical power or otherwise performing any installation procedure.

Carefully read all instructions in this manual and the *Installation Instruction Sheet* packed with the appliance before starting any installation.

Read and understand all labels and diagrams attached to the appliance.

Carefully account for all components and accessories before discarding packing materials. Store all accessories in a convenient place for later use.

RCP units must remain upright at all times (shipping and installation) to prevent damage to the condensing unit. If the unit is accidentally tipped, allow unit to sit upright for at least 24 hours before connecting to electric power.

## COMPONENTS

- 1 ea. PAN RAIL
- 1 - 5 ea. PAN ADAPTER BAR ( quantity differs with unit)

## PREPARATION

Cutout dimensions for tank units and control panels are listed on the *Installation Instructions* provided with the unit.

Provide at least 1" clearance around the condensing unit chassis.

Countertop must be flat and level before the unit is installed. After cutout is made, add stiffeners or bottom braces to counter as required to support unit weight.

### IMPORTANT:

***Refrigeration system is air cooled. Recommend louvered grills or equivalent openings front and rear, each with a minimum size of twice the surface area of the condenser, to provide adequate air circulation.***

**NOTE:** The condenser fan is provided with a fan guard. DO NOT remove the condenser fan guard.

Provide louvered grills and service access below control panel. Provide access to the POWER SWITCH and TEMPERATURE CONTROL UNIT located at the front of the condenser.

Verify that provided sealants are applied to the underside of the top flange prior to setting the unit into the cutout.

After installation, apply a thin bead of food-grade silicone sealant around the flange to seal it to the counter.

Avoid storing flammable or combustible materials in, on or near the appliance.

Clean the unit thoroughly after installation and before first use.

**NOTE:** DO NOT discard the carton or other packing materials until you have inspected the appliance for hidden damage and tested it for proper operation. Refer to *SHIPPING DAMAGE CLAIM PROCEDURE* on the inside front cover of this manual.



### WARNING: RISK OF PERSONAL INJURY

Installation procedures must be performed by a qualified technician with full knowledge of all applicable electrical and plumbing codes. Failure can result in personal injury and property damage.

### IMPORTANT:

Unit must remain in an upright position during installation to prevent damage to the refrigeration system.

### IMPORTANT:

Refrigeration system is air cooled. Recommend louvered grills or equivalent openings front and rear, each with a minimum size of twice the surface area of the condenser, to provide adequate air circulation.

### IMPORTANT:

Access is required for the operation of the drain valve and for maintenance of the refrigeration unit. Provide adequate access to the drain valve and refrigeration unit.

### IMPORTANT:

Unit flange must be sealed to the counter top. Damage caused by leaks due to improper installation is NOT covered by warranty.

## INSTALLATION



### **WARNING:** **ELECTRIC** **SHOCK HAZARD**

All servicing requiring access to non-insulated electrical components must be performed by a factory authorized technician. DO NOT open any access panel which requires the use of tools. Failure to follow this warning can result in severe electrical shock.



### **CAUTION:** **RISK OF** **DAMAGE**

DO NOT connect or energize this appliance until all installation instructions are read and followed. Damage to the appliance will result if these instructions are not followed.



### **CAUTION:** **ELECTRIC** **SHOCK HAZARD**

Cord-connected units are equipped with a three-prong plug for your protection against electric shock. Never cut the large round prong from the plug, or twist a blade to fit an existing receptacle.

### **IMPORTANT:**

Contact a licensed electrician to install the correct circuit and receptacle (cord-connected units) or to install and connect electric power (field-wired units).

### **IMPORTANT:**

Damage due to being connected to the wrong voltage or phase is NOT covered by warranty.

## ELECTRICAL INSTALLATION

1. Refer to the nameplate. Verify the electrical service power. Voltage and phase must match the nameplate specifications. Wiring the unit to the wrong voltage can severely damage the unit, or cause a significant decrease in performance.
2. Available electrical amperage must meet or exceed the specifications listed on the specifications sheet provided with the unit.
  - a. Units are equipped with a three-prong (grounding) plug for your protection against electrical shocks. This must be plugged into a properly grounded matching receptacle.
  - b. RCP-100 through RCP-600 and RCP-7100 through RCP-7400 are equipped with a NEMA 5-15P plug and require a matching NEMA 5-15R receptacle.

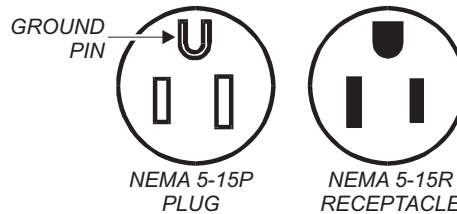

- c. RCP-7500 and RCP-7600 are equipped with a NEMA 5-20P plug and require a matching NEMA 5-20R receptacle.

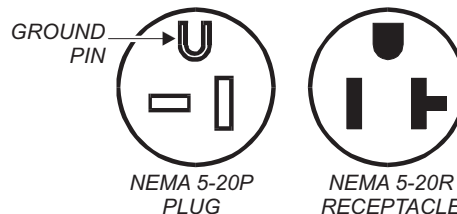

## INSTALLATION

### PLUMBING INSTALLATION

Install 1" drain valve (provided by others) on unit drain. Plumb to an appropriate waste as required by local plumbing and sanitation ordinances. Consult local codes for approved drain configurations.

#### IMPORTANT:

DO NOT allow the sink drain spud to turn during installation. Hold the spud with an appropriate cross-guard-style spud wrench, or carefully grip the center threaded portion with a strap wrench or slip-joint pliers to immobilize the drain spud during drain fitting installation. DO NOT grip the drain spud nut or gasket.

#### IMPORTANT:

Plumbing connections must be made in compliance with all Federal, State and Local Codes and Ordinances.

#### IMPORTANT:

All drain plumbing installations must be performed by a qualified plumber.

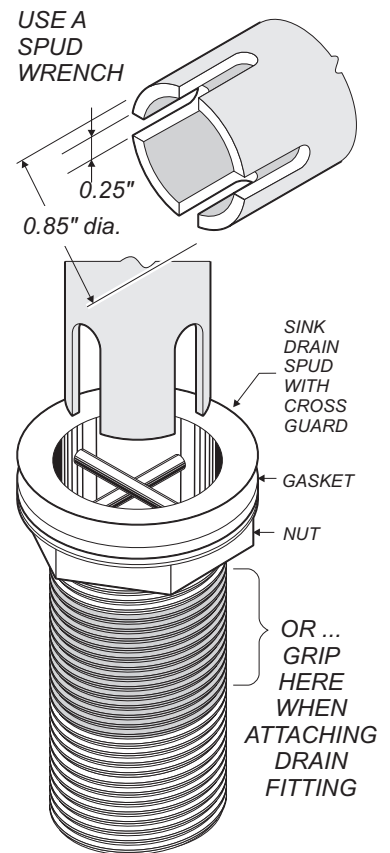

## OPERATION



### **CAUTION: ELECTRIC SHOCK HAZARD**

DO NOT splash or pour water onto control panel or wiring.

RCP units are designed to hold REFRIGERATED PRE-CHILLED product at serving temperature.

RCP units should not be used to chill product, nor to hold product for long term storage.

### **OPERATION NOTES**

1. Never place food directly in cold tank. Always use insets or food pans.
2. Use only *pre-chilled* products. Stir product occasionally to maintain an even temperature.
3. Use perforated bottom strainer plates when operating units with ice. Perforated bottom strainer plates are optional and must be ordered separately.
4. Models RCP-7100(ST) thru RCP-7600(st) are NSF-7 listed for use with potentially hazardous foods.
5. Periodically clean condensing coils to remove accumulated dust and debris. Failure to clean coils will decrease performance and may void the warranty.  
See *CONDENSER CLEANING*, page 8.

### **DAILY START-UP**

1. Turn POWER SWITCH (located on condensing unit) *ON*. Allow unit to run for approximately 30 minutes to reach operating temperature.
2. Add necessary adapter bars or adapter plates. Adapter bars provided with the unit are designed to hold 12" x 20" food pans up to 6" deep.
3. Install appropriate food pans or insets. Place pre-chilled product in food pans.

### **DAILY SHUT-DOWN**

1. Turn POWER SWITCH *OFF*. Remove product, food pans and adapters.
2. Allow unit to defrost before cleaning.  
See *CLEANING INSTRUCTIONS*, page 7.

## CLEANING INSTRUCTIONS

**PREPARATIONS:** Turn **POWER SWITCH OFF**. Unplug unit or disconnect from electric power.  
Allow unit to defrost before proceeding.  
Remove any insets, pans and/or adapter tops ( if used). Drain water from tank.

**FREQUENCY:** Daily

**TOOLS:** Warm Water and Mild Detergent  
Solution: 10 Parts Warm Water to 4 Parts Vinegar  
Plastic Scouring Pad  
Clean Cloth or Sponge  
Food-Grade Silicone Sealant



**CAUTION:  
ELECTRIC SHOCK  
HAZARD**

DO NOT splash or pour water onto control panel or wiring.

**IMPORTANT: DO NOT use steel wool for cleaning**

1. Remove pan adapter bars, pan rail and drain screen. Wipe interior of tank using a clean cloth or sponge and mild detergent.
2. Use a plastic scouring pad to remove any mineral deposits.
3. Rinse tank thoroughly with a vinegar and water solution to neutralize all detergent / cleanser residue.
4. Clean pan adapter bars and pan rail with a cloth or sponge dampened in clean water. Dry thoroughly, then reinstall.
5. Check drain screen, clean if necessary and reinstall.
6. Periodically inspect warmer flange-to-counter seal. Reseal with food-grade silicone sealant if necessary.
7. Inspect condenser. Clean if required.
8. Inspect cooling louvers in counter. Remove any lint or debris.
9. Reconnect to electric power. Turn **POWER SWITCH ON** only when unit is to be used.

Procedure is complete

## MAINTENANCE INSTRUCTIONS



### **CAUTION: PERSONAL INJURY HAZARD**

Disconnect appliance from electrical power before cleaning condenser coil.



### **CAUTION: PERSONAL INJURY HAZARD**

Condenser coil fins are sharp. Use care to avoid cuts while cleaning the condenser.

## CONDENSER COIL CLEANING INSTRUCTIONS

The condenser coil must be kept clean to allow adequate air flow for proper heat dissipation. Recommend this procedure be performed monthly.

1. Turn **POWER SWITCH OFF**. Disconnect unit from electrical power.
2. Remove louvers or access panel to allow coil to be reached.
3. Using a stiff bristle brush, brush lint and debris from the condenser fins. Brush vertically, top to bottom. Collect and discard all lint and debris gathered from this operation

**IMPORTANT:** The fins of the condenser coil are delicate and easily damaged. Use care to brush only in a vertical motion to avoid damaging the coil fins.

4. Wipe the fan blades to remove accumulated lint.
5. Reconnect to electrical power. Test for proper operation.

## MAINTENANCE INSTRUCTIONS

### CARE OF STAINLESS STEEL

1. The surface can be damaged by mechanical abrasion, hard water deposits and chlorine:
  - a. **NEVER** use steel wool, wire brushes or metal scrapers to clean the appliance. These will damage the surface.
  - b. Hard water deposits left behind when water is evaporated will attack the surface and allow the stainless steel to rust.
  - c. Chlorides from chlorinated cleansers, calcium / lime / rust removers (e.g. muriatic acid), even heavily chlorinated city water will attack the surface and allow the stainless steel to rust.
  - d. **DO NOT** use any highly caustic cleaners. Use of highly caustic cleaners will damage the surface.
    - a. **LIMIT USE** of strong caustic cleaners on warmers. Rinse thoroughly with a vinegar and water solution to neutralize any residue. Failure to do so may cause damage to the surface and allow the stainless steel to rust.
    - e. Cleansers containing ammonia will attack the surface and allow the stainless steel to rust.
2. Use the proper tools in the proper way to clean your Wells cold pan:
  - a. Soft cloth and plastic scouring pads are safe to use on stainless steel surfaces.
  - b. Stainless steel pads may be used **ONLY IF** the scrubbing motion is in the direction of the visible grain. **DO NOT** use a circular motion.
  - c. In the absence of visible grain, use only soft cloth or plastic pads. Scrub only in a linear motion along the longest axis of the equipment.
4. Use only non-chloride and non-ammonia cleansers:
  - a. **DO NOT** use any cleanser listed as "chlorinated".
  - b. **DO NOT** use any cleanser listing "ammonia" or "ammonium" in its contents.
  - c. Contact your cleaning materials supplier for suitable alkaline cleansers.
5. Keep your Wells cold pan clean. Clean frequently to avoid build-up of hard, stubborn stains and hard-to-remove deposits:
  - a. Rinse thoroughly with a vinegar and water solution to neutralize any residue.
  - b. For discoloration caused by using the warmer in dry operation, use a cleaner made specifically for stainless steel.
  - c. Wipe dry with a soft, clean, dry cloth.
  - d. Restore the surface by using a polishing product specifically made for stainless steel after each cleaning.



### CAUTION: PERSONAL INJURY HAZARD

Disconnect appliance from electrical power before cleaning.

Wells refrigerated cold pans are constructed of high quality stainless steel. As long as the stainless steel surface is intact, the equipment will not rust or corrode.

Recommendation:  
A water softening device or a cartridge-type filtration device may be used to minimize lime and calcium build-up.

## OPERATING INSTRUCTIONS

### IMPORTANT:

DO NOT adjust the differential settings of the refrigeration system. Field adjustments of the differential settings must be made by qualified refrigeration personnel only. Unauthorized adjustment of the differential settings will void the warranty.

The temperature setting of the NSF-7 Refrigerated Cold Pan has been pre-set at the factory to meet most applications. An electronic temperature control maintains food temperature between 33°F and 44°F.

## TEMPERATURE ADJUSTMENT

### RCP-100(ST) thru RCP-600(ST)

1. The temperature has been preset at the factory to meet most applications.
2. If temperature adjustments are required, the pressure switch, located on the condensing unit, is adjustable. Temperature adjustment must be performed by a qualified refrigeration personnel only.
3. Normal temperature setting would be 28°F.

### RCP-7100(ST) thru RCP-7600(ST)

The LCD Display provides a readout of the sensor temperature during normal operation. Use the following to change the setpoint temperature:

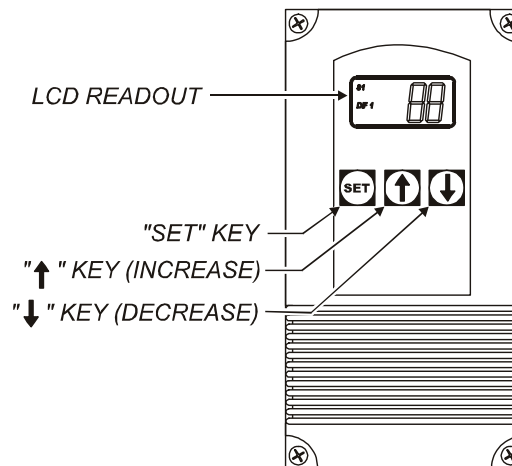

1. To start programming, press **SET** key once. This will access the Fahrenheit/Celsius mode. The readout will show the current status, either **F** (degrees Fahrenheit) or **C** (degrees Celsius). Press either "up arrow" (↑) or "down arrow" (↓) to toggle between **F** and **C** designation.
2. Press **SET** again to access the setpoint. The LCD will display the current setpoint, and the S1 annunciator will blink off and on to indicate that control is in the setpoint mode. Press either "up arrow" (↑) to increase the setpoint, or "down arrow" (↓) to decrease the setpoint to the desired temperature. Factory setpoint is 21°F.

## OPERATING INSTRUCTIONS

3. Press the **SET** key again to access the differential. The LCD will display the current differential, and the DIF1 annunciator will blink off and on to indicate that control is in the differential mode.

**IMPORTANT:** DO NOT adjust the differential settings of the refrigeration system. Field adjustments of the differential settings must be made by qualified refrigeration personnel only. Unauthorized adjustment of the differential settings will void the warranty.

Press either "up arrow" (↑) to increase the differential, or "down arrow" (↓) to decrease the differential to the desired setting. Factory differential is 3°F.

4. Press the **SET** key again to access the Heating / Cooling mode. The LCD will display the current mode. Either "C1" for cooling or "H1" for heating. The control must be set to C1 for proper operation of the cold pan.
5. Press the **SET** key again to complete programming. Programming ends automatically if no keys are pressed for 30 seconds. Any settings that have been input to the control will be accepted at that time.
6. Control settings are stored in non-volatile memory. Loss of power to the unit will not require reprogramming.

### **IMPORTANT:**

DO NOT adjust the differential settings of the refrigeration system. Field adjustments of the differential settings must be made by qualified refrigeration personnel only. Unauthorized adjustment of the differential settings will void the warranty.

### **NOTE:**

The controller has both "heating" and "cooling" modes. Heating mode is not used on the RCP-series units. The control must be set to "cooling" (C1) for proper operation of the cold pan.

## TROUBLESHOOTING

SYMPTOM	POSSIBLE CAUSE	REMEDY
No power to unit	Circuit breaker tripped	Reset circuit breaker
	Power switch OFF	Turn power switch ON
Food not kept cold enough	Food not chilled to start	Add only pre-chilled food
	Food too thick	Stir thick food frequently
	Setpoint too high	Set to desired temperature
	Condenser cooling louvers or coil plugged	Clean condenser louvers and/or coil
	Refrigerant level low	Contact Authorized Wells Service Agency for repairs
	Internal damage	Contact Authorized Wells Service Agency for repairs
	NSF-7 operation using wrong rail position	For holding critical foods, pan rails must be assembled using the lower pan rail supports. Also, pans can be no deeper than 4".

# WIRING AND REFRIGERATION SCHEMATICS

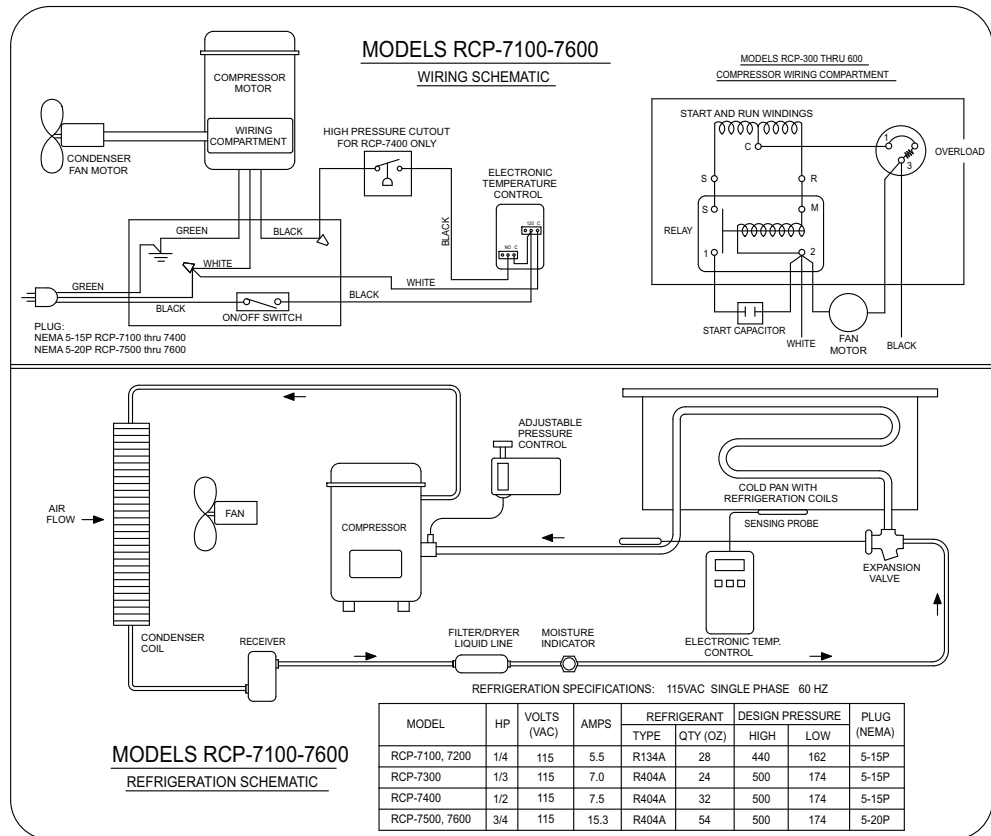
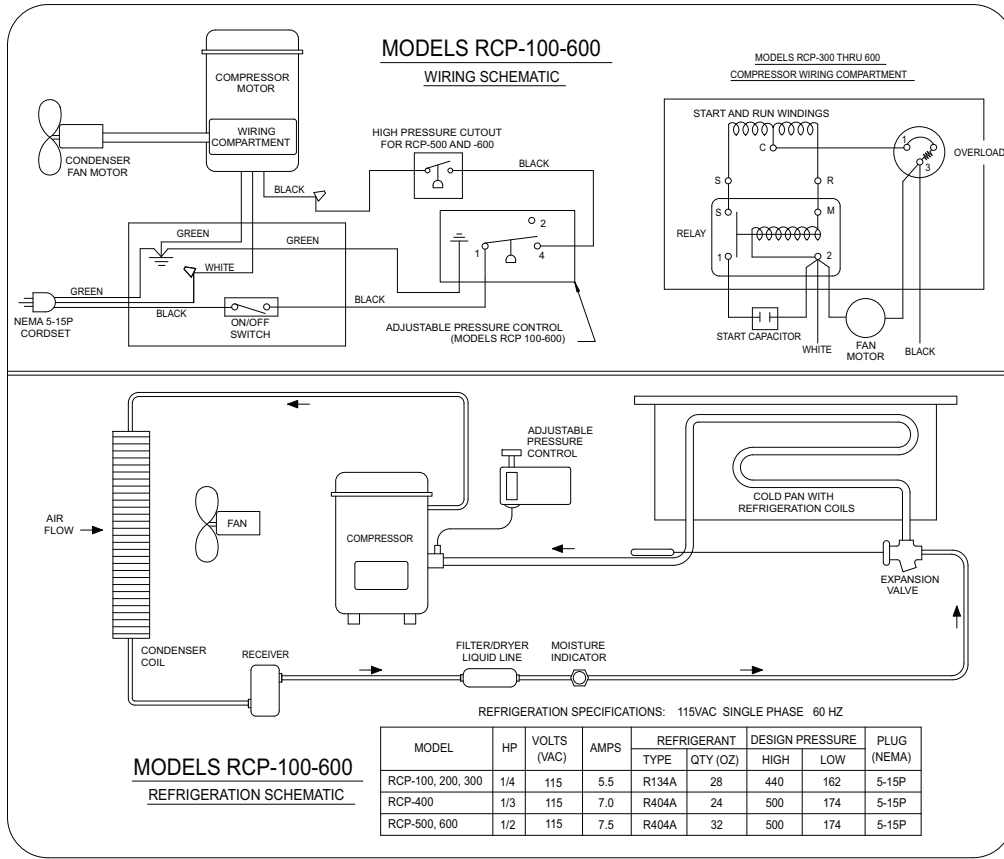

M405 p/n 2M-305101 Owners Manual Drop-In Refrigerated Cold Pans



**NOTES:**



## ACCESSORY PARTS & SERVICE

### DESCRIPTION

### PART NO.

DRAIN SCREEN	P2-31869
ADAPTER BAR FOR 12" X 20" PANS	O3-303100
PERFORATED BOTTOM PLATE STRAINER FOR RCP-100 (1 PC)	M2-22107
PERFORATED BOTTOM PLATE STRAINER FOR RCP-200 (1 PC)	5O-22108
PERFORATED BOTTOM PLATE STRAINER FOR RCP-300 (2 PC)	5O-22109
PERFORATED BOTTOM PLATE STRAINER FOR RCP-400 (2 PC)	5O-22110
PERFORATED BOTTOM PLATE STRAINER FOR RCP-500 (2 PC)	5O-22111
PERFORATED BOTTOM PLATE STRAINER FOR RCP-600 (3 PC)	5O-22112
PAN RAIL FOR RCP-7100	5O-22696
PAN RAIL FOR RCP-7200	5O-22697
PAN RAIL FOR RCP-7300	5O-22698
PAN RAIL FOR RCP-7400	5O-22699
PAN RAIL FOR RCP-7500	5O-22700
PAN RAIL FOR RCP-7600	5O-22701

**IMPORTANT: Use only factory authorized service parts and replacement filters.**

For factory authorized service, or to order factory authorized replacement parts, contact your Wells authorized service agency, or call:

**Wells Bloomfield, LLC**

10 Sunnen Dr.,  
St. Louis MO 63143 USA

**Service Dept.**

phone: (314) 678-6314  
fax: (314) 781-2714

Service Parts Department can supply you with the name and telephone number of the **WELLS AUTHORIZED SERVICE AGENCY** nearest you.

### CUSTOMER SERVICE DATA

please have this information available if calling for service

RESTAURANT \_\_\_\_\_ LOCATION \_\_\_\_\_  
 INSTALLATION DATE \_\_\_\_\_ TECHNICIAN \_\_\_\_\_  
 SERVICE COMPANY \_\_\_\_\_  
 ADDRESS \_\_\_\_\_ STATE \_\_\_\_\_ ZIP \_\_\_\_\_  
 TELEPHONE NUMBER (\_\_\_\_) \_\_\_\_\_ - \_\_\_\_\_

EQUIPMENT MODEL NO. \_\_\_\_\_  
 EQUIPMENT SERIAL NO. \_\_\_\_\_  
 VOLTAGE: (check one)  120  \_\_\_\_\_





Wells Bloomfield proudly supports CFESA  
Commercial Food Equipment Service Association

**SERVICE TRAINING - QUALITY SERVICE**



**CUSTOMER SATISFACTION**



**WELLS BLOOMFIELD, LLC**  
10 Sunnen Dr., St. Louis, MO 63143  
telephone: 314-678-6314  
fax: 314-781-2714  
[www.wellsbloomfield.com](http://www.wellsbloomfield.com)