

# DENON<sup>®</sup>

## DHT-S316

HOME THEATER SYSTEM

# Owner's Manual



<b>Accessories</b>	<b>4</b>
Inserting the batteries	5
Operating range of the remote control unit	5
<b>Features</b>	<b>6</b>
<b>Part names and functions</b>	<b>7</b>
Sound bar	7
Subwoofer	10
Remote control unit	11

## Connections

<b>Positioning</b>	<b>12</b>
Positioning the sound bar	12
Positioning the subwoofer	14
<b>Connecting a TV</b>	<b>15</b>
Connection 1: TV equipped with an HDMI connector and compatible with the ARC (Audio Return Channel)	16
Connection 2: TV equipped with an HDMI connector and incompatible with the ARC / TV equipped with an optical digital connector	17
Connection 3: TV equipped with an HDMI connector and incompatible with the ARC / TV equipped with an analog connector	18
<b>Connecting the power cords</b>	<b>19</b>

## Playback

<b>Enjoying television, movies and music</b>	<b>20</b>
Status LED table	21
<b>Listening to music on a Bluetooth device</b>	<b>22</b>
Pairing a Bluetooth device for the first time	22
Pairing with other Bluetooth devices	23
Listening to music with a paired Bluetooth device	23

## Settings

<b>Settings</b>	<b>24</b>
Adjusting the volume	24
Adjusting the subwoofer volume	24
Selecting a listening mode	25
Turning off the sound temporarily	25
Setting the Bluetooth standby function	25
Auto standby function	26
Volume limiter function	26



## Tips

<b>Troubleshooting</b>	<b>27</b>
Power does not turn on / Power is turned off	28
Operations cannot be performed through the remote control unit	28
No sound comes out	29
Bluetooth playback does not work	30
The HDMI Control function does not work	30
<b>Resetting factory settings</b>	<b>31</b>

## Appendix

<b>About HDMI</b>	<b>32</b>
<b>Trademark information</b>	<b>33</b>
<b>Specifications</b>	<b>34</b>
Sound bar	34
Subwoofer	37









Thank you for purchasing this Denon product.

To ensure proper operation, please read this owner's manual carefully before using the product.

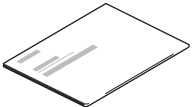
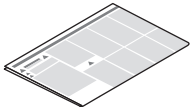
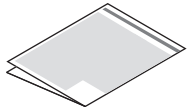
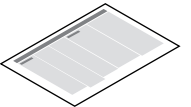
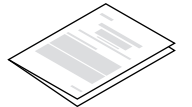
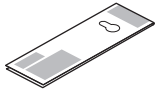
After reading this manual, be sure to keep it for future reference.

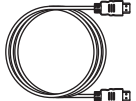
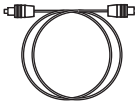
## Accessories

Check that the following parts are supplied with the product.

 <p>Quick Start Guide</p>	 <p>Safety Instructions</p>	 <p>Cautions on Using Batteries</p>	 <p>Notes on radio</p>	 <p>Warranty</p>
 <p>Wall mount template</p>	 <p>Power cords</p>	 <p>HDMI cable</p>	 <p>Optical digital cable</p>	 <p>Wall mount spacers</p>
 <p>Remote control unit (RC-1230)</p>	 <p>R03/AAA battery</p>			



## Inserting the batteries

- 1 Slide the rear cover off the remote control unit in the arrow direction.

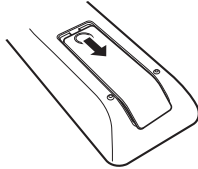

- 2 Insert 1 battery into the battery compartment as indicated.

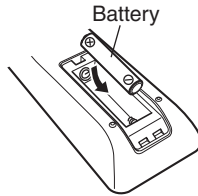

- 3 Put the rear cover back on.

### NOTE

- Remove the batteries from the remote control unit if it will not be in use for long periods.
- If the battery fluid should leak, carefully wipe the fluid off the inside of the battery compartment and insert new batteries.

## Operating range of the remote control unit

Point the remote control unit at the remote sensor when operating it.

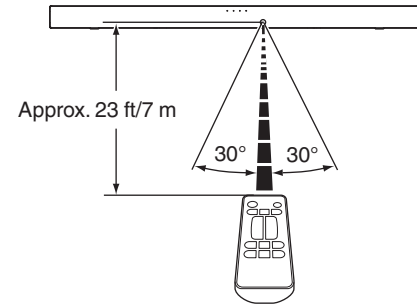

# Features

---

- **Two-way sound bar with wireless subwoofer: Powerful, dynamic Denon home theater sound**

**Easy Setup:** Quickly connect to your TV with the supplied HDMI or Optical cables.

**Wireless Subwoofer:** Powerful bass without the cables. Place the subwoofer within 30 ft of the sound bar for optimal enjoyment.

**2" Low-profile Design:** At 2" tall, the Denon DHT-S316 fits most spaces and can be placed in front of your TV without blocking your TV's bottom edge or IR remote sensor.

- **Exceptional sound clarity for your TV, Blu-ray, gaming system and favorite music sources**

**HDMI with Audio Return Channel:** Send audio from your TV's built-in apps, on-board tuner or HDMI connections over a single cable when you connect your TV's HDMI ARC output to the sound bar using the included HDMI cable.

**Digital Audio Optical Input:** Effortlessly connect your Blu-ray, gaming or other device with the included Optical cable.

**Analog Auxiliary Input:** Connect any source compatible with a 3.5 mm input and listen through the DHT-S316.

**Bluetooth:** Connect your smartphone or tablet to the DHT-S316 to wirelessly stream music and other audio.

- **Immerse yourself in a realistic home theater experience**

**Dolby Digital and DTS Decoding:** Virtual surround technology creates a powerful, realistic multi-channel home theater experience.

**Denon Dialogue Enhancer:** Never miss a word of your favorite TV show or movie, Denon Dialogue Enhancer improves dialogue intelligibility - ideal for movies and TV shows. Turn up the dialogue without having to adjust overall volume.



## Part names and functions

### Sound bar

#### ■ Top panel

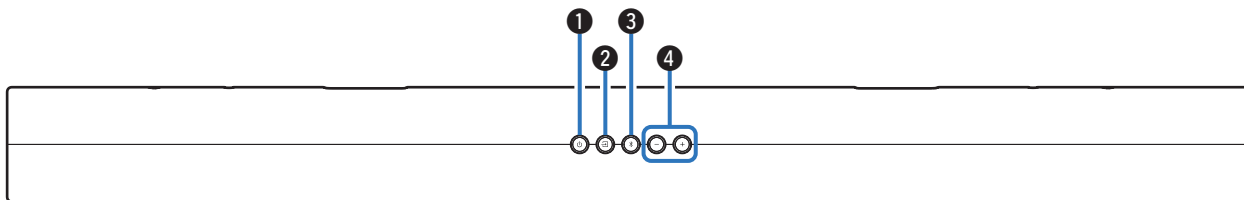

**1 Power operation button (⏻)**

Turns the sound bar power on/off (standby). (🔗 p. 20)

Links to sound bar power and turns the subwoofer power on/off (standby).

**2 Input source button (📺)**

This selects the input source. (🔗 p. 20)

Switches the input source each time the button is pressed.

**3 Bluetooth button (📶)**

- Switches the input source to “Bluetooth”. (🔗 p. 22)

- Used to pair with Bluetooth devices. (🔗 p. 22)

**4 Volume buttons (+, -)**

These adjust the volume level. (🔗 p. 24)



## ■ Front panel

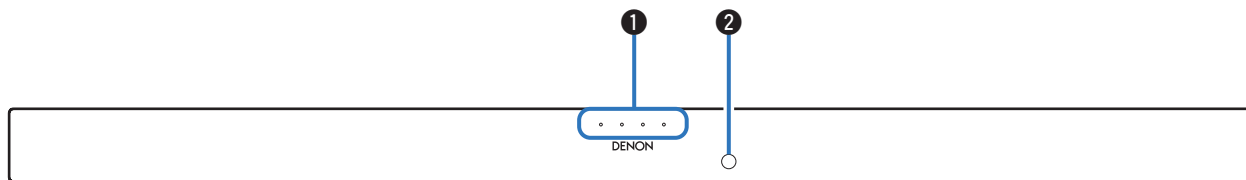

### ① Status LED

Displays the status of input source / input signal / listening mode, etc.  
([🔗 p. 21](#))

### ② Remote control sensor

This receives signals from the remote control unit. ([🔗 p. 5](#))

## ■ Bottom panel

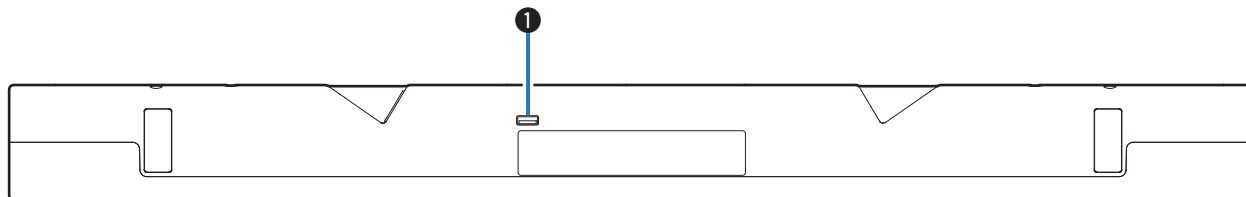

### ① USB port

Service terminal. Not used in normal operation.



## ■ Rear panel



### ❶ Wall hook hole

Used to mount the sound bar on a wall. (👉 p. 13)

### ❷ HDMI connector (TV (ARC))

Use the included HDMI cable to connect an ARC function-compatible TV. (👉 p. 16)

### ❸ AUX audio input connector

Use a commercially available 3.5 mm stereo audio cable to connect an audio device. (👉 p. 18)

### ❹ Optical digital input connector (TV OPTICAL)

Use the included optical digital cable to a TV with an optical digital terminal. (👉 p. 17)

### ❺ AC inlet

Used to connect the power cord. (👉 p. 19)



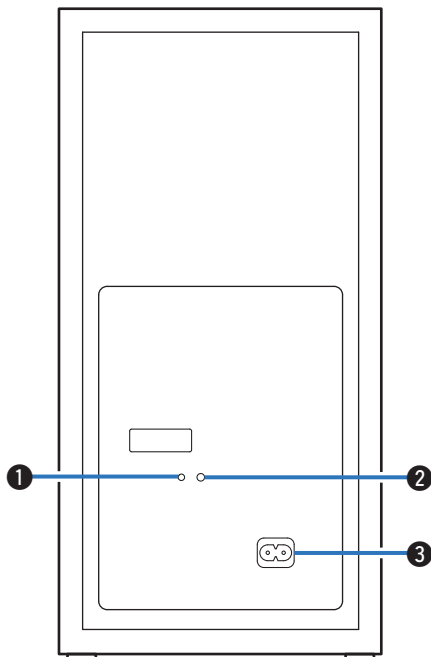

## Subwoofer

### ■ Rear panel



#### 1 Status LED

Displays subwoofer status.

LED indication	Status
○	When subwoofer power is on/off (standby)
 → 	When the sound bar and subwoofer are wirelessly connected



- The sound bar and subwoofer are wirelessly connected as the factory default. If no audio is output from the subwoofer, wirelessly connect the sound bar and subwoofer again. (🔗 p. 29)

#### 2 BAR SYNC button

Used to wirelessly connect the sound bar and subwoofer. (🔗 p. 29)

#### 3 AC inlet

Used to connect the power cord. (🔗 p. 19)



## Remote control unit

This section mainly explains remote control operations.

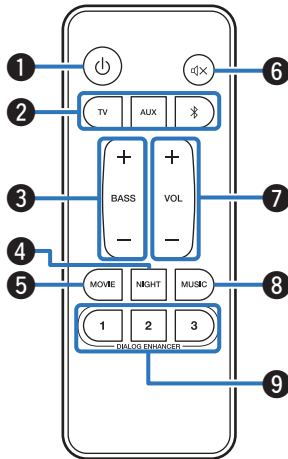

### 1 Power button (⏻)

Turns the sound bar power on/off. (🔗 p. 20)

Links to sound bar power and turns the subwoofer power on/off.

### 2 Input source buttons (TV, AUX, 📶)

This selects the input source. (🔗 p. 20)

### 3 Button to adjust subwoofer (BASS +, -)

Adjusts the volume level for the subwoofer. (🔗 p. 24)

### 4 Night mode button (NIGHT)

Compresses the dynamic range (difference between loud and soft sounds) to make audio easier to hear at low volumes. (🔗 p. 25)

### 5 Movie mode button (MOVIE)

Enjoy movie theater-like surround sound. (🔗 p. 25)

### 6 Mute button (⏻)

This mutes the output audio. Press again to unmute. (🔗 p. 25)

### 7 Volume buttons (VOL +, -)

These adjust the volume level. (🔗 p. 24)

### 8 Music mode button (MUSIC)

Enjoy the full presence of a wide, encompassing acoustic field. (🔗 p. 25)

### 9 Dialog enhancer buttons (DIALOG ENHANCER 1 - 3)

Adjust the volume of dialog in movies, vocals in music, etc. so these can be heard more easily. (🔗 p. 25)

Can be set to 3 levels. Set this to the desired value.



# Positioning

---

## Positioning the sound bar

Position the sound bar in front of your TV, etc., on a flat surface.

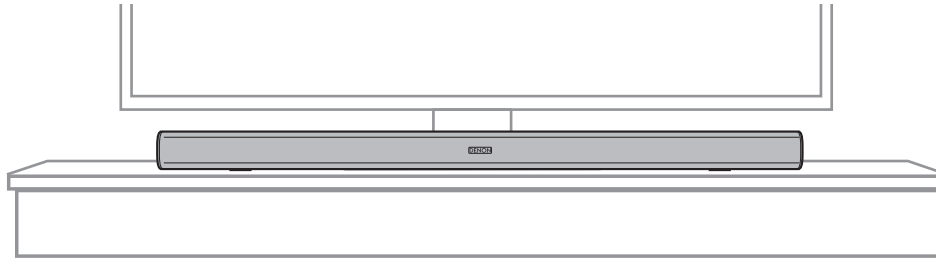

### NOTE

- When positioning the sound bar in front of your TV, make sure the sound bar does not obstruct the TV's remote control light sensor, etc.



## ■ When hanging the sound bar on a wall

The sound bar has a wall hook hole to hang it on a wall. When hanging it on a wall, position it in a flat, vertical position.



- When hanging it on a wall, use the included wall mount template.

[How to use the wall mount template]

- ① Affix the template to the location you would like to mount the sound bar.
- ② Screw in the wall mount screws by following the template.

Consult a construction professional about the proper wall mount screws for the material and strength of your wall.

- ③ Remove the template from the wall.
- ④ Mount the included wall mount spacer on the spine of the sound bar.  
Mounting the wall mount spacer creates a space for cords to pass through between the sound bar and the wall.
- ⑤ Mount the sound bar on the wall.

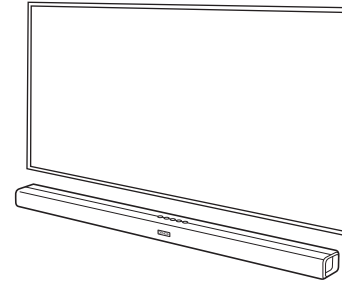

### NOTE

- To ensure safety, request a contractor perform the mounting work when mounting onto a wall.
- In order to use the unit safely, do not place items on or hang items from the unit.
- Be sure to fix connection cables to the wall to ensure that cannot be pulled or tripped over causing this unit to fall. Check that the unit is mounted safely after the mounting work is complete.
- Also, periodically check the safety of this unit and whether there is a possibility that the unit may fall.
- Denon cannot accept any responsibility for damage, injury or accidents caused by problems with the mounting location or mounting method.



## Positioning the subwoofer

Position the subwoofer in a flat location near the sound bar.

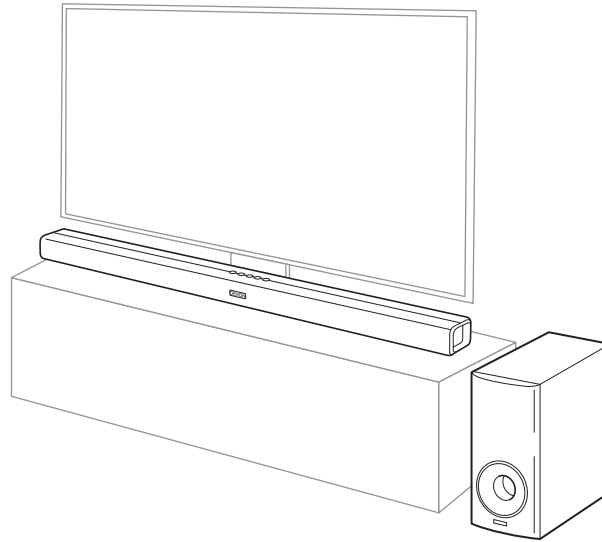

# Connecting a TV

---

How to connect a TV depends on the connectors and functions equipped on the TV.



- Enable the TV's HDMI control function when using an HDMI cable to connect this device to your TV. (See the TV Owner's Manual for details.)
- Turn off the TV's speaker or minimize the volume when using this device.
- HDMI cable connection is recommended, but connection can be performed without an HDMI cable.

## NOTE

- Make sure all devices are off when connecting.
- Do not plug device power cords into an outlet until all devices have been connected.



## Connection 1: TV equipped with an HDMI connector and compatible with the ARC (Audio Return Channel)

Use the included HDMI cable to connect this device to an ARC function-compatible TV.

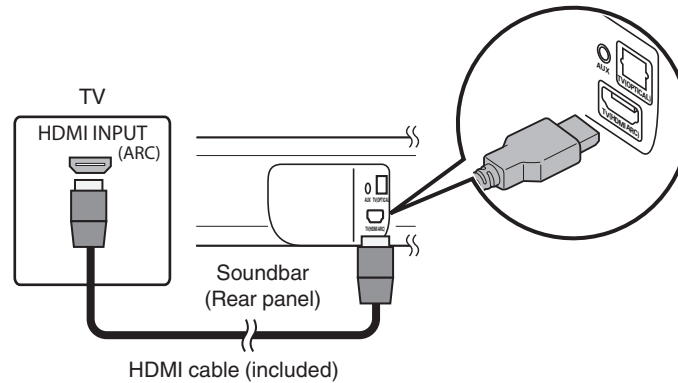

- The TV also needs to be compatible with the ARC function.



## Connection 2: TV equipped with an HDMI connector and incompatible with the ARC / TV equipped with an optical digital connector

Use the included HDMI and optical digital cables to connect this device to your TV.

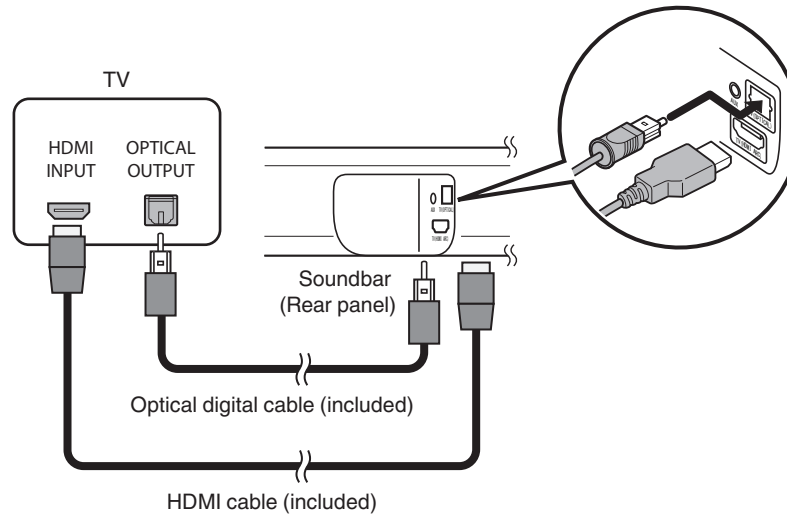

- Line up the optical digital cable with the shape of the terminal to insert.



## Connection 3: TV equipped with an HDMI connector and incompatible with the ARC / TV equipped with an analog connector

Use the included HDMI cable and a commercially available 3.5 mm stereo audio cable to connect this device to your TV.

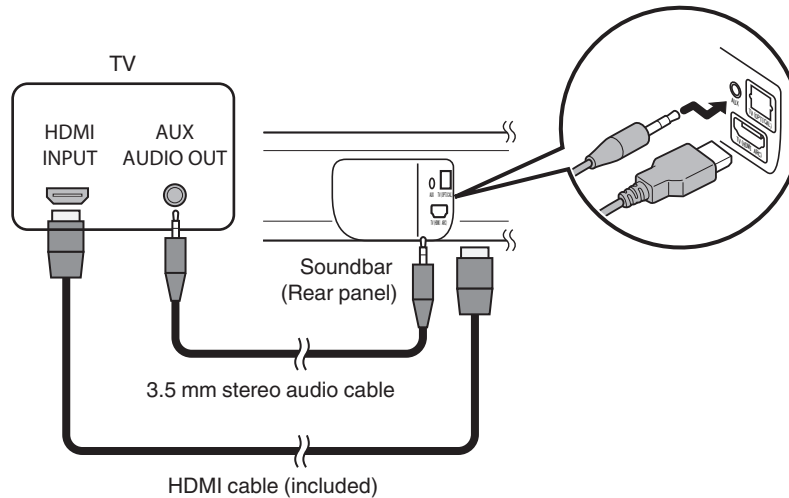

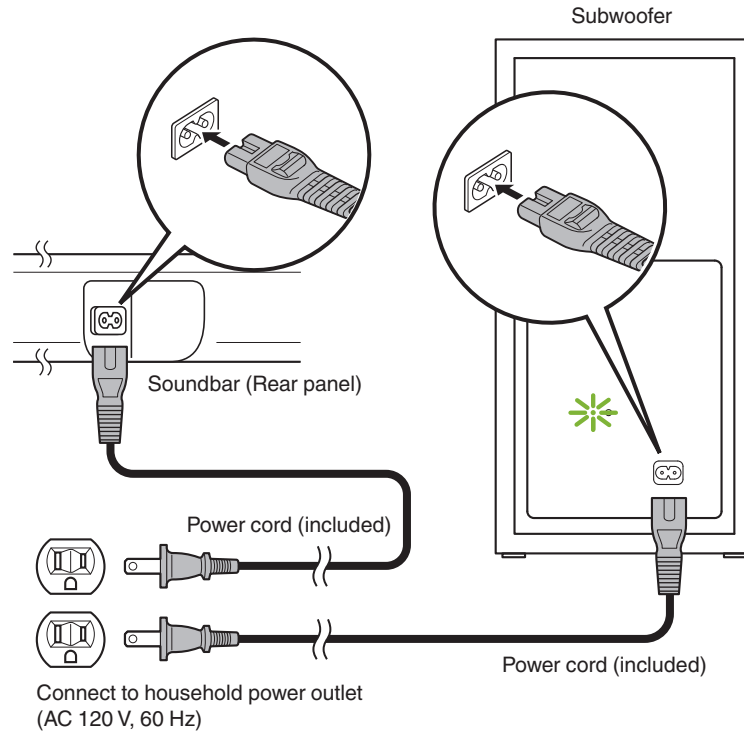

## Connecting the power cords

After completing all the connections, insert the power plug into the power outlet.

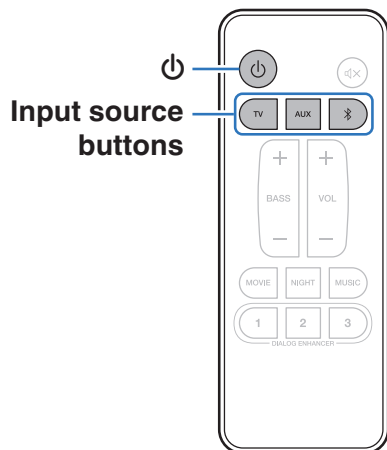

## Enjoying television, movies and music



- 1** Turn on the power of the TV and connected devices.
- 2** Press  to turn on power to the unit.
- 3** Press the input source button.
- 4** Play the device connected to this unit.  
For details, see the relevant device manual.



- Connect an HDMI control-compatible TV and this device via HDMI and enable the HDMI control to enable linked control from either device. ( [p. 32](#))



## Status LED table

Status LEDs change depending on the input source, input signal, etc.

LED indication	Status
	When power is off/standby
	During startup
	Input source: Bluetooth
	Input source: HDMI (ARC)
	Input source: OPTICAL
	Input source: ANALOG

LED indication	Status
	Input source: HDMI (ARC) Audio signal: PCM
	Input source: HDMI (ARC) Audio signal: Dolby
	Input source: HDMI (ARC) Audio signal: DTS
	Input source: OPTICAL Audio signal: PCM
	Input source: OPTICAL Audio signal: Dolby
	Input source: OPTICAL Audio signal: DTS



- Audio signal is not displayed when the input source is "Bluetooth".



## Listening to music on a Bluetooth device

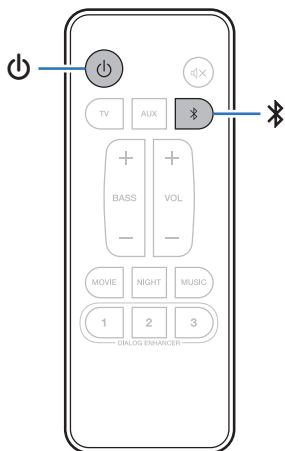

Music files stored on Bluetooth devices such as smartphones, digital music players, etc. can be enjoyed on this unit by pairing and connecting this unit with the Bluetooth device.



### Pairing a Bluetooth device for the first time

Pair a Bluetooth device with this unit.

Once the Bluetooth device has been paired, it does not need to be paired again.



- 1 Press  to turn on power to the unit.**
- 2 Press  to switch the input source to “Bluetooth”.**
- 3 Activate the Bluetooth settings on your Bluetooth device.**  
Switches to pairing mode the first time it is used.
- 4 Select “DHT-S316” from the list of devices displayed on the screen of the Bluetooth device.**  
Status display LED lights up in blue and this device and the Bluetooth device are paired.



- Pairing is canceled if the power cord is removed. Perform pairing again.



## Pairing with other Bluetooth devices



- 1 Press  to turn on power to the unit.
- 2 Press  to switch the input source to “Bluetooth”.
- 3 Activate the Bluetooth settings on your Bluetooth device.
- 4 Push  on this device until the status display LED blinks in blue.
- 5 Select “DHT-S316” from the list of devices displayed on the screen of the Bluetooth device.

Status display LED lights up in blue and this device and the Bluetooth device are paired.



- This unit can be paired with a maximum of 8 Bluetooth devices. When a 9th Bluetooth device is paired, it will be registered in place of the oldest registered device.
- Pairing is canceled if the power cord is removed. Perform pairing again.

## Listening to music with a paired Bluetooth device

- 1 Press  to turn on power to the unit.
- 2 Press  to switch the input source to “Bluetooth”.
- 3 Activate the Bluetooth settings on your Bluetooth device.
- 4 Press .  
The status display LED lights up in blue and connects to the last Bluetooth device connected. If the connection is cut, perform connection again.
- 5 Play music using any app on your Bluetooth device.



# Settings

Perform the below operations and settings as needed.

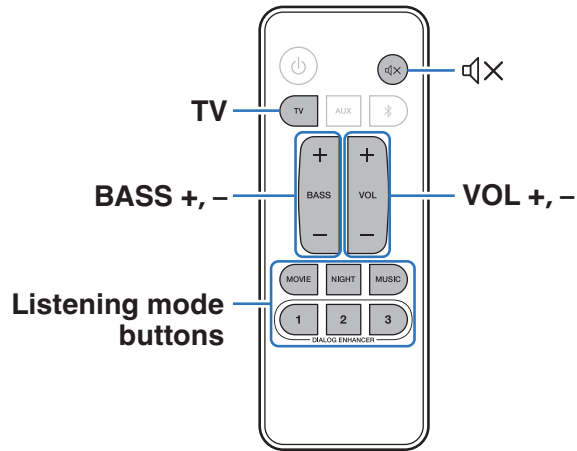

## Adjusting the volume

### 1 Use VOL + or VOL - to adjust the volume.

The selected input source LED blinks once every time the button is pushed.

## Adjusting the subwoofer volume

### 1 Use BASS + or BASS - to adjust the subwoofer volume.

The selected input source LED blinks once every time the button is pushed.



## Selecting a listening mode

### 1 Press the listening mode button to select a listening mode.

The status display LED blinks once in purple.





<b>MOVIE</b> (Default):	Enjoy movie theater-like surround sound.
<b>NIGHT:</b>	Compresses the dynamic range (difference between loud and soft sounds) to make audio easier to hear at low volumes.
<b>MUSIC:</b>	Enjoy the full presence of a wide, encompassing acoustic field.
<b>DIALOG ENHANCER</b> 1 - 3:	Adjust the volume of dialog in movies, vocals in music, etc. so these can be heard more easily. Can be set to 3 levels. Set this to the desired value.

## Setting the Bluetooth standby function

If Bluetooth standby function is set to “on”, this device automatically turns on when Bluetooth connects via the paired Bluetooth device.

In order to use this operation, the device needs to be paired with this unit in advance.

### 1 Press and hold TV for 5 seconds or more until the status display LEDs blink as indicated below.

LED indication	Status
 <input type="radio"/>  <input type="radio"/>	Bluetooth standby function: On
 <input type="radio"/>  <input type="radio"/>	Bluetooth standby function: Off (Default)

## Turning off the sound temporarily

### 1 Press .

The selected input source LED blinks.



- To cancel, press  again.



## Auto standby function

If no operations have been performed for 15 minutes or more and audio is not being output, this device automatically switches to standby.

## Volume limiter function

This device is loaded with a volume limiter function which limits excessive output. If volume is above 18 when the power is off, the volume is set to 18 the next time power is turned on.



# Troubleshooting

---

If a problem should arise, first check the following:

1. **Are the connections correct?**
2. **Is the set being operated as described in the owner's manual?**
3. **Are the other devices operating properly?**

If this unit does not operate properly, check the corresponding symptoms in this section.

If the symptoms do not match any of those described here, consult your dealer as it could be due to a fault in this unit. In this case, disconnect the power immediately and contact the store where you purchased this unit.



## Power does not turn on / Power is turned off

### Power does not turn on.

- Check whether the power plug is correctly inserted into the power outlet. (☞ p. 19)
- If you cannot turn on the unit with the TV's HDMI control function, press the ⏻ button to turn the unit's power or set the Bluetooth standby function to "On". (☞ p. 25)

### Power automatically turns off.

- If no operations have been performed for 15 minutes or more and audio is not being output, this device automatically switches to standby. (Auto standby function)

## Operations cannot be performed through the remote control unit

### Operations cannot be performed through the remote control unit.

- Batteries are worn out. Replace with new batteries. (☞ p. 5)
- Operate the remote control unit within a distance of about 23 ft/7 m from this unit and at an angle of within 30°. (☞ p. 5)
- Remove any obstacle between this unit and the remote control unit.
- Insert the batteries in the proper direction, checking the ⊕ and ⊖ marks. (☞ p. 5)
- The set's remote control sensor is exposed to strong light (direct sunlight, inverter type fluorescent bulb light, etc.). Move the set to a place in which the remote control sensor will not be exposed to strong light.



## No sound comes out

### No sound comes out.

- Check the connections for all devices. (🔗 p. 12)
- Insert connection cables all the way in.
- Check that input connectors and output connectors are not reversely connected.
- Check cables for damage.
- Check that a proper input source is selected. (🔗 p. 20)
- Adjust the volume. (🔗 p. 24)
- Make sure volume is not muted. (🔗 p. 25)

### No sound is produced from subwoofer.

- When there is an obstacle between the sound bar and the subwoofer, remove it or place the subwoofer closer to the sound bar.
- Make sure the subwoofer status display LED is lit in green. If lights are not lit, it may indicate that the sound bar and subwoofer are not wirelessly connected. Perform connection again according to the following steps.
  - ① Press the ⏻ button to turn on power to the unit.
  - ② Press and hold the subwoofer BAR SYNC button for 3 seconds or more.  
The subwoofer status display LED blinks once in green.
  - ③ Press and hold the sound bar ⌘ and + buttons for 5 seconds or more until the subwoofer status display LEDs blink as indicated below.  
The sound bar and subwoofer wirelessly connect. Perform steps ① to ③ again if they do not connect.



## Bluetooth playback does not work

### Cannot pair with a Bluetooth device.

- It may be that Bluetooth is not enabled on the Bluetooth device. See the Owner's Manual of the Bluetooth device to enable the Bluetooth function.
- This device may be paired with another Bluetooth device. Select this unit from the list of devices displayed on the screen of the Bluetooth device.
- Bring the Bluetooth device near to this unit.
- Turn the power of the Bluetooth device off and on again, and then try again.
- Only 1 Bluetooth device can be connected at a time.

### The sound is cut off.

- Bring the Bluetooth device near to this unit.
- Remove obstructions between the Bluetooth device and this unit.
- To prevent electromagnetic interference, locate this unit away from microwave ovens, wireless LAN devices and other Bluetooth devices.
- Pair with the Bluetooth device again. (👉 p. 22)

## The HDMI Control function does not work

### The HDMI Control function does not work.

- You cannot operate devices that are not compatible with the HDMI Control function. In addition, depending on the connected device or the settings, the HDMI Control function may not work. In this case, operate the external device directly.
- Check that the HDMI Control function setting is enabled on all devices connected to this unit.



## Resetting factory settings

Perform this procedure if the display is abnormal or if operations cannot be performed.

Various settings are reset to the factory default values. Make settings again.

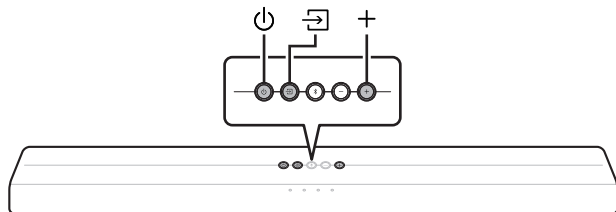

- 1 Press ⏻ to turn on power to the unit.**
- 2 Press and hold the main unit's ⏻, 🏠 and + at the same time for at least 5 seconds.**  
All status display LEDs blink 4 times.
- 3 Wait for around 10 seconds after the LED turns off and then press ⏻.**  
All settings return to the factory settings after the sound bar is restarted.



## About HDMI

---

This unit supports the following HDMI functions.

- **ARC (Audio Return Channel) function**

Enjoy movies, music, etc., on your TV simply by connecting an ARC function-compatible TV to this device via HDMI.

- **HDMI control function**

Connect an HDMI control-compatible TV and this device via HDMI and enable the HDMI control to enable linked control from either device.

- Input source switching

If the TV is turned on, this device automatically powers on and switches the input source.

- Power off link

The TV power off operation is linked so this device also turns off. (Does not work if input source is “OPTICAL” or “Bluetooth”.)

- Volume adjustment

The volume of this unit can be adjusted using the TV remote control.

- Audio output destination switching

If this unit is turned on, TV audio is output from this unit. If this device is turned off, TV audio is output from the speakers of the TV.

### NOTE

- Some functions may not operate depending on the connected TV. Check the owner's manual of each device for details beforehand.



## Trademark information



The Bluetooth® word mark and logos are registered trademarks owned by the Bluetooth SIG, Inc. and any use of such marks by D&M Holdings Inc. is under license. Other trademarks and trade names are those of their respective owners.



Manufactured under license from Dolby Laboratories. Dolby, Dolby Audio, and the double-D symbol are trademarks of Dolby Laboratories.



For DTS patents, see <http://patents.dts.com>. Manufactured under license from DTS, Inc. DTS, the Symbol, DTS and the Symbol together, and Digital Surround are registered trademarks and/or trademarks of DTS, Inc. in the United States and/or other countries. © DTS, Inc. All Rights Reserved.



The terms HDMI, HDMI High-Definition Multimedia Interface, and the HDMI Logo are trademarks or registered trademarks of HDMI Licensing Administrator, Inc.



# Specifications

---

## Sound bar

### ■ General

<b>Operating temperature:</b>	41 °F - 95 °F (5 °C - 35 °C)
<b>Power supply:</b>	AC 120 V, 60 Hz
<b>Power consumption:</b>	40 W
<b>Power consumption in standby mode:</b>	0.3 W
<b>Power consumption in Bluetooth standby:</b>	1.6 W
<b>Sampling frequency:</b>	32 kHz, 44.1 kHz, 48 kHz
<b>Supported audio formats:</b>	Linear PCM, Dolby Digital, DTS Digital Surround



## ■ Bluetooth section

<b>Communications system:</b>	Bluetooth Version 4.2
<b>Transmission power:</b>	Power Class 2
<b>Maximum communication range:</b>	Approx. 32.8 ft/10 m in line of sight*
<b>Used frequency range:</b>	2.4 GHz band
<b>Modulation scheme:</b>	FHSS (Frequency-Hopping Spread Spectrum)
<b>Supported profiles:</b>	A2DP (Advanced Audio Distribution Profile) 1.3 AVRCP (Audio Video Remote Control Profile) 1.6
<b>Corresponding codec:</b>	SBC
<b>Transmission range (A2DP):</b>	20 Hz – 20,000 Hz

\*The actual communication range varies depending on the influence of such factors as obstructions between devices, electromagnetic waves from microwave ovens, static electricity, cordless phones, reception sensitivity, antenna performance, operating system, application software etc.



## ■ Dimensions (Unit : in. (mm))

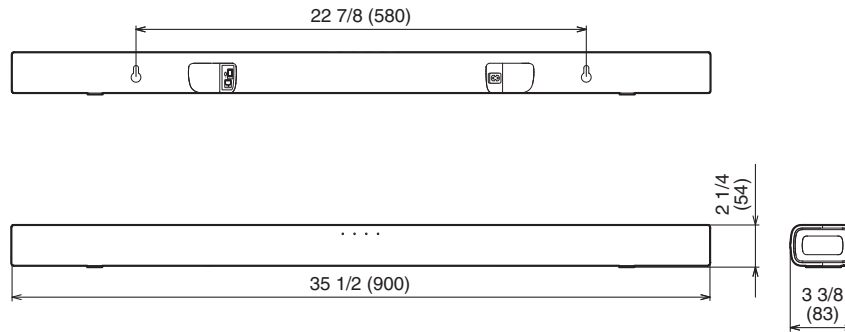

## ■ Weight : 3 lbs 16 oz (1.8 kg)



## Subwoofer

### ■ General

Operating temperature:	41 °F - 95 °F (5 °C - 35 °C)
Power supply:	AC 120 V, 60 Hz
Power consumption:	40 W
Power consumption in standby mode:	0.26 W
Power consumption in Bluetooth standby:	1.1 W



## ■ Dimensions (Unit : in. (mm))

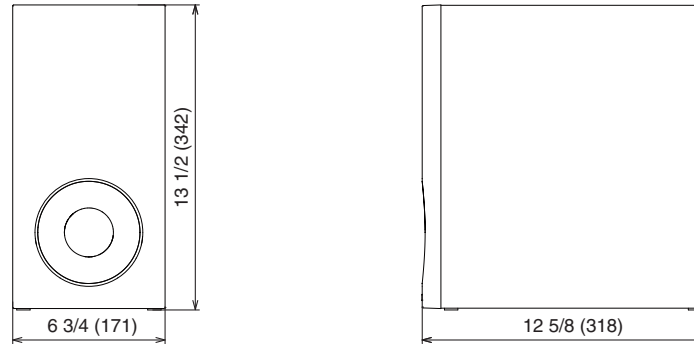

## ■ Weight: 11 lbs 7 oz (5.2 kg)



DENON®

[www.denon.com](http://www.denon.com)

3520 10646 00ADA

Copyright © 2018 D&M Holdings Inc. All Rights Reserved.

