

Operating and installation instructions Fridge-freezer



To avoid the risk of accidents or damage to the appliance it is **essential** to read these instructions before it is installed and used for the first time.

Contents

Warning and Safety instructions	5
Caring for the environment	14
Saving energy	15
Guide to the appliance	17
Accessories	19
Accessories supplied	19
Optional accessories	19
Switching on and off	21
Before using for the first time	21
Cleaning the appliance	21
Switching off for longer periods of time	22
The correct temperature	23
... in the refrigerator section	23
... in the freezer section	23
Temperature display	24
Setting the temperature in the refrigerator/freezer sections	24
Using Super freeze and Dynamic cooling	26
Super freeze function	26
DynaCool function	27
Temperature and door alarm	28
Freezer section with temperature alarm	28
Door alarm	28
Switching the alarm off early	28
Selecting further settings	29
Settings mode	29
Storing food in the refrigerator section	31
Different storage zones	31
Food which is not suitable for storage in the refrigerator section	32
Notes on buying food	32
Storing food correctly	32
Adjusting the interior fittings (refrigerator section)	33
Adjusting the door/bottle shelf	33
Moving the shelves	33
Adjusting or removing the bottle holder	33
Adjusting the bottle rack	34

Moving the charcoal filters	34
Freezing and storing food	35
Maximum freezing capacity	35
Freezing fresh food.....	35
Storing frozen food.....	35
Home freezing	36
Placing food in the freezer.....	37
Storage time for frozen food.....	37
Defrosting frozen goods	38
Cooling drinks quickly	38
Using accessories	38
Adjusting the interior fittings.....	39
Defrosting	40
Cleaning and care	41
Cleaning agents.....	41
Preparing the refrigeration appliance for cleaning	42
Cleaning the interior and accessories	43
Cleaning the front of the appliance and the side panels.....	44
Stainless steel appliances	44
Cleaning the ventilation gaps.....	44
Cleaning the compressor and metal grille at the back of the appliance.....	45
Cleaning the door seal	45
After cleaning	46
Replacing the charcoal filters.....	46
Problem solving guide	48
Noises	54
Service	55
Contact in the event of a fault	55
EPREL database	55
Warranty	55

Contents

Installation	56
Installation	56
Side-by-side installation.....	56
Location.....	56
Ventilation.....	58
Fitting wall spacers supplied.....	58
Installing the refrigeration appliance	59
Levelling the appliance door	59
Installing the refrigeration appliance in a run of kitchen units	60
Appliance dimensions	62
Changing the door hinging.....	63
Electrical connection	66

Warning and Safety instructions

This refrigeration appliance complies with current safety requirements. Inappropriate use can, however, lead to personal injury and material damage.

Please read the operating and installation instructions carefully before using the refrigeration appliance for the first time. They contain important information on safety, installation, use and maintenance. This is to protect yourself from injury, and from damaging your refrigeration appliance.

In accordance with standard IEC 60335-1, Miele expressly and strongly advises that you read and follow all information provided on installing the refrigeration appliance, as well as the safety notes and warnings.

Miele cannot be held liable for injury or damage caused by non-compliance with these instructions.

Keep these operating and installation instructions in a safe place and pass them on to any future owner.

Correct application

- ▶ This refrigeration appliance is intended for use in the home and in similar environments, for example
 - in shops, offices and similar work settings
 - by the guests in hotels, motels, bed & breakfasts and other typical home settings.

This refrigeration appliance is not intended for outdoor use.

- ▶ This appliance is intended for domestic use only for cooling and storing food and drink as well as for storing deep frozen food, freezing fresh food and for making ice. Any other usage is not supported by the manufacturer and could be dangerous.

Warning and Safety instructions

▶ This refrigeration appliance is not suitable for storing and keeping cool medicines, blood plasma, laboratory preparations or similar substances or products that are subject to the Medical Device Directive. Incorrect use of the refrigeration appliance for such purposes may cause deterioration of the items stored. The refrigeration appliance is also not suitable for use in areas where there is a risk of explosion.

Miele cannot be held liable for damage caused by improper or incorrect use or operation of the appliance.

▶ The appliance can only be used by people with reduced physical, sensory or mental capabilities, or lack of experience and knowledge, if they are supervised whilst using it, or have been shown how to use it in a safe way and recognise and understand the consequences of incorrect operation.

Safety with children

▶ Children under 8 years of age must be kept away from the refrigeration appliance unless they are constantly supervised.

▶ Children 8 years and older may only use the appliance unsupervised if they have been shown how to use it in a safe way and recognise and understand the consequences of incorrect operation.

▶ Children must not be allowed to clean or maintain the appliance unsupervised.

▶ Please supervise children in the vicinity of the appliance and do not let them play with it.

▶ Danger of suffocation! Whilst playing, children could become entangled in packaging (such as plastic wrapping) or pull it over their head and suffocate. Keep packaging material away from children.

Technical safety

▶ The coolant circuit has been checked for leaks. The refrigeration appliance complies with statutory safety requirements and the appropriate EU directives.



▶ This refrigeration appliance contains the refrigerant isobutane (R600a), a natural gas which is environmentally friendly but flammable. The refrigerant does not damage the ozone layer and does not contribute to the greenhouse effect.

The use of this refrigerant has, however, led to a slight increase in the noise level of the appliance. In addition to the noise of the compressor, you might be able to hear the refrigerant flowing around the cooling circuit. Unfortunately, this cannot be avoided, but it does not affect the performance of the refrigeration appliance.

When transporting and installing the refrigeration appliance, ensure that no parts of the cooling circuit are damaged. Splashes of refrigerant can damage the eyes.

In the event of damage:

- Avoid naked flames or anything which creates a spark.
- Disconnect the refrigeration appliance from the mains electricity supply.
- Ventilate the room where the refrigeration appliance is located for several minutes.
- Contact the Miele Customer Service Department.

▶ The more coolant there is in a refrigeration appliance, the larger the room it should be installed in. In the event of a leakage, if the appliance is in a small room, there is the danger of a combustible gas/air mixture building up. For every 11 g of coolant at least 1 m³ of room space is required. The amount of coolant in the refrigeration appliance is stated on the data plate inside the appliance.

Warning and Safety instructions

- ▶ To avoid the risk of damage to the appliance, make sure that the connection data (fuse rating, frequency and voltage) on the data plate corresponds to the household supply. Check that this is the case before connecting the appliance. Consult a qualified electrician if in any doubt.
- ▶ The electrical safety of this appliance can only be guaranteed when correctly earthed. It is essential that this standard safety requirement is met. If in any doubt please have the electrical installation tested by a qualified electrician.
- ▶ Reliable and safe operation of this appliance can only be assured if it has been connected to the mains electricity supply.
- ▶ If the electrical connection cable is faulty it must only be replaced by a Miele authorised service technician to protect the user from danger.
- ▶ Do not connect the appliance to the mains electrical supply by a multi-socket adapter or extension lead. These are a fire hazard and do not guarantee the required safety of the appliance.
- ▶ If moisture gets into electrical components or into the mains connection cable, it could cause a short circuit. Therefore, do not operate this refrigeration appliance in areas which are exposed to moisture (e.g in a garage or utility room).
- ▶ This appliance must not be used in a non-stationary location (e.g. on a ship).
- ▶ Do not use a damaged appliance. It could be dangerous. Check the appliance for visible signs of damage.
- ▶ This refrigeration appliance is not intended for use as a built-in appliance.
- ▶ The appliance must be isolated from the electricity supply during installation, maintenance and repair work.

Warning and Safety instructions

- ▶ Unauthorised installation, maintenance and repairs can cause considerable danger for the user. Installation, maintenance and repairs must only be carried out by a Miele authorised technician.
- ▶ While the appliance is under warranty, repairs should only be undertaken by a Miele authorised service technician. Otherwise the warranty is invalidated.
- ▶ Faulty components must only be replaced with genuine Miele original spare parts. Miele can only guarantee the safety standards of the appliance when Miele replacement parts are used.
- ▶ This refrigeration appliance is supplied with a special lamp to cope with particular conditions (e.g. temperature, moisture, chemical resistance, abrasion resistance and vibration). This lamp must only be used for the purpose for which it is intended. The lamp is not suitable for room lighting. Replacement lamps may only be fitted by a Miele authorised technician or by the Miele Customer Service Department. This refrigeration appliance contains several light sources with at least energy efficiency class G.

Correct use

- ▶ This refrigeration appliance is designed for use within specific ambient temperatures (climate range). Do not use in ambient temperatures for which it is not designed. The climate range is stated on the data plate in the interior cabinet of the refrigeration appliance. A lower ambient temperature will cause the compressor to switch off for longer periods, meaning that the refrigeration appliance is unable to maintain the required temperature.
- ▶ Do not cover or block the air vents as this could impair the efficiency of the appliance, increase the electricity consumption and could cause damage to the components.
- ▶ If storing food which contains a lot of fat or oil in the appliance or the door, make sure that it does not come into contact with plastic components as this could cause stress cracks or break the plastic.

Warning and Safety instructions

- ▶ Risk of fire and explosion. Do not store explosive materials in the refrigeration appliance or any products containing propellants (e.g. spray cans). Electrical components can cause flammable mixes of gases to ignite.
- ▶ Danger of explosion. Do not operate any electrical equipment (e.g. an electric ice-cream maker) inside the refrigeration appliance.
Danger of sparking and explosion.
- ▶ Danger of injury and damage to the appliance. Do not store cans or bottles containing carbonated drinks or liquids which could freeze in the freezer zone. Otherwise they could burst.
- ▶ Danger of injury and damage to the appliance. When cooling drinks quickly in the freezer zone, make sure bottles are not left in for more than one hour. Otherwise they could burst.
- ▶ Danger of injury. Never handle frozen food or the metal parts of the appliance with wet hands. Your hands may freeze to the frozen food or to the metal.
- ▶ Danger of injury. Do not take ice cubes out with your bare hands and never place ice cubes or ice lollies in your mouth straight from the freezer zone. The very low temperature of the frozen food can cause frost burn to the lips and tongue.
- ▶ Do not refreeze partially or fully defrosted food. Consume defrosted food as soon as possible, as it will lose its nutritional value and spoil if left for too long. Defrosted food may only be re-frozen after it has been cooked.
- ▶ Observe the manufacturer's "use-by" dates and storage instructions given on food to avoid the risk of food poisoning. Storage times will depend on several factors, including the freshness and quality of the food, as well as the temperature at which it is stored.

Accessories and spare parts

- ▶ Only use genuine original Miele accessories and spare parts with this appliance. Using accessories or spare parts from other manufacturers will invalidate the warranty, and Miele cannot accept liability.
- ▶ Miele will guarantee to supply functional spare parts for a minimum of 10 years and up to 15 years following the discontinuation of your refrigeration appliance.

Warning and Safety instructions

Cleaning and care

- ▶ Do not use any oils or grease on the door seals, as these will cause the seals to deteriorate and become porous with time.
- ▶ Do not use a steam cleaning appliance to clean or defrost this appliance.
Steam could reach electrical components and cause a short circuit.
- ▶ Sharp edged or pointed objects will damage the evaporator, causing irreversible damage to the appliance. Do not use sharp edged or pointed objects to
 - remove frost and ice,
 - separate frozen food or remove ice trays.
- ▶ Do not place electric heaters or candles in the appliance to defrost it. These can damage the plastic parts.
- ▶ Do not use defrosting sprays or de-icers, as they could contain substances which could damage the plastic parts or which might cause the build-up of gases and pose a danger to health.

Transport

- ▶ Always transport the appliance in an upright position and in its original transport packaging to avoid damage in transit.
- ▶ Danger of injury and damage to the appliance. The refrigeration appliance is very heavy and must be transported by two people.

Disposal of your old appliance

- ▶ If your old refrigeration appliance has a door lock, destroy it. This will prevent the risk of children playing accidentally locking themselves in and endangering their lives.
- ▶ Splashes of coolant can damage the eyes. Be careful not to damage any part of the pipework whilst awaiting disposal, e.g. by
 - puncturing the coolant channels in the condenser,
 - bending any pipework, or
 - scratching the surface coating.

Symbol on the compressor (depending on model)

This information is only relevant for recycling. There is no risk during normal operation.



- ▶ The oil in the compressor can be fatal if swallowed or if it penetrates the airways.

Caring for the environment

Disposal of the packing material

The packaging is designed to protect the appliance from damage during transportation. The packaging materials used are selected from materials which are environmentally friendly for disposal and should be recycled.

Recycling the packaging reduces the use of raw materials in the manufacturing process and also reduces the amount of waste in landfill sites.

Disposing of your old appliance

Electronic and electrical appliances contain many valuable materials. They also contain certain materials, compounds and components which were essential for their correct functioning and safety. These could be hazardous to your health and to the environment if disposed of with general waste or if handled incorrectly. Please do not, therefore, dispose of your old appliance with general waste.

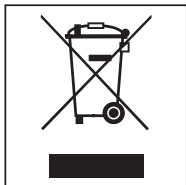

Instead, please make use of officially designated collection and disposal points to dispose of and recycle electrical and electronic appliances in your local community, with your dealer or with Miele. By law, you are solely

responsible for deleting any personal data from the appliance prior to disposal.

Take care not to damage your refrigeration appliance's pipework before or during transportation to an authorised collection depot.

This is to ensure that coolant in the cooling circuit and oil in the compressor is contained, and will not leak into the environment.

Please ensure that your old appliance poses no risk to children while being stored prior to disposal. For further information, see "Warning and Safety instructions" in these operating and installation instructions.

Saving energy

	Normal energy consumption	Increased energy consumption
Installation / Maintenance	In a ventilated room.	In an enclosed, unventilated room.
	Protected from direct sunlight.	In direct sunlight.
	Not near to a heat source (radiator, oven).	Near to a heat source (radiator, oven).
	Where the ideal ambient room temperature is approx. 20 °C.	Where the ambient room temperature is above 25 °C.
	Ventilation gaps uncovered and dusted regularly.	Ventilation gaps covered or dusty.
	Compressor and metal grille (heat exchanger) at the back of the appliance dusted at least once a year.	Dust build-up on the compressor and metal grille (heat exchanger).
Temperature setting	Refrigerator section 4 to 5 °C	The lower the temperature, the higher the energy consumption.
	Freezer section -18 °C	

Saving energy

	Normal energy consumption	Increased energy consumption
Use	Drawers and shelves arranged as they were when the appliance was delivered.	
	Only open the door when necessary and for as short a time as possible. Store food in an organised way.	Frequent opening of doors for long periods will cause a loss of coldness. The appliance will try to cool down and the compressor will run for longer periods.
	Take an insulated cool bag when shopping, and load food in the appliance as soon as possible. Replace any food removed as quickly as possible, before it warms up too much. Allow hot food and drinks to cool down before placing them in the appliance.	Hot food or food at room temperature raises the temperature inside the appliance. The appliance will try to cool down and the compressor will run for longer periods.
	Store food well packaged or covered.	The evaporation or condensation of liquids in the refrigerator section will cause a loss of coldness.
	Place frozen food in the refrigerator to defrost.	
	Do not over-fill the appliance to allow air to circulate.	Poor air circulation will cause a loss of coldness.

Fascia panel

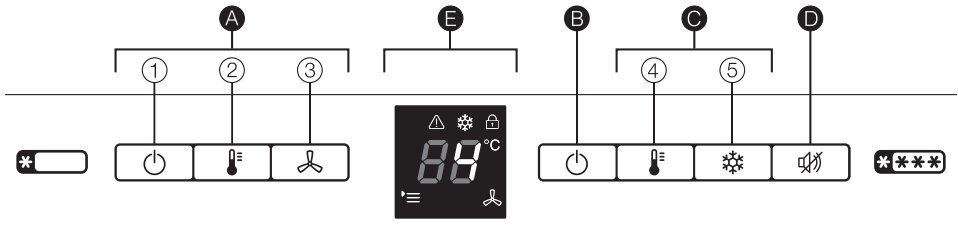

A Controls, refrigerator section

- ① On/Off button for refrigerator section
- ② Temperature setting button
- ③ DynaCool button (automatic temperature distribution)

B Main On/Off button for entire refrigeration appliance

C Controls, freezer section

- ④ Temperature setting button
- ⑤ SuperFreeze button

D Alarm off button

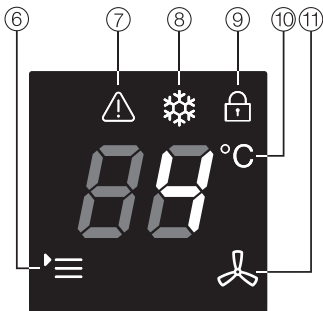

E Display

- ⑥ Menu symbol (Settings mode for: switching the safety lock on/off, switching Sabbath mode on/off)
- ⑦ Alarm symbol
- ⑧ SuperFreeze symbol
- ⑨ Lock symbol
- ⑩ Temperature display
- ⑪ DynaCool symbol

Guide to the appliance

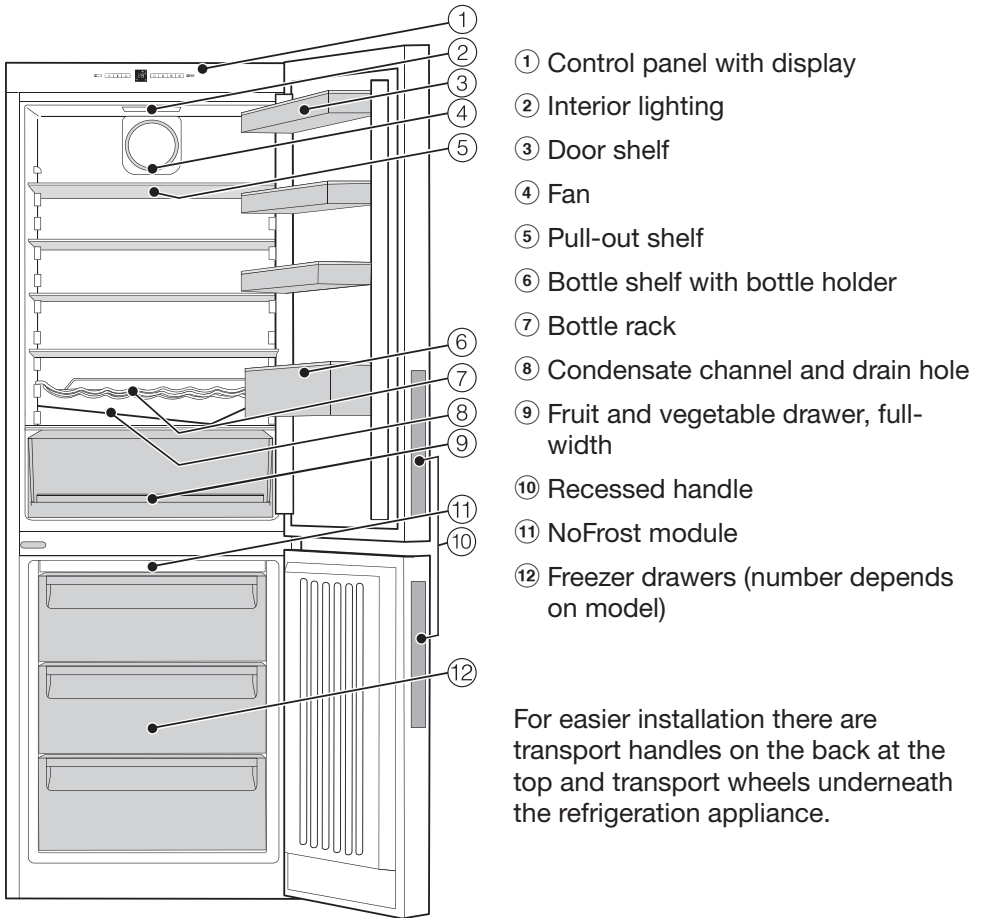

For easier installation there are transport handles on the back at the top and transport wheels underneath the refrigeration appliance.

This drawing is for illustration purposes only.

Accessories supplied

Bottle rack

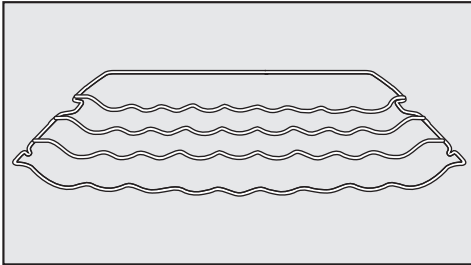

Bottles can be stored horizontally using the bottle rack to save space. The bottle rack can be placed at different positions in the appliance.

Bottle holder

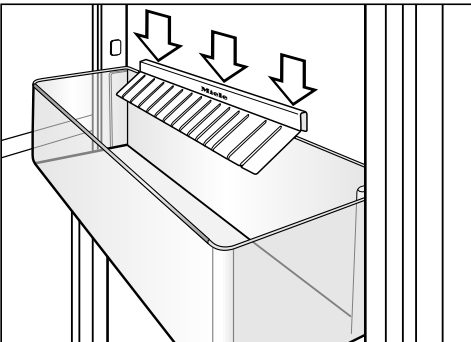

The flexible ribs grip the bottles securely when the door is opened and closed.

Egg tray

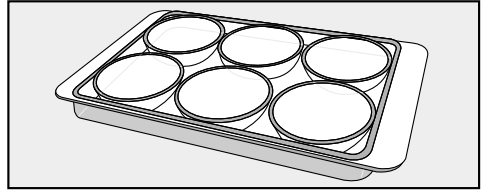

Ice cube tray

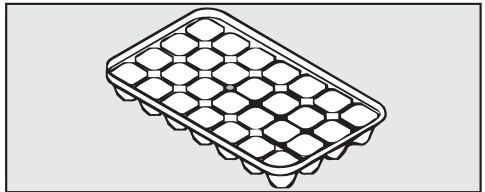

Optional accessories

A range of useful Miele accessories and care products are available for your appliance.

Accessories are available to order via the Miele Webshop, from Miele directly (see back cover for contact details) or from your Miele dealer.

Multi-purpose microfibre cloth

The microfibre cloth is suitable for removing fingerprints and light soiling from surfaces such as stainless steel, glass, plastic and chrome without the use of chemicals.

Accessories

MicroCloth Kit

The MicroCloth Kit contains a universal cloth, a glass cloth and a polishing cloth.

These cloths are extremely resistant to tearing and very robust. Thanks to very fine microfibres these cloths achieve an excellent cleaning performance.

KKF-FF charcoal filter with holder (Active AirClean)

Charcoal filters neutralise unpleasant odours in the fridge zone for improved air quality.

KKF-RF replacement filters (Active AirClean)

Replacement filters to fit the holder are available. We recommend replacing the charcoal filters every 6 months.

Before using for the first time

Packaging material

- Remove all packaging material from the inside of the appliance.

Protective foil

The appliance is covered with a special foil to protect it during transportation.

- Do not remove the foil until the appliance has been positioned in its final location.

Cleaning the appliance

Please refer to the relevant instructions in "Cleaning and care".

- Clean the inside of the appliance and the accessories.

Switching the refrigeration appliance on

To enable the temperature to get sufficiently cold inside the appliance, allow the freezer section to run for about 2 hours before placing food in the appliance.

Do not place food in the freezer section until it has reached the required coldness (at least $-18\text{ }^{\circ}\text{C}$).

The freezer section and the refrigerator section can be switched on at the same time using the right-hand main On/Off button .

The compressor can take up to 8 minutes to switch on due to a built-in switch delay. This delay is designed to increase the lifespan of the compressor.

- Press the right-hand main On/Off button  to switch on the freezer section and the refrigerator section.

The refrigeration appliance will start to cool and the temperature required will appear in the freezer section temperature display. The interior lighting of the refrigerator section will come on when the door is opened.

Switching on and off

Switching off the refrigeration appliance

The whole refrigeration appliance can be switched off if the temperature in the freezer section is visible in the display.

- To switch off the freezer section and the refrigerator section, press and hold the right-hand main On/Off button  until the display goes out.

The refrigerator section and freezer section are switched off. If this does not work, the safety lock is activated (see “Selecting further settings – Activating and deactivating the safety lock”).

The interior lighting of the refrigerator section will go out and the cooling process will be switched off.

Switching off the refrigerator section separately

The refrigerator section can be switched off without having to switch off the freezer section. This is useful, e.g. whilst on holiday.

If the temperature for the refrigerator is visible in the display, you can switch the refrigerator section off.

- To switch off the refrigerator section, press the left-hand On/Off button  until the display goes out.

The interior lighting and the temperature display for the refrigerator section will go out. The refrigerator section is switched off. The temperature in the freezer section is visible in the display

Switching the refrigerator section back on again

The refrigerator section can also be switched back on again separately.

- To switch the refrigerator section on, press the left-hand On/Off button  twice.

The temperature indicator for the refrigerator section lights up. The refrigerator section will start to cool and the interior lighting will come on when the appliance door is opened.

Switching off for longer periods of time

If, during a long absence, the refrigeration appliance is switched off but not cleaned and the door(s) left shut, there is a risk of mould forming inside the appliance. It is essential to clean the refrigeration appliance.

If the refrigeration appliance is not going to be used for a longer period of time, observe the following:

- Switch the refrigeration appliance off.
- Switch the appliance off at the wall socket and pull the plug out of the socket, or disconnect the fuse.
- Clean the refrigeration appliance and leave the door ajar to air the appliance and avoid odours building up inside.

The correct temperature

It is very important to set the correct temperature for storing food in the appliance. Bacteria will cause food which is not stored at the correct temperature to deteriorate rapidly. Temperature influences the growth rate of these bacteria. Reducing the temperature reduces their growth rate.

The temperature in the refrigeration appliance will rise:

- The more often the appliance door is opened and the longer it is kept open
- The more food that is stored in it
- The warmer the food is which is being put into it
- The higher the ambient temperature surrounding the refrigeration appliance. This refrigeration appliance is designed for use within specific ambient temperatures (climate range). Do not use in ambient temperatures for which it is not designed.

... in the refrigerator section

We recommend a temperature of **4 °C** in the refrigerator section.

... in the freezer section

To freeze fresh food and to store frozen food for long periods, a temperature of **-18 °C** is required. At this temperature the growth of bacteria is generally halted. As soon as the temperature rises above -10 °C, the bacteria become active in the food again so it cannot be kept as long. For this reason, partially defrosted or defrosted food must not be re-frozen. Food may be re-frozen once it has been cooked, as the high temperatures achieved when cooking destroy most bacteria.

The correct temperature

Temperature display

In normal operation the temperature display either shows the **required temperature in the refrigerator section** or the **required temperature in the freezer section**.

Tip: To switch between temperature displays, press the relevant button  of the section you wish to view.

The **displayed temperature will flash** if a different temperature is set.

The **required temperature in the freezer section temperature display and the alarm symbol  will flash:**

- If the temperature is not within the normal temperature display range.
- The temperature in the appliance has risen by several degrees, indicating that the appliance is warming up too much. At the same time an alarm will sound.

This short-term loss of coldness is no cause for concern in the following circumstances:

- If the appliance doors were left open for longer than usual, e.g. when a large amount of food is being loaded or taken out.
- If you have just placed fresh food in the appliance for freezing.

Setting the temperature in the refrigerator/freezer sections

The temperature can be adjusted:

- In the refrigerator section from 3 °C to 9 °C
- In the freezer section from -16 °C to -26 °C

The temperatures for the refrigerator section and the freezer section can be adjusted using the relevant button .

- Press the  button repeatedly until the temperature you want is shown in the temperature display.

The first time you press the button the last temperature set will flash in the display.

The temperature value will change until the highest setting is reached. It will then drop back to the lowest setting.

After a short while the newly selected temperature is set and will appear in the temperature display.

The refrigerator section temperature set will now light up. The temperature set for the freezer section will now flash until the temperature has been reached.

The temperature in the appliance will now adjust slowly to the newly set temperature.

Tip: If you have adjusted the temperature, **wait for approx. 6 hours if the appliance is not very full and for approx. 24 hours if the appliance is full** before checking the temperature display. It will take this long for the appliance to give an accurate reading.

- If, after this time, the temperature is still too high or too low, you will need to adjust it again.

Using Super freeze and Dynamic cooling

Super freeze function

Switch on Super freeze before putting fresh food into the freezer.

This helps food to freeze quickly and retain its nutrients, vitamins, flavours and appearance.

Exceptions:

- when placing food in the freezer that is already frozen.
- when freezing up to 2 kg fresh food daily.

The Super freeze function can be switched on if the temperature in the freezer section is visible in the temperature display.

Switching on SuperFreeze

The SuperFreeze function should be switched on **6 hours before placing food in the freezer section**. When freezing the **maximum amount of food** the SuperFreeze function should be switched on **24 hours beforehand**.

The compressor can take up to 8 minutes to switch on due to a built-in switch delay. This delay is designed to increase the lifespan of the compressor.

- Briefly press the ❄️ button.

The ❄️ symbol lights up. The refrigeration appliance will work at full power to lower the temperature in the freezer section.

Switching off SuperFreeze

The SuperFreeze function will switch itself off automatically after approx. 65 hours. The ❄️ symbol will go out and the refrigeration appliance will run at normal power again.

To save energy, you can switch the SuperFreeze function off yourself before this time.

- Press the ❄️ button so that the ❄️ symbol goes out.

The refrigeration appliance will then continue running at normal power.

Using Super freeze and Dynamic cooling

DynaCool function

When the dynamic cooling (DynaCool) function is not switched on, the natural circulation of air in the appliance will cause different temperature zones in the refrigerator section, as the cold, heavy air will sink to the lowest section of the appliance. You should bear this in mind when placing food in the appliance (see “Storing food in the refrigerator section”).

However, if you are placing a large amount of food in the refrigerator (e.g. for a party), it is a good idea to switch on DynaCool. This will distribute the temperature in the appliance to all areas more evenly so that all the food is chilled to about the same degree. The temperature is set as normal with the temperature control.

DynaCool should also be selected for the following conditions:

- The ambient temperature in the room is high (above approx. 30 °C).
- The humidity levels are high (e.g. in the summer).

The DynaCool function can be switched on if the temperature in the refrigerator section is visible in the temperature display.

Switching on DynaCool



- Briefly press the  button.

The  symbol lights up.

The fan is now ready for operation and will switch on automatically when the compressor is running.

Switching off DynaCool

As the energy consumption increases when DynaCool is switched on, you should turn it off under normal conditions.

- Press the  button so that the  symbol goes out.

To save energy, the fan switches off automatically whilst the door is open.

Temperature and door alarm

The appliance has a warning system which ensures that the temperature in the freezer cannot rise unnoticed and to avoid energy being wasted if a door is left open.

Freezer section with temperature alarm

If the temperature in the freezer becomes too warm, the temperature display and the  symbol will flash. An alarm tone will also sound.

The temperature the appliance is set at determines the temperature the appliance recognises as being too warm.

The audible and visual signals will be activated if:

- You switch on the refrigeration appliance and the temperature in a temperature zone differs greatly from the set temperature.
- A lot of warm room air enters the freezer when you are rearranging or taking out frozen goods.
- You are freezing large amounts of food at once.
- You are freezing warm food.
- There was a mains outage.
- The refrigeration appliance has a fault.

The alarm will stop and the  symbol will go out when the temperature reaches the correct level again. The temperature display will light up again constantly.

 Health risk caused by decomposing food.

If the temperature in the freezer section remains above $-18\text{ }^{\circ}\text{C}$ for a long time, the frozen goods can start to defrost. This will reduce the storage life of the food.

Check whether the frozen goods have started to defrost. If they have, check that the food is safe to use and if it is, then use it as soon as possible or cook it before freezing it again.

Door alarm

An alarm will sound if the appliance door has been left open for longer than 60 seconds.

As soon as the door is closed, the alarm sound will stop.

Switching the alarm off early

If the alarm disturbs you, it can be turned off early.

- Press the  button.

The alarm will stop.

If the alarm is due to the temperature rising, the  symbol will stay on until the set temperature has been reached.

Settings mode

Certain settings on the refrigeration appliance can only be selected in settings mode.

Activating or deactivating the lock	c
Setting Sabbath mode	5

Settings mode is represented in the display by the '≡ symbol.

The procedure for accessing settings mode and for changing settings is described below.

Activating or deactivating the lock



The safety lock function can be activated to prevent the refrigeration appliance being switched off by mistake.

– To activate the lock

- Press the  button for approx. 5 seconds.

The '≡ symbol lights up and 5 flashes in the display.

Settings mode is now activated.

- Press the freezer section button ; c flashes in the display.
- Press the  button briefly to access the safety lock function.

c1 will appear in the display.

- Press the  button briefly to activate the lock.

The  symbol lights up.

- Press the right-hand main On/Off button  for the freezer section to exit Settings mode.



The temperature will appear in the display.

– To deactivate the lock

- Press the  button for approx. 5 seconds.

The  symbol and the '≡ symbol will light up and 5 will start flashing in the display.

Settings mode is now activated.

- Press the freezer section button ; c flashes in the display.
- Press the  button briefly to access the safety lock function.

c1 will appear in the display.

- Press the  button briefly to deactivate the lock.

The  symbol will go out.

- Press the main On/Off button  for the freezer section to exit Settings mode.

The temperature will appear in the display.

Selecting further settings

Switching Sabbath mode on/off



Health risk caused by decomposing food.

As any mains outage during Sabbath mode is not indicated, the frozen goods may thaw or defrost. This will reduce the storage life of the food.

Check whether the frozen goods have started to defrost. If they have, check that the food is safe to use and if it is, then use it as soon as possible or cook it before freezing it again.

The refrigeration appliance has a Sabbath mode to support the observance of religious customs.

The following functions are deactivated with Sabbath mode:

- interior lighting when the door is opened
- all acoustic and visual signals
- temperature display
- The SuperFreeze and DynaCool functions (if previously selected)

The ❄️ button for turning off Sabbath mode can be selected.

The Sabbath mode function will switch itself off automatically after approx. 120 hours.

Ensure that the doors are properly closed, as visual and audible alarms are switched off.

- Switching Sabbath mode on

- Press the ❄️ button for approx. 5 seconds.

The '≡ symbol lights up and 5 flashes in the display.

Settings mode is now activated.

- Press the ❄️ button briefly to access the Sabbath mode function.

57 will appear in the display.

- Press the ❄️ button briefly to confirm the setting.

The display will go out and Sabbath mode is switched on.

- Switching Sabbath mode off

- Press the ❄️ button twice briefly to switch the Sabbath mode function off.

The '≡ symbol lights up and 5 flashes in the display.

Settings mode is now activated.

Sabbath mode is switched off.

- Press the main On/Off button ⏻ to exit Settings mode.

Storing food in the refrigerator section



Risk of explosion due to flammable mixes of gases.

Electrical components can cause flammable mixes of gases to ignite.

Do not store explosive materials in the refrigeration appliance or any products containing propellants (e.g. spray cans).



Risk of damage due to greasy or oily food.

If storing food which contains a lot of fat or oil in the refrigeration appliance or the appliance door, make sure that it does not come into contact with plastic components as this could cause stress cracks or break the plastic.

Make sure that no fat or oil leaks onto the plastic parts of the refrigeration appliance.

Tip: Do not store food in such a way that it touches the rear wall of the refrigerator section as it may freeze to the rear wall.

This appliance has Dynamic cooling, which helps to keep an even temperature when the fan is running, making the difference between the various zones less pronounced.

Warmest area

The warmest area in the refrigerator section is at the top in the front area and in the door. Use this for storing butter and cheese.

Coldest area

The coldest area in the refrigerator section is directly above the fruit and vegetable drawer and at the back of the appliance.

Use these areas to store all delicate and highly perishable food such as:

- Fish, meat, poultry
- Cold cuts, ready meals
- Dishes or baked goods containing eggs or cream
- Fresh dough, cake mixtures, pizza or quiche dough
- Raw milk cheese and other raw milk products
- Pre-packed vegetables
- Other fresh food (with a label stating it should be kept at a temperature of approx. 4 °C)

Different storage zones

Due to natural air circulation, there are different temperature zones in the refrigerator section.

Cold, heavy air sinks to the lowest section of the refrigeration section.

Make use of the different zones when placing food in the appliance.

Tip: To allow air to circulate efficiently, do not pack food too closely together in the appliance.

If there is insufficient air circulation, the cooling performance will decrease and energy consumption will increase.

Do not cover the fan in the rear wall of the appliance.

Storing food in the refrigerator section

Food which is not suitable for storage in the refrigerator section

Not all food is suitable for refrigeration at temperatures below 5 °C, because it may be sensitive to cold. Depending on the type of food, the appearance, consistency, flavour and/or vitamin content may be altered if stored at too cold a temperature.

Food which is sensitive to cold includes:

- Pineapples, avocados, bananas, pomegranates, mangoes, melons, papayas, passionfruit, citrus fruit such as lemons, oranges, mandarins, grapefruit
- Fruit (which is not yet ripe)
- Aubergines, cucumbers, potatoes, peppers, tomatoes, courgettes
- Hard cheeses (e.g. Parmesan, mountain cheese)

Notes on buying food

The freshness of the food when it is first placed in the appliance is the most important factor for how long it stays fresh.

Take into account the use-by date and the correct storage temperature.

Time out of the refrigerator, e.g. transporting food in a warm car, should be kept to a minimum.

Storing food correctly

Ensure that food stored in the fridge zone is **covered or wrapped properly**.

This will prevent food odours from affecting other foods, stop food from drying out and also prevent any cross-contamination of bacteria. This is particularly important when storing meat products. Make sure that food such as raw meat and fish in particular does not come into contact with other food.

By ensuring that the temperature settings are correct and by taking appropriate hygiene measures you can prolong the storage life of your food considerably and avoid food waste.

Fruit and vegetables

Fruit and vegetables can be stored loose in the fruit and vegetable drawer.

Protein-rich food

Please note that food rich in protein deteriorates faster than other types of food. Shellfish, for example, deteriorates faster than fish, and fish deteriorates faster than meat.

Adjusting the interior fittings (refrigerator section)

Adjusting the door/bottle shelf

Only move door/bottle shelves when they are empty.

- Push the door/bottle shelf upwards, then remove it by pulling it forwards.
- Replace the shelf at the required height. Ensure that it is securely pushed back into position.

Moving the shelves

Stoppers prevent the shelves from being dislodged by mistake.

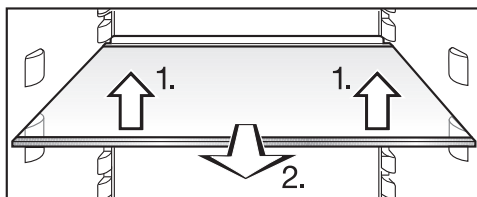

- The shelves can be adjusted according to the height of the refrigerated goods:

1. Lift it up slightly at the front.
2. Remove it from the appliance.

The raised edge on the protective strip at the back must face upwards to prevent food from touching the back of the appliance and freezing to it.

- Replace it on the level you want.

Adjusting or removing the bottle holder

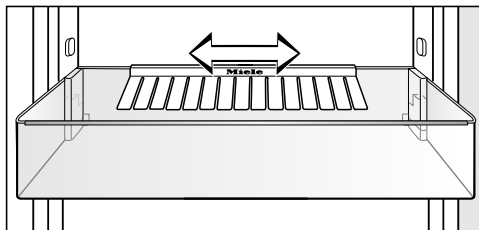

The bottle holder can be moved left or right to create more room for drink cartons.

The bottle holder can be removed completely (e.g. for cleaning):

- Pull the bottle holder upwards to remove it from the rear edge of the bottle shelf.

The bottle holder can be replaced after cleaning.

Adjusting the interior fittings (refrigerator section)

Adjusting the bottle rack

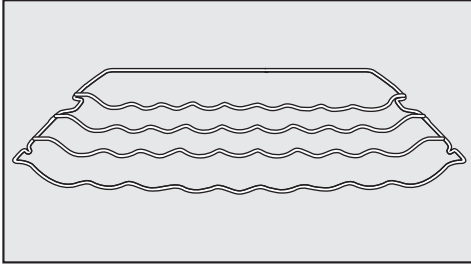

The bottle rack can be placed at different positions in the appliance.

- Raise the bottle rack slightly at the front, and pull it forwards a little until the notch at the side is in line with the shelf support. It can then be raised or lowered to the required level.

The rear rail must face upwards to prevent bottles from touching the back of the appliance.

Stoppers prevent the bottle rack from being dislodged by mistake.

Moving the charcoal filters

Charcoal filters and a KKF-FF (Active AirClean) holder are available as optional accessories (see “Accessories - optional accessories”).

When storing very strong smelling food (e.g. very ripe cheese):

- Place the holder with the charcoal filters on the shelf where this food is kept.
- Change the filters sooner if necessary.
- Use more charcoal filters (with holders) in the appliance (see “Accessories – Optional accessories”).

The holder for the charcoal filters sits on the protective strip at the back of the shelf.

- To move the charcoal filters, pull the holder upwards to remove it from the protective strip.

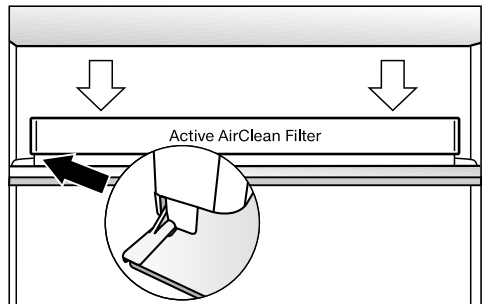

- Refit the holder on the protective strip of the shelf you wish to use it on.

Maximum freezing capacity

To ensure that fresh food placed in the freezer freezes through to the core as quickly as possible, the maximum freezing capacity must not be exceeded. The maximum freezing capacity for freezing within a 24-hour period is given on the data plate: "Freezing capacity ... kg/24 hrs".

Freezing fresh food

Fresh food should be frozen as quickly as possible. This way the nutritional value of the food, its vitamin content, appearance and taste are not impaired.

Food which takes a long time to freeze will lose more water from its cells, which then shrink. During the defrosting process, only some of this water is reabsorbed by the cells. What this means in practice is that the food loses more moisture. You can see this in the large amount of water that collects around the food when it defrosts.

If food is frozen quickly, the cells have less time to lose moisture, so they shrink less. As there is not so much moisture loss, it is easier for the food to reabsorb it during the defrosting process, and very little water collects around the defrosted food.

Storing frozen food

Never re-freeze partially or fully defrosted food. Defrosted food may only be re-frozen after it has been cooked.

When buying frozen food to store in your freezer, check:

- That the packaging is not damaged
- The use-by date
- The temperature at which the frozen food is being stored in the shop.

The length of time food can be kept is reduced if it has been stored at a temperature warmer than $-18\text{ }^{\circ}\text{C}$.

- Buy frozen food once you have finished the rest of your shopping and wrap it in newspaper or use a cool bag or cool box to transport it.
- Put it into the freezer as soon as possible.

Freezing and storing food

Home freezing

Only freeze fresh food which is in a good condition.

Hints on home freezing

- The following types of food **are suitable** for freezing:
Fresh meat, poultry, game, fish, vegetables, herbs, fresh fruit, dairy products, cakes, leftovers, egg yolks, egg whites and a range of pre-cooked meals.
- The following types of food **are not suitable** for freezing:
Grapes, lettuce, radishes, soured cream, mayonnaise, eggs in their shells, onions, whole raw apples and pears.
- To retain colour, taste, aroma and vitamin C, vegetables should be blanched before they are frozen. To do so place them portion by portion into boiling water for 2–3 minutes. Remove, and plunge into ice-cold water to cool quickly. Drain and pack ready for freezing.
- Lean meat freezes better than fatty meat, and can be stored for considerably longer.
- Separate chops, steaks, cutlets etc. with a sheet of plastic freezer film. This prevents them from freezing together in a block.
- Do not salt or season raw food or blanched vegetables before freezing. Cooked food should only be lightly salted and seasoned. Some herbs intensify the taste of food when frozen.

- Placing hot foods or drinks in the freezer causes food that is already frozen to partially thaw and increases energy consumption. Allow hot foods and drinks to cool down before placing them in the freezer.

Packaging food for freezing

- Freeze food in portions.
 - **Suitable packing material**
 - Plastic freezer bags
 - Tubular polythene freezer bags
 - Aluminum foil
 - Freezer containers
 - **Unsuitable packing material**
 - Wrapping paper
 - Greaseproof paper
 - Cellophane
 - Bin bags
 - Plastic carrier bags
 - Expel as much air as possible from the packaging.
 - Close the packaging tightly with
 - Rubber bands
 - Plastic clips
 - String
 - Freezer tape
- Tip:** Freezer bags may also be sealed using home heat sealing kits.
- Make a note of the contents and the date of freezing on the packaging.

Before placing food in the appliance

- When freezing more than 2 kg of fresh food, switch on the SuperFreeze function for some time before placing the food in the freezer (see “Using SuperFreeze and DynaCool – SuperFreeze function”).

This helps create a cold reserve in frozen goods which are already stored in the freezer.

Placing food in the freezer

 If the frozen goods are too heavy, this can cause damage. Loading frozen goods which are too heavy can cause damage to the freezer drawers.

Do not exceed the maximum load of 20 kg in each freezer drawer.

Unfrozen food should not touch frozen food as this will cause frozen food to begin to thaw.

- Make sure that the packaging and containers are dry to prevent them sticking together when frozen.

If the ventilation slots are blocked the cooling performance will decrease and energy consumption will increase.

When placing frozen goods in the freezer, make sure that the ventilation slots are not blocked.

- Place the frozen goods flat in the bottom of the top freezer drawers.

Storage time for frozen food

The storage life of food is very variable, even at a constant temperature of -18°C . Decomposition processes also take place in frozen food, albeit at a very reduced speed. For example, fat can become rancid from contact with oxygen in the air. This is why lean meat can be stored approx. twice as long as fatty meat.

The storage times quoted are guide values for the storage life of different food groups in the freezer zone.

Food group	Storage time (Months)
Ice cream	2 to 6
Bread, baked goods	2 to 6
Cheese	2 to 4
Fish, oily	1 to 2
Fish, lean	1 to 5
Sausage, ham	1 to 3
Game, pork	1 to 12
Poultry, beef	2 to 10
Vegetables, fruit	6 to 18
Herbs	6 to 10

For standard freezing results, follow the advice on packaging.

By keeping the freezer zone at a constant temperature of -18°C and taking appropriate hygiene measures you can maximise the storage life of your food and avoid food waste.

Freezing and storing food

Defrosting frozen goods

Never re-freeze partially or fully defrosted food. Defrosted food may only be re-frozen after it has been cooked.

Frozen goods can be defrosted in different ways:

- In a microwave oven
- In an oven using “Fan heat” or the “Defrost” setting
- At room temperature
- In the refrigerator zone (the cold given off by the frozen food helps to keep the other food cold)
- In a steam oven

Flat pieces of partially thawed meat or fish can be placed directly into a hot frying pan.

Meat and poultry (e.g. mince, chicken, fish fillets) should not come into contact with other foods while defrosting. Catch the liquid from defrosting and dispose of it carefully.

Fruit should be defrosted at room temperature in its packaging, or in a covered bowl.

Most vegetables can be cooked while still frozen. Just put straight into boiling water or hot fat. The cooking time is slightly less than that of fresh vegetables due to changes in the cell structure.

Cooling drinks quickly

When cooling drinks quickly in the freezer, make sure bottles are **not left in for more than one hour**; otherwise they could burst, causing injury and damage.

Using accessories

Making ice cubes

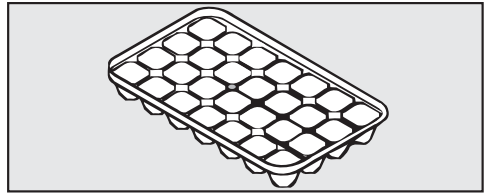

- Fill the ice cube tray three quarters full with water and place it on the bottom of one of the freezer drawers.
- Once frozen, use a blunt instrument, for example a spoon handle, to remove the ice tray from the freezer if it is stuck.

Tip: Ice cubes can be removed easily from the tray by holding it under running water for a short time.

Adjusting the interior fittings

Removing the drawers

The drawers can be removed for filling, emptying or cleaning purposes.

You can also increase the amount of space needed for freezing large frozen goods such as a turkey or large piece of game by removing a freezer drawer.

Please note that when removing the drawers, the lowest freezer drawer must always remain in the refrigeration appliance.

- Pull out the drawer as far as it will go, and then lift it up and out.

Defrosting

Refrigerator section

The refrigerator section defrosts automatically.

Condensate and frost can build up on the back wall of the refrigerator section whilst the compressor is running. You do not need to remove this, as it will defrost and evaporate automatically with the warmth generated by the compressor.

The condensate drains through a channel and drain pipe into an evaporation system at the back of the refrigeration appliance.

Keep the condensate channel and drain hole clean to enable this. Condensate must be able to drain away unhindered at all times.

Freezer section

The appliance is equipped with a “NoFrost” system. The freezer defrosts automatically.

The moisture generated in the appliance collects on the condenser and is automatically defrosted and dissipated from time to time.

This automatic defrosting system enables the freezer to remain permanently ice-free. Food stored in the freezer will not defrost with this system.

Do not let water get into the electronic module or the lighting.

 Risk of damage due to moisture ingress.

The steam from a steam cleaner can damage plastic and electrical components.

Do not use a steam cleaner to clean the refrigeration appliance.

Cleaning water must not get into the drain hole.

The data plate located inside the interior cabinet of the refrigeration appliance must not be removed. It contains information which is required in the event of a fault.

Cleaning agents

Cleaning and conditioning agents used inside the appliance must be food safe.

To avoid damaging all the surfaces of your appliance, **do not use:**

- cleaning agents containing soda, ammonia, acids or chlorides
- cleaning agents containing descaling agents
- abrasive cleaning agents, e.g. powder cleaners and cream cleaners
- solvent-based cleaning agents
- stainless steel cleaning agents
- dishwasher cleaner
- oven sprays
- glass cleaning agents
- hard, abrasive sponges and brushes, e.g. pot scourers
- melamine eraser blocks
- sharp metal scrapers

We recommend using a clean sponge, lukewarm water with a little washing-up liquid to clean surfaces of the appliance.

The following pages contain important information on cleaning.

Cleaning and care

Preparing the refrigeration appliance for cleaning

- Switch the refrigeration appliance off.

The display goes out and the cooling function is switched off.

- Take any food out of the refrigeration appliance and store it in a cool place.
- Remove the shelves and bottle shelf from the door.
- Take out the freezer drawers.
- Take out all other removable parts for cleaning.

Dismantling an adjustable shelf

- Place the shelf on a worktop covered with a soft material (e.g. a tea towel).

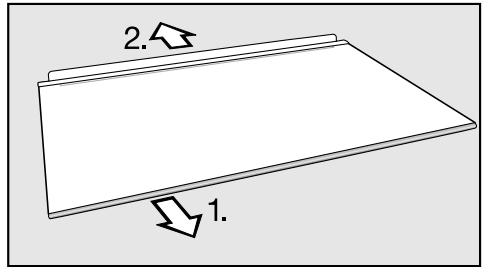

- Before cleaning the shelf remove the plastic trim and protective strip at the back of the shelf as follows:
 1. First pull the plastic trim off, starting from one side.
 2. Then pull the protective strip off.
- After cleaning the shelf reattach the plastic trim and the protective strip.

Cleaning the interior and accessories

The refrigeration appliance should be cleaned regularly (at least once a month).

Remove soiling immediately to prevent it from drying on.

- Clean the **interior** with a clean sponge, lukewarm water and a little washing-up liquid.
- After cleaning, wipe with clean water and dry with a soft cloth.

Remove the plastic trims before cleaning the adjustable shelves and door shelves in a dishwasher.

The following parts **cannot be cleaned in a dishwasher**:

- the plastic trim
- all drawers and the compartment lid (depending on model)
- the bottle rack
- These accessories should all be hand washed.

 Risk of damage as a result of excessively high dishwasher temperatures.

Parts of the refrigeration appliance may become unusable, e.g. deform, if they are washed in the dishwasher at more than 55 °C.

For dishwasher-safe parts, only use dishwasher programmes with a maximum temperature of 55 °C.

Contact with natural dyes from carrots, tomatoes and ketchup, etc., may discolour the plastic parts in the dishwasher. This discolouration does not affect the stability of the parts.

The following parts **can be cleaned in the dishwasher**:

- the bottle holder, egg tray, ice cube tray (depending on model)
- the shelves and bottle shelf in the door (with plastic trim removed)
- the adjustable shelves (with the trim/strips removed and without the printing)
- the holder for the charcoal filter (available as an optional accessory)
- Clean the condensate channel and drain hole frequently so that condensate can drain away unhindered. Use a straw or similar to clear the drain if necessary.
- Leave the door open to air the appliance for a short while and to prevent odours building up.

Cleaning and care

Cleaning the front of the appliance and the side panels

If soiling is left on for any length of time, it may become impossible to remove. Surfaces may suffer discolouration or damage. Therefore, it is best to remove soiling from the appliance front and side panels immediately.

All surfaces are susceptible to scratching. Contact with unsuitable cleaning agents can alter or discolour the surfaces. See the information on “Cleaning agents” at the beginning of this section.

- Clean the surfaces with a clean sponge and a solution of warm water and washing-up liquid. A clean, damp microfibre cloth without cleaning agent can also be used.
- After cleaning, wipe with clean water and dry with a soft cloth.

Stainless steel appliances

Appliance front

 Risk of damage as a result of incorrect cleaning.

The front finish (CleanSteel) will be damaged.

Do not use a stainless steel cleaning agent on this surface.

The appliance front has a high quality, special finish (CleanSteel). It is resistant to soiling and is very easy to clean.

Cleaning the ventilation gaps

A build-up of dust will increase the energy consumption of the appliance.

- The ventilation gaps should be cleaned on a regular basis with a brush or vacuum cleaner (you could use a Miele vacuum cleaner dusting brush, for example).

Cleaning the compressor and metal grille at the back of the appliance

A build-up of dust will increase the energy consumption of the appliance.

 Risk of damage as a result of incorrect cleaning.

Cables and other components can get broken off, bent or damaged. Carefully clean the compressor and metal grille.

The compressor and metal grille at the back of the refrigeration appliance (heat exchanger) should be dusted at least once a year.

Cleaning the door seal

If the door seal is damaged or has slipped out of its groove, the appliance door may not close properly and cooling performance will be reduced. As a result, condensate will build up in the interior cabinet and this can cause a build-up of ice.

Do not damage the door seal and ensure it does not slip out of its groove.

 Risk of damage as a result of incorrect cleaning.

If you treat the door seal with oils or grease, it can become porous. Do not use any oils or grease on the door seal.

- The door seal should be cleaned regularly with clean water and then wiped dry with a cloth.

Cleaning and care

After cleaning

- Replace all shelves and accessories in the appliance.
- Switch the refrigeration appliance on.
- Switch on the Super freeze function for a while so that the freezer section can cool down quickly.
- Place food in the refrigerator section and close the door.
- Place the freezer drawers with the frozen food back in the freezer section and close the door.
- When the temperature in the freezer section is a constant $-18\text{ }^{\circ}\text{C}$ or colder press the Super freeze button to switch the Super freeze function off.

Replacing the charcoal filters

Charcoal filters and a KKF-FF (Active AirClean) holder are available as optional accessories (see “Accessories - optional accessories”).

Replace the charcoal filters in the holder every 6 months.

Replacement KKF-RF charcoal filters can be obtained from the Miele Customer Service Department, from your retailer or from Miele's website.

Tip: The charcoal filter holder is dishwasher-safe.

- Pull the charcoal filter holder upwards to remove it from the adjustable shelf.

When in position, the charcoal filters must not touch the rear wall of the refrigeration appliance as the moisture could cause them to stick to it.

Insert the new charcoal filters deep enough in the holder to ensure that they do not protrude over the edge of the holder.

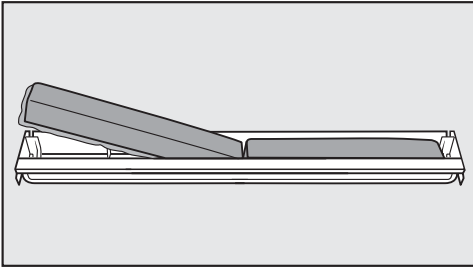

- Remove both charcoal filters and place the new filters with the surrounding edge pointing downwards in the holder.

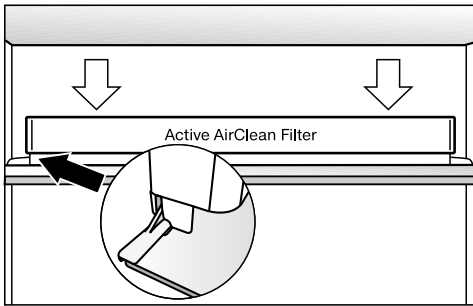

- Place the holder in the middle of the raised edge at the back of the adjustable shelf, so that it clicks into position.

Problem solving guide

Many malfunctions and faults that can occur in daily operation can be easily remedied. Time and money will be saved because a service call will not be needed.

The following guide may help you to find the reason for a malfunction or a fault, and to correct it.

To prevent unnecessary loss of temperature it is advisable not to open the door while waiting for the appliance to be serviced.

Problem	Cause and remedy
The appliance is not getting cold and the interior lighting does not come on when the door is opened.	The appliance has not been switched on. ■ Switch the appliance on.
	The plug is not inserted in the socket correctly. ■ Insert the plug into the socket correctly and switch on.
	Check whether the mains fuse has tripped. There could be a fault with the appliance, the household electrical wiring or another electrical appliance. ■ Contact a qualified electrician or Miele.
The compressor is switching on more frequently and for longer periods of time. The temperature in the refrigeration appliance is too low.	The ventilation gaps have been covered or become too dusty. ■ Do not block the ventilation gaps. ■ Dust the ventilation gaps regularly.
	The appliance doors have been opened too frequently, or a large amount of fresh food has been put in all at once for storage or freezing. ■ Only open the appliance doors when necessary and for as short a time as possible. After a while, the temperature will return to normal by itself.
	The appliance doors are not closed properly. A thick layer of ice may have formed in the freezer section. ■ Close the appliance doors.



Problem solving guide

Problem	Cause and remedy
	<p>After a while, the temperature will return to normal by itself.</p> <p>If a thick layer of ice has already formed, this will affect cooling and increase energy consumption.</p> <ul style="list-style-type: none"> ■ Defrost the refrigeration appliance and clean it. <p>The ambient room temperature is too high. The higher the ambient temperature, the longer the compressor has to run.</p> <ul style="list-style-type: none"> ■ See the information in “Installation – Installation site”. <p>The temperature setting in the refrigeration appliance is too low.</p> <ul style="list-style-type: none"> ■ Correct the temperature setting. <p>A large amount of food is being frozen at once.</p> <ul style="list-style-type: none"> ■ See “Freezing and storing food”. <p>The SuperFreeze function is still switched on.</p> <ul style="list-style-type: none"> ■ You can switch off the SuperFreeze function earlier to save energy.
<p>The compressor comes on less and less often and for shorter periods of time. The temperature in the refrigeration appliance rises.</p>	<p>Not a fault. The temperature setting is too high.</p> <ul style="list-style-type: none"> ■ Correct the temperature setting. ■ Check the temperature again after 24 hours. <p>The frozen goods begin to defrost.</p> <p>The room temperature is too low for this refrigeration appliance.</p> <p>If the room temperature is too low, the compressor will run less frequently. This may cause the freezer section to become too warm.</p> <ul style="list-style-type: none"> ■ See the information under “Installation – Location”. ■ Increase the temperature of the room.
<p>The compressor runs continuously.</p>	<p>This is not a fault. To save energy, the compressor runs at a lower speed, but for longer, when less cooling is required.</p>
<p>The door seal is damaged or needs to be replaced.</p>	<p>No tools are required to change the door seal.</p> <ul style="list-style-type: none"> ■ Change the door seal. A replacement is available from Miele or from specialist retailers.

Problem solving guide



Problem	Cause and remedy
Ice or condensation has built up inside the refrigeration appliance. The appliance door may not close correctly.	The door seal has come out of its groove. ■ Check that the door seal is correctly positioned in the groove.
	The door seal is damaged. ■ Check whether the door seal is damaged.

Display warnings

Message	Cause and remedy
<p>The alarm symbol  and the temperature display are flashing.</p>	<p>The temperature alarm has been activated (see “Temperature and door alarm”). The temperature in the freezer section has risen higher or fallen lower than the temperature set.</p> <p>Possible reasons for this include:</p> <ul style="list-style-type: none"> – The appliance door has been opened too frequently. – A large quantity of fresh food has been placed in the freezer without switching on the SuperFreeze function. – A prolonged power cut (mains outage) has occurred. <p>■ Rectify the cause of the alarm.</p> <p>The alarm will stop and the alarm symbol  will go out when the temperature reaches the correct level again.</p> <p>■ Depending on the temperature displayed, you should check whether food in the freezer has started to thaw or has defrosted. If it has, it should be used as soon as possible. Defrosted food may only be re-frozen after it has been cooked.</p>
<p>“F0 to F9” appears in the display.</p>	<p>There is a fault.</p> <p>■ Call the Miele Service Department.</p>
<p>The  symbol lights up in the display, the appliance does not get cold, although the controls and the interior lighting are working.</p>	<p>Demo mode is switched on. This allows the appliance to be presented in the showroom without the cooling system being switched on. Do not activate this setting for domestic use.</p> <p>■ Contact the Miele Service Department for information on deactivating Demo mode.</p>

Problem solving guide

The interior lighting is not working.

Problem	Cause and remedy
The interior lighting is not working.	<p>The appliance or the refrigerator section has not been switched on.</p> <ul style="list-style-type: none">■ Switch the refrigeration appliance or the refrigerator section on.
	<p>Sabbath mode is switched on: the display is dark and the refrigeration appliance is cooling.</p> <ul style="list-style-type: none">■ Press the SuperFreeze button briefly to leave Sabbath mode. <p>The temperature will then appear in the display and the interior lighting will come on (see “Selecting further settings” – “Switching Sabbath mode on/off”).</p>
	<p>To avoid overheating, the lighting switches itself off automatically after approx. 15 minutes if the door is left open. If this is not the case, then there is a fault.</p> <div data-bbox="404 743 1039 1002" style="border: 1px solid gray; padding: 5px;"><p> Risk of electric shock due to exposed, live electrical components.</p><p>When removing the lighting cover, there is a risk of coming into contact with live electrical components.</p><p>Do not remove the lighting cover. The LED lighting may only be repaired or replaced by Miele Service.</p></div>
	<div data-bbox="404 1015 1039 1238" style="border: 1px solid gray; padding: 5px;"><p> Danger of injury from LED lighting.</p><p>This lighting corresponds to risk group RG 2. If the cover is defective, there is a danger of eye injury.</p><p>If the lighting cover is defective, do not look from a close range directly into the lighting with optical instruments (e.g. magnifying glass or similar).</p></div> <ul style="list-style-type: none">■ Call Miele Service.

Other problems

Problem	Cause and remedy
The door to the freezer will not open because it has been opened and closed too many times in succession.	This is not a fault. The suction caused by opening and closing the door is preventing the door from opening. Wait approx. 1 minute and then try again. It should now open without force.
Food has frozen together.	The food packaging was not dry when placed in the freezer. ■ Use a blunt instrument, e.g. a spoon handle or plastic scraper, to prise it apart carefully.
The external walls of the appliance feel warm.	This is not a fault. The heat created by the evaporator is used to prevent condensation.

Noises

Normal noises	What causes them
Brrrrr ...	A humming noise is made by the motor (compressor). This noise can get louder for brief periods when the motor switches on.
Blubb, blubb ...	A gurgling noise can be heard when coolant is circulating through the pipes.
Click ...	Clicking sounds are made when the thermostat switches the motor on and off.
Sssrrrrr ...	You can sometimes just hear the sound of the fan inside the appliance.
Crack ...	A cracking sound can be heard when materials expand inside the appliance.
Remember that the noise of the compressor and the coolant circulating in the system is unavoidable.	

Noises	Cause and remedy
Rattling, vibrating	The appliance is uneven. Realign the appliance using a spirit level. Do so by raising or lowering the screw feet underneath the appliance or place something underneath it.
	The appliance is touching another appliance or piece of furniture. Move it away.
	Drawers or shelves are unstable or sticking. Check all removable items and refit them correctly.
	Bottles or containers are touching each other. Separate them.
	The transport cable clips are hanging loose at the back of the appliance. Remove them.

Contact in the event of a fault

In the event of any faults which you cannot remedy yourself, please contact your Miele dealer or the Miele Customer Service Department.

You can book a Miele Customer Service Department call-out online at www.miele.com/service.

Contact information for the Miele Customer Service Department can be found at the end of this document.

Please quote the model identifier and serial number of your appliance (Fabr./SN/Nr.) when contacting the Miele Customer Service Department. This information can be found on the data plate.

Please note that telephone calls may be monitored and recorded for training purposes and that a call-out charge will be applied to service visits where the problem could have been resolved as described in this booklet.

The data plate can be found inside the appliance.

EPREL database

From 1 March 2021, information on energy labelling and ecodesign requirements will be available in the European Product Database (EPREL). You can find the product database at the following link <https://eprel.ec.europa.eu/>. You will be asked to enter the model identifier.

The model identifier can be found on the data plate.



XXXXXX ← Nr. XX/XXXXXXXXXX.

WEINTEMPERERSCHRANK-INTERTECHNICHELL
 MULTITEMPERATURE WINE STORAGE CABINET-UNDERA/WORKTOP
 ARMOIRE DE MISE EN TEMP. DES VINS/MCO. ENCASTRABLE SOUS PLAN
 ARMARIO PLACONCONDICIONATO. VINGO/MCOEN/POTRBAJO ENMERA
 БИРНИК/ТЕМПЕРИТУРА ШИШ/УК/49

Klasse/Class Classe/Clase SN-ST	Ap-Type/AP-Type AP-Type/AP-Type	Bruttinhalt/Gross Capacity Volume Brut/Capacità Bruta	Gefriervermögen/Freezing Capacity Pouvoir de Congel/Capac. Congeladora
Nutzinhalt Net Capacity Volume Utile Capac. Util			R600a: XXg
Ges /K /G /WINE /KALT Tot /R /F /WINE /CHILL			
	Tot /R /F /C Tot /F /C /WINE /CHILL		

Warranty

The appliance warranty is valid for 2 years from date of purchase. In the UK, you must activate your cover by calling 0330 160 6640 or registering online at www.miele.co.uk.

For more information on country-specific warranty terms and conditions, please contact Miele Customer Service.

Installation

Installation

 Fire risk and risk of damage from appliances which give off heat. Appliances which give off heat can catch fire and set fire to the refrigeration appliance. Do not place appliances which give off heat, such as mini-ovens, double burner hobs or toasters on the refrigeration appliance.

 Fire risk and danger of damage from open flames. Open flames can set fire to the refrigeration appliance. Keep open flames (e.g. a candle) away from the refrigeration appliance.

Side-by-side installation

 Risk of damage due to condensation on external appliance panels. In environments with high humidity, condensation can build up on external appliance panels, which can cause corrosion. Do not place different refrigeration appliance models directly next to or on top of one other.

Your refrigeration appliance must not be installed “side-by-side” because it is not equipped with built-in heating units in the side panels.

If you want to place several refrigeration appliances next to each other, a distance of 100 mm must be maintained between them.

Please contact your dealer for specific information about which combinations will work with your appliance.

Location

This appliance should be installed in a dry, well-ventilated room.

When deciding where to install your refrigeration appliance please bear in mind that it will use more energy if installed near to a heater, a cooker or other appliance that gives off heat. Direct sunlight should also be avoided. The higher the room temperature, the longer the compressor runs and the higher the energy consumption is.

When installing the appliance, please note:

- The socket must be easily accessible in an emergency, not concealed behind the appliance.
- The plug and cable must not touch the rear of the appliance as they could be damaged by vibrations from the appliance.
- Do not plug in other appliances behind this appliance.

 Risk of damage due to corrosion. In environments with high humidity, condensation can build up on external refrigeration appliance panels. This condensate can cause corrosion on external appliance panels.

Install the refrigeration appliance in a dry and/or air-conditioned room with sufficient ventilation.

After installation, make sure that the appliance doors close properly, the ventilation gaps are not covered and that the refrigeration appliance has been installed in accordance with these installation instructions.

Climate range

This refrigeration appliance is designed for use within specific ambient temperatures (climate range). Do not use in ambient temperatures for which it is not designed. The climate range is stated on the data plate in the interior cabinet of the refrigeration appliance.

Climate range	Ambient temperature
SN	+10 to +32 °C
N	+16 to +32 °C
ST	+16 to +38 °C
T	+16 to +43 °C

A lower ambient temperature leads to the compressor switching off for longer periods. This can cause the internal temperature in the refrigeration appliance to rise with the risk of food deteriorating and going off.

Installation

Ventilation

⚠ Risk of fire and damage due to insufficient ventilation.

If the refrigeration appliance is not ventilated sufficiently, the compressor will run more frequently and for longer periods. This will result in increased energy consumption and a higher operating temperature for the compressor. This may, in turn, cause damage to the compressor.

Please ensure that there is adequate ventilation around the refrigeration appliance.

It is essential to observe the required ventilation gaps.

The ventilation gaps must not be covered or blocked in any way.

They must also be regularly dusted.

Air at the back of the refrigeration appliance gets warm.

Fitting wall spacers supplied

The wall spacers supplied must be used in order to achieve declared energy consumption values and to prevent the build-up of condensation at high ambient temperatures. Appliance depth is increased by approx. 35 mm with the wall spacers fitted. If the wall spacers are not used the functionality of the appliance is not affected. Energy consumption is only slightly increased with less distance between the appliance and the wall.

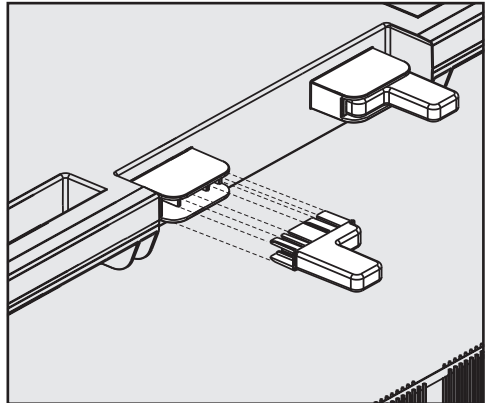

- Fit the wall spacers onto the back of the appliance in between the transport handles.

Installing the refrigeration appliance

 Danger of injury and damage due to the refrigeration appliance tipping over.

There is an increased danger of injury and damage if the refrigeration appliance is installed by a single person.

Two people are required for installing the refrigeration appliance.

 Risk of damaging the floor.

Moving the refrigeration appliance can cause damage to the floor. Move the refrigeration appliance carefully on floors that are sensitive to scratching.

For easier installation there are transport handles on the back at the top and transport wheels underneath the refrigeration appliance.

Tip: The refrigeration appliance must be empty when it is installed.

- Prepare the refrigeration appliance for installation as close as possible to its intended installation location.
- Release the mains cable from the back of the appliance.
- Remove the cable clip from the back of the appliance.
- Move the refrigeration appliance carefully to its intended installation location.
- Position the refrigeration appliance with the wall spacers (if used) or the back close to the wall.

Aligning the appliance

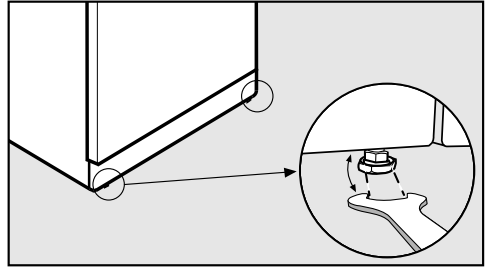

- To align the appliance, adjust the front feet using the spanner supplied

Levelling the appliance door

 Risk of damage and injury caused by the appliance door falling out or the refrigeration appliance tipping over.

If the additional adjustable foot ① on the hinge plate at the bottom is not resting firmly on the floor, the appliance door can fall out or the refrigeration appliance can tip over.

Use the open spanner supplied with the appliance to unscrew the adjustable foot until it is resting on the floor.

Then unscrew the adjustable foot by a further quarter turn.

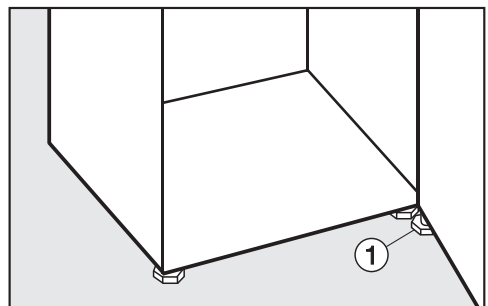

Installation

Installing the refrigeration appliance in a run of kitchen units

⚠ Risk of fire and damage due to insufficient ventilation.

If the refrigeration appliance is not ventilated sufficiently, the compressor will run more frequently and for longer periods. This will result in increased energy consumption and a higher operating temperature for the compressor. This may, in turn, cause damage to the compressor.

Please ensure that there is adequate ventilation around the refrigeration appliance.

It is essential to observe the ventilation gaps given. The ventilation gaps must not be covered or blocked in any way.

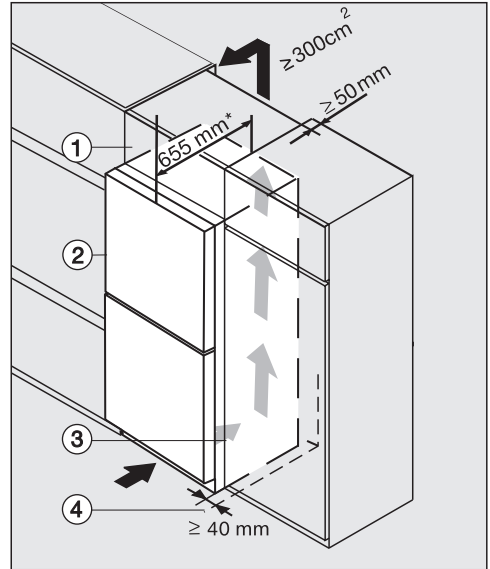

- ① Top box
- ② Refrigeration appliance
- ③ Housing unit
- ④ Wall

* The appliance depth is increased by approx. 35 mm for refrigeration appliances with wall spacers fitted.

The refrigeration appliance can be built into a kitchen run and installed directly next to a kitchen furniture housing unit. The appliance front must protrude in front of furniture fronts by at least 65 mm. This enables the doors to be opened and shut without being obstructed. To match the height of the rest of the kitchen, the refrigeration appliance can be fitted with a suitable top box ①.

When installed next to a wall ④, a distance of at least 40 mm must be maintained on the hinge side between the wall ④ and the refrigeration appliance ②.

The larger the ventilation gap, the more economically the compressor will work.

- A ventilation gap of at least 50 mm depth must be provided at the back of the refrigeration appliance behind the whole width of the top box for air to circulate.
- The ventilation gap under the ceiling must be at least 300 cm² to ensure that warm air can escape without obstruction.

Installation

Appliance dimensions

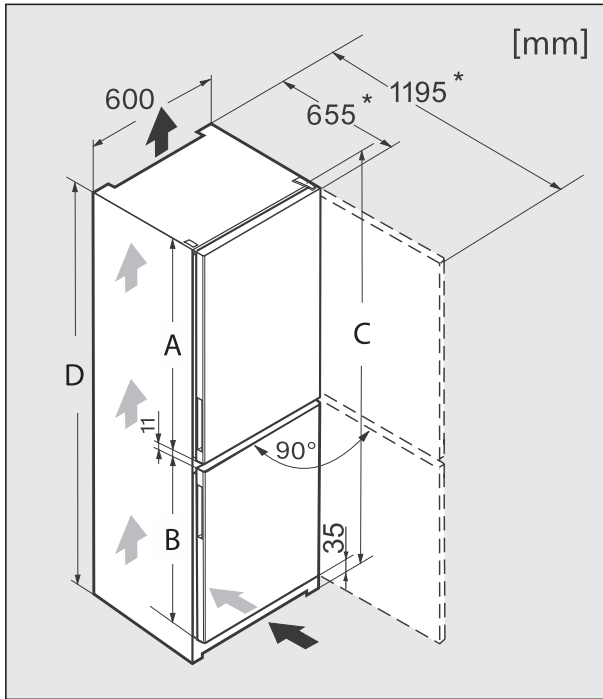

* Dimensions without wall spacers fitted. Appliance depth is increased by 35 mm with the wall spacers supplied fitted.

	A [mm]	B [mm]	C [mm]	D [mm]
KFN 29162 D ws	1201	750	2011	2000
KFN 29162 D edt/cs	1201	750	2011	2000

Changing the door hinging

The refrigeration appliance is supplied with hinges on the right. If left-hand hinging is required, the hinges must be changed.

 Always change the door hinging with the assistance of another person.

If the door seal is damaged or has slipped out of its groove, the door will not close properly and cooling performance will be reduced. Condensate will build up in the interior and this can cause a build-up of ice.
Do not damage the door seal and ensure it does not slip out of its groove.

Preparing to change the door hinging

To change the door hinging, you will need the following tools:

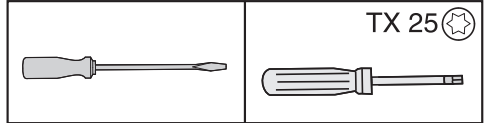

The following tool is supplied:

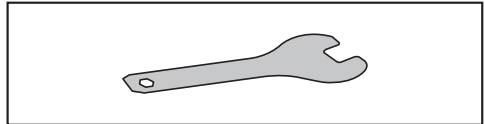

- Place a suitable cover on the floor in front of the appliance to protect the appliance doors and your floor from damage.
- Remove the shelves/bottle shelf from the appliance door.

Installation

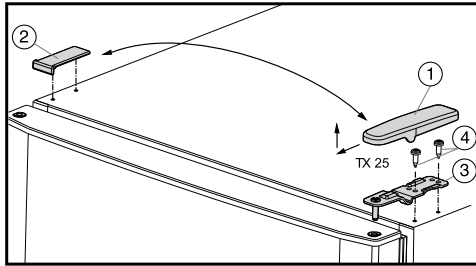

- Pull the cover ① forwards and then lift it off.
- Remove the cover ②.

⚠ Danger of injury when removing the appliance door.
The appliance door is not secure once the screws in the hinge plate have been removed.
Hold the appliance door firmly.

- Undo the screws ④ and remove the hinge plate ③.
- Lift the upper door off and place it carefully to one side.

- Open the lower door.

⚠ Danger of injury when removing the appliance door.
The appliance door is not secure once the screws in the hinge plate have been removed.
Hold the appliance door firmly.

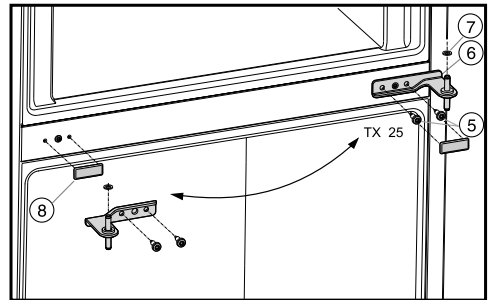

- Undo the screws ⑤ and remove the hinge plate ⑥. Then pull it out of the bearing bush in the lower door.
- Remove the plastic disc ⑦.
- Lift the lower door off and place it carefully to one side.
- Carefully lever cover ⑧ off.
- Refit cover ⑧ on the opposite side.

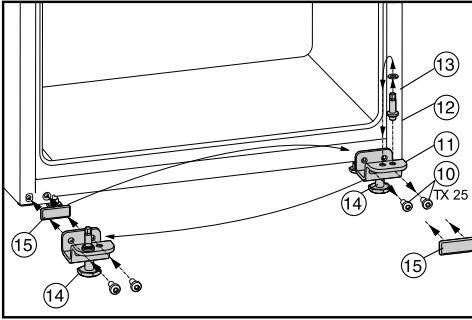

- Undo the screws ⑩ and remove lower hinge plate ⑪ together with hinge pin ⑫, plastic disc ⑬ and the adjustable foot ⑭.
 - Unscrew the hinge pin ⑫ together with plastic disc ⑬, and screw back into the opposite hole in the the hinge plate.
 - Carefully remove cover ⑮ and refit on the opposite side.
 - Screw the lower hinge plate ⑪ together with hinge pin ⑫, plastic disc ⑬ and the adjustable foot ⑭ in on the opposite side.
 - Lower the lower door onto the hinge pin ⑫.
 - Close the appliance door.
 - Fit hinge plate ⑥ turned through 180° into the bearing bush in the lower door. Important! Make sure the plastic disc ⑦ is fitted back on the hinge pin.
 - Then screw the hinge plate ⑥ on securely with screws ⑤.
 - Place the upper door onto the hinge pin from above.
- Fit hinge plate ③ turned through 180° into the bearing bush in the upper door.
 - Then screw the hinge plate on securely with screws ④.
 - Fit cover ① back onto the opposite site. It will click into position.
 - Fit cover ② back onto the opposite site. It will click into position.
 - Unscrew adjustable foot ⑭ from the lower hinge plate until it sits on the floor.

Installation

Electrical connection

The appliance is supplied with a mains cable and moulded plug ready for connection to an AC single-phase 220–240 V 50 Hz supply.

The fuse rating must be at least 10 A.

This appliance must be connected to a suitable switched socket. The electrical installation must be in compliance with current local and national safety regulations, (e.g. VDE 0100 in Germany / BS 7671 in the UK). We recommend the use of a suitable RCD



The socket must not be concealed behind the appliance and must be easily accessible so that the appliance can be quickly disconnected from the electrical supply in case of an emergency.

If the socket is no longer accessible after installation, an additional means of disconnection must be provided for all poles. Suitable means of disconnection include switches with an all-pole contact gap of at least 3 mm. These include miniature circuit breakers, fuses and contactors (EN 60335).

The mains plug and mains connection cable must not come into contact with the back of the appliance as vibrations can cause damage to these components. This could result in a short circuit.

Do not plug in other appliances behind this appliance.

Do not connect the appliance to the mains electricity supply by an extension lead. Extension leads do not guarantee the required safety of the appliance (e.g. danger of overheating).

Do not connect the appliance to a stand-alone inverter such as those used with an autonomous energy source e.g. **solar power**.

When the appliance is switched on, power surges could result in a safety switch-off. This could damage the electronic module. The appliance must not be used with so-called **energy saving devices** either. These reduce the amount of energy supplied to the appliance, causing it to overheat.

If the mains cable needs to be replaced, this must be performed by a qualified electrician.

United Kingdom

Miele Co. Ltd., Fairacres, Marcham Road, Abingdon, Oxon, OX14 1TW

Tel: 0330 160 6600, Internet: www.miele.co.uk/service, E-mail: info@miele.co.uk

Australia

Miele Australia Pty. Ltd.

ACN 005 635 398

ABN 96 005 635 398

1 Gilbert Park Drive

Knoxfield, VIC 3180

Tel: 1300 464 353

Internet: www.miele.com.au

China Mainland

Miele Electrical Appliances Co., Ltd.

1-3 Floor, No. 82 Shi Men Yi Road
Jing' an District

200040 Shanghai, PRC

Tel: +86 21 6157 3500

Fax: +86 21 6157 3511

E-mail: info@miele.cn,

Internet: www.miele.cn

Hong Kong, China

Miele (Hong Kong) Ltd.

41/F - 4101, Manhattan Place

23 Wang Tai Road

Kowloon Bay, Hong Kong

Tel: (852) 2610 1025

Fax: (852) 3579 1404

Email:

customerservices@miele.com.hk

Website: www.miele.hk

India

Miele India Pvt. Ltd.

1st Floor, Copia Corporate Suites,
Commercial Plot 9,

Mathura Road, Jasola,

New Delhi - 110025

E-mail: customercare@miele.in

Website: www.miele.in

Ireland

Miele Ireland Ltd.

2024 Bianconi Avenue

Citywest Business Campus

Dublin 24

Tel: (01) 461 07 10

Fax: (01) 461 07 97

E-Mail: info@miele.ie

Internet: www.miele.ie

Malaysia

Miele Sdn Bhd

Suite 12-2, Level 12

Menara Sapura Kencana

Petroleum

Solaris Dutamas No. 1

Jalan Dutamas 1

50480 Kuala Lumpur, Malaysia

Phone: +603-6209-0288

Fax: +603-6205-3768

New Zealand

Miele New Zealand Limited

IRD 98 463 631

8 College Hill

Freemans Bay, Auckland 1011

New Zealand

Tel: 0800 464 353

Internet: www.miele.co.nz

Singapore

Miele Pte. Ltd.

29 Media Circle

#11-04 ALICE@Mediapolis

Singapore 138565

sTel: +65 6735 1191

Fax: +65 6735 1161

E-Mail: info@miele.com.sg

Internet: www.miele.sg

South Africa

Miele (Pty) Ltd.

63 Peter Place

Bryanston 2194

P.O. Box 69434

Bryanston 2021

Tel: (011) 875 9000

Fax: (011) 875 9035

E-mail: info@miele.co.za

Internet: www.miele.co.za

Thailand

Miele Appliances Ltd.

BHIRAJ TOWER at EmQuartier

43rd Floor Unit 4301-4303

689 Sukhumvit Road

North Klongton Sub-District

Vadhana District

Bangkok 10110, Thailand

United Arab Emirates

Miele Appliances Ltd.

Showroom 1

Eiffel 1 Building

Sheikh Zayed Road, Umm Al Sheif

P.O. Box 114782 - Dubai

Tel. +971 4 3044 999

Fax. +971 4 3418 852

800-MIELE (64353)

E-Mail: info@miele.ae

Website: www.miele.ae

Manufacturer: Miele & Cie. KG, Carl-Miele-Straße 29, 33332 Gütersloh, Germany

KFN 29162 D ws, KFN 29162 D edt/cs

en-GB, IE, ZA

M.-Nr. 11 240 120 / 01