

**Installation instructions
and User guide**

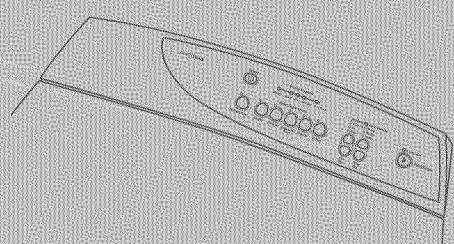

Smartload™ clothes dryer

US CA (EN)

WARNING: For your safety the information in this manual must be followed to minimize the risk of fire or explosion or to prevent property damage, personal injury or death.

—Do not store or use gasoline or other flammable vapors and liquids in the vicinity of this or any other appliance.

—WHAT TO DO IF YOU SMELL GAS

- Do not try to light any appliance.
- Do not touch any electrical switch; do not use any phone in your building.
- Clear the room, building or area of all occupants.
- Immediately call your gas supplier from a neighbor's phone. Follow the gas supplier's instructions.
- If you cannot reach your gas supplier, call the fire department.

—Installation and service must be performed by a qualified installer, service agency or the gas supplier.

The Governor of California is required to publish a list of substances known to the state of California to cause cancer or reproductive harm and requires business to warn customers of potential exposures to such substances.

WARNING!: Gas appliances contain or produce substances, which can cause death, or serious illness and which are known to the State of California to cause cancer, birth defects, or other reproductive harm. To reduce the risk from substances in fuel or from fuel combustion, make sure this appliance is installed, operated, and maintained according to the manufacturers instructions.

Contents

Dryer Safety	5
Important Safety Instructions	6
Warranty	8
Installation Instructions	9
Installer Responsibilities, Location Requirements	10
Dimensions	12
Mobile Home Installation	13
Venting	14
Alternative Installation for Close Clearances	18
Exhaust Venting	19
Installation	20
Grounding Instructions	22
Electrical Requirements	23
Gas Requirements	29
Level Machine, Final Installation Checklist	32
Features	33
Operating Instructions	34
Using Your Dryer	37
Drying Progress Lights	43
Lid Lock	44
Care Labels	45
Drying Special Items	46
Cleaning	48
If Your Dryer Beeps for Help	49
Trouble Shooting	50
Limited Warranty	52

Important!

SAVE THESE INSTRUCTIONS

The models shown in this User Guide may not be available in all markets and are subject to change at any time. For current details about model and specification availability in your country, please visit our local website listed on the back cover or contact your local Fisher & Paykel dealer.

Thank you for buying a Fisher & Paykel *Smartload™* dryer.

We hope you enjoy using the *Smartload™* dryer as much as we have enjoyed designing it. We've developed this dryer to treat your clothes with the utmost care, drying them gently so they will look better for longer. We know you'll enjoy the benefits of its easy loading drum, reverse tumbling and lint removal system.

Please take the time to read this User Guide carefully. It will help you to operate and maintain your new *Smartload™* dryer.

Your safety, and the safety of others is very important. Located on your dryer and throughout this guide are safety messages and instructions; it is important that you understand and follow them.

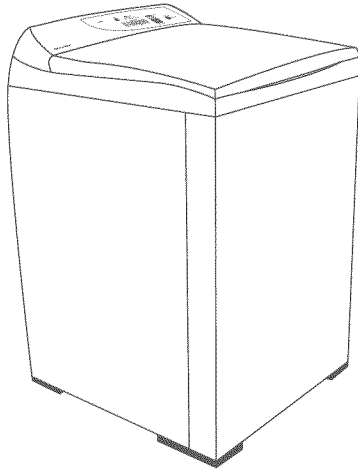

Dryer Safety

Symbols

Symbols will be used in this Guide to highlight when extra care is required. Abide by these at all times to ensure you and your family are not harmed while operating your dryer.

It is important to always act with caution and use common sense when operating your dryer. Use only as per instructed by the User Guide.



This is the safety alert symbol. This symbol alerts you to hazards that can kill or hurt you and others.

The safety alert symbol and the word DANGER or WARNING will precede all safety messages. These words mean:



You can be killed or seriously injured if you don't immediately follow instructions.



You can be killed or seriously injured if you don't follow instructions.

All safety messages will identify the hazard, tell you how to reduce the chance of injury, and tell you what can happen if the instructions are not followed.

Important Safety Instructions

WARNING



Electric Shock Hazard

**Follow the safety precautions outlined in this User Guide.
Failure to do so can result in death or electric shock.**

Safety Precautions

- Read all instructions carefully before using this dryer.
- Use this dryer only for its intended purpose as described in this User Guide.
- To minimize the possibility of electric shock, unplug this dryer from the power supply or disconnect the dryer at the household distribution panel (by removing the fuse or switching off the circuit breaker) before attempting any user maintenance or cleaning.
- Installations and service must be performed by a qualified or licensed contractor, plumber or gasfitter qualified or licensed by the state, province, or region where this appliance is being installed.
- This dryer must be properly installed and located in accordance with the Installation Instructions before it is used.
- This dryer must be properly grounded to conform with all governing codes and ordinances. Follow details in Installation Instructions.
- Do not install or store the dryer where it will be exposed to water or exposed to the weather.
- Connect to a properly protected, rated and sized power supply circuit to avoid electrical overload.
- Do not repair or replace any part of the appliance or attempt any servicing, unless specifically recommended in the published user repair instructions that you understand and have the skills to carry out.
- When disconnecting the dryer, pull by the plug rather than the cord or junction of the cord plug, to avoid damage to the cord or junction of the cord plug.
- Make sure the cord is located so that it will not be stepped on, tripped over or otherwise subject to stress or damage.
- Do not tamper with the controls or the lid lock.
- Note: Pressing the **POWER** button does NOT disconnect the dryer from the power supply, even though the lights are out.
- Do not operate this dryer if it is damaged, malfunctioning, partially disassembled or has missing or broken parts, including a damaged cord or plug.
- This dryer must be directly connected to an approved fixed electrical outlet. It cannot be plugged into an extension cord.

Important Safety Instructions

WARNING

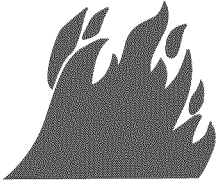

Fire Hazard

Only dry fabrics that have been washed with water.

Do not use heat to dry articles containing foam rubber or similarly textured rubber-like materials. Dry on the Air Dry cycle.

A clothes dryer produces combustible lint and must be exhausted outdoors. Take care to prevent the accumulation of lint around the exhaust opening and in the surrounding area.

Do not use fabric softeners or products to eliminate static unless recommended by the manufacturer of the fabric softener or product.

Failure to follow these instructions can result in death or personal injury.

To Reduce the Risk of Fire in a Tumble Dryer the Following Should be Observed:

- Do not place items in a tumble dryer that have previously been cleaned in, washed in, soaked in, or spot cleaned with flammable liquids or solids. They are a fire or explosion hazard. Highly flammable substances commonly used in domestic environments include acetone, denatured alcohol, gasoline, kerosene, some brands of spot removers and dry cleaning solvents, turpentine, waxes, wax removers, vegetable oil, fish oil, massage oil, and cooking oil.
- Do not leave hot oil-affected items in a pile or stack. This can prevent heat from escaping and can create a fire hazard. Oil-affected items can ignite spontaneously, especially when exposed to heat sources such as a tumble dryer. The items become warm causing an oxidation reaction in the oil. This oxidation creates heat. If the heat cannot escape the items can become hot enough to catch fire.
- Do not use heat to dry items containing rubber, foam rubber, plastic or similar materials, (such as padded bras, bath mats, rugs, bibs, baby pants, plastic bags, pillows etc), as these materials might melt or burn. Some rubber materials when heated can under certain circumstances produce fire by spontaneous combustion. Dry only on the **AIR DRY** cycle.
- Unless specifically recommended by their manufacturer, do not use fabric softeners or similar products in a tumble dryer.
- Do not store or use gasoline or other flammable gases and liquids near this or any other appliance.
- Keep the area around and underneath your dryer free from the accumulation of combustible materials such as lint, paper, rags, chemicals etc.
- Do not store any items that may burn or melt (such as paper materials, plastics or plastic containers etc) next to the dryer.
- Empty the lint bucket before the lint reaches the top of the transparent section (usually once a week).

Important Safety Instructions/Warranty

- The dryer must be exhausted to the outside. Carefully follow the venting details in the Installation Instructions.
- Keep the floor around your dryer clean and dry to reduce the possibility of slipping.
- If your dryer is running and you want to unload or add clothes, press **START/PAUSE** and wait until the machine has unlocked the lid. Do not force it open.
- Do not reach into the appliance if the drum is moving.
- Close supervision is necessary if this dryer is used by or near children. Do not allow children to play inside, around or with this dryer or any other appliance.
- Never climb on, climb into, or stand on the dryer top, lid or drum.
- Undergarments that contain metal reinforcements should not be placed directly in the dryer. Damage to the dryer can result if the metal reinforcements come loose during drying.
- The interior of the appliance and exhaust duct should be cleaned periodically by qualified service personnel.
- Before the appliance is removed from service or discarded remove the lid and the drum door to the drying compartment.

SAVE THESE INSTRUCTIONS

Warranty

Your dryer has been made to the highest standards. Years of development and rigorous testing ensure that you have bought a world-class product, in the unlikely event that a problem should occur, refer to the Warranty section at the back of this Guide (refer to page 52).

If you have a problem with your dryer refer to our troubleshooting section. If your problem is not referenced, please always contact your Fisher & Paykel Authorized Service Agent or our Customer Care Center (Toll Free 1.888.9.FNPUSA (1.888.936.7872)) rather than attempting to fix it yourself.

Installation Instructions

⚠ WARNING! – Risk of fire

Clothes dryer installation must be performed by a qualified installer.

Install the clothes dryer according to the manufacturer's instructions and local codes.

Do not install a clothes dryer with flexible plastic venting materials. If flexible metal (foil type) duct is installed, it must be of a specific type identified by the appliance manufacturer as suitable for use with clothes dryers. Flexible venting materials are known to collapse, be easily crushed, and trap lint. These conditions will obstruct clothes dryer airflow and increase the risk of fire.

To reduce the risk of severe injury or death, follow all installation instructions.

SAVE THESE INSTRUCTIONS

Read the Important Safety Instructions on pages 6 – 8 before you start installing the dryer.

Check to make sure you have all the tools and parts necessary to correctly install this appliance.

Tools Required

- ¼" nut driver or socket wrench
- Phillips screwdriver
- Flat-blade screwdriver
- Adjustable wrench 8" or 10" (20cm or 25cm) for gas connections
- Pipe joint compound (pipe dope or tape) for gas pipe connections that is resistant to LP Propane, Butane and Natural Gas (Gas models only)
- Level
- Caulking gun and compound (for installing new exhaust vent)
- Gloves
- Safety glasses
- Knife
- Duct tape

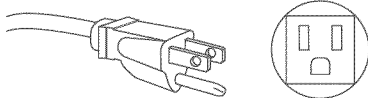

Parts Supplied

- 2 feet inserts for front feet.
 - A power supply cord is supplied already connected to the gas dryer (Gas models only)
- Check to make sure all parts have been supplied.

Accessories

- Mobile Home Installation Kit Part No 395488
- Natural Gas to LP Conversion Kit Part No 395489 (Gas models only)
- LP to Natural Gas Conversion Kit Part No 395490 (Gas models only)
- Kit Element 208V Part No 395500 (Electric models only)

Parts Needed

Check with local codes and read electrical, gas and venting requirements before purchasing parts. If you need to purchase a power supply cord kit or power supply cable, they must meet the requirements on page 24.

To the Installer

The correct installation of the dryer is your responsibility.

Be sure you read the following instructions carefully before you start to install the dryer. These instructions should be left with the home owner for future reference.

It is Your Responsibility to:

- Observe all governing codes and ordinances.
- Check code requirements. Some codes limit or do not permit installation of clothes dryers in garages, closets, mobile homes or sleeping quarters. Contact your local building inspector.
- Adhere to these installation instructions.
- Allow for spacing requirements with side by side installations (refer page 11).
- Make sure you have all items necessary for correct installation.
- Properly install the dryer.
- Contact a qualified installer to ensure that the electrical and gas installation meets all national and local codes and ordinances. (See page 6).

Location Requirements

WARNING

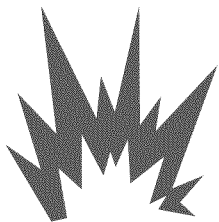

Explosion Hazard

Keep flammable materials and vapors, such as gasoline, away from the dryer.

Place dryer at least 18 inches (46 cm) above the floor for a garage installation.

Failure to do so can result in death, explosion, fire, or burns.

The dryer must be installed or stored in an area which is not exposed to water or weather.

It is extremely important that the dryer is installed in a well ventilated location. This dryer must exhaust air outdoors. Do not install the dryer in any room or closet which does not permit the free flow of replacement air.

The free area of any opening for the introduction of outside air shall not be less than twice the area of the dryer exhaust outlet.

Before installing the dryer ensure that there is sufficient height to fully open the lid. Allow sufficient room behind the dryer for the exhaust. The air intake is at the rear of the dryer. Ensure that there is a sufficient air passage on each side of the dryer for intake air.

Location Requirements

The area in which the dryer is located must be kept clear and free from combustible materials, gasoline and other flammable vapors and liquids. A dryer produces combustible lint so the area around the dryer must be cleaned regularly to keep it free of lint.

This dryer can only be vented from the rear and must be exhausted to the outdoors.

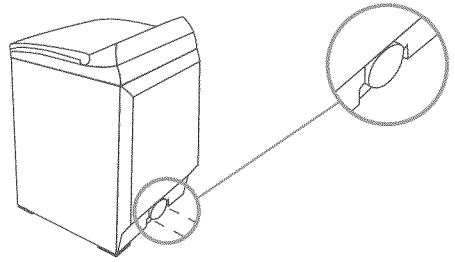

Alcove or Closet Installation



WARNING

When installing a dryer in a closet/alcove it must be exhausted to the outdoors. No other fuel burning appliance can be installed in the same closet or alcove.

The top opening area in the door must be a minimum of 48 square inches (310cm²) and the bottom opening area must have a minimum of 24 square inches (155cm²). These openings must never be obstructed (a louvred door with the minimum air opening is acceptable). Minimum installation clearances are required but more clearance is recommended.

11

Dimensions

Lid Clearance

Check that there is enough clearance for the lid to fully open.

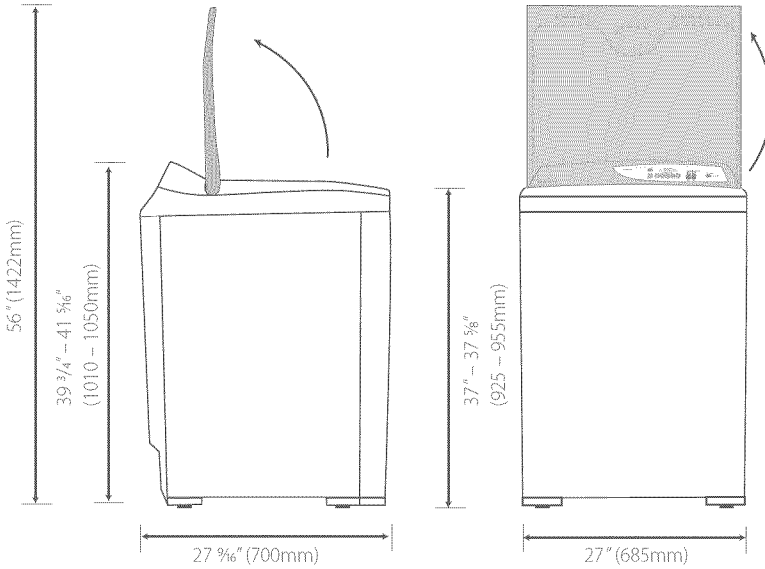

Exhaust Outlet Location

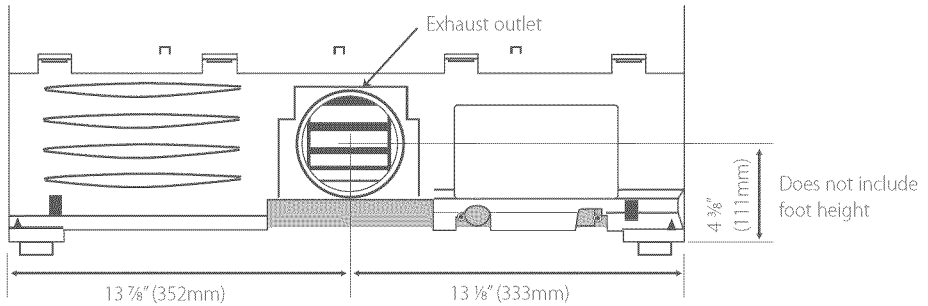

Dimensions

Mobile Home Installation

The installation of the dryer in a mobile home must conform to the Manufactured Home Construction and Safety Standard Title 24 CFR, Part 3280 {formerly the Federal Standard for Mobile Home Construction and Safety, Title 24 HUD (Part 280), 1975} for the United States or Standard CAN/CSA – Z240MH for Canada.

When installing a dryer in a mobile home, provisions for anchoring the dryer to the floor must be made.

A Mobile Home anchoring installation kit is available with instructions (see Accessories page 9). Locate in an area that has adequate outside make up air (a minimum of 72 square inches of unobstructed opening is required).

Mobile home installations must be exhausted to the outdoors with the exhaust duct termination securely fastened to the mobile home structure, using materials that will not support combustion.

The exhaust duct must not terminate beneath the mobile home. See the section on exhausting for more information.

The dryer must be exhausted outside

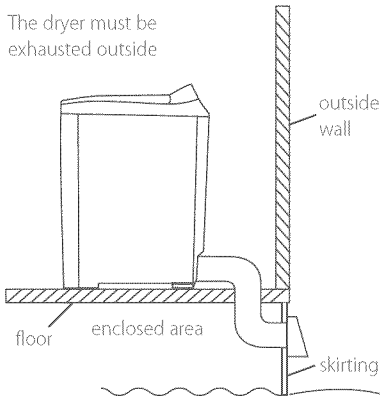

The exhaust vent must be securely fastened to a non-combustible portion of the mobile home structure and must not terminate beneath the mobile home.

Venting

WARNING

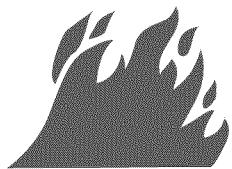

Fire Hazard

The dryer must be vented to the outdoors.

Use rigid or thick wall flexible metal exhaust duct only.

Do not use a plastic exhaust duct.

Do not use a metal foil exhaust duct.

Failure to follow these instructions can result in death or fire.

The dryer exhaust must be vented to the outdoors. This will prevent the build up of lint and moisture in the room in which it is located and reduce the risk of fire.

Exhaust ducting products can be purchased from your local Appliance store or Hardware store.

Never use plastic or metal foil flexible duct. This ducting can kink, sag, be punctured, reduce airflow, extend drying times and affect dryer operation.

A minimum of 4 inch (100 mm) thick wall flexible metal or rigid galvanised metal duct must be used. Using ducts larger than 4 inches (100 mm) diameter may result in more lint accumulating. In Canada, the exhaust duct must be 4.02 inches (102 mm) in diameter.

Using straight rigid metal ducting will minimize lint accumulation. Thick wall flexible metal ducting may be used but care must be exercised to avoid sharp bends which may squash the duct and cause blockages.

Use duct tape to secure joints. Do not use screws or any other fastening device which will extend into the duct, as they will collect lint.

Keep ducting as short and straight as possible. Do not exceed the maximum exhaust duct lengths stated later in these installation instructions. The total length of flexible metal duct used should be no longer than 94.5 inches (2.4 m).

Do not vent the dryer into any other duct, chimney or gas vent because accumulated lint and other material is a potential fire hazard. Do not vent the dryer into any ceiling, attic, crawl space, under-floor space, wall cavity, window well or any other concealed cavity that will accumulate lint.

Fit an exhaust hood with a swing-out damper to the outside end of the exhaust duct to prevent back drafts and entry of wild life. Never use exhaust hoods with a magnetic damper. The hood should have at least 12 inches (305 mm) clearance between the bottom of the hood and the ground or other obstruction. The hood opening should point down. Never install a screen over the exhaust outlet.

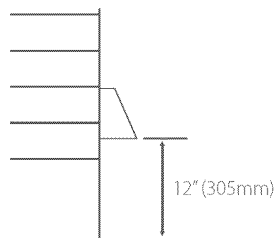

Venting

To reduce condensation, insulate any ducting which passes through unheated areas. Slope the duct gently downwards to the hood, to drain condensation and reduce lint build up. Avoid sag or loops in the duct as they may collect and store water and accumulate lint.

Before using an existing exhaust duct system for a dryer ensure that:

- No plastic or other potentially combustible duct or flexible metal foil ducting has been used.
- The duct is not pierced, kinked or crushed.
- The duct does not exceed the maximum recommended length for the new dryer.
- The exhaust hood damper opens and closes freely and with sufficient movement.
- Static pressure in the exhaust ducting does not exceed 1 inch of water column (250Pa), or is not less than 0 inches of water column (ie. negative pressure), when measured with a manometer in the 6 inches of the duct nearest the dryer, with the empty dryer running on Air Dry (no heat) setting.
- The exhaust duct system meets all relevant local, state and national codes.

All ducting should be inspected and cleaned at least once a year to remove accumulated lint. Frequently check that the damper on the exhaust hood moves sufficiently and opens and shuts freely.

Mobile Home Installations

A Mobile Home Installation Kit is available (see Accessories page 9 and notes page 13).

Determine Vent Duct Length

This dryer can only be vented from the rear and must be exhausted to the outdoors.

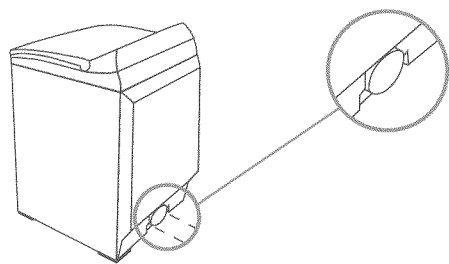

Different types of vent arrangements are shown below.

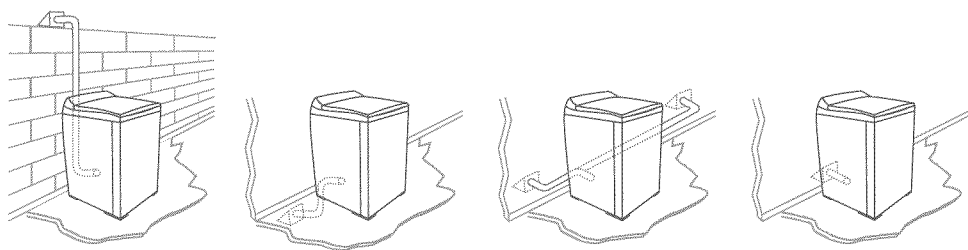

Venting

Choose a route that will provide the straightest and most direct path outdoors. Plan the installation to use the fewest number of elbows and turns.

When using elbows (rigid duct) or making turns (thick wall flexible metal duct), allow as much room as possible. With thick wall flexible metal duct bend duct gradually to avoid kinking and avoid 90° turns.

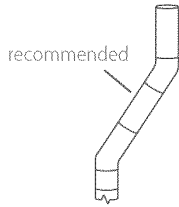

Maximum Length of Exhaust Duct

The maximum length of the exhaust duct system depends upon:

- The type of ducts (rigid or thick walled flexible metal).
- The number of elbows or bends used.

1 Refer to the exhaust duct length chart that matches your hood type for the maximum duct lengths you can use. Do not use duct runs longer than specified in the exhaust duct length charts (refer to next page).

Exhaust duct systems longer than specified will:

- Accumulate lint creating a potential fire hazard.
- Shorten the life of the dryer.
- Reduce performance, resulting in longer drying times and an increased energy usage.

2 Determine the number of elbows/bends you will need.

3 In the column listing the type of metal duct you are using (rigid or thick wall flexible metal), find the maximum length of metal duct on the same line as the number of elbows/bends to be used (refer to next page).

Maximum Length of Exhaust Duct

Preferred 4" Hoods

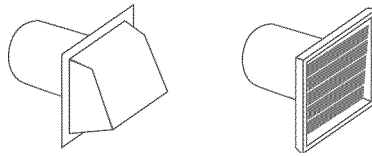

When you have a 4" (10cm) Hood

Number of 90° elbows/bends	Maximum length of 4" diameter metal duct.			
	Rigid		Thick Wall Flexible Metal (fully extended)	
0	64ft	19.5m	8ft	2.4m
1	54ft	16.5m	8ft	2.4m
2	44ft	13.4m	8ft	2.4m
3	35ft	10.6m	8ft	2.4m
4	27ft	8.2m	8ft	2.4m

Acceptable 2 1/2" Hood

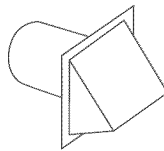

When you have a 2 1/2" (6cm) Hood

Number of 90° elbows/bends	Maximum length of 4" diameter metal duct.			
	Rigid		Thick Wall Flexible Metal (fully extended)	
0	58ft	17.6m	8ft	2.4m
1	48ft	14.6m	8ft	2.4m
2	38ft	11.5m	8ft	2.4m
3	29ft	8.8m	8ft	2.4m
4	21ft	6.4m	8ft	2.4m

For exhaust systems not covered by the exhaust duct length charts (such as multiple unit hook-ups, plenums, and power-assist fans), call our Customer Care Center: TOLL FREE 1.888.9.FNPUSA (1.888.936.7872).

Alternative Installation for Close Clearances

Venting systems come in many varieties. Select the type best for your installation.
A close-clearance installation is shown.

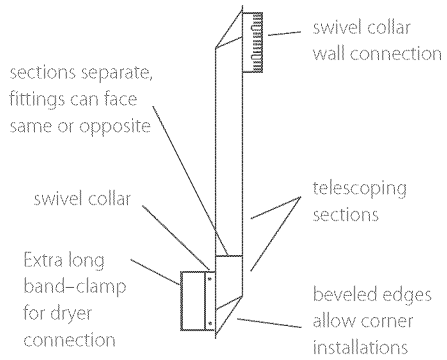
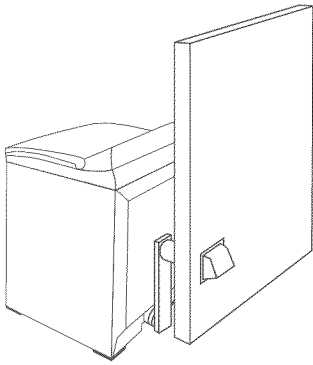

The maximum length using a 2" x 6" (5cm x 15cm) rectangular duct with two elbows and a 2 1/2" (6.3cm) exhaust hood is 8ft (2.4m).

Refer to the venting system kit manufacturers instructions.

Exhaust Venting

WARNING

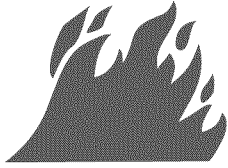

Fire Hazard

- Use heavy metal exhaust duct.
- Do not use a plastic exhaust duct.
- Do not use thin metal foil exhaust duct.
- Failure to do so can result in death or fire.

- 1 Read the exhaust section (page 14 – 18) before installing the exhaust system to determine the maximum allowable exhaust duct length.
Do not use sheet metal screws when assembling ducting. Always use suitable duct tape.
Never use plastic or thin metal foil flexible exhaust material.
- 2 The exhaust outlet is located close to the center of the rear of the dryer. Make sure you join the exhaust duct to the dryer with duct tape only. This will prevent lint and dust from escaping from the dryer and exhaust system.

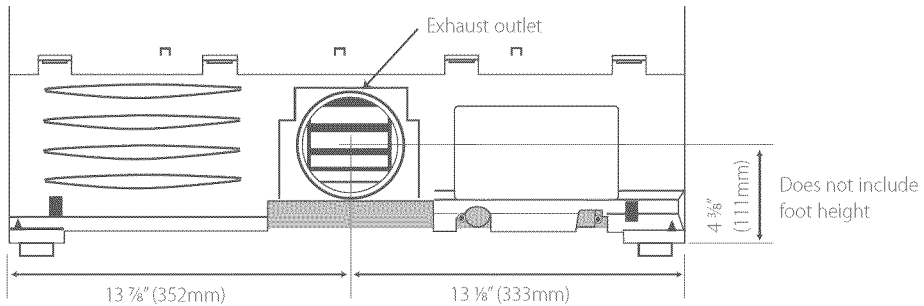

- 3 The exhaust vent can be routed up, down, left, right or straight out the back of the dryer. Refer to diagram.

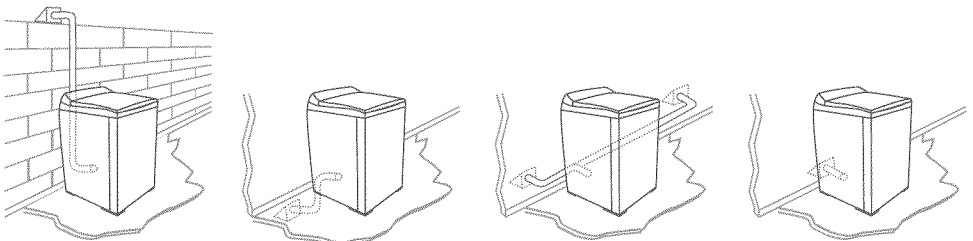

Installation

Parts and literature are packaged inside the dryer drum.

WARNING



Excess Weight Hazard

Use two or more people to move and install the dryer.
Failure to do so can result in back or other injury.

Only remove the packaging at the customer's premises.
This will ensure the appliance arrives in pristine condition and reduces the risk of damage when transporting to the customer's home.

Unpacking

Make sure dryer is in a suitable location for installation.
Consider installing the dryer before the washing machine in a side by side installation, this will allow better access to electrical and exhaust connections.

Remove Packaging

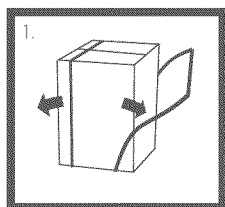

1. Remove straps.

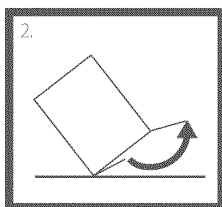

2. Unfold the bottom flaps on the carton.

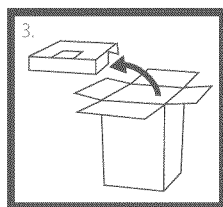

3. Unfold the top flaps on the carton, remove top packer.

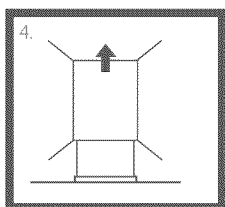

4. Remove the carton by lifting it off the product (do not cut the carton off).

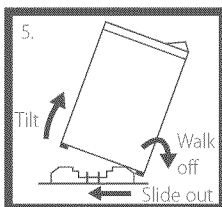

5. Remove the basepacker by tilting the product back and walking the product off.

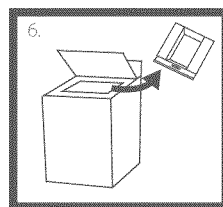

6. Remove the drum packer and the tape from the lint collector bucket in the drum.

Installation

Fitting the Front Feet

Note:

Dryer is usually supplied with feet fitted and protruding the correct distance.

- 1 Tilt the dryer back using a hand trolley and making sure the trolley and dryer are secure.
- 2 Fit a rubber insert to each plastic foot as shown.

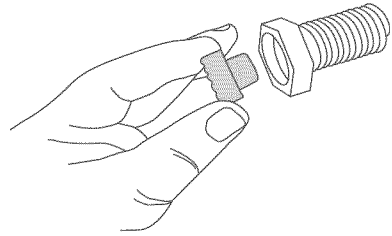
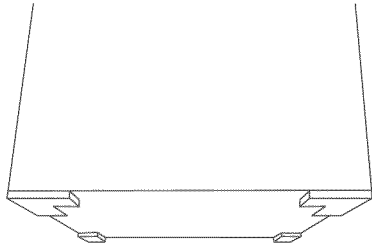

- 3 Screw the feet into the foot retainers on the left hand and right hand sides as shown.

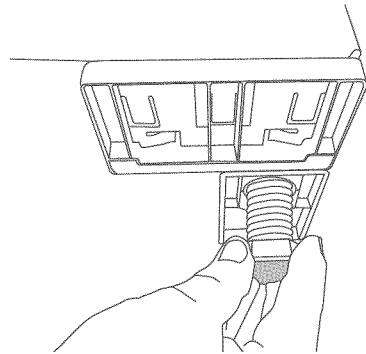
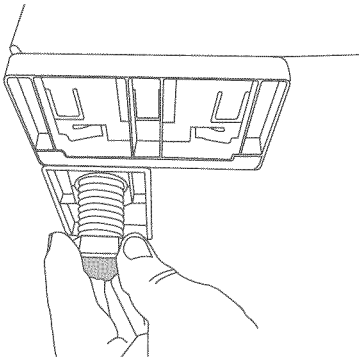

- 4 Screw both feet in so they protrude $\frac{1}{2}$ " (12mm) below the bottom of the wall on the foot retainers.

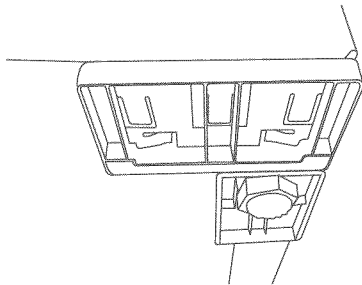
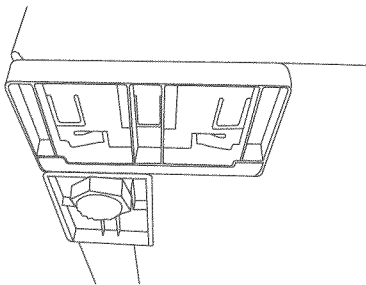

Grounding Instructions for Gas and Electric Dryers

WARNING

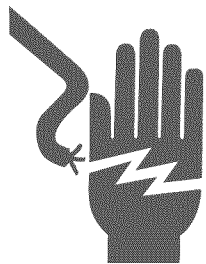

Electrical Shock Hazard

Make sure appliance is wired or plugged into a grounded outlet.

Do not use an adaptor.

Do not use an extension cord.

Failure to follow these instructions can result in death, fire, or electrical shock.

WARNING

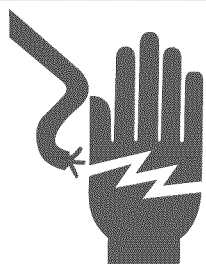

Electrical Shock Hazard

Check with a qualified electrician or serviceperson if you are in doubt as to whether the appliance is properly grounded.

Do not modify the plug if it will not fit the outlet.

Have the proper outlet installed by a qualified electrician.

Failure to follow these instructions can result in death, fire, or electrical shock.

Grounding for a Cord-Connected Appliance

This appliance must be grounded. In the event of malfunction or breakdown, grounding will reduce the risk of electric shock by providing a path of least resistance for electric current. When this appliance is equipped with a cord having an equipment-grounding conductor and a grounding plug, the plug must be plugged into an appropriate outlet that is properly installed and grounded in accordance with all local codes and ordinances, or in their absence, with the National Electrical Code ANSI/NFPA 70, or the Canadian Electrical Code, CSA C22.1. Do not cut or remove the grounding prong from this plug.



WARNING

Improper connection of the equipment-grounding conductor can result in a risk of electric shock. Check with a qualified electrician or service representative if you are in doubt as to whether the appliance is properly grounded.

Refer to pages 23 – 28 for wiring details for electric dryers, including the grounding requirements for a direct wired appliance.

Electrical Requirements for Electric Models Only

WARNING

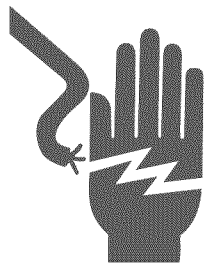

Electric Shock Hazard

Use a new UL approved 30-ampere power cord or direct wire cable.

Use a UL approved strain relief.

Disconnect power before making electrical connections.

Connect neutral wire (white or center wire) to center terminal.

On all four wire installations remove the grounding link and connect the ground wire to the green ground connecting screw.

Connect remaining 2 supply wires to remaining 2 terminals.

Securely tighten all electrical connections.

Failure to do so can result in death, fire, or electrical shock.

Note:

The wiring diagram is located in the control console.

The dryer must be plugged into or connected to an individual branch circuit, do not use an extension cord.

The power supply must be 220/240V or 208V, 60 Hz approved alternating current electrical service. The electrical service requirements can be found on the data label that is located on the splash back. A 30-ampere fuse or circuit breaker is required on each of the lines.

If a power cord is used, the cord must be plugged into a 30-ampere receptacle.

The power cord is NOT provided with U.S. electric model dryers.

This dryer is supplied with the cabinet grounded through the neutral on the terminal block. If the dryer is to be installed in (1) a new branch circuit installation, (2) a mobile home, (3) a recreational vehicle, (4) an area where local codes do not permit grounding through the neutral conductor, the appliance grounding link must be removed and a 4-wire power cord/cable or a separate grounding wire must be used.

Do not reuse a power supply cord/cable from an old dryer. The power cord/cable electric supply wiring must be retained at the dryer cabinet with a suitable UL listed strain relief.

208V Requirements

If your power supply is 208V 60 Hz, a new element kit must be fitted by a qualified electrician or service representative (see Accessories page 9 for kit part number).

Power Supply Cord Requirements for U.S.A for Electric Models Only

- Only a UL listed power-supply cord kit a suitable length for the installation and rated 120/240 V min, 30 A and marked with use for clothes dryers shall be used.
- This shall have ring terminals to connect to the dryer.
- The UL-rated strain relief included with it shall be suitable for a 1 1/8" (28.5mm) hole.

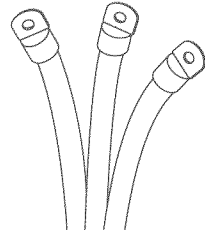

If your outlet looks like this

Choose this power supply cord

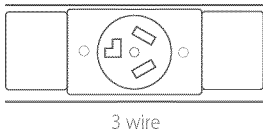

3 wire

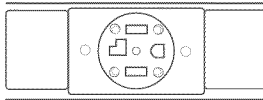
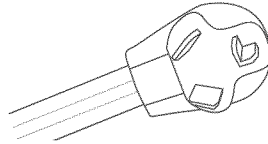

4 wire

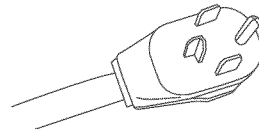

Connecting by Direct Wire

Power supply cable must match power supply (4-wire or 3-wire) and be:

- Flexible armoured or non-metallic sheathed copper cable (with ground wire). All current-carrying wires must be insulated.
- 10 gauge AWG solid copper wire (do not use aluminium wire).
- Suitable length for the installation.
- A UL approved strain relief must be used.

Grounding for a Direct Wired Appliance

This appliance must be connected to a grounded metal permanent wiring system, or an equipment grounding conductor must be run with the circuit conductors and connected to the equipment-grounding terminal on the appliance.

Electrical Connections (Electric Models Only)

Please read **Electrical requirements and grounding instructions** on pages 22 – 23 first.

Electric models of the dryer are manufactured for a 3-wire connection system. The dryer frame is grounded by a link to the neutral conductor on the dryer terminal block. If local codes do not permit grounding through the neutral, the grounding link from the terminal block must be removed and a separate ground wire must be used.

The grounding link on the dryer must be removed for all 4-wire installations including new, remodelled construction, or mobile homes.

These Electrical Connection instructions provide for installing the dryer in the following situations:

- 3-wire connection where local codes **permit** grounding through the neutral.
- 3-wire connection plus separate grounding connector where local codes **do not permit** grounding through the neutral.
- 4-wire connection.

Each of the above connections can be made with an approved power supply cord or by direct wiring. Each connection instruction identifies the appropriate Power Supply Cord and covers requirements for direct wiring.

For 3-Wire Connections by Power Cords

3-wire power supply cord must have three 10 AWG copper wires and match a 3-wire receptacle of NMEA Type10-30R.

For 3-Wire Connections by Direct Wiring

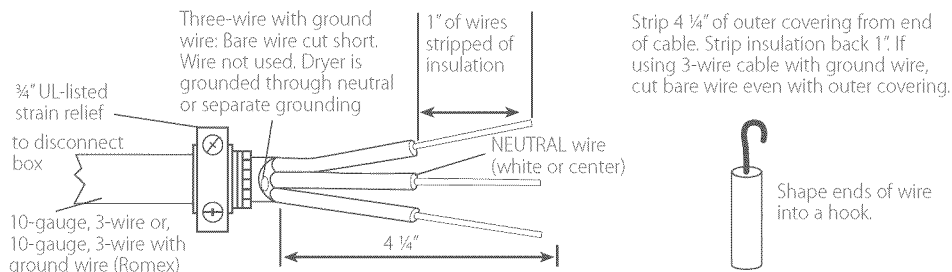

For 4-Wire Connections by Power Cords

4-wire power supply cord must have four 10 AWG copper wires and match a 4-wire receptacle of NMEA Type14-30R. The fourth wire (ground conductor) must be identified by a green cover and the neutral wire by a white cover.

For 4-Wire Connections by Direct Wiring

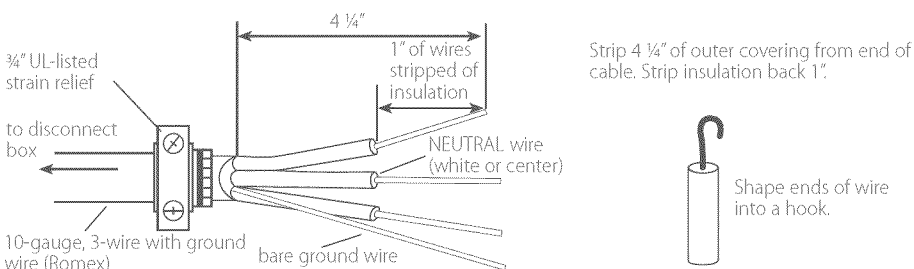

3-Wire Connections

For use where local codes **permit** grounding through the Neutral wire.

Use approved 3-wire Power Supply Cord or a 3-wire Cable for Direct Wiring as described on page 24.

- 1 Remove the terminal block cover plate.
- 2 Insert the power cord with a UL listed strain relief through the hole provided in the cabinet near the terminal block. Do not tighten strain relief screw until wiring connections are complete.

Note: a strain relief must be used.

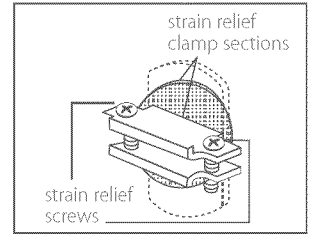
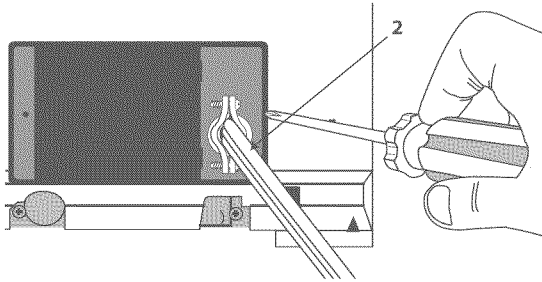

- 3 Loosen or remove the center terminal block screw. Connect the neutral wire (center) of the power supply cord to the center terminal screw of the terminal block. Tighten screw.
- 4 Connect the other wires to the upper and lower terminal block screws marked with the letter L. Tighten screws.

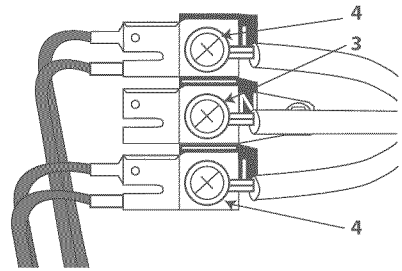
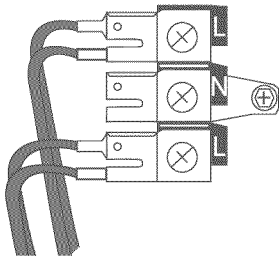

- 5 Refit terminal block cover by inserting the two tabs first on the rear panel of the dryer. Secure cover with securing screw.
- 6 Tighten strain relief screws.

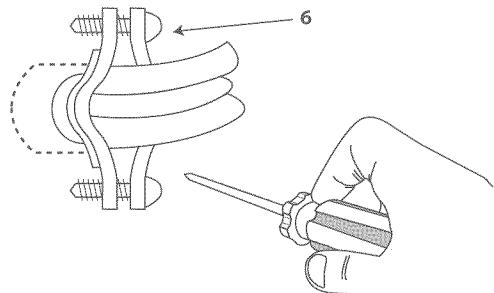
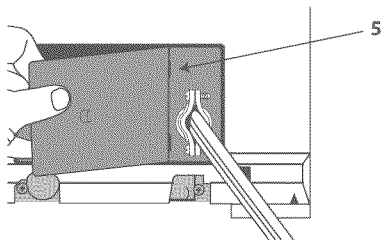

3-Wire Connections plus separate grounding connector

For use where local codes **do not permit grounding through the Neutral wire.**

Use approved 3-wire Power Supply Cord or a 3-wire Cable for Direct Wiring as described on page 25. A separate 10AWG copper grounding wire is required.

- 1 Remove the terminal block cover plate.
- 2 Insert the power supply cable with a UL listed strain relief through the hole provided in the cabinet near the terminal block. Do not tighten strain relief screw until wiring connections are complete.

Note: a strain relief must be used.

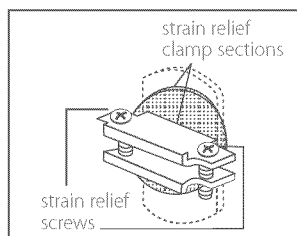
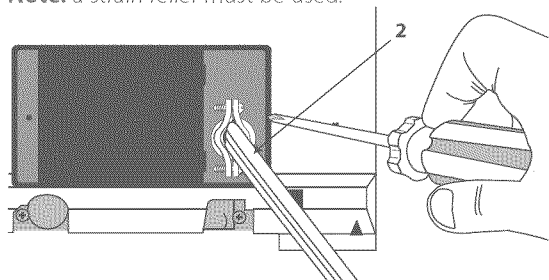

- 3 Remove center terminal block screw.
- 4 Remove appliance ground link by removing the ground connector screw (Green screw).
- 5 Connect a separate copper ground wire (green with yellow stripe) using the ground connector screw (Green screw). Make sure a ring terminal is used when connecting the ground wire and that the wire is firmly secured to an adequate grounding path.

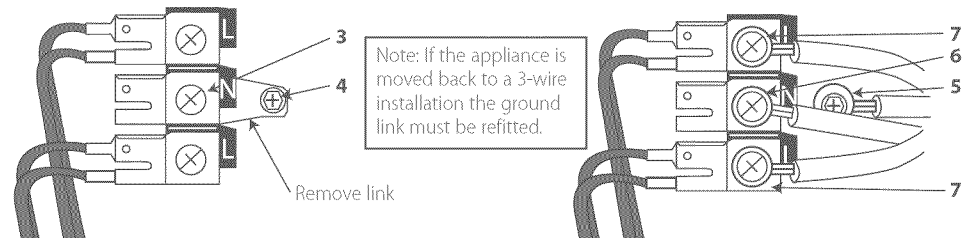

- 6 Connect the neutral wire (center) of the power supply cord to the center terminal screw of the terminal block. Tighten screw.
- 7 Connect the other wires to the upper and lower terminal block screws marked with the letter L. Tighten screws.
- 8 Refit terminal block cover by inserting the two tabs first on the rear panel of the dryer and secure cover with securing screw.
- 9 Tighten strain relief screws.

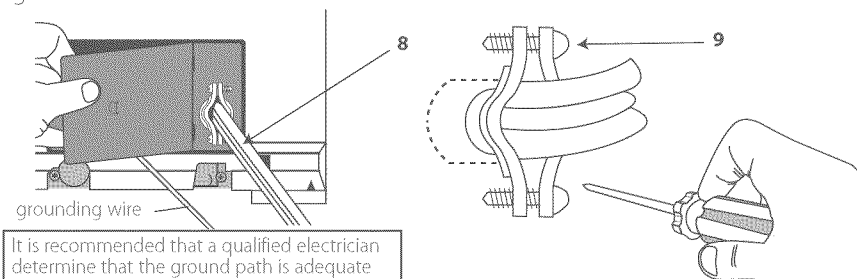

4-Wire Connections

Use approved 4-wire Power Supply Cord or a 4-wire Cable for Direct Wiring as described on page 25.

- 1 Remove the terminal block cover plate.
- 2 Insert the power supply cable with a UL listed strain relief through the hole provided in the cabinet near the terminal block. Do not tighten strain relief screw until wiring connections are complete.

Note: a strain relief must be used.

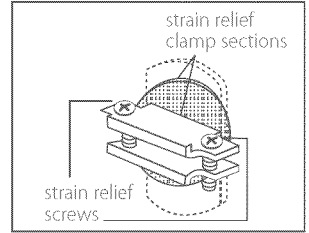
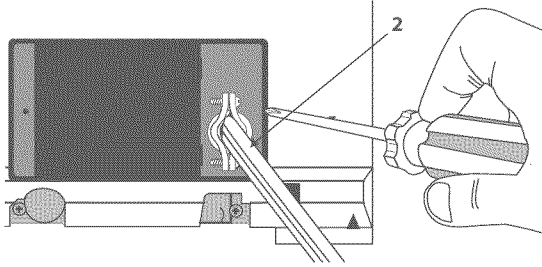

- 3 Remove center terminal block screw.
- 4 Remove appliance ground link by removing the ground connector screw (green screw).

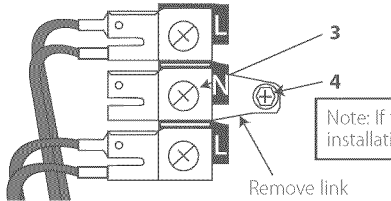

Note: If the appliance is moved back to a 3-wire installation the ground link must be refitted.

- 5 Connect ground wire (green) of the power supply cord to the ground conductor green screw. Tighten screw.
- 6 Connect the neutral wire (white) of the power supply cord to the center terminal screw of the terminal block. Tighten screw.
- 7 Connect the red wire and black wire to the upper and lower terminal block screws marked with the letter L. Tighten screws.

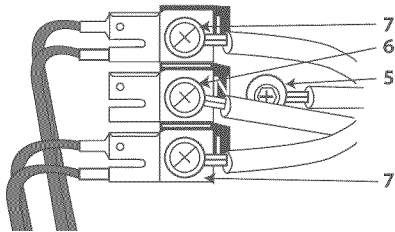

- 8 Refit terminal block cover by inserting the two tabs first on the rear panel of the dryer and secure cover with securing screw.
- 9 Tighten Strain Relief screws.

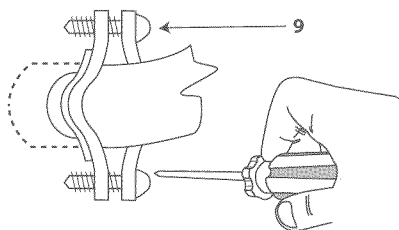
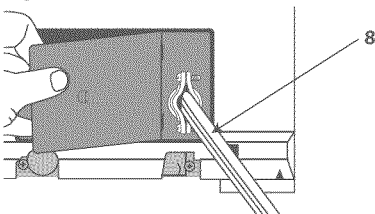

Gas Requirements (Gas Models Only)

The installation must conform with Local Codes, or in the absence of Local Codes, to the National Fuel Gas Code ANSI Z223.1/NFPA 54 or the Canadian Natural Gas and Propane Installation Code, CSA B149.1.

WARNING

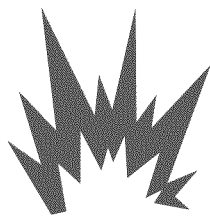

Explosion Hazard

Installations must be performed by a qualified or licensed contractor, plumber, or gasfitter qualified or licensed by the state, province, or region where this appliance is being installed.

Use a new AGA or CSA approved gas supply line.

Install a shut-off valve in an accessible place.

Only use a gas shut-off valve approved for use within the state, province, or region where this appliance is being installed.

Securely tighten all gas connections.

If connecting to LP Gas, have a qualified person make sure gas pressure does not exceed 13" (33 cm) water column.

Failure to follow these instructions can result in death, explosion, or fire.

Gas type

Your dryer must have the correct burner for the type of gas in your home. Burner information is located on the rating plate located on the rear of the console. If this information does not agree with the type of gas available in your home, contact your local Fisher & Paykel supplier or service center.

Natural Gas

This dryer is supplied ready for use with Natural Gas.

It is design certified by UL International for LP (Propane or Butane) Gases with the appropriate conversion.

LP Gas Conversion

If the dryer is to be operated on LP (Liquid Propane or Butane) Gas, the dryer must be converted. To do so, use only the approved Fisher & Paykel conversion kit listed in Accessories on page 9. Do not use with a different gas without consulting the serving gas supplier.

The dryer must be converted for safe and proper performance by qualified service or installation personnel.

Conversion kits for Natural and LP Gas are available from your local Fisher & Paykel Dealer (see Accessories page 9). If other conversions are required, check with your local gas utility for specific information concerning conversion requirements.

Connecting Gas to Your Dryer (Gas Models Only)

Use compound or thread tape appropriate to the gas type that is to be used (Natural or LP Gas), on the male threads of all non-flared connections.

Never use an open flame to test for gas leaks.

This dryer will operate satisfactorily up to altitudes of 6500ft (2000m) above sea level at the BTU rating indicated on the model/serial plate. Burner input adjustments may be required if operating above this elevation.

The dryer must be disconnected from the gas supply system during any pressure testing.

Gas Ignition

This dryer has an automatic ignition system to ignite the burner. There is no pilot flame burning in this dryer.

Connecting to the Gas Supply

- 1 The gas supply line should be $\frac{1}{2}$ inch.
- 2 An individual manual shut-off valve must be installed on the gas supply line within 6ft (1.8m) of the dryer, in accordance with the National Fuel Gas Code ANSI Z223.1/NFPA 54 for the United States or in accordance with the B149.1 Natural Gas and Propane Installation Code for Canada.
- 3 An $\frac{1}{8}$ inch NPT plugged tapping must be installed to allow the gas inlet pressure to be checked. It must be accessible for the test gauge connection and immediately upstream of the gas connection to the dryer.

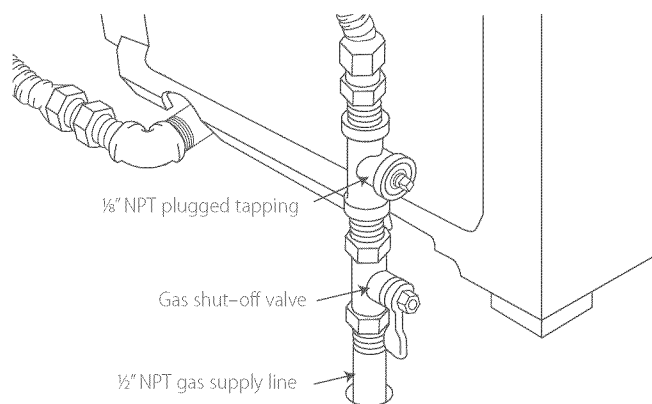

Connecting Gas to Your Dryer (Gas Models Only)

- 4 A listed connector in compliance with ANSI Z21.24/CSA6.10 must be used to connect the dryer to the gas supply.
- 5 If flexible tubing is used, an elbow should be installed on the pipe at the back of the dryer for the flexible tube to be connected to. This will minimize damage to the tube when the dryer is moved back. Use a flexible tubing connection kit that has designed for use on a clothes dryer. This kit should have the unions necessary to join to the ends of the tubing. Be sure to follow all instructions supplied with the kit.
- 6 Copper tubing should not be used for Natural Gas and if used for LP Gas, it must be LP Gas compatible.
- 7 Disconnect and discard old flexible tubing.
- 8 The gas pipe that comes out of the rear of your dryer has on it a $\frac{3}{8}$ " NPT male thread. Remove the protective cap and apply sealing compound or tape to the thread. Thread sealant should be appropriate for the type of gas to be used.

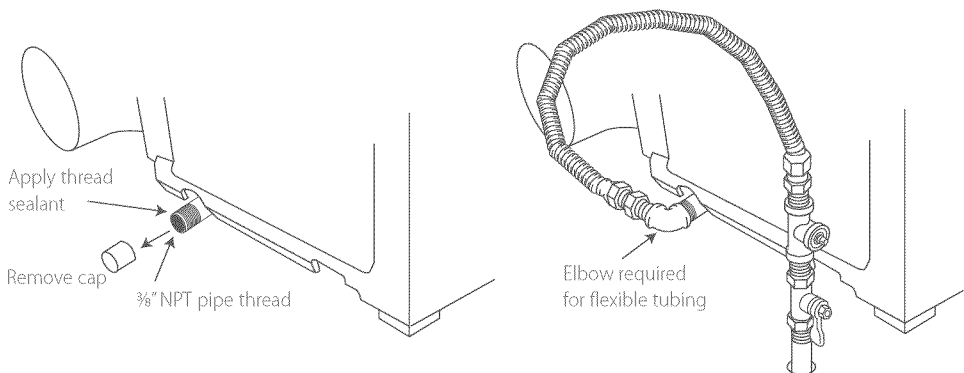

Completing the Connection

- 9 Use wrenches to tighten all joints but do not over tighten.
- 10 Open the gas supply valve and check all joints by brushing on a non-corrosive leak-detecting solution. Bubbling will indicate a leak. If any leaks are found, close the valve immediately and correct the leaks. Retest and repeat until no leaks are found.

Level Machine

Check the dryer is level, and make necessary adjustments to the front levelling feet. The rear levelling feet are self adjusting.

Final Installation Check List

Check that:

- No plastic or flexible metal foil is used in the exhaust ducting.
- Exhaust is rigid ducting or thick wall flexible metal ducting.
- All joints in the ducting are made with duct tape. It must not be connected with screws or other fastening devices which extend into the inside of the duct.
- Ducting is clean and is connected to the dryer.
- Inserts are fitted to the two front feet.
- Dryer is level across the front.

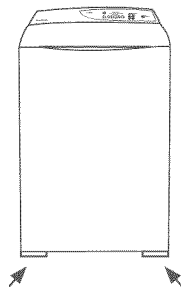

Additionally for Electric Dryer Models Only, Check:

- If installation is 208V, special element kit has been fitted (see page 23).
- Dryer is plugged or directly wired into an approved fitting and is properly grounded.
- Dryer starts, heats, cools and shuts off.
- Customer has been shown how to use the dryer.

Additionally for Gas Dryer Models Only, Check:

- Dryer is plugged into an approved fitting and is properly grounded.
- All fittings in the gas line are tested for leaks.
- Exhaust temperature increases, to confirm ignition has occurred.
 - If ignition does not occur initially, it may be due to air in the gas line or low voltage power supply.
 - The gas regulator valve may fail to open if the power supply falls below 105 Volts.
 - If the gas fails to flow or does not ignite, the dryer will automatically switch off.
- Customer has been shown how to use the dryer.

Note:

All dryers have a drum reversal feature to reduce clothes tangle. Throughout the drying cycle the motor will run for four minutes, then stop and run in the opposite direction for forty seconds before reversing again.

⚠ WARNING!



Electric Shock Hazard

Read and follow the important safety instructions outlined in this User Guide before operating this appliance, pages 6 – 8.

Failure to do so can result in death, electric shock, fire or injury to persons.

Close supervision is necessary if this dryer is used by or near children. Do not allow children to play inside, around or with this dryer or any other appliance.

Features

Smart Loading

The new ergonomic design of this dryer means less bending. Simply move clothes from the washer to the dryer with minimal effort.

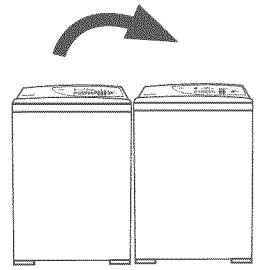

Superior Clothes Care

Superior clothes care is accomplished by an efficient high airflow fan and careful heat control. The *SmartLoad™* dryer provides the right heat for temperature sensitive delicate articles while still efficiently drying more robust regular and denim loads.

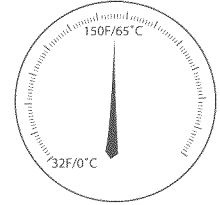

Reverse Action Tumbling

The drum reverses regularly, so your clothes dry more evenly without roping or tangling.

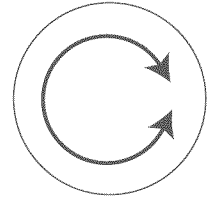

Lint Bucket

The lint filter is automatically scraped clean during the drying cycle and the lint is deposited into the lint bucket. No touching or scraping lint any more. Airflow is more efficient as it is never restricted by a blocked filter.

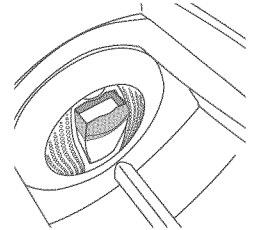

Perfect with the Fisher & Paykel Smart Drive® Washer

The dryer combined with the *Smart Drive®* washer's superior spin performance and quick cycle times will cut laundry turn around time by up to one third, reducing the time you spend doing laundry.

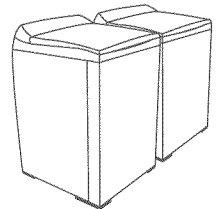

Stainless Steel Drum

Being stainless steel, this drum is not only more hygienic, it's also more resilient and easier to keep looking good.

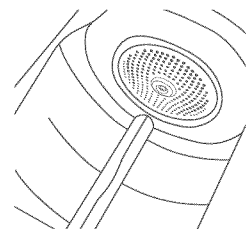

Operating Instructions Control Panel

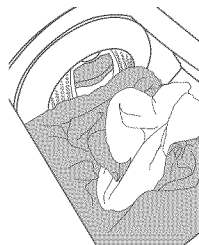

A. Sorting

- Sort clothes of similar types and loads that take similar times to dry. (Refer to Sorting page 37).

B. Loading

- Load clothes no higher than the transparent section of the lint bucket. (Refer to Loading page 37).

C. Lint Bucket

- Check to see if the lint bucket needs emptying. Empty before the lint reaches the top of the transparent section (refer to Lint Bucket page 38).

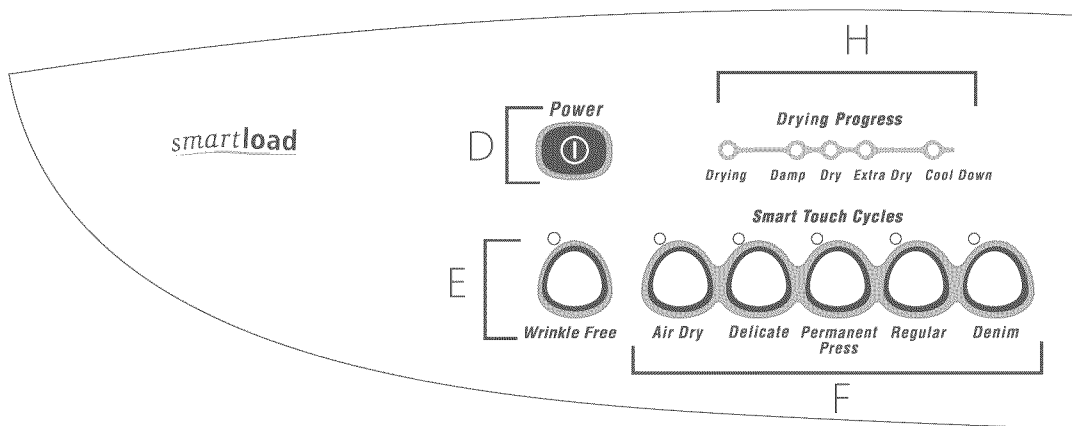
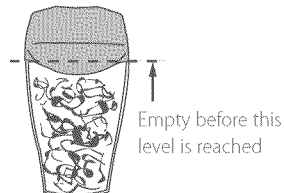

D. Press Power

E. Wrinkle Free

- This option reduces the likelihood of wrinkles forming in garments when the drying cycle has finished by periodically tumbling the clothes without heat. This feature can be used in conjunction with any cycle. (Refer to page 40).

F. Smart Touch Cycles

- Choose the Smart Touch cycle that most represents the items in your load. Your dryer defaults to the **REGULAR** cycle, to change it press any of the other cycle buttons.

Control Panel

G. Auto Sensing

There are five automatic dryness levels: **DAMP**, **DAMP/DRY**, **DRY**, **DRY/EXTRA DRY** AND **EXTRA DRY**. These five settings dry your clothes to different degrees depending on the level of dryness you would like.

EXTRA DRY – This is mainly for items that you want to store (i.e. place in a drawer, cupboard or wardrobe). By using this setting you eliminate the possibility of ‘musty smells’ that commonly occur when items are stored in a damp state.

DRY – Dries clothes to a level where they are considered ‘dry’, so garments can be worn immediately.

DAMP – Dries the clothes to a level where they are considered ‘moist’. It is designed for delicate, light-weight fabrics and articles of clothing which you want to iron-dry.

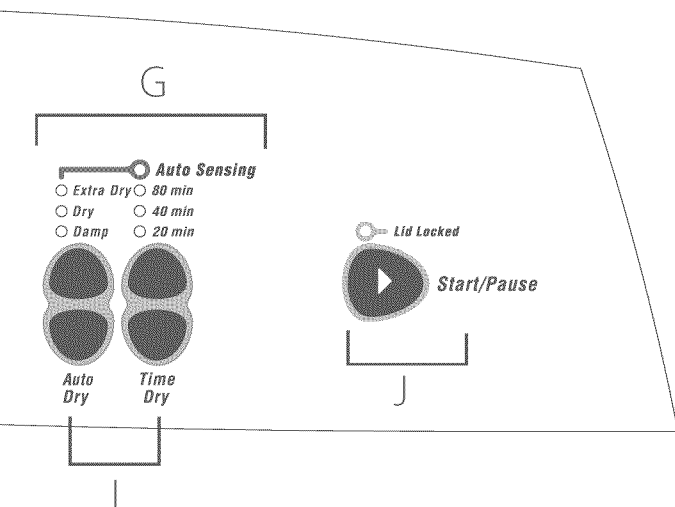

H. Drying Progress

- These lights show the drying progress so you can see at a glance where the dryer is at.

I. Time Dry

- **SmartLoad™** has three timed cycles. These cycles have set drying times of either 20, 40 or 80 minutes and include a **COOL DOWN** function. If selected, your dryer will dry for the specified period of time.

J. Start

- Press **START/PAUSE** to start your machine.

! WARNING

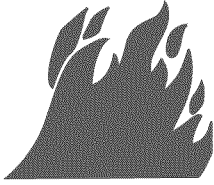

Fire Hazard

Only dry fabrics that have been washed with water.
 Do not use heat to dry articles containing foam rubber or similarly textured rubber-like materials. Dry on the Air Dry cycle.
 A clothes dryer produces combustible lint and must be exhausted outdoors. Take care to prevent the accumulation of lint around the exhaust opening and in the surrounding area.
 Failure to follow these instructions can result in death or personal injury.

! WARNING

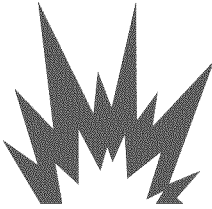

Explosion Hazard

Keep flammable materials and vapors, such as gasoline, away from dryer.
 No washer can completely remove oil.
 Do not dry anything that has ever had gasoline, oil or anything flammable on it (including cooking oils).
 Failure to follow these instructions can result in death or personal injury.

1 Press POWER

2 Select Cycle

3 Choose how dry you want your clothes

4 Press START

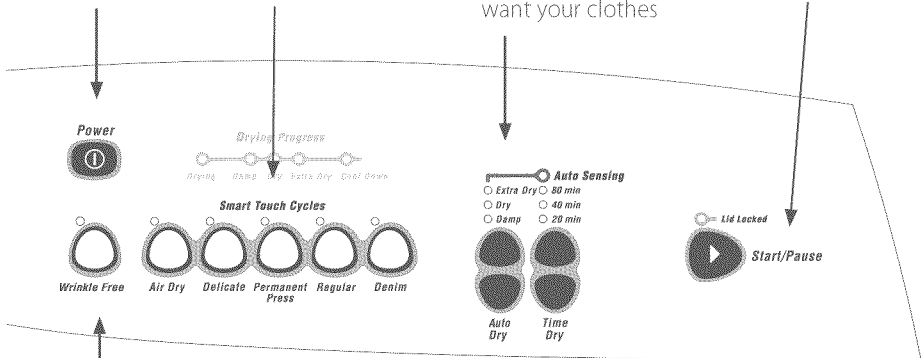

If you want to reduce wrinkles press **WRINKLE FREE**

Using Your Dryer

Check the care labels inside the garments to determine whether the garment manufacturer recommends tumble-drying (see care label section).

1. Sorting

It is best that you sort your garments before placing them into the dryer. Sort into loads of similar types, and loads that take similar times to dry.

Heavier items (e.g. towels, t-shirts and flannel sheets) are best dried separately from lightweight items (e.g. synthetics, poly-cotton sheets and shirts). This prevents the possibility of some items becoming over-dried whilst others are still damp. It will also help to extend the life of your clothing and linen.

Drying your clothes as soon as the washer has finished will decrease the chance of wrinkles and the chance of dye transfer from colored items to white items.

We recommend that articles of clothing with screen-printing are turned inside out to ensure the screen-printing does not stick to the drum. Garments with hooks or zippers need to be fastened and where possible turned inside out. Place undergarments in a net bag to provide protection from other items in the load.

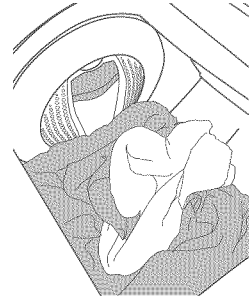

2. Loading

Garments need to be loaded properly to reduce the likelihood of them wrinkling and to ensure the load is dried evenly. Make sure there is ample room for the garments to tumble freely while drying. Load in terms of the space the garments take up when dry, rather than when they are wet.

The general rule is one wash load = one dryer load.

Only load the dryer up to the top of the transparent section of the lint bucket. Loading any higher may result in uneven drying, tangling, wrinkling and the dryer becoming overloaded.

It is a good idea to dry 'permanent press' type garments together in a separate cycle with the **WRINKLE FREE** option turned on. This will help reduce wrinkles and the need for ironing.

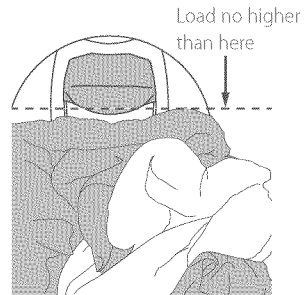
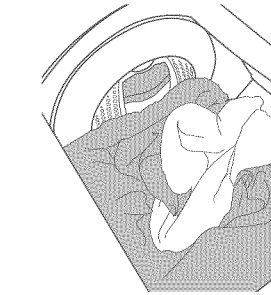

Using Your Dryer

3. Lint Bucket

The *SmartLoad™* dryer's lint removal system is unique. Unlike other dryers, the *SmartLoad™* dryer automatically removes the lint for you – all you have to do is tip the lint out!

The lint filter is hidden behind the lint bucket. As the air passes through this filter the lint is caught on the fine mesh. Once the lint is about 1/8" (2mm) thick it comes into contact with a scraper which deposits it into the bucket. This process is automatically performed every time lint builds up on the filter.

Apart from the benefit of not having to scrape the lint after every cycle, it also means the drying efficiency is not affected by lint build-up during the drying cycle.

The lint bucket is located inside the dryer on the left-hand side. You can remove it by gently pulling the handle and lifting outwards. It slots easily back into place.

This lint bucket does not need to be cleaned as regularly as other dryer's lint filters. The lint bucket only needs to be emptied before the lint reaches the top of the transparent section.

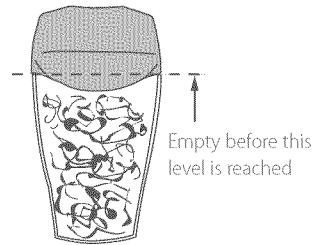
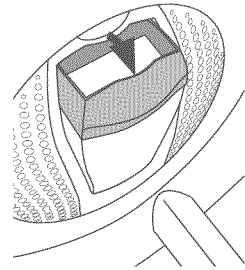

It is important that you run your dryer with the lint bucket in place at all times.

4. Power

To turn on your dryer, press the **POWER** button located at the top left-hand corner of the control panel.



Using Your Dryer

5. Selecting a Cycle

Your dryer has a number of SMART TOUCH CYCLES that can be used to dry different types of garments:

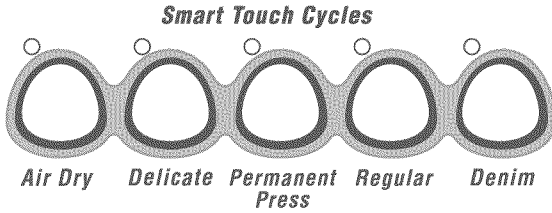

Select a drying cycle that matches the type of load you are drying. Different fabrics have different drying requirements, so it is important to choose the cycle that best describes the load. If your load contains mainly delicate items it is best you select the **DELICATE** cycle.

Always follow manufacturer's care label instructions when drying.

If you are unsure of the temperature to select for a load, it's best to select a lower heat rather than a higher heat, eg the **DELICATE** or **PERMANENT PRESS** cycle instead of the **REGULAR** cycle.

AIR DRY – For items requiring drying without heat. Perfect for airing clothes or to freshen up garments that have been packed in a suitcase or drawer.

DELICATE – For heat sensitive items, this cycle uses a low heat. Use this setting when care labels recommend low heat settings or for garments with a synthetic fiber content, where overheating could cause damage to fibers.

PERMANENT PRESS – For drying lightweight fabrics. A medium heat is used to reduce wrinkles. Ideal for lightweight cottons, casuals and items labelled "tumble dry with a medium heat". This cycle automatically selects the **WRINKLE FREE** option to reduce wrinkles.

REGULAR – For drying general cottons such as sheets, sweats and knits. This cycle uses a high heat to dry clothes quickly. Suitable for garments labelled "tumble dry".

DENIM – For drying denims or similar heavyweight items like jeans and thick towels which are bulky or have thick seams. The **DENIM** Cycle has been tailored to adequately dry these items.

Using Your Dryer

Wrinkle Free

Minimizes the likelihood of wrinkles forming in clothes if you are not able to unload the dryer straight away.

WRINKLE FREE rotates the drum periodically after the cycle has finished, tumbling and blowing cool air through the clothes to ensure they remain wrinkle free. **WRINKLE FREE** uses very little power and will continue for up to 24hrs or until the dryer is turned off. After completing each tumble *SmartLoad™* will give an 'End of Cycle' beep to remind you that the load is dry and can be removed.

To stop **WRINKLE FREE** press either **POWER** or **START/PAUSE**. *SmartLoad™* will open the drum door and unlock the lid so you can remove your clothes.

WRINKLE FREE can be selected on any cycle and can be turned **ON** or **OFF** at any time during the cycle. This option is automatically selected on the Permanent Press cycle.

While **WRINKLE FREE** is in motion, only the **WRINKLE FREE** light, the **CYCLE** light and the **LID LOCKED** light will be lit.

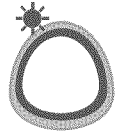

Wrinkle Free

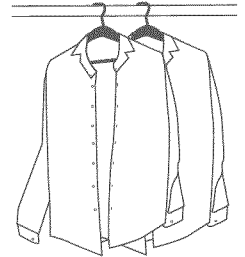

6. Selecting the Dryness Level

The desired dryness level can be altered. There are five dryness levels to choose between:

- **EXTRA DRY**
- **DRY/EXTRA DRY**
- **DRY**
- **DAMP/DRY**
- **DAMP**

Refer to page 35 for Dryness Level descriptions.

The dryer defaults to the **DRY** setting. To change this, press either the up or down arrow to move to your desired dryness level. If you choose the **DAMP/DRY** or **DRY/EXTRA DRY** setting, two lights will be displayed.

At the end of the cycle, if the clothes are still damp or are too dry, next time just adjust the dryness level on the touch pad to meet your personal preferences.

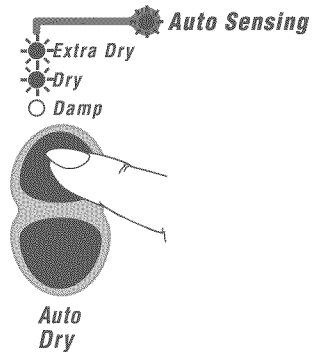

Using Your Dryer

7. Selecting the Drying Process

There are two ways in which your dryer is able to dry clothes; by using **AUTO SENSING** or by using **TIME DRY**.

AUTO SENSING

When **AUTO SENSING** is selected *SmartLoad™* automatically senses the dryness level of the load and turns off when the clothes are dry. *SmartLoad™*'s internal computer measures the moisture content of the load using metal sensing bars and together with a temperature sensor determine when the clothes have reached the selected dryness level (Refer to page 40 – Selecting the Dryness Level).

For optimum clothes care, match the cycle to the load. **AUTO SENSING** often provides the best results and leads to lower energy costs than **TIME DRY**.

TIME DRY

There are three timed cycles. You can choose between 20, 40 and 80 minutes. A **COOL DOWN** period of 10 minutes is included in the 80-minute and 40-minute cycle. The 20-minute cycle has a 5-minute **COOL DOWN** period.

To select a timed cycle, press the down arrow on the **TIME DRY** selection. The **AUTO SENSING** light will switch off. Now select the time you want your dryer to run for.

Throughout the cycle, the progress lights above the **SMART TOUCH CYCLE** buttons signal your load's progress. This is an indication of how dry your load is. The load will continue drying until the time you have set has elapsed.

During **TIME DRY**, the dryer does not sense when the clothes are dry. This may cause over-drying. We recommend that you dry your clothes for a slightly shorter time than you think they need, or check on them regularly (to avoid over-drying).

8. Beginning Drying Cycle

Once you have chosen all your desired settings, press **START/PAUSE** (located on the right-hand side of the control panel).

You will hear a few new sounds that you may not have heard from your previous dryer. These noises are normal and are related to *SmartLoad™* locking the lid and closing the drum door.

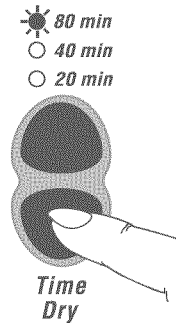
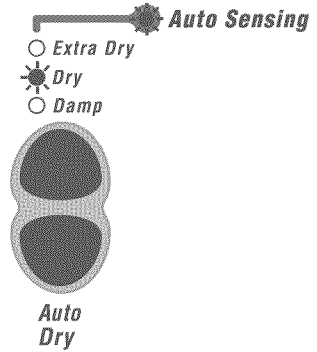

Using Your Dryer

9. Stopping Your Dryer

Your *SmartLoad™* dryer can be stopped during any stage of the drying process, to allow you to check on your load or add/remove clothes.

To do this, press **START/PAUSE**. There will be a slight delay as the drum slows down and stops in the open position (approximately 15 seconds). During the opening sequence, the **LID LOCKED** light will flash, once the drum is stationary the light will be extinguished, you can then open the lid.



Note:

If the cycle is interrupted before it progresses into **COOL DOWN**, parts of the drum may be hot.

To start your dryer again, press **START/PAUSE**.

10. Changing Cycles During Operation

If you wish to change the drying cycle you have chosen after the machine has already begun drying, press your new cycle selection on the control panel. If the progress lights have begun to advance through the cycle, you will need to turn the dryer off and start afresh.

11. Fabric Softener Sheets

If you want to use fabric softener sheets, you must ensure that they are labelled "dryer safe". Always follow the instructions on the packaging. Do not place them in a dryer with warm clothes as there is a chance the fabric softener may stain clothes. Only use a softener sheet once, then discard it.

12. Beeps

At the end of the cycle, the dryer will beep to let you know that the load is finished. The drum will automatically come to rest in the open position, allowing you to open the lid and remove your load.

13. Finishing your Cycle Early

Normally *SmartLoad™* will advance through the progress lights as it dries and will switch off once it has completed **COOL DOWN**.

If you wish to finish your drying cycle early you can press **AIR DRY** to advance it to this **COOL DOWN** mode.

The **COOL DOWN** mode means the elements will switch off and the clothes are tumbled without heat. When *SmartLoad™* senses the clothes are cool it will automatically shutdown (this takes 2 – 10 minutes depending on the size of your load).



Note:

The **COOL DOWN** mode is only activated if your dryer has progressed past the **DRYING** progress light. If the **DRYING** progress light is still glowing and you press **AIR DRY** your dryer will switch to the **AIR DRY** cycle and will dry for 80 minutes (the default **AIR DRY** setting). You can stop your dryer at any stage by pressing **START/PAUSE**.

Drying Progress Lights

Drying Progress Lights

There are five progress lights located above the **SMART TOUCH CYCLES** that let you monitor the progress of your load so you can tell at a glance where the dryer is up to.

When the dryer is started, the **DRYING** light appears, letting you know that the dryer is in the process of drying the load.



When the dryer senses that the load is beginning to dry, the **DAMP** light will glow (the **DRYING** light will still be on). Once the **DAMP** level is reached, the **DRYING** light will be turned off, leaving only the **DAMP** light on. At this stage, the dryer will sound a couple of beeps to indicate that delicate, light-weight fabrics and garments can be removed from the dryer.



When the dryer senses that load is **DAMP/DRY**, both the **DAMP** and **DRY** lights will be on.



The **DAMP** light will be extinguished when the load is dry, leaving only the **DRY** light on. If you have chosen the **DRY** setting the dryer will progress to **COOL DOWN**.



If you have selected a drier setting other than the default setting (ie. **DRY**) the lights will continue through the remaining progress lights. Refer to page 40.



The **COOL DOWN** light will come on when *SmartLoad™* is in the process of cooling down the dry load. This is where the load is tumbled with no heat, decreasing the need for ironing. **COOL DOWN** will continue until the dryer senses the clothes have been cooled down sufficiently. The exception is **TIME DRY** which has a fixed **COOL DOWN** period.



Lid Lock

Your *SmartLoad™* dryer locks its lid at the start of the drying cycle, providing added safety for you and your family while it is operating. This lock ensures the lid cannot be opened while the drum is rotating.

The **LID LOCKED** light (above the **START/PAUSE** button) comes on when the lid is locked.

If the **LID LOCKED** light is flashing, the **LID LOCK** is in the process of locking or unlocking. During this stage, the lid still cannot be lifted.

The lid must be closed before the drying cycle can start. If **START/PAUSE** is pressed with the lid open, the machine will beep, to signal that the lid needs to be closed. Once the lid has been closed and **START/PAUSE** is pressed, the **LID LOCK** will be activated and the drying cycle will begin.

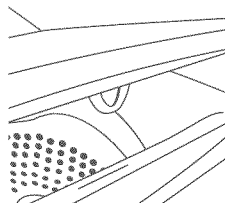

Power Failure

If the power is cut while your *SmartLoad™* dryer is operating, the lid will be unlocked. In some circumstances the drum door may not be automatically opened. If this occurs it is best if the dryer is not interfered with. When the power is restored the dryer will automatically resume operating. However if it does not automatically open, first close the lid and start the dryer in the usual manner, after 5 seconds press **START/PAUSE**. This will cause *SmartLoad™* to open correctly with the lid unlocked.

If it is absolutely necessary to remove some items before power is restored follow the steps below:



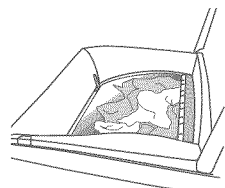
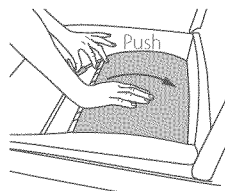
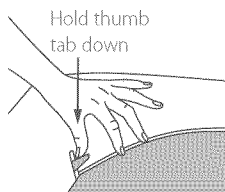

- 1 Ensure the dryer is disconnected from the power supply.
- 2 Open the lid (this will already be unlocked).
- 3 On the left hand side of the dryer there is a thumb tab that appears when the drum is closed. Press the thumb tab, while rotating the drum by hand away from you (push the drum towards the back of the dryer).
- 4 Hold the thumb tab down until the drum starts opening.
- 5 Keep rotating the drum until it is fully open and it comes to a stop.
- 6 Now you can remove items from the dryer drum.
- 7 Close the lid once you have removed desired items.
- 8 Re-connect the power supply to your dryer.











The drum door will automatically close and the dryer will resume normal operation when power is restored.

Care Labels

Below is a selection of care label symbols that garment manufacturers use to show how their garments should be dried. We've converted these symbols into the cycles and heat settings that we recommend you use in the *SmartLoad™* dryer. By following our recommendations, you can ensure that your clothes will retain their appearance over time.

Tumble Dry Symbols	Normal 	Permanent Press 	Delicate 	Do not Tumble Dry 
Cycle We Recommend	DENIM or REGULAR	PERMANENT PRESS	DELICATE	AIR DRY with Drying Rack

Tumble Dry Symbols	Any Heat 	High 	Medium 	Low 	No Heat 
Cycle We Recommend	Any Cycle	DENIM or REGULAR	PERMANENT PRESS	DELICATE	AIR DRY

Additional Drying Instructions	Hang to Dry 	Drip Dry 	Dry in Shade 	Dry Flat 
Cycle We Recommend	Do not place articles with these symbols in the dryer.			

Drying Special Items

There are some articles that need to be dried in a special way. Before you dry any item that is not described in *SmartLoad™*'s cycles (page 39), refer to the table below. Always remember to follow the manufacturer's instructions.

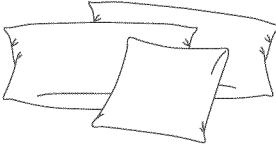
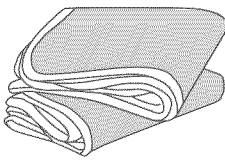
Item	Special Instructions
<p data-bbox="90 296 381 336">Pillows</p> 	<p data-bbox="381 296 1056 336">Check the care label – can the pillow be dried in the dryer?</p> <p data-bbox="381 336 1056 376">Do not dry foam rubber pillows.</p> <p data-bbox="381 376 1056 448">It is important that before placing a pillow in the dryer you check for weak seams where feathers or fillings could escape.</p> <p data-bbox="381 448 1056 488">You can dry one average sized pillow at a time.</p> <p data-bbox="381 488 1056 528">Choose the DELICATE cycle and set 20 minutes drying time.</p> <p data-bbox="381 528 1056 568">Check the pillow at regular intervals.</p> <p data-bbox="381 568 1056 639">Note: It is important to completely dry the pillow to prevent mildew from forming.</p>
<p data-bbox="90 639 381 679">Blankets</p> 	<p data-bbox="381 639 1056 679">Check the care label – can the blanket be dried in the dryer?</p> <p data-bbox="381 679 1056 751">Include 4 – 5 medium sized towels along with the blanket for cushioning. This will help stop shrinkage from over tumbling.</p> <p data-bbox="381 751 1056 847">If you are drying more than one blanket, ensure they do not sit higher than the top of the lint bucket, otherwise there will not be enough space for them to tumble.</p> <p data-bbox="381 847 1056 887">Choose the DELICATE cycle and set 20 minutes drying time.</p> <p data-bbox="381 887 1056 983">On completion, remove the blanket, shake and, if needed, stretch the blanket back to its original shape. Place it back in the dryer and repeat until the blanket is dry.</p> <p data-bbox="381 983 1056 1062">Note: It is important to completely dry the blanket to prevent mildew from forming.</p>
<p data-bbox="90 1062 381 1126">Plastic Foam rubber Rubber-backed products</p>	<p data-bbox="381 1062 1056 1126">Do not dry products containing foam rubber, plastic or rubber on any cycle other than AIR DRY.</p> <p data-bbox="381 1126 1056 1198">Drying these types of garments on any cycle other than AIR DRY is a FIRE RISK.</p>

Drying Special Items

Item	Special Instructions
Extra large items (including bedspreads and comforters)	<p>Check the care label – can item be dried in the dryer?</p> <p>Use a low heat setting. We recommend the DELICATE cycle and AUTO SENSING.</p> <p>Select the DRY/EXTRA DRY Dryness Level.</p> <p>It is best to check the item halfway through the cycle to ensure even drying.</p> <p>If the item contains feathers add a heavy item (e.g a wet towel tied in a knot) to the load to help fluff the comforter.</p> <p>Ensure the load does not sit higher than the top of the lint bucket before starting the cycle.</p>
"In Dryer" Dry-Cleaning Products	<p>Ensure the dry-cleaning product is recommended for use in a domestic dryer.</p> <p>Follow the manufacturers instructions for how to prepare the load.</p> <p>Set the dryer to the PERMANENT PRESS cycle, this cycle uses a medium heat. Select TIME DRY for 40 minutes.</p> <p>At the end of the cycle remove the dry-cleaning product from the machine and continue to follow the dry-cleaning product's instructions.</p>

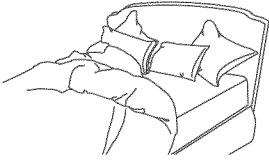

Drying Times

Drying times can be affected by a number of factors including:

- The cycle chosen
- Load size
- Size of the items
- Type of fabric
- Load wetness
- Location of the dryer
- Venting method
- Heat used (electric, natural gas or LP gas)
- Condition of exhaust ducts

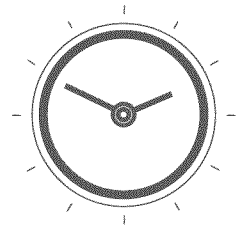

Cleaning

Clean your dryer with a soft damp cloth and wipe dry. Do not use scouring cleaners as they can damage the paint and plastic surfaces.

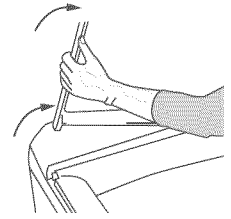

Removing the Lid

You can remove the lid for cleaning. Open the lid fully, hold one side with one hand and tap the other side with an upwards motion. To replace the lid, hold the lid vertically and align both hinges before clicking back into place.

Pre-Treatment Sprays

Do not use pre-treatment sprays or liquids on or near your dryer as they can damage your machine's control panel as well as any of its plastic parts. Damage to your dryer caused by pre-treatment products will not be covered by your warranty.

Stains

If stains appear inside the drum of your machine, mix a detergent and water paste (or use a non-flammable liquid cleaner) and wipe over the stain with a soft cloth. Then tumble old towels for 20 – 40 minutes on the **AIR DRY** setting to remove all traces of the cleaner.

Lint Bucket

The lint bucket will need to be emptied before the lint reaches the top of the transparent section. A lint bucket that is not full ensures your clothes will remain lint-free and your dryer will operate at maximum efficiency.

Venting

Regularly inspect the outdoor exhaust opening. Remove any accumulated lint from this area and any surrounding areas.

Ensure that the area around the dryer is kept clear and free from combustible materials, gasoline and other flammable vapors or liquids. Ensure also that the dryer area is kept clear and free from items that would obstruct the flow of combustion and ventilation air.

If Your Dryer Beeps For Help

Your *SmartLoad™* dryer is capable of diagnosing its own troubles. If your dryer gives a musical series of beeps every 5 seconds, it's telling you that it has a warning which you might be able to solve using the checklist below. (It's the same sound *SmartLoad™* makes when you plug it in).

Look at the pattern of lights on the panel to find out what problem your dryer is experiencing.

If you are unable to solve the problem from the checklist below call for service.

Machine is beeping and... **AUTO SENSING** light is flashing (your dryer is still running)

This light indicates there is an airflow restriction and your clothes will take longer to dry.

Possible reasons for the airflow restriction could include:

Your lint bucket is too full. Remove the lint from the lint bucket, then run the dryer on any cycle for a few minutes with no load to remove any lint still trapped in the dryer. Empty the lint bucket again.

Check the exhaust system. The ducting could be restricted, squashed or blocked. Is the piping bent, kinked or clogged? Does it need to be cleaned?

Machine is beeping and... **LID LOCKED** light is flashing

Close the lid and press **START/PAUSE**.

If the lid is already closed, open the lid and close it again, then press **START/PAUSE**.

Disconnect from the power (either by unplugging the dryer or turning off the circuit breaker that supplies it). Wait 10 seconds, reconnect and try turning it on again.

Machine is beeping and... **TIME DRY 20 MINUTE** light is flashing

The machine is unable to close the drum due to clothes interfering with the closing mechanism. Remove any articles that are interfering with the drum door and dry these in the next load.

Is your load higher than the top of the lint bucket? Remove some articles and dry these in the next load.

If your dryer is continually beeping and one or more of the progress lights is flashing, a fault has occurred which requires repair from your Service Agent.

Pressing the **POWER** button once will stop the beeping but will still display the fault code. We recommend leaving the machine in this mode as the fault code will enable the service person to quickly identify the cause of the problem.

Trouble Shooting

Pressing **POWER** does not turn the dryer on

Is the electrical cord plugged in? If not plug the cord in.

If there is a switch, is it switched on?

Could your household power supply be at fault? (If your plug is suitable, try plugging another electrical appliance into the same outlet).

Check your house circuit breakers and fuses. If they are at fault contact an electrician.

Dryer does not heat

Is the dryer set to the **AIR DRY** cycle?

Is the gas turned on? (Gas/LPG dryers only)

Has the dryer progressed to **COOL DOWN**. (Check the Progress lights).

If the problem persists call for service.

Clothes are still wet/damp

Is the dryer set on **DAMP**?

Try selecting a higher dryness level.

Is the drum warm? If not, is the dryer set to **AIR DRY**?

If you have a gas dryer, is the gas turned on? Is your LPG bottle empty?

Try drying similar weight clothes together.

If the problem persists call for service.

Pressing **START/PAUSE** does not start the dryer

Is the lid open? Shut the lid and press **START/PAUSE**.

Is there a fault displayed on the panel? Refer to page 42 – If Your Dryer Beeps For Help.

Dryer is taking a long time to dry

Is the lint bucket full? If so empty it to improve performance.

Is the airflow system free from obstruction?

Has the dryer been vented correctly? Is the venting distance too great?

If you have a gas dryer, is the gas turned on? Is your LPG bottle empty?

Is the machine over-loaded?

Have heavyweight items been separated from lightweight items?

Are the clothes very wet when they are removed from the washing machine? Increase your washer's spin speed.

Are you using the **AIR DRY** cycle?

Is your dryer on **DELICATE**?

Dryer keeps stopping and starting

Your dryer has a reverse action tumble. When it changes direction it will pause momentarily and will start again in the opposite direction, this is normal.

Has **WRINKLE FREE** been turned on?

Trouble Shooting

Linting Problem

Is the lint bucket full? When lint reaches the top of the transparent section of the bucket it needs emptying.

Have you separated lint shedding garments (eg towels) from lint receiving garments (eg synthetics).

Have you checked your pockets for tissues or other items that could have been left in them?

Have you over-loaded your dryer? Over-loading can result in linting problems due to reduced airflow and lint not being able to collect on the filter.

Have you over-dried your load? Over-drying can cause lint-attracting static electricity. Try a lower dryness setting or use **AUTO-SENSING** instead of **TIME DRY**.

Is the lint bucket in place?

Static problems

Have your clothes been over-dried? Reduce the dryness setting.

Have you used fabric softener? Place fabric softener sheets in the dryer.

Items shrinking

Has the load been over-dried? Choose a lower dryness setting.

Is tumble drying recommended? Check care labels inside garments.

If you selected **TIME DRY** - did you set it to dry for too long?

Has the correct temperature been used to dry the garment? Check the care label.

Loads are wrinkled

Does the load sit higher than the lint bucket? Your dryer is over-loaded, decrease the load size.

Did you remove your clothes as soon as the dryer was finished? Use the **WRINKLE FREE** option, if you cannot return to the dryer in time.

Have your clothes been over-dried? Select a lower dryness level. Check your garments care labels.

Drum door will not open

Refer to page 44 – Power Failure for more information, or contact your Fisher & Paykel Authorized Service Agent.

Lid will not open

Is the **WRINKLE FREE** button selected? Press **START/PAUSE** to open the lid.

Dryer has stopped during the cycle with the white **WRINKLE FREE** light illuminated and the LCD screen blank.

Your dryer may be experiencing a low voltage supply. Without enough electricity it cannot function. Once the line voltage returns to normal the dryer will recommence the interrupted cycle. If the problem persists call for service.

Limited Warranty

When you purchase any new Fisher & Paykel whiteware product for personal or consumer use you automatically receive a one year limited warranty covering parts and labor for servicing within the 48 mainland United States, Hawaii, Washington DC and Canada. In Alaska the limited warranty is the same except that you must pay to ship the product to the service shop or the service technician's travel to your home. Products for use in Canada must be purchased through the Canadian distribution channel to ensure regulatory compliance.

If the product is installed in a motor vehicle, boat or similar mobile facility, you receive the same one year limited warranty, but you must bring the vehicle, boat or mobile facility containing the product to the service shop at your expense or pay the service technician's travel to the location of the product.

Fisher & Paykel Undertakes to:

Repair without cost to the owner either for material or labor any part of the product, the serial number of which appears on the product, which is found to be defective. In Alaska, you must pay to ship the product to the service shop or for the service technician's travel to your home. If the product is installed in a motor vehicle, boat or similar mobile facility, you must bring it to the service shop at your expense or pay for the service technician's travel to the location of the product. If we are unable to repair a defective part of the product after a reasonable number of attempts, at our option we may replace the part or the product, or we may provide you a full refund of the purchase price of the product (not including installation or other charges).

This warranty extends to the original purchaser and any succeeding owner of the product for products purchased for ordinary single-family home use.

All service under this limited warranty shall be provided by Fisher & Paykel or its Authorized Service Agent during normal business hours.

How long does this Limited Warranty Last?

Our liability under this limited warranty expires ONE YEAR from the date of purchase of the product by the first consumer.

Our liability under any implied warranties, including the implied warranty of merchantability (an unwritten warranty that the product is fit for ordinary use) also expires ONE YEAR (or such longer period as required by applicable law) from the date of purchase of the product by the first consumer. Some States do not allow limitations on how long an implied warranty lasts, so this limit on implied warranties may not apply to you.

Limited Warranty

This Warranty Does Not Cover

- A** Service calls that are not related to any defect in the product. The cost of a service call will be charged if the problem is not found to be a defect of the product. For example:
 1. Correct faulty installation of the product.
 2. Instruct you how to use the product.
 3. Replace house fuses, reset circuit breakers, correct house wiring or plumbing, or replace light bulbs.
 4. Correct fault(s) caused by the user.
 5. Change the set-up of the product.
 6. Unauthorized modifications of the product.
 7. Noise or vibration that is considered normal, for example, drain/fan sounds, refrigeration noises or user warning beeps.
 8. Correcting damage caused by pests, for example, rats, cockroaches etc.
- B** Defects caused by factors other than:
 1. Normal domestic use or
 2. Use in accordance with the product's user guide.
- C** Defects to the product caused by accident, neglect, misuse, fire, flood or Act of God.
- D** The cost of repairs carried out by non-authorized repairers or the cost of correcting such unauthorized repairs.
- E** Travel fees and associated charges incurred when the product is installed in a location with limited or restricted access. (eg airplane flights, ferry charges, isolated geographic areas).
- F** Normal recommended maintenance as set forth in the product's user guide.

If you have an installation problem contact your dealer or installer. You are responsible for providing adequate electrical, exhausting and other connection facilities.

We are not responsible for consequential or incidental damages (the cost of repairing or replacing other property damaged if the product is defective or any of your expenses caused if the product is defective). Some States do not allow the exclusion or limitation of incidental or consequential damages, so the above limitation or exclusion may not apply to you.

Limited Warranty

How to get Service

Please read your User Guide. If you then have any questions about operating the product, need the name of your local Fisher & Paykel Authorized Service Agent, or believe the product is defective and wish service under this limited warranty, please contact your dealer or call us at:

USA and Canada

TOLL FREE **1.888.9.FNP.USA (1.888.936.7872)**

or use the link at: www.fisherpaykel.com/locator/servicer/

You may be required to provide reasonable proof of the date of purchase of the product before the product will be serviced under this limited warranty.

Commercial Use

If you are using the product in a commercial setting (any use other than a single family dwelling), we agree to repair or replace, without cost to you for parts only, any defective parts, the serial number of which appears on the product. Our liability for these repairs expires ONE YEAR from the date of original purchase.

At our option we may replace the part or the product, or we may provide you a full refund of the purchase price of the product (not including installation or other charges). All service under this limited warranty shall be provided by Fisher & Paykel or its Authorized Service Agent during normal business hours.

No Other Warranties

This limited warranty is the complete and exclusive agreement between you and Fisher & Paykel regarding any defect in the product. None of our employees (or our Authorized Service Agents) are authorized to make any addition or modification to this limited warranty.

Warrantor: Fisher & Paykel Appliances, Inc.

If you need further help concerning this limited warranty, please call us at above number, or write to:

Fisher & Paykel Appliances, Inc.

5900 Skylab Road

Huntington Beach

CA 92647

This limited warranty gives you specific legal rights, and you may also have other rights which vary from state to state.

Copyright © Fisher & Paykel 2009. All rights reserved.
The product specifications in this booklet apply to the specific products and models described at the date of issue. Under our policy of continuous product improvement, these specifications may change at any time. You should therefore check with our Customer Care Center to ensure this booklet correctly describes the product currently available.

www.usa.fisherpaykel.com
www.fisherpaykel.ca

US CA
Smartload™ clothes dryer
Installation instructions and user guide
Published 02/2009
Part No. 395776