

website:<http://us.lge.com>

☎ 1-800-243-0000

24 HOURS A DAY, 7 DAYS A WEEK FOR LG CUSTOMER SERVICE
para el Servicio LG (Atención al Cliente) 24 horas al día, 7 días a la semana

LSC27990TT

SXS REFRIGERATOR

User's Guide

Please read this guide thoroughly
before operating and keep it handy
for reference at all times.

SXS REFRIGERATEUR

Manuel d'utilisation

Prière de lire attentivement le présent manuel
avant d'utiliser le réfrigérateur.
Conserver à portée de main pour pouvoir le
consulter à tout moment.

FRIGORÍFICO **SXS**

Guía de usuario

Lea detenidamente estas instrucciones
antes utilizar el frigorífico y guárdelas
como referencia para el futuro.

Table of Contents

Introduction	Entry	3
	Important safety instructions	3
	Identification of parts	4
Installation	Where to install	5
	Door removal	6
	Install the freezer and refrigerator compartment doors	7
	Water supply installation	7
	Water connection instruction guide	8
	Height adjustment	11
	External Equipment Connections	12
Operation	Setup	13
	Adjusting the temperatures and functions	13
	Temperature	14
	Dispenser	15
	Menu	16
	Shelf	37
	Humidity control in the vegetable compartment	37
	OptiFresh temperature bin	38
OptiFresh	38	
Suggestion on food storage	Location of foods	39
	Storing foods	40
Care and maintenance	How to remove and replace parts	41
	General information	44
	Cleaning	44
	Troubleshooting	45
	Warranty	50
	Zip code	151

Entry

The model and serial numbers are found on the inner case or back of refrigerator compartment of this unit. These numbers are unique to this unit and not available to others. You should record requested information here and retain this guide as a permanent record of your purchase. Staple your receipt here.

Date of purchase _____
 Dealer _____
 Dealer address _____
 Dealer phone _____
 Model _____
 Serial _____

Important safety instructions

Before use, this refrigerator must be properly installed and located in accordance with the installation instructions in this manual.

Never unplug your refrigerator by pulling on the power cord. Always grip the plug firmly and pull it straight out from the outlet.

When moving your appliance away from the wall, be careful not to roll over the power cord or to damage it in any way. Do not crush or damage the water line.

After your refrigerator is in operation, do not touch the cold surfaces in the freezer compartment, particularly when your hands are damp or wet. Skin could adhere to these extremely cold surfaces.

Unplug the power cord from the power outlet for cleaning or other requirements. Never touch it with wet hands because you can get an electric shock or be injured.

Never damage, bend, kink, pull out, or twist the power cord because damage to the power cord can cause product failure, fire, or electric shock. If you have doubts the appliance is properly grounded, consult a qualified electrician.

Never place glass products in the freezer because they may be broken from expansion when their contents are frozen.

Never put your hands within the ice storage bin of the automatic icemaker. You can be injured by the operation of the automatic icemaker.

The appliance is not intended for use by young children without supervision.

Young children should be supervised to ensure that they do not play with the appliance.

Never allow anyone to climb, sit, stand, or hang on the door. These actions may damage the refrigerator and even tip it over, causing severe personal injury.

Before you move your refrigerator into its final location, it is important to make sure you have the proper electrical connection. A 115 Volt, 60 Hz., AC only, 15 or 20 amp, fused and grounded single-outlet circuit is required. Use an outlet that cannot be turned off by a switch. Do not use an extension cord.

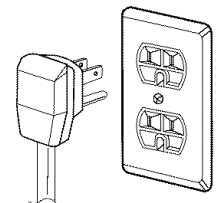

The refrigerator-freezer should be so positioned that the supply plug is accessible for quick disconnection in the event of an emergency.

If the supply cord is damaged, it must be replaced by the manufacturer or its service agent or a similarly qualified person in order to avoid any hazard.

Do not modify or extend the Power Cord length.

- It may cause electric shock or fire.



Recommended grounding method

Accessibility of supply plug

Supply cord replacement

Warning

Child entrapment warning

DANGER: Risk of child entrapment.

Before you throw away your old refrigerator or freezer take off the doors but leave the shelves in place so that children may not easily climb inside.

The appliance is not intended for use by young children without supervision.

Young children should be supervised to ensure that they do not play with the appliance.

Don't store

Don't store or use gasoline or other flammable vapor and liquids in the vicinity of this or any other appliance.

Grounding

In the event of an electric short circuit, grounding (earthing) reduces the risk of electric shock by providing an escape wire for the electric current.

In order to prevent possible electric shock, this appliance must be grounded.

Improper use of the grounding plug can result in an electric shock. Consult a qualified electrician or service person if the grounding instructions are not completely understood, or if you have doubts on whether the appliance is properly grounded.

Identification of parts

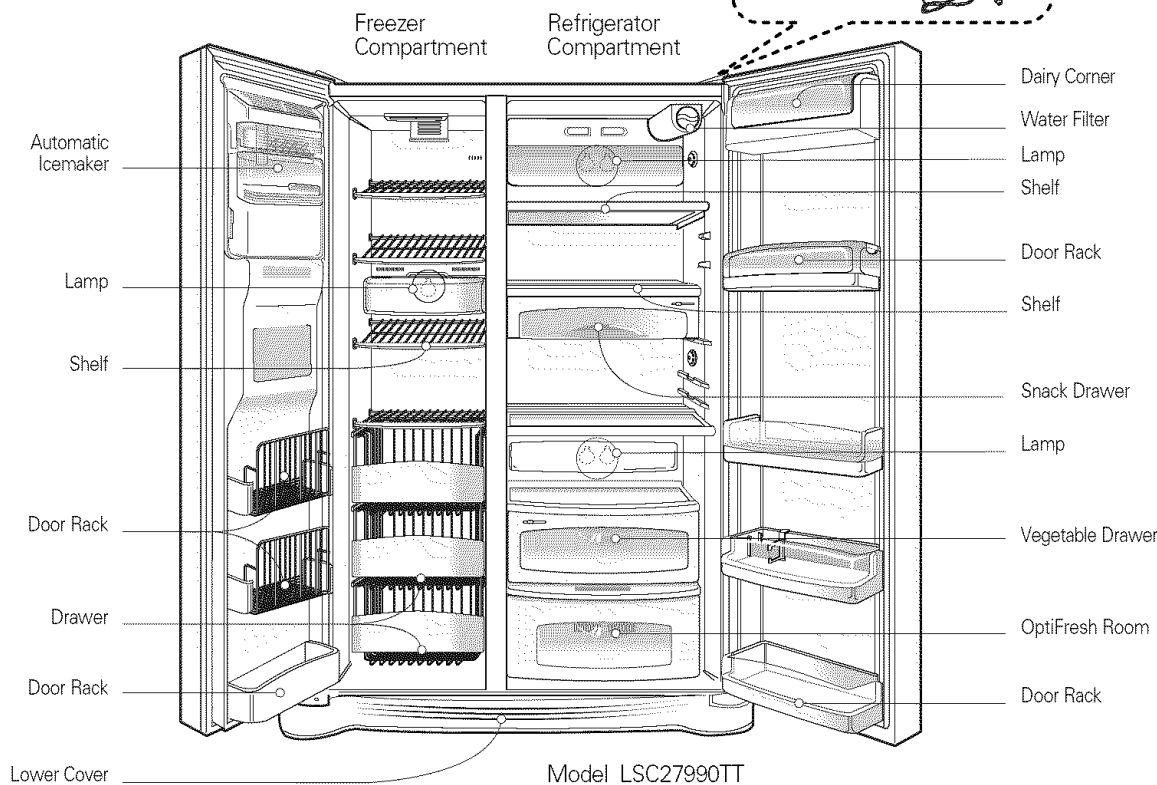
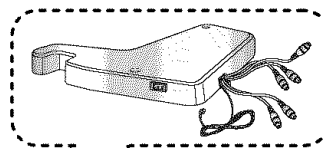

NOTE

- Parts, features, and options vary by model. Your model may not include every option.

Where to install

Strong and even floor

Unstable installation may cause vibration and noise. If the floor to install the refrigerator on is not even, make the refrigerator level by rotating the height adjusting screw.

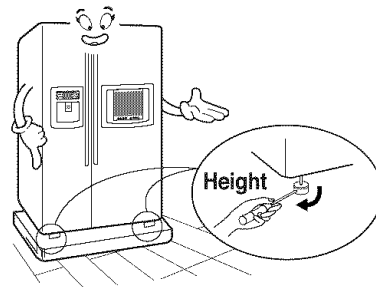

A proper distance from adjacent items

To ensure proper air circulation around the fridge-freezer, please maintain sufficient space on both the sides as well as top and maintain at least 2 inches (5 cm) from the rear wall.

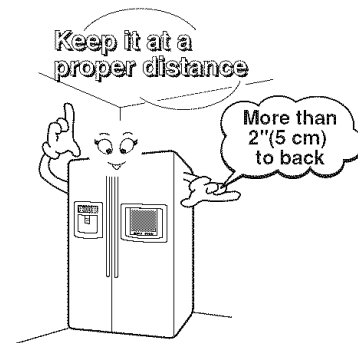

Where water supply can be easily connected in a dry place

Select a place where a water supply can be easily connected between the automatic ice maker and dispenser. Installing the refrigerator in a wet or damp area may cause rust and may be an electrical hazard.

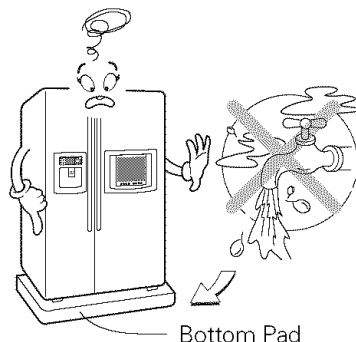

Where it is free from heat

If this refrigerator is installed where the ambient temperature is high, the freezing capacity is deteriorated and the cost of electricity used increases.

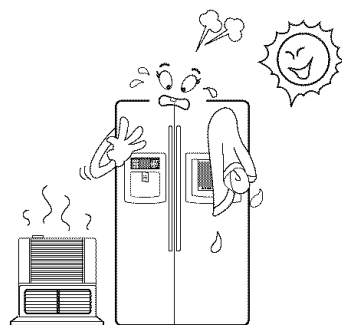

NOTE

- Install the refrigerator at a place where the ambient temperature is 5°C ~ 43°C (41°F ~ 110°F). Ambient temperature outside this range may cause product malfunction. Also, the tube between the dispenser and automatic ice maker may freeze.

Door removal

Warning

Electric Shock Hazard

Disconnect electrical supply to refrigerator before installing. Failure to do so could result in death or serious injury.

If your entrance door is too narrow for the refrigerator to pass through, remove the refrigerator door and pass the refrigerator laterally.

Remove the lower cover by lifting upward, and then pull up the water feed tube while pressing the release ring ① shown in the figure to the right.

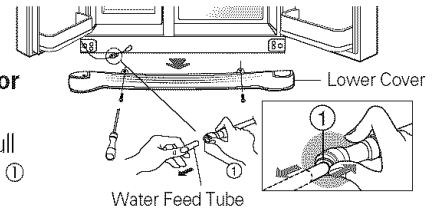

Remove lower cover and water feed tube

NOTE

- If a tube end is deformed or abraded, trim the part away. Disconnecting the tube under the door causes about 1/2 gallon (2 liters) water to flow out. Please put up a big container to prevent it.

Remove the freezer compartment door

1) Remove the hinge cover by loosening the screws. Disconnect all connections except the ground line.

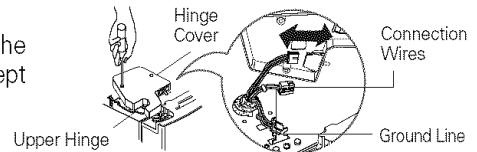

2) Remove the keeper by rotating it counter clockwise ① and then lifting the upper hinge up ②.

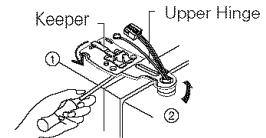

NOTE

- When removing the upper hinge, be careful that the door does not fall forward.

3) Remove the freezer compartment door by lifting it upward. This time, the door should be lifted enough for the water feed tube to be completely pulled out.

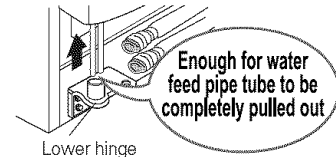

NOTE

- After removing the door, take it into the kitchen where you are installing the refrigerator. Lay it down on a blanket and be careful to avoid damaging the water feed tube.

Remove the refrigerator door

1) Loosen the hinge cover screws and remove the cover. Remove connection wire, if any, except for the ground line.

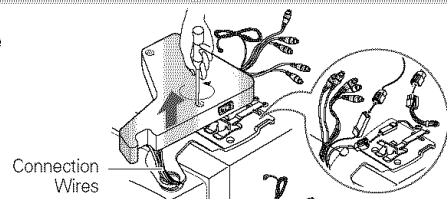

2) Remove keeper by rotating it clockwise (①) and then remove the upper hinge by lifting it up (②).

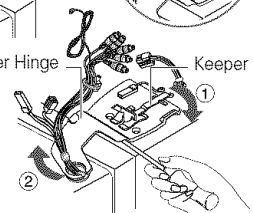

3) Remove the refrigerator compartment door by lifting it up.

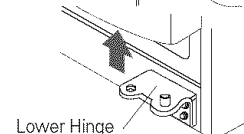

Pass the refrigerator

Pass the refrigerator laterally through the access door as shown in the right figure.

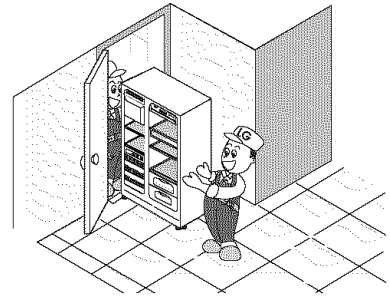

Install the freezer and refrigerator compartment doors

Mount them in the reverse sequence of removal after they pass through the access door.

Water supply installation

Before installation

- Automatic icemaker operation needs water pressure of 21~121 psi (1.5~8.5 kgf/cm²) (That is, an instant paper cup (6 oz. or 180 cc) will be fully filled within 3 seconds.)
- If water pressure is less than 21 psi (1.5 kgf/cm²). It is necessary to purchase a separate pressure pump for normal automatic icemaking and cool water feed.
- Keep the total length of the feed water pipe tube within 26' (8 m). Be careful for the tube to avoid being kinked. If the tube is longer than 26' (8 m), the pressure may drop to an unacceptable level.
- Install the water supply line where it will not be affected by heat.

Warning

- Connect to potable water supply only.

Disposal of the old appliance

This appliance contains fluids (refrigerant and lubricant) and is made of parts and materials which are reusable and/or recyclable. All the important materials should be sent to the collection center of waste material and can be reused after rework (recycling). For recycling, please contact the local agency.

Connecting the refrigerator to a water source

Warning

Water connection instruction guide

Read all directions carefully before you begin.

Connect to potable water supply only.

IMPORTANT

- If operating the refrigerator before installing the water connection, turn the icemaker to the **OFF** position to prevent operation without water.
- All installations must be in accordance with local plumbing code requirements.
- Use copper tubing and check for leaks.
- Install copper tubing only in areas where temperatures will remain above freezing.
- It may take up to 24 hours for your icemaker to begin producing ice.

Tools required

- Standard screwdriver
- 7/16-inch and 1/2-inch open-end wrenches or two adjustable wrenches
- 1/4-inch nut driver
- 1/4-inch drill bit
- Hand drill or electric drill (properly grounded)

NOTE

- Your refrigerator dealer has a kit available with a 1/4-inch saddle-type shut-off valve, a union, and copper tubing. Before purchasing, make sure a saddle-type valve complies with your local plumbing codes. Do not use a piercing-type or 3/16-inch saddle valve which reduces water flow and clogs more easily.

Cold water supply

The icemaker water valve contains a flow washer which is used as a water pressure regulator.

The icemaker needs to be connected to a cold water line with water pressure 21 psi (lb/inch²)

Connect the tubing to water line

1. Unplug the refrigerator or disconnect power.
2. Turn OFF the main water supply. Turn on the nearest faucet to relieve the pressure on the line. It may help to open an outside faucet to allow the water to drain from the line in the house.
3. Find a 1/2-inch vertical COLD water pipe near the refrigerator.

NOTE

- Horizontal pipe will work, but the following precaution must be taken: Drill on the top of the pipe, not the bottom. This will help keep water away from the drill. This also keeps normal sediment from collecting in the valve.

4. To determine the length of copper tubing you will need, measure from the connection on the lower left rear of the refrigerator to the water pipe. Add 7 feet (2.1m) to allow for moving refrigerator for cleaning. Use 1/4-inch O.D. (outside diameter) copper tubing. Be sure both ends of copper tubing are cut square.
5. Using a drill, drill a 1/4-inch hole in the cold water pipe you have selected.
6. Fasten shut-off valve to cold water pipe with pipe clamp. Be sure the outlet end is solidly in the 1/4" drilled hole in the water pipe and the washer is under the pipe clamp. Tighten the packing nut. Tighten the pipe clamp screws carefully and evenly so the washer makes a watertight seal. Do not overtighten or you may crush the copper tubing, especially if soft (coiled) copper tubing is used. Now you are ready to connect the copper tubing.
7. Slip the compression sleeve and the compression nut onto the copper tubing as shown. Insert the end of the tubing into the outlet end squarely as far as it will go. Tighten the compression nut onto the outlet end with a wrench. A flare nut wrench works best, but an open end wrench will suffice. Do not overtighten.
8. Place the free end of the tubing into a container or sink, and turn on the main water supply. Flush out the tubing until the water is clear. Turn off the shutoff valve on the water pipe. Coil the copper tubing as shown below.

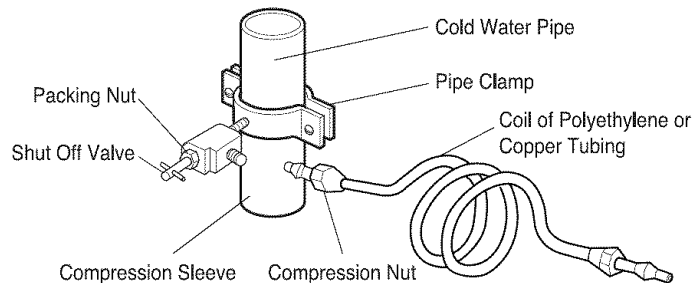

Connect the tubing to the refrigerator

Before making the connection to the refrigerator, be sure the refrigerator power cord is not plugged into the wall outlet.

- If your refrigerator does not have a water filter, we recommend installing one. If your water supply has sand or particles, that could clog the screen of the refrigerator's water valve. Install the filter in the water line near the refrigerator.

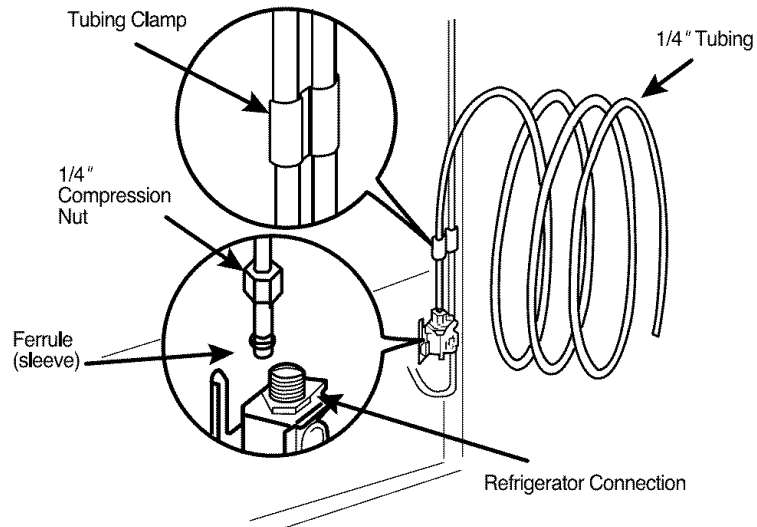

1. Remove the plastic flexible cap from the water valve.
2. Place the compression nut and ferrule (sleeve) onto the end of the tubing as shown.
3. Insert the end of the copper tubing into the connection as far as possible. While holding the tubing, tighten the fitting.

Turn the water on at the shutoff valve

Tighten any connections that leak.

■ Plug In the Refrigerator

Arrange the coil of copper tubing behind the refrigerator so it does not vibrate against the back of the refrigerator or against the wall. Push the refrigerator back to the wall.

■ Start the Icemaker

Set the icemaker switch to the ON position. The icemaker will not begin to operate until it reaches its operating temperature of 15 °F (-9 °C). It will then begin operation automatically.

Height adjustment

If the freezer compartment door is lower than the refrigerator compartment door

Level them by inserting a flat (- type) driver into the groove of the left height adjusting screw and rotating it clockwise (①).

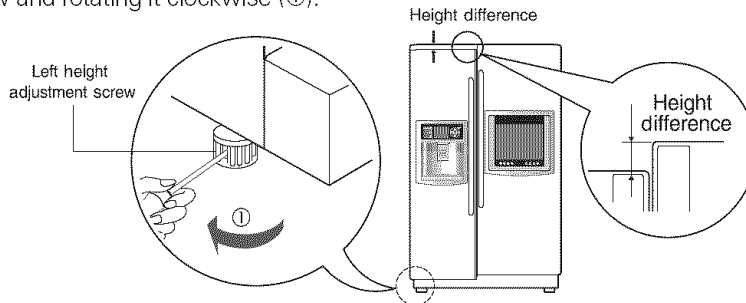

If the freezer compartment door is higher than the refrigerator compartment door
- first method

Level them by inserting a flat (- type) driver into the groove of the right height adjusting screw and rotating it clockwise (①).

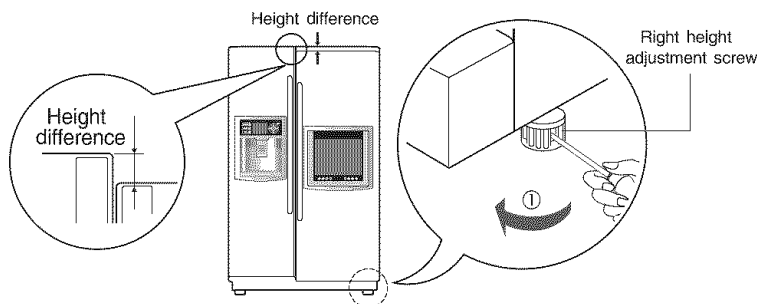

If the freezer compartment door is higher than the refrigerator compartment door
- second method

Adjust the level when the refrigerator door is lower than the freezer door during the use of the refrigerator.

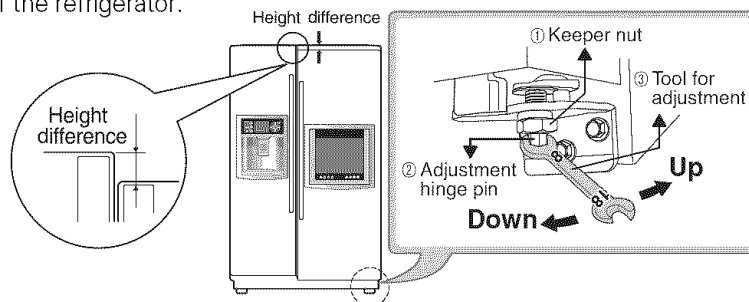

1. Using the wide side of the tool for adjustment ③, turn the keeper nut ① (↻) clockwise to loosen the Keeper nut.
2. Using the narrow side of the tool for adjustment, turn the adjustment hinge pin ② (↻) clockwise or (↺) counterclockwise to level the refrigerator and freezer door.
3. After setting the level of the door, turn the keeper nut (↺) counterclockwise to tighten.

CAUTION

Do not force too hard to level the height. The hinge pin can be pulled out. (Adjustable range of height is a maximum of 2" (5 cm))

After leveling the door height

The refrigerator door will close smoothly by raising the front side by adjusting the height adjusting screw. If the door does not close properly because it is improperly adjusted, the performance of the refrigerator will be affected.

External Equipment Connections

Antenna Connection

- Antenna or Cable Service without a Cable Box Connections
- For optimum picture quality, adjust antenna direction if needed.

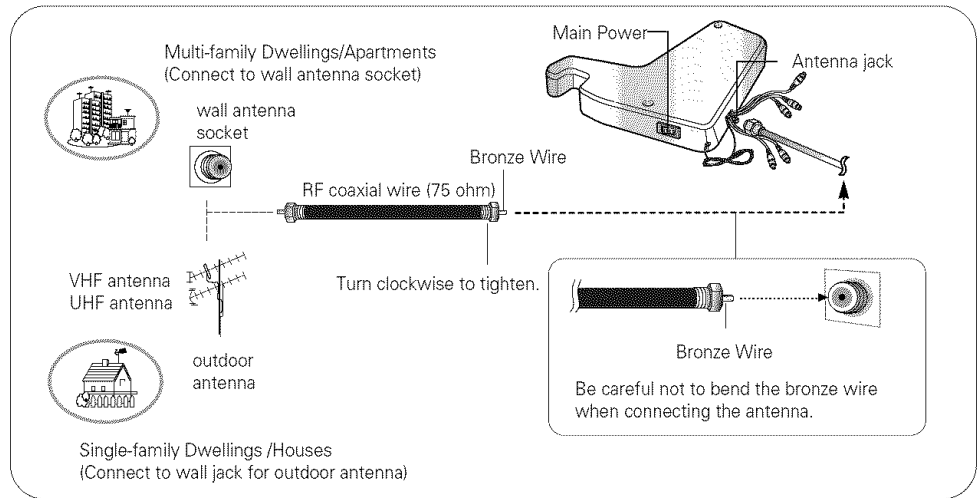

- In a poor signal area to improve picture quality, purchase and install a signal amplifier.
- If the antenna is not installed properly, contact your dealer for assistance.
- Turn the end of the cable to the clockwise direction to be connected to the connector located at the top of the refrigerator.

Incorrect connection may cause a bad quality.

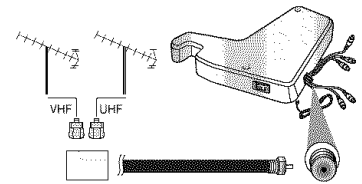

Connecting a VCR / DVD

Connection

1. Connect the audio/video out sockets of the VCR to audio/video in sockets of the set.
2. Press the **INPUT** button to select **Component**.
3. Press the **PLAY** button on the VCR.
The VCR playback picture appears on the screen.

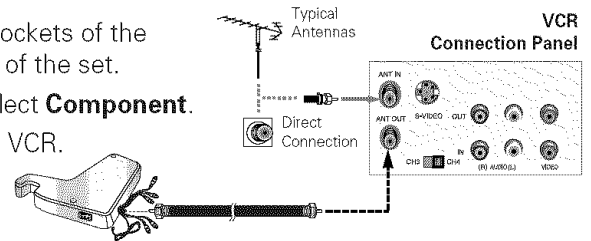

NOTE

- If you have a mono VCR, connect the audio cable from the VCR to the **AUDIO L/MONO** socket of the set.

Cable TV Connections

- After subscribing to a local cable TV service and installing a converter, you can watch cable TV programming.
- For further cable TV information, contact a local cable service provider.

Connection

1. Use the **INPUT** button on the remote control to select **TV**.
2. Tune to cable service provided channels using the cable box.

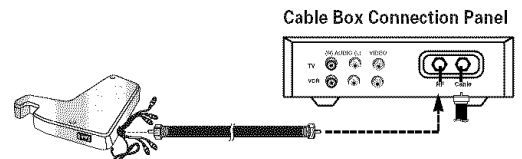

Setup

When your refrigerator is first installed, allow it to stabilize at normal operating temperatures 2~3 hours prior to filling it with fresh or frozen foods. If operation is interrupted, wait 5 minutes before restarting.

Adjusting the temperatures and functions

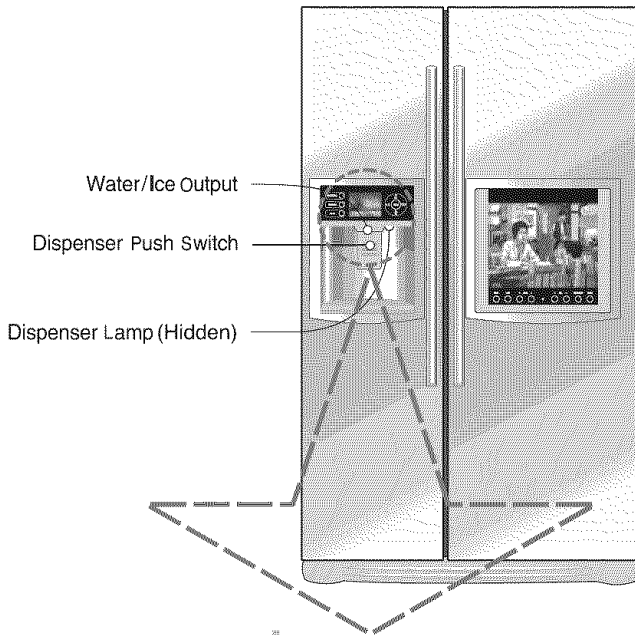

About defective pixels

This LCD display contains hundreds of thousands of individual pixels. LCD displays typically contain a small number of pixels that do not function normally. Your display has been inspected and is in compliance with manufacturer's specifications, indicating that any pixel defects do not affect the operation or use of your display. On a display of this size, 4 or fewer defective pixels are considered to be normal and are not grounds for exchange or refund.

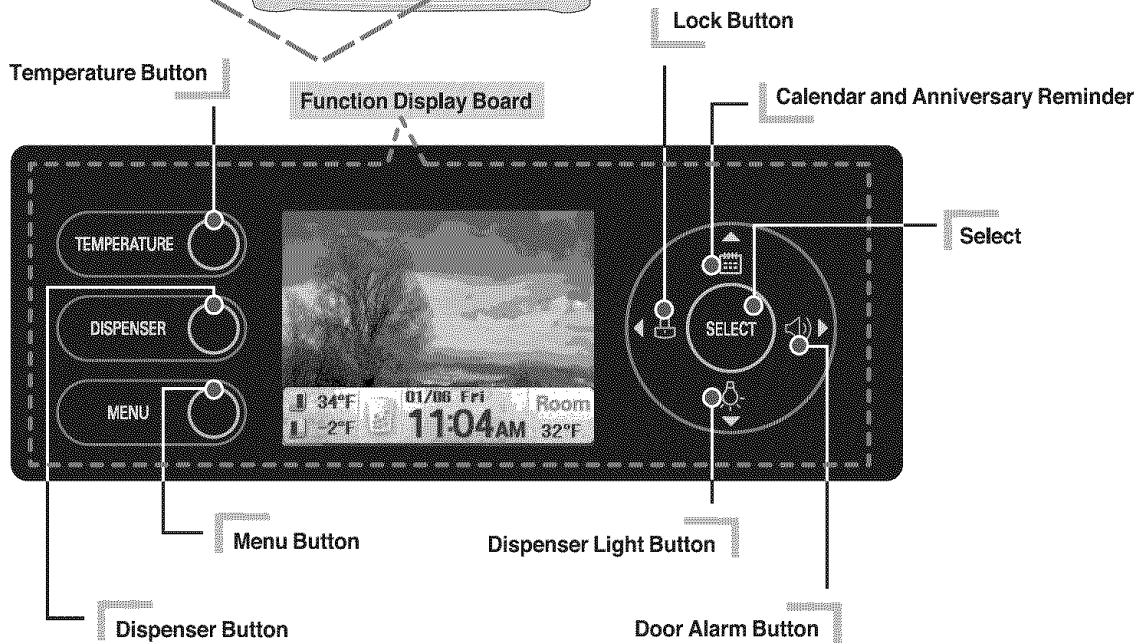

NOTE

- Your model may not include every option.
- The LCD backlight lamp of this product contains mercury. Dispose according to Local, State or Federal Laws.

Temperature

Refrigerator/Freezer

- You can adjust the freezer and refrigerator temperature.



Press the **TEMPERATURE** button.

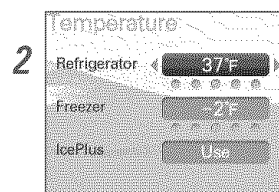

Using the ▲ or ▼ button, select the desired refrigerator.

3 Select the temperature using the ◀ or ▶ button.

Refrigerator temperature options: 46, 41, 37, 34, or 32°F

Freezer temperature options: 7, 1, -2, -5, or -8°F

4 Press the **SELECT** button.

5 Return to the standby screen.

IcePlus

- For quick freezing.

- The standby screen is shown during  IcePlus operation.



Press the **TEMPERATURE** button.

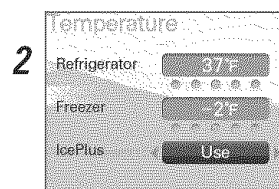

Press the ▲ or ▼ button to select **IcePlus**.

3 Press the ◀ or ▶ button to select **Use**. [Use] <--> [Not in Use]

4 Press the **SELECT** button.

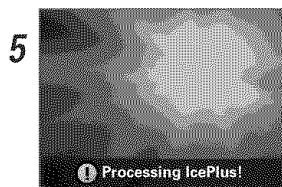



6 Return to the standby screen.

- The indicated set temperature is not the actual temperature within the refrigerator but the target temperature. The actual internal temperature can differ, especially if the door is opened and warm food was recently stored.

- Initially the refrigeration is weak. Adjust the temperature as mentioned above after using the refrigerator for at least 2 to 3 days.

Dispenser

Crush/Water/Cube

- You can select from Crush, Water or Cube options.
- When the dispenser is in use, the active option is indicated in the standby screen.
- Crush , Water , Cube .

- 

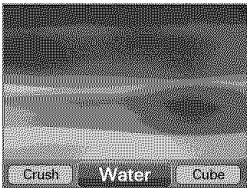
Press the **DISPENSER** button.
- 

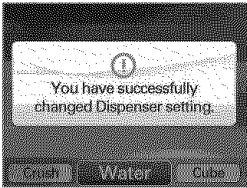
Select the desired option using the ◀ and ▶ buttons.
[Crush] <--> [Water] <--> [Cube]
- Press the **SELECT** button.
- 
- Return to the standby screen.

Automatic icemaker

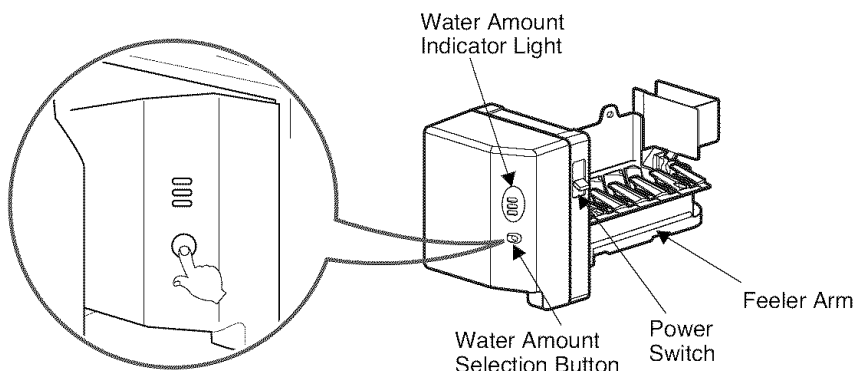

- The automatic icemaker can automatically make 6 cubes at a time, 70~120 pieces per day. This quantity may vary by circumstance, including ambient temperature, door opening, freezer load. etc.
- Icemaking stops when the ice storage bin is full.
- If you don't want to use the automatic icemaker, turn the icemaker switch to OFF. If you want to use automatic icemaker again, change the switch to ON.
- The water amount will vary depending on the water amount selection button. Setting, as well as the water pressure of the connected water line.

NOTE

- It is normal that a noise is produced when ice drops into the ice storage bin.

Menu

You can select from Information, Gourmet Recipes, Refrigerator, Settings, and Photo Album function.



Press the **MENU** button.

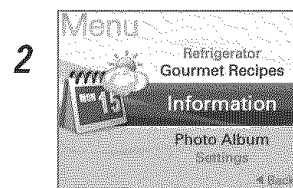

3 Select the menu using the ▲ and ▼ buttons.

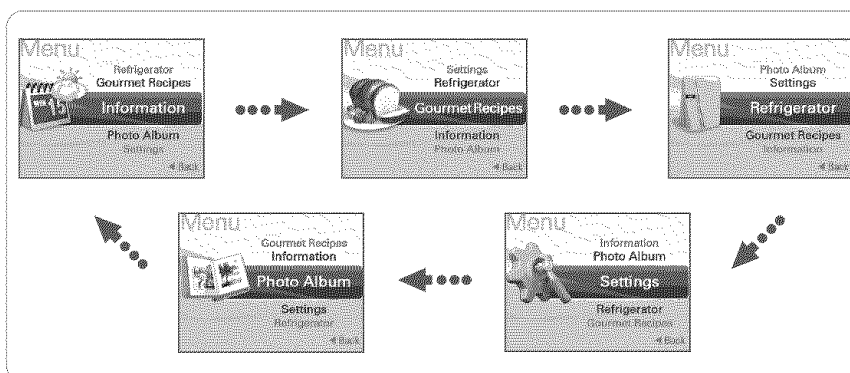

4 Press the **SELECT** button.

5 You will see the detail menu.

Information

You can select from Weather Forecast, Anniversary Reminder, Date and Time Setting, or Timer function.

☐ **Weather Forecast**

- Receives and displays the weather and temperature for 5 days, including the current day.
- Reception of weather forecast information received and displayed on the screen is subject to vary depending on your region and location of refrigerator.
- Thereby LG does not guarantee and will not be held responsible for accuracy of the weather information.
- Check your zip code in this manual pages 151 or www.ambientdevices.com/cat/device/coverage.html
- Weather forecast information is only available in U.S.A

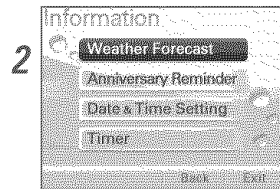
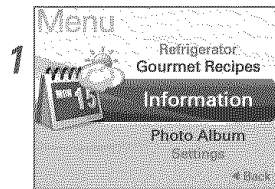

Press the ▲ or ▼ button to select **Weather Forecast**.

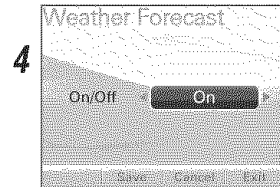
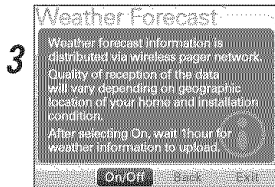

Press the ◀ or ▶ button to select **On**.

Press the ◀ or ▶ button to select **On/Off**.

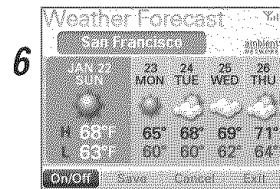
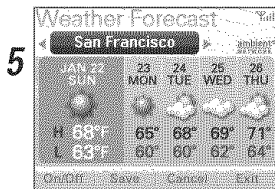

Select the desired region using the ◀ or ▶ button.

7 Return to the **Information** menu.

□ **Anniversary Reminder**

- Register the anniversary date.
-  Select the Anniversary reminder using the button.

< To set a new date >

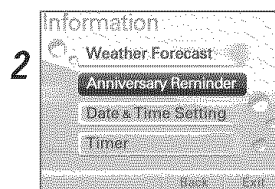
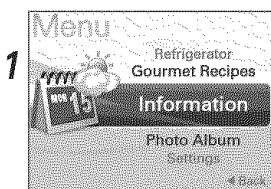

Press the ▲ or ▼ button to select **Anniversary Reminder**.

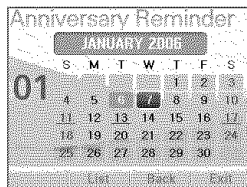

Select the month using the ◀ or ▶ button.

Press the ▼ button and then select the date using the ◀ or ▶ button.



Select the menu using the ▲ or ▼ button.

Select the advance time using the ◀ or ▶ button.

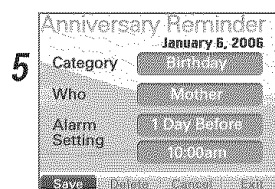

Press the ▼ button to select **Save**.

6 Return to the **Information** menu.

The anniversary reminder alarm goes off



The alarm will go off at the set date and time, and the anniversary will be displayed in the screen.

< To view the anniversary list >

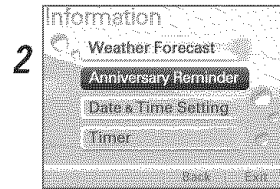
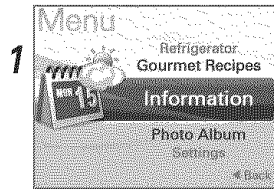

Press the ▲ or ▼ button to select **Anniversary Reminder**.



Press the ▲ or ▼ button to select **List**.

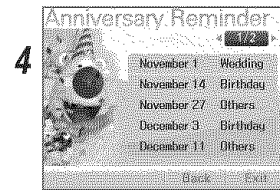

You can check the detail menu using the ◀ or ▶ button.

□ **Data & Time Setting**

To set the date and time.

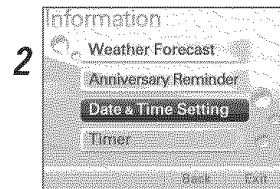
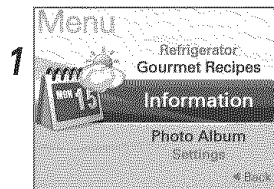

Press the ▲ or ▼ button to select **Date & Time Setting**.

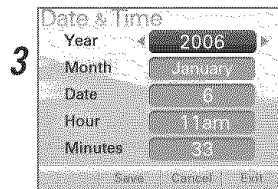

Select the menu using the ▲ or ▼ button.

Select the value using the ◀ or ▶ button.

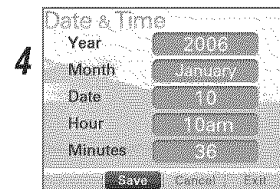

Press the ▼ button to select **Save**.

5 Return to the **Information** menu.

□ **Timer**

To set the alarm.

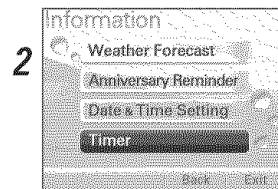
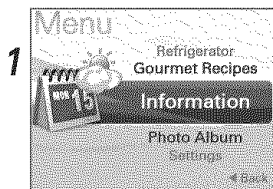

Press the ▲ or ▼ button to select **Timer**.

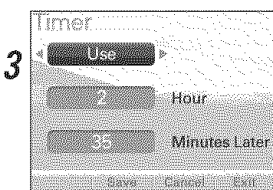

Select the time using the ◀ or ▶ button.

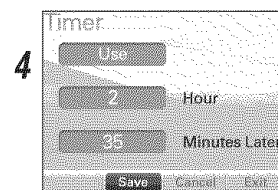

Press the ▼ button to select **Save**.

5 Return to the Information menu.

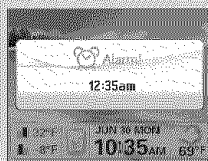

- The alarm will go off at the set time, and the timer image will be displayed in the screen.

Gourmet Recipes

Select the recipe after selecting the menu category of dish.

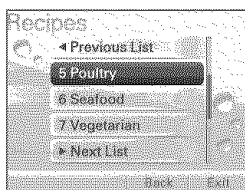
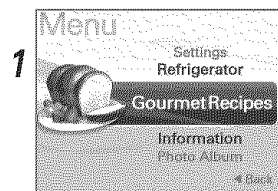

Select the menu category using the ▲ or ▼ button.

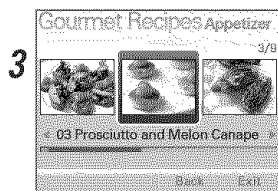

You can select the dish using the ◀ or ▶ button.

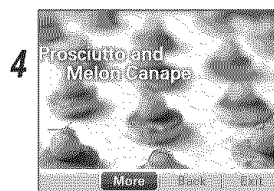

Press the ▼ button to select **More**.

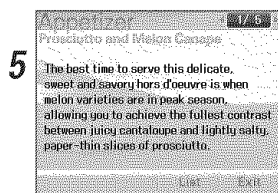

You can select the detail menu using the ◀ or ▶ button.

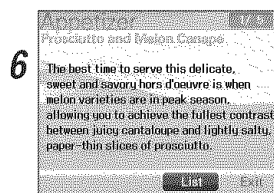

Press the ▼ button to select **List**.

7 Return to the **Gourmet Recipes** menu.

Refrigerator

You can select from Filter reset, Door alarm, Dispenser light, Manual, and Service Call functions.

❑ Filter Reset

Reminds you when to replace the filter.

< When the filter exchange date is still not due. >

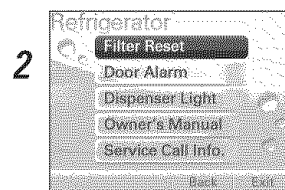
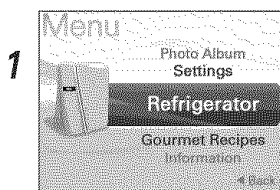

Press the ▲ or ▼ button to select **Filter Reset**.

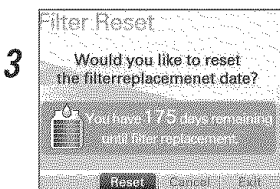

Press the ◀ or ▶ button to select **Reset**.

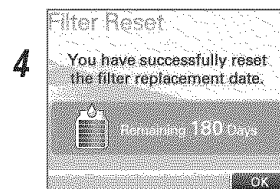

Press the **SELECT** button.

5 Return to **Refrigerator** menu.

< When the filter exchange date is overdue. >

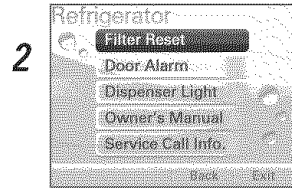
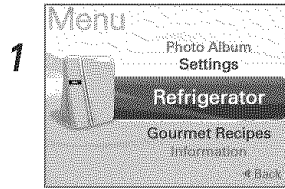

Press the ▲ or ▼ button to select **Filter Reset**.

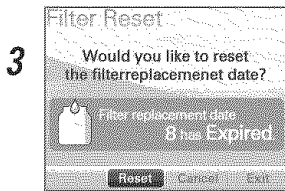

Press the ◀ or ▶ button to select **Reset**.

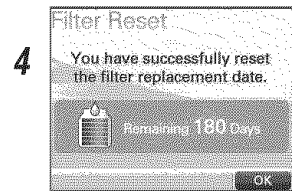

Press the **SELECT** button.

5 Return to **Refrigerator** menu.

- You will see a message notifying you how long it will be before you need to change the filter.

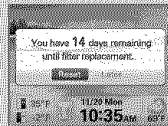

Press the ◀ or ▶ button to select **Reset**.



Press the **SELECT** button.

Return to the standby screen.

- If you choose to cancel filter exchange setting.



Press the ◀ or ▶ button to select **Later**.



You will see the filter exchange sign in the standby screen.

□ Door Alarm

This is the function of notifying you every 30 seconds that the refrigerator door is open for more than 1 minute.

-  You can turn the door alarm on or off.

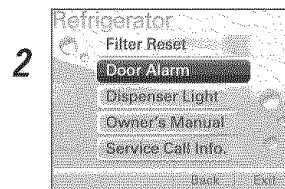
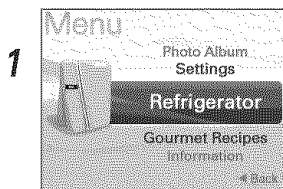

Press the ▲ or ▼ button to select **Door Alarm**.

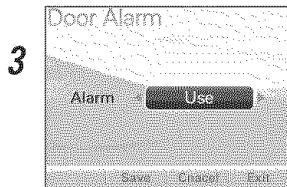

Press the ◀ or ▶ button to select **Use** or **Not in Use**.

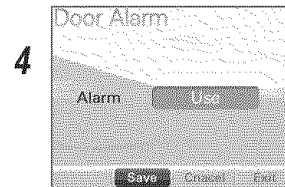

Press the ▼ button to select **Save**.

5 Return to the **Refrigerator** menu.

- You will see the door alarm message.



- When using the Door Alarm

This notifies you every 30 seconds that the refrigerator door is open for more than 1 minute.

- When not using the Door Alarm

The alarm will not go off even when the refrigerator door is open.

❑ **Dispenser Light**

This function controls the LED lamp located on the dispenser.

-  Press this icon turn the dispenser light on or off.

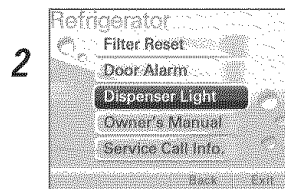
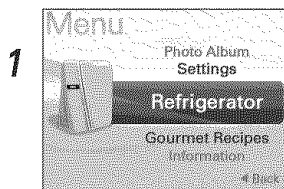

Press the ▲ or ▼ button to select **Dispenser Light**.

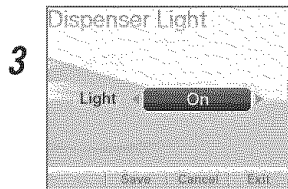

Press the ◀ or ▶ button to select **On**.

[On] <--> [Off]

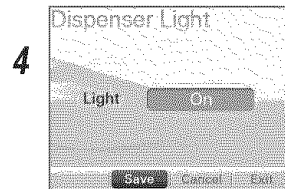

Press the ▼ button to select **Save**.

5 Return to the **Refrigerator** menu.

- **When On is selected**, the dispenser light is always on.
- **When Off is selected**, the dispenser light is turned on only when the dispenser lever is pressed.

❑ **Owner's Manual**

You can select from Key Guide, Tem. Adjustment, Child Lock, Weather Forecast, Proper Food Storage, Fridge Maintenance Guide, Freezer Maintenance Guide or Elimination of Odor function.

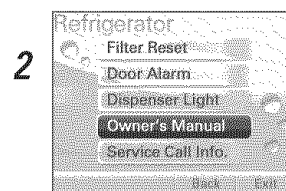
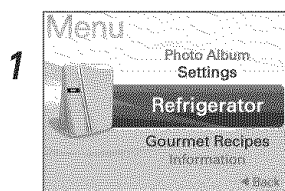

Press the ▲ or ▼ button to select **Owner's Manual**.

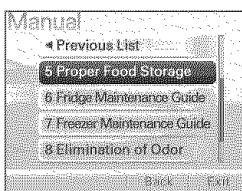
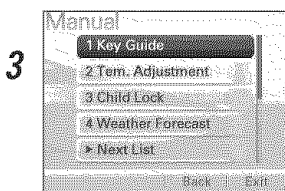

Select the menu using the ▲ or ▼ button.

4 Press the **SELECT** button.

5 Select the detail menu using the ◀ or ▶ button.

6 Press the ▼ button to select **List**.

7 Return to Refrigerator menu.

1. Key Guide

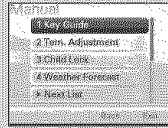

Press the ▲ or ▼ button to select **Key Guide**.

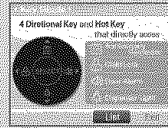

You will see the detail menu.

2. Tem. Adjustment

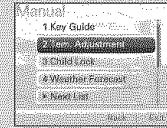

Press the ▲ or ▼ button to select **Tem. Adjustment**.

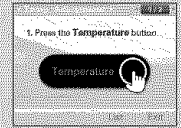

You can check the detail menu using the ◀ or ▶ button.

3. Child Lock

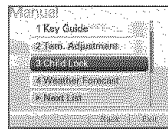

Press the ▲ or ▼ button to select **Child Lock**.

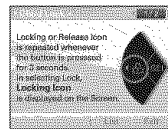

You can check the detail menu using the ◀ or ▶ button.

4. Weather Forecast

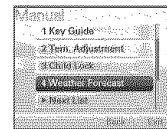

Press the ▲ or ▼ button to select **Weather Forecast**.

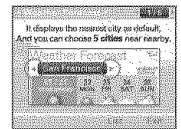

You can check the detail menu using the ◀ or ▶ button.

5. Proper Food Storage

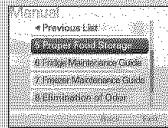

Press the ▲ or ▼ button to select **Proper Food Storage**.



You can check the detail menu using the ◀ or ▶ button.

6. Fridge Maintenance Guide

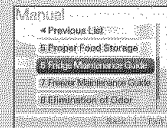

Press the ▲ or ▼ button to select **Fridge Maintenance Guide**.



You can check the detail menu using the ◀ or ▶ button.

7. Freezer Maintenance Guide



Press the ▲ or ▼ button to select **Freezer Maintenance Guide**.



You can check the detail menu using the ◀ or ▶ button.

8. Elimination of Oder

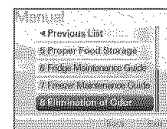

Press the ▲ or ▼ button to select **Elimination of Oder**.



You can check the detail menu using the ◀ or ▶ button.

❑ **Service Call Info.**

This shows the number to call for service in the US or Canada.

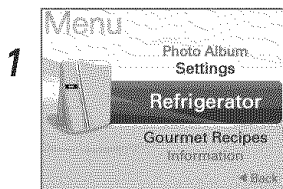

Press the ▲ or ▼ button to select **Service Call Info.**



You will see the detail menu.

Settings

You can select from Display Image, Display Theme, Power Saver, Screen Backlight/Button Sound, or °C/°F Setting function.

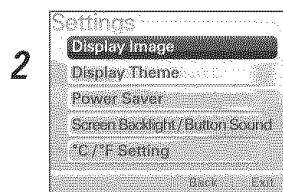
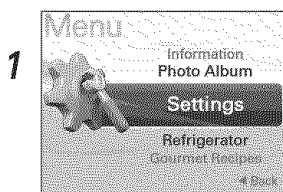

Select the menu using the ▲ or ▼ button.

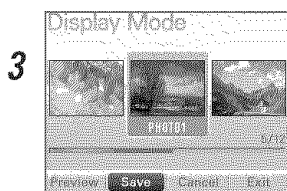

Select and Save the menu you want using the ◀ or ▶ button.

4 Return to the **Settings** list menu.

□ **Display Image**

You can select the standby screen setting.

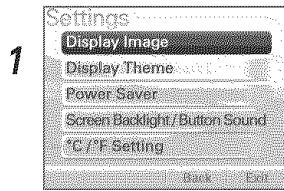

Press the ▲ or ▼ button to select **Display Image**.

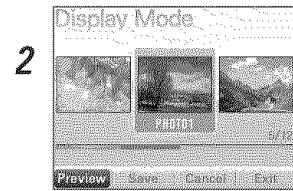

Select the desired photo using the ◀ or ▶ button.

Press the ▼ button to select **Preview**.

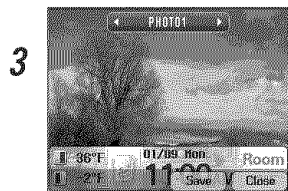

You can preview other standby screens using the ◀ or ▶ button.

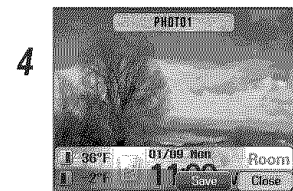

Press the ▼ button to select **Save**.

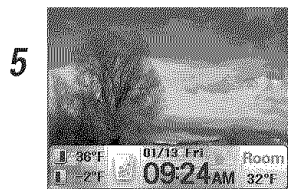

□ **Display Theme**

You can select the screen theme setting.

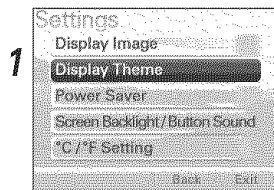

Press the ▲ or ▼ button to select the **Display Theme**.

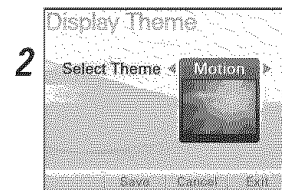

Select the menu using the ◀ or ▶ button.

Press the ▼ button to select **Save**.

[Character] <-> [Motion]

□ **Power Saver**

You can select the Power Saver function.

< **When Power Saver function is selected** >

- When selecting [Use of Power Saver], the LCD screen backlight turns off after eclipse of designated time.

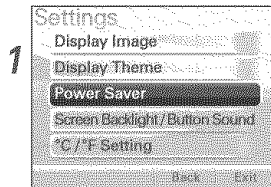

Press the ▲ or ▼ button to select **Power Saver**.

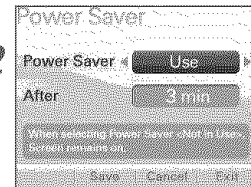

Press the ◀ or ▶ button to select **Use**.

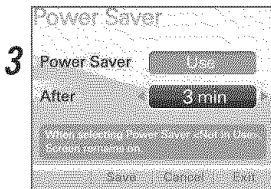

Select the desired time using the ◀ or ▶ button.
[1min] <--> [3min] <--> [5min]

4 The Power Saver turns the display off at the preset time.

< **When Power Saver function is not selected** >

- When selecting [Not in Use of Power Saver], the LCD screen is converted to Screen Protector after a minute.

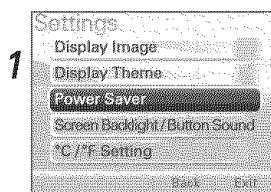

Press the ▲ or ▼ button to select **Power Saver**.

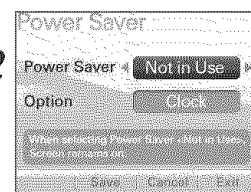

Press the ◀ or ▶ button to select **Not in Use**.

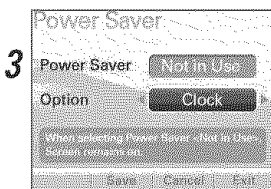

Select the menu using the ◀ or ▶ button.



[Clock]



[Photo]



[Not in Use]

- When you select the **Photo**, the pictures saved in the photo album will be shown in slideshow.
- When selecting **Not in Use**, the current standby screen is saved as Screen Saver.

❑ **Screen Backlight/Button Sound**

- You can adjust the screen brightness.
- When selecting the button sound, you can turn the button sound on or off.

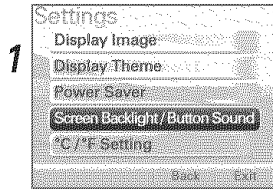

1

Press the ▲ or ▼ button to select **Screen Backlight/Button Sound**.

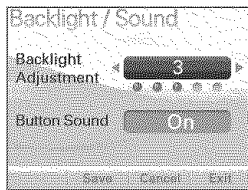

2

Select the brightness value using the ◀ or ▶ button.

Press the ▼ button to select **Save**.

[1 <--> 2 <--> 3 <--> 4 <--> 5]

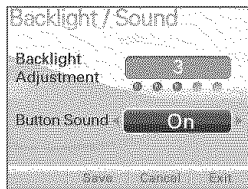

Select and Save the menu you want using the ◀ or ▶ button.

[On] <--> [Off]

❑ **°C/°F Setting**

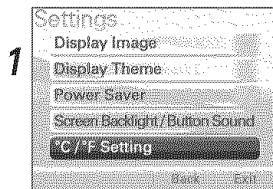

1

Press the ▲ or ▼ button to select **°C/°F Setting**.

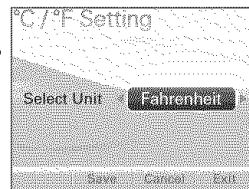

2

Select the menu you want using the ◀ or ▶ button.

[Centigrade] <--> [Fahrenheit]

Press the ▼ button to select **Save**.

Photo Album

You can register a photo or setup the standby screen.

< When setting to the standby screen >

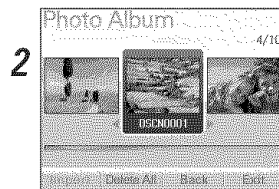
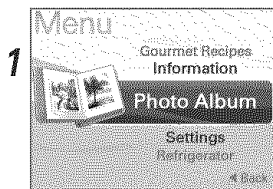

Select the desired photo using the ◀ or ▶ button.

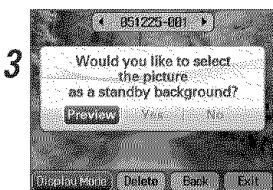

Press the ▼ button to select **Display Image**.
Press the ◀ or ▶ button to select **Preview**.



Press the ◀ or ▶ button to select **Save**.

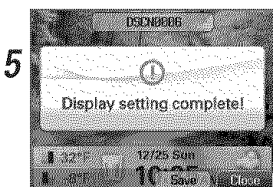

6 Return to the standby screen.

< When deleting >

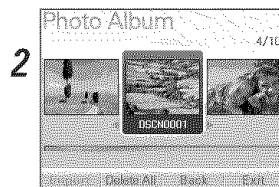
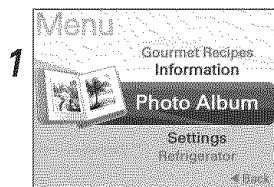

Select the desired photo using the ◀ or ▶ button.



Press the ▼ button to select **Delete**.

Press the ◀ or ▶ button to select **Yes**.



Press the ◀ or ▶ button to select **Save**.

5 Return to the standby screen.

< When deleting all >

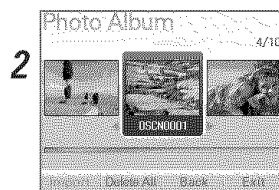
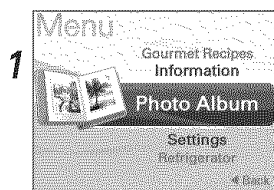

Press the ▼ button to select **Delete All**.



Press the ◀ or ▶ button to select **Yes**.

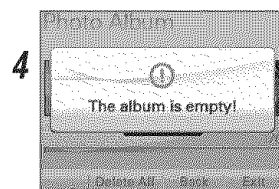

Return to the standby screen.

< When registering the photo >



When you connect the USB Memory Stick to the USB port, it reads the photo data and adds the album list.

< When using USB Memory Stick >

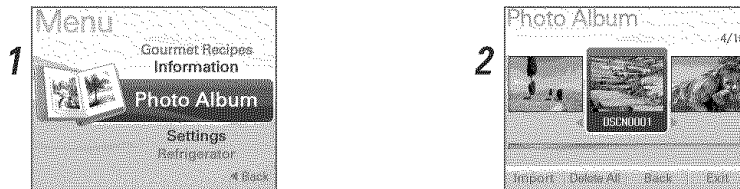

When selecting **Photo Album** and then connecting the USB Memory Stick, **Import** item is activated.



When selecting **Import**, it reads data from the USB Memory Stick. The Pop-up screen appears to inform progress process during reading.

After setting up desired photo from data read, select **Import**.

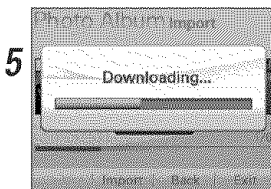

After **Import Check** popup screen appears, you can check photo from the photo album list.

- Position of USB Memory Stick for refrigerator.
- If desiring to use the USB Memory Stick, firstly select the photo album item and then insert the USB Memory Stick.
- It takes several seconds if reading photo from the USB Memory Stick.
- Use the product where photo is saved in the USB. If any photo are not saved, firstly save photo in the USB Memory Stick.
- The Avatar Display applied to this refrigerator uses O/S(Window CE), which recognition depends on the kinds of USB Memory Stick. When the USB which was recognized before, is not recognized currently, make it authorization again after powering off.

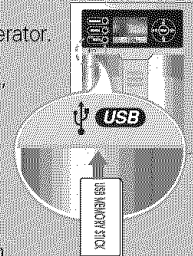

Lock

Lock can be used to disable the buttons and prevent tampering with the settings.

-  Select Lock using the buttons.
- Lock or unlock buttons and dispenser by pressing down the button for 3seconds.
- When lock is selected, the dispenser and buttons will be locked and will not operate.
- When lock is selected, the lock icon will appear on the screen.

< To set the Lock >

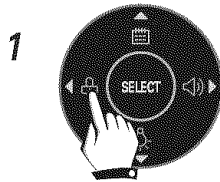

When you see this message, press the **Lock** button for 3 seconds.

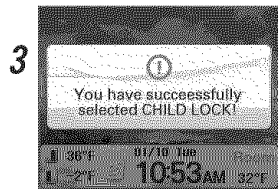

You will see this message.

4 Return to the standby screen.

< To cancel the Lock >

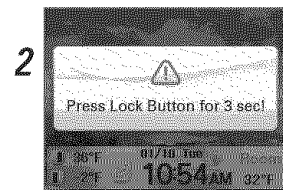
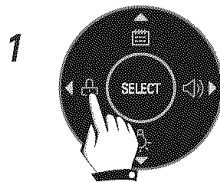

When you see this message, press the **Lock** button for 3 seconds.

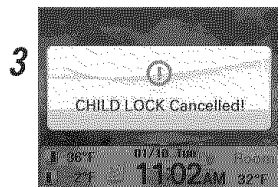

You will see this message.

4 Return to the standby screen.



Pressing the Refrigerator button when the Lock is set will display this message.

Other functions***Ambient Temperature Display Window.***

- Temperature is displayed only between 16°F ~ 120°F (-9°C ~ 49°C).
- Temperature less than 15°F (-9°C) is indicated with LO and temperature more than 121°F (49°C) is indicated with HI.

Room
32°F

Diagnostic (failure detection) function

- The diagnostic function automatically detects failure when failure is found in product during the use of refrigerator.
- If your refrigerator fails, do not turn off the power. Call 1-800-243-0000 24/7 and select the option to locate an authorized servicer or call our support line for assistance. Turning off the appliance will make it more difficult for the service technician to determine the problem.

How ice/cold water is supplied

Water is cooled while stored in the water tank in freezer door, and then sent to the dispenser.

Ice is made in the automatic icemaker and sent to the dispenser.

Cautions**Throw away the ice (about 20 pieces) and water (about 7 glasses) first made after refrigerator installation.**

This is also necessary when the refrigerator has not been used for a long time.

Keep children away from the dispenser.

Children may play with or damage the controls.

Be careful that food does not block the ice passage.

If foods are placed at the entrance of ice passage, the dispenser may malfunction. The passage may also become blocked with frost if only crushed ice is used. Remove the frost that accumulates.

Storing cans or other items in the ice bin may damage the icemaker or the container may burst.**Never use thin crystal glass or crockery to collect ice.**

Such glasses or containers may be broken, and glass fragments could be in the ice.

Put ice first into a glass before filling water or other beverages.

Water may be splashed if ice is added to existing liquid in a glass.

Keep your hands out of the ice door and passage.

You might break something or injure yourself.

Never remove the ice maker cover.**Shake the ice bin occasionally to level the ice in it.**

Sometimes the ice piles up near the icemaker, causing the icemaker to misinterpret the bin level and stop producing ice.

If you find ice or water dispensed unexpectedly, contact an Authorized Service Center. (Call 1-800-243-0000 24/7 and select the option to locate an authorized servicer.)**Never use too narrow or deep glass.**

Ice may be jammed in the ice passage and, thus, the refrigerator may fail.

Keep the glass at a proper distance from ice outlet.

A glass too close to the outlet may prevent ice from coming out.

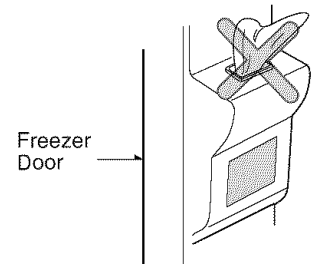

Shelf height adjustment

Shelf

The refrigerator compartment shelves are adjustable so you can locate them according to your needs.

- **Slide Shelf**
Pull the shelf ahead and take off it while lifting both front and rear part.

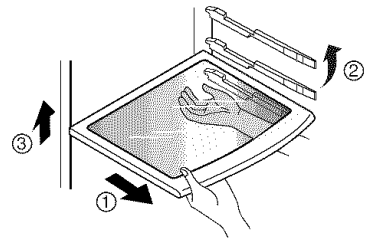

- **Fixed Shelf, Folding Shelf**
Lightly lift up the front part of shelf to pull it ahead and then take off it while lifting the rear part of shelf.

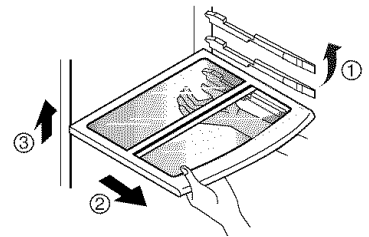

NOTE

- Make sure the shelf is horizontal. If not, it may drop.

Slide-Under Shelf

You can store taller items such as a gallon container or bottles by simply pushing in front half of shelf underneath back half of shelf. Pull toward you to return to a full shelf.

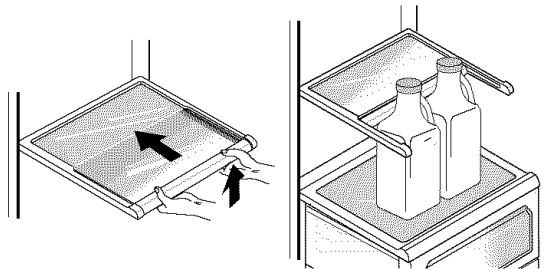

Humidity control in the vegetable compartment

The humidity can be controlled by adjusting the humidity control switch to the left when storing vegetables or fruits.

High humidity

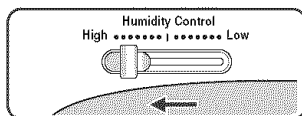

Low humidity

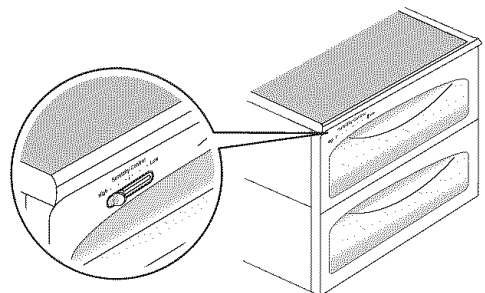
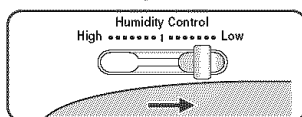

OptiFresh temperature bin

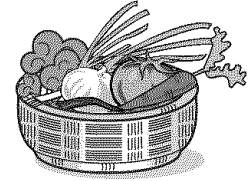

Method to use

You can select the optimum temperature to store some types of foods.

- Vegetables, fruits, cold storage items requiring humidity maintenance can be stored under optimal condition by pressing the button.

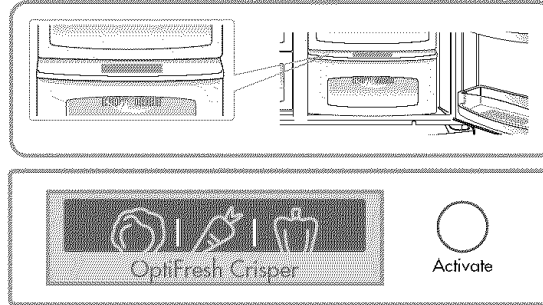

- If you open the refrigerator door, an indicator lamp shows the status of the OptiFresh. The lamp goes off when the door is closed.
- Press the button to cycle between ON and OFF.

OptiFresh

When removing OptiFresh

- First, remove the vegetable bin.
- After holding both ends of the OptiFresh ① and ② pull it outward.

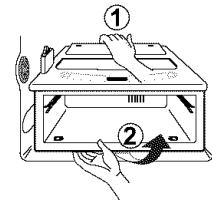

When installing OptiFresh

- Fit the OptiFresh case on to the ledge ① and gently slide it in ②.
- If forced, the connecting parts can be damaged.

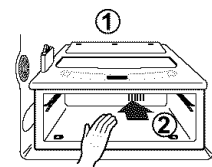

Location of foods

(Refer to Identification of Parts, page 4.)

- Snack drawer** Store small foods such as bread, snacks, etc.

- Freezer compartment shelf** Store various frozen foods such as meat, fish, ice cream, frozen snacks, etc.

- Freezer compartment door rack** Store small packed frozen food. Items stored in the door racks don't stay quite as cold as in the rest of the freezer. Store ice cream and similar items on a shelf in the freezer instead.

- Freezer compartment drawer** Store meat, fish, chicken, etc. after wrapping them with thin foil. Store dry.

- Milk product corner** Store milk products such as butter, cheese, etc.

- Refreshment center** Store foods of frequent use such as beverages, etc.

- Refrigerator compartment shelf** Do not pack the freezer or refrigerator tightly. Allow a little room for proper air circulation to aid cooling.

- Refrigerator compartment door rack** Store small packed food or beverages such as milk, juice, etc.

- Vegetable drawer** Store vegetables or fruits.

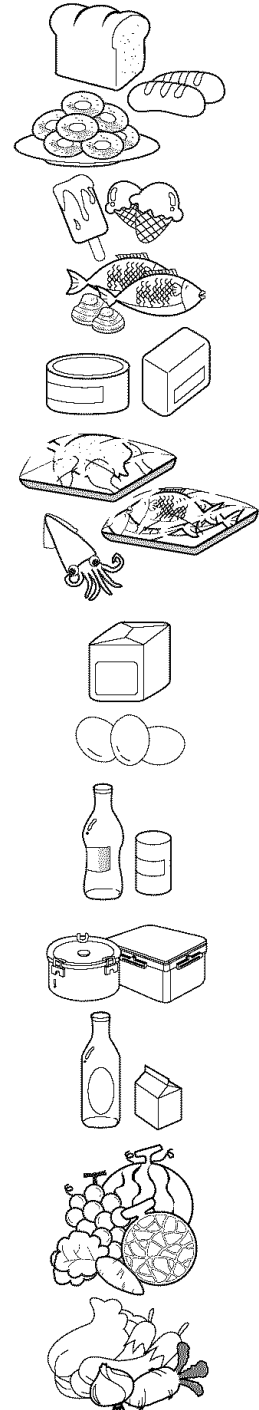

Storing foods

- Store fresh food in the refrigerator compartment. How food is frozen and thawed is an important factor in maintaining its freshness and flavor.
- Do not store food which spoils easily at low temperatures, such as bananas and melons.
- Allow hot food to cool prior to storing, placing hot food in the refrigerator could spoil other food, and lead to higher energy consumption.
- When storing the food, cover it with vinyl wrap or store in a container with a lid. This prevents moisture from evaporating, and helps food to keep its flavor and nutrition.
- Do not block air vents with food. Smooth circulation of chilled air keeps refrigerator temperatures even.
- Do not open the door frequently. Opening the door lets warm air enter the refrigerator, and cause temperatures to rise.
- Never overload the door racks because they may push against by inner racks so that the door cannot be fully closed.

Freezer compartment

- Do not store bottles in the freezer compartment, they may break when frozen.
- Do not refreeze food that has been thawed. This causes loss of flavor and nutrition.
- When storing frozen food like ice cream for a long period, place it on the freezer shelf, not in the door rack.
- Do not touch the cold foods or containers, especially made of metal, with wet hands and place glass products in the freezer compartment.
 - Damp skin can freeze and stick to cold surfaces, causing frostbite and other serious injuries.

Refrigerator compartment

- Avoid placing moist food in top refrigerator shelves, it could freeze from direct contact with chilled air.
- Always clean food prior to refrigeration. Vegetables and fruits should be washed and wiped, and packed food should be wiped, to prevent adjacent food from spoiling.
- When storing eggs in their storage rack or box, ensure that they are fresh, and always store them in an upright position to keep them fresh longer.

NOTE

- If you keep the refrigerator in a hot and humid place, frequent opening of the door or storing a lot of vegetables in it may cause condensation to form. Wipe the condensation with a clean cloth or a paper towel.

How to remove and replace parts

NOTE

- Dismantling is done in the reverse sequence of assembly.
Be sure to unplug the power plug before dismantling and assembly.
Never apply severe force to dismantle parts. Parts may be damaged.

Freezer compartment lamp

To remove the lamp cover, separate the shelf over the lamp cover and pull the lamp cover forwards ② while pressing the bottom side of the lamp cover upwards ①. Turn the bulb counterclockwise.
Use a 40-watt bulb (max.) which can be purchased at a service center.

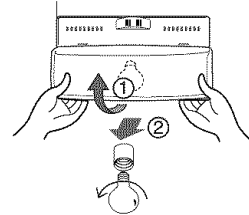

Freezer compartment shelf

To remove a shelf, push the shelf to the left ①, lift the left part of the shelf a bit ②, lift the right part up ③, and take it out.

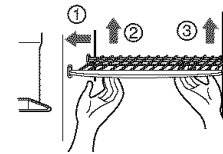

Door rack and support

Lift the door rack holding both sides ① and pull it out ②.

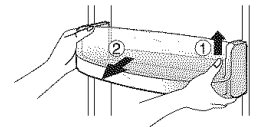

Ice storage bin

Hold the ice storage bin as shown in the right figure and pull it out ② while slightly lifting it ①.

- Do not dismantle the ice storage bin unless it is necessary.
- Use both hands to remove the ice bin to avoid dropping it.

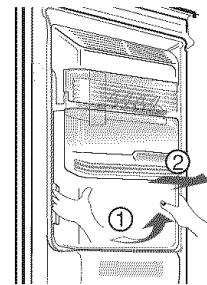

After dispenser is used

The water collector has no self-draining function. It should be cleaned regularly. Remove the cover by pulling the front side of water collector cover and dry it with a cloth.

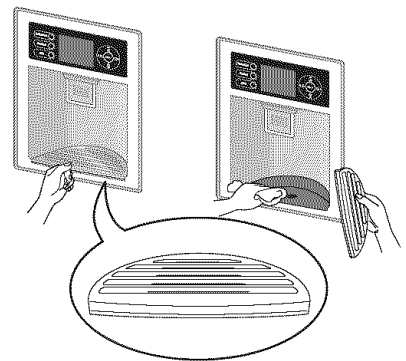

Upper lamp in refrigerator compartment

To remove the lamp cover, pull the lamp cover forward while pressing the bottom side of the lamp cover upward. Turn the bulb counterclockwise.

Use a 40-watt bulb (max.) which can be purchased at a service center.

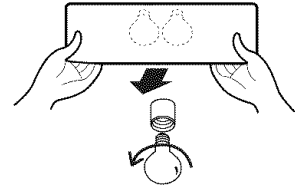

Lower lamp in refrigerator compartment

Separate the lamp cover by holding both lower sides of it and pulling it forward. Turn the bulb counterclockwise.

Use a 40-watt bulb (max.) which can be purchased at a service center.

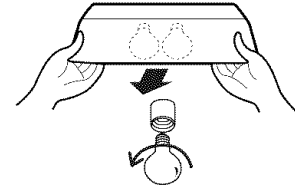

NOTE

- Be sure to remove the necessary door racks and other parts to allow clearance to remove the vegetable compartment, snack, drawer, and home bar cover.

Vegetable compartment cover

- To remove the vegetable compartment cover, pull out the vegetable compartment a bit to the front ①, lift the front part of the vegetable compartment cover as shown by ②, and take it out.

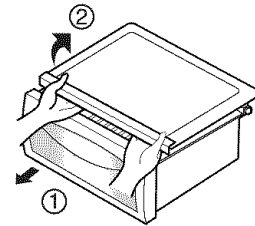

Filter replacement

We recommend replacing the filter when the water filter indicator light turns on or your water dispenser or ice maker decreases noticeably. After changing the water filter cartridge, reset the water filter status display and indicator light by pressing and holding the **BUTTON** for 3 seconds.

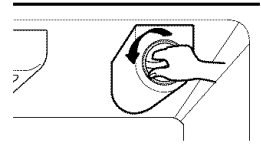

- 1) Remove the old cartridge.
Rotate the knob of the cartridge counter clockwise. When the cartridge is removed, you will feel it click out of place.
Pull out the cartridge.

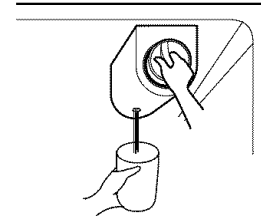

NOTE

- Replacing filter causes small amount of water (around 1 oz or 25 cc) to flow out. Please put up a cup under the hole to prevent it.

- 2) Replace with a new cartridge.
Take the new cartridge out of its packaging and remove protective cover from the o-rings. With cartridge knob in the vertical position, push the new filter cartridge into the cover until it stops.
If you can't turn the filter from side to side, it isn't fully inserted. Push it in firmly and twist it into place. You will hear the snap when it clicks into place. Using its handle, twist the cartridge clockwise about 1/4 turn. You will hear the snap when it clicks into place.

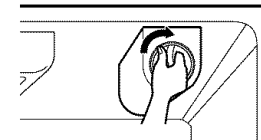
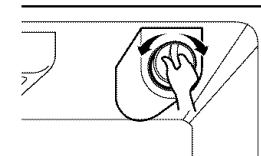

- 3) Flushing the Water System After Replacing Filter.
Dispense water through the water dispenser for 3 minutes to purge the system.

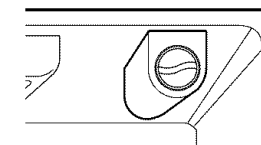

General information

Vacation time	<p>During average length vacations, you will probably find it best to leave the refrigerator in operation. Place freezable items in freezer for longer life.</p> <p>When you plan to store the refrigerator, remove all food, disconnect the power cord, clean the interior thoroughly, and block the doors open to prevent mold and mildew. Be certain the stored refrigerator does not present a child entrapment danger.</p>
Power failure	<p>Most power failures that are corrected in an hour or two will not affect your refrigerator temperatures. However, you should minimize the number of door openings while the power is off.</p>
If you move	<p>Unload the refrigerator to relocate it. (This is probably not necessary to pull it out for cleaning behind it.) Be sure to let the refrigerator warm up to room temperature, and dry the inside before closing the doors to pack it for moving.</p> <p>To avoid damaging the height adjusting screws, turn them all the way into the base.</p>
Anti-condensation pipe	<p>The outside wall of the refrigerator cabinet may sometimes get warm, especially just after installation. Don't be alarmed. This is due to the anti-condensation pipe, which pumps hot refrigerant to prevent sweating on the outer cabinet wall.</p>
Demo mode setting	<p>After setting the Lock function press the Temperature button and ◀ button simultaneously for 5 seconds.</p> <p>When entering the Demo mode, you will see the letters DEMO on the top left side of the screen with a ding sound.</p> <p>When canceling the Demo mode, do it as the same procedure as the Lock setup and press the Temperature and ◀ button simultaneously for 5 seconds.</p> <p>With a ding sound, you will see the letters DEMO disappear on the top left side of the screen and the Demo mode will be canceled.</p> <p>(Demo mode : Demo mode is available for displaying the refrigerator in sales setting or similar condition. It allows the display, dispenser, light, and fan to operate without running the compressor. When it set the demonstrations mode, the cooling air doesn't come out from refrigerator.)</p>

Cleaning

It is important that your refrigerator be kept clean to prevent undesirable odors. Spilled food should be wiped up immediately, since it may acidify and stain plastic surfaces if allowed to settle.

Exterior	<p>aUse a lukewarm solution of mild soap or detergent to clean the durable finish of your refrigerator. Wipe with a clean damp cloth and then dry.</p>
Interior	<p>Regular cleaning is recommended. Wash all compartments with a baking soda solution or a mild detergent and warm water. Rinse and dry. Be sure to allow the soda to dissolve completely so it will not act as an abrasive compound.</p>
After cleaning	<p>Please verify that the power cord is not damaged, power plug is not overheated, or power plug is well inserted into the power consent.</p>
Warning	<p>Always remove the power cord from the wall outlet prior to cleaning in the vicinity of electrical parts (lamps, switches, controls, etc.).</p> <p>Wipe up excess moisture with a sponge or cloth to prevent water or liquid from getting into any electrical part and causing an electric shock.</p> <p>Never use metallic scouring pads, brushes, coarse abrasive cleaners, strong alkaline solutions, or flammable or toxic cleaning liquids on any surface.</p> <p>Do not touch frozen surfaces with wet or damp hands, because damp objects will stick to extremely cold surfaces.</p>

Troubleshooting

Before calling for service, review this list. It may save you both time and expense. This list includes common occurrences that are not the result of defective workmanship or materials in this appliance.

Occurrence	Possible Cause	Solution
Normal Operations Refrigerator		
Refrigerator compressor does not run.	Refrigerator control is off.	Set refrigerator control.
	Refrigerator is in defrost cycle.	This is normal for a fully automatic defrosting refrigerator. The defrost cycle occurs periodically.
	Plug at wall outlet is disconnected.	Make sure plug is tightly pushed into outlet.
	Power outage. Check house lights.	Call local electric company.
Refrigerator runs too much or too long	Refrigerator is larger than the previous one you owned.	This is normal. Larger, more efficient units run longer.
	Room or outside weather is hot.	It is normal for the refrigerator to work longer under these conditions.
	Refrigerator has recently been disconnected for a period of time.	It takes a few hours for the refrigerator to come down to room temperature completely.
	Automatic icemaker is operating.	Operation of the ice maker causes the refrigerator to run slightly longer.
	Large amounts of warm or hot food may have been stored recently.	Warm food will cause the refrigerator to run longer until the desired temperature is reached.
	Doors are opened too frequently or too long.	Warm air entering the refrigerator causes it to run more. Open the door less often.
	Refrigerator or freezer door may be slightly open.	Make sure the refrigerator is level. Keep food and containers from blocking the door. See problem section OPENING/CLOSING of doors, page 11.
	Refrigerator control is set too cold.	Adjust the refrigerator control to a warmer setting until the refrigerator temperature is satisfactory.
	Refrigerator or freezer gasket is dirty, worn, cracked, or poorly fitted.	Clean or change gasket. Leaks in the door seal will cause the refrigerator to run longer in order to maintain desired temperatures.

Occurrence	Possible Cause	Solution
Refrigerator compressor does not run.	Thermostat is keeping the refrigerator at a constant temperature.	This is normal. The Refrigerator goes on and off to keep the temperature constant.
Temperatures are too cold		
Temperature in the freezer is too cold but the Refrigerator Temperature is Satisfactory.	Freezer control is set too cold	Adjust the freezer control to a warmer setting until the freezer temperature is satisfactory.
Temperature in the refrigerator is too cold and the freezer temperature is satisfactory.	Refrigerator control is set too cold.	Adjust the refrigerator control to a warmer setting
Food stored in drawers freezes.	Refrigerator control is set too cold.	Adjust the refrigerator to a warmer setting.
Meat stored in fresh meat drawer freezes.	Meat should be stored at a temperature just below the freezing point of water (32°F, 0°C) for maximum fresh storage time.	It is normal for ice crystals to form due to the moisture content of meat.
Temperatures are too warm		
Temperatures in the refrigerator or freezer are too warm.	Freezer control is set too warm.	Adjust the freezer or refrigerator control to a colder setting until the freezer or refrigerator temperature is satisfactory.
	Refrigerator control is set too warm. Refrigerator control has some effect on freezer temperature.	Adjust the freezer or refrigerator control to a colder setting until the freezer or refrigerator temperature is satisfactory.
	Doors are opened too frequently or too long.	Warm air enters the refrigerator/ freezer whenever the door is opened. Open the door less often.
	Door is slightly open.	Close the door completely.
	Large amounts of warm or hot food may have been stored recently.	Wait until the refrigerator or freezer has had a chance to reach its selected temperature.
	Refrigerator has recently been disconnected for a period of time.	A refrigerator requires several hours to cool down completely.
Temperature in the refrigerator is too warm but the freezer temperature is satisfactory.	Refrigerator control is set too warm.	Adjust the refrigerator control to a colder setting.

Occurrence	Possible Cause	Solution
Sound and Noise		
Louder sound levels when Refrigerator is on.	Today's refrigerators have increased storage capacity and maintain more even temperatures.	It is normal for sound levels to be higher.
Louder sound levels when compressor comes on.	Refrigerator operates at higher pressures during the start of the ON cycle.	This is normal. The sound will level off as the refrigerator continues to run.
Vibrating or rattling noise.	Floor is uneven or weak. Refrigerator rocks on the floor when it is moved slightly.	Be sure floor is level and solid and can adequately support refrigerator.
	Items placed on the top of the refrigerator are vibrating.	Remove items.
	Dishes are vibrating on the shelves in the refrigerator.	It is normal for dishes to vibrate slightly. Move dishes slightly. Make sure refrigerator is level and firmly set on floor.
	Refrigerator is touching wall or cabinets.	Move refrigerator so that it does not touch the wall or refrigerator.
Water/Moisture /Ice Inside Refrigerator		
Moisture collects on the inside walls of the refrigerator.	The weather is hot and humid which increases the rate of frost buildup and internal sweating.	This is normal.
	Door is slightly open.	See problem section Opening/Closing of doors, page 11.
	Door is opened too often or too long.	Open the door less often.
Water/Moisture/Ice Outside Refrigerator		
Moisture forms on the outside of the refrigerator or between doors.	Weather is humid.	This is normal in humid weather. When humidity is lower, the moisture should disappear.
	Door is slightly open, causing cold air from the inside the refrigerator to meet warm air from the outside.	Close the door completely.
Moisture forms on the dispenser or refreshment center	Moisture may be formed in high temperature and high humidity since heater turns off if not opening the doors for a long time.	Wipe the moisture and open the doors again.

Occurrence	Possible Cause	Solution	
Odors in Refrigerator	Interior needs to be cleaned.	Clean interior with sponge, warm water, and baking soda. Be sure the soda is completely dissolved so it will not act as an abrasive compound.	
	Food with strong odor is in the refrigerator.	Cover food completely.	
	Some containers and wrapping materials produce odors.	Use a different container or brand of wrapping materials.	
Opening/Closing of Doors/Drawers			
	Door(s) will not close.	Food package is keeping door open.	Move packages that keep door from closing.
	Door(s) will not close.	Door was closed too hard, causing other door to open slightly.	Close both doors gently.
		Refrigerator is not level. It rocks on the floor when it is moved slightly.	Adjust the height adjusting screw.
		Floor is uneven or weak. Refrigerator rocks on the floor when it is moved slightly.	Be sure floor is level and can adequately support refrigerator. Contact carpenter to correct sagging or sloping floor.
	Refrigerator is touching wall or cabinets.	Move refrigerator.	
Drawers are difficult to move.	Food is touching shelf on top of the drawer	Keep less food in drawer.	
	Track that drawer slides on is dirty.	Clean drawer and track.	
Dispenser			
Dispenser will not dispense ice	Ice storage bin is empty.	When the first supply of ice is dropped into the bin, the dispenser should operate.	
	Freezer temperature is set too warm.	Turn the freezer control to a higher setting so that ice cubes will be made. When the first supply of ice is made, the dispenser should operate.	
	Household water line valve is not open.	Open household water line valve and allow sufficient time for ice to be made. When ice is made, dispenser should operate.	
	Refrigerator or freezer door is not closed.	Be sure both doors are closed.	

Occurrence	Possible Cause	Solution
Dispenser will not dispense ice.	Ice has melted and frozen around auger due to infrequent use, temperature fluctuations, and/or power outages.	Remove ice storage bin, and thaw and the contents. Clean bin, wipe dry, and replace in proper position. When new ice is made, dispenser should operate.
Ice dispenser is jammed.	Ice cubes are jammed between the ice maker arm and back of the bin.	Remove the ice cubes that are jamming the dispenser.
	Ice cubes are frozen together.	Use the dispenser often so that cubes do not freeze together.
	Ice cubes that have been purchased or made in some other way have been used in the dispenser.	Only the ice cubes made by the ice maker should be used with the dispenser.
Dispenser will not dispense water.	Household water line valve is not open.	Open household water line valve.
	Refrigerator or freezer door is not closed.	Be sure both doors are closed.
Water has an odd taste and/or odor.	Water has been in the tank for too long.	Draw and discard 7 glasses of water to freshen the supply. Draw and discard an additional 7 glasses to completely rinse out tank.
	Unit not properly connected to cold water line.	Connect unit to cold water line which supplies water to kitchen faucet.
Sound of ice dropping	This sound is normally made when automatically made ice is dropped into ice storage bin. Volume may vary according to refrigerator's location.	
Sound of water supply	This sound is normally made when ice maker is supplied with water after dropping the automatically made ice.	
Other	Please thoroughly read Automatic Icemaker and Dispenser in this manual on pages 15.	
Weather Forecast		
Function is not operate	Reception of weather forecast information received and displayed on the screen is subject to vary depending on your region and location of refrigerator. Check your zip code in this manual pages 151 or www.ambientdevices.com/cat/device/coverage.html	

CUSTOMER ASSISTANCE NUMBERS:<http://www.lgservice.com>

- To Prove Warranty Coverage
Retain your sales receipt to prove date of purchase.
A copy of your sales receipt must be submitted at the time warranty service is provided.
- To Obtain Product, Customer, or Service Assistance
Call Toll-free for Customer Service
Tel : 1-800-243-0000
- To Obtain Nearest Authorized Service Center
Call 1-800-243-0000, push option #1, 24 hours a day, 7 days per week.
Please have your product type (Refrigerator), model number, serial number, and postcode ready.

LG ELECTRONICS, INC.
LG REFRIGERATOR LIMITED WARRANTY - USA



Your LG Refrigerator will be repaired or replaced, at LG's option, if it proves to be defective in material or workmanship under normal use, during the warranty period (Warranty Period) set forth below, effective from the date ("Date of Purchase") of original consumer purchase of the product. This warranty is good only to the original purchaser of the product and effective only when used in the United States, including Alaska, Hawaii, and U.S. Territories.

WARRANTY PERIOD:	HOW SERVICE IS HANDLED:
REFRIGERATOR/FREEZER LABOR: One Year from the Date of Purchase. PARTS: One Year from the Date of Purchase. SEALED SYSTEM (Compressor, Condenser, and Evaporator) LABOR: One Year from the Date of Purchase. PARTS: Seven years from the Date of Purchase. Replacement Units and Repair Parts are warranted for the remaining portion of the original unit's warranty period.	In-Home Service (Except Model GR051): Please retain dealer's dated bill of sale or delivery ticket as evidence of the Date of Purchase for proof of warranty, and submit a copy of the bill of sale to the service person at the time warranty service is provided. Please call 1-800-243-0000 and choose the appropriate option to locate your nearest LG Authorized Service Center. (Phones are answered 24 hours a day, 365 days per year.) Or visit our website at: http://www.lgservice.com

THIS WARRANTY IS IN LIEU OF ANY OTHER WARRANTY, EXPRESS OR IMPLIED, INCLUDING WITHOUT LIMITATION, ANY WARRANTY OF MERCHANTABILITY OR FITNESS FOR A PARTICULAR PURPOSE. TO THE EXTENT ANY IMPLIED WARRANTY IS REQUIRED BY LAW, IT IS LIMITED IN DURATION TO THE EXPRESS WARRANTY PERIOD ABOVE. NEITHER THE MANUFACTURER NOR ITS U.S. DISTRIBUTOR SHALL BE LIABLE FOR ANY INCIDENTAL, CONSEQUENTIAL, INDIRECT, SPECIAL, OR PUNITIVE DAMAGES OF ANY NATURE, INCLUDING WITHOUT LIMITATION, LOST REVENUES OR PROFITS, OR ANY OTHER DAMAGE WHETHER BASED IN CONTRACT, TORT, OR OTHERWISE. Some states do not allow the exclusion or limitation of incidental or consequential damages or limitations on how long an implied warranty lasts, so the above exclusion or limitation may not apply to you. This warranty gives you specific legal rights and you may also have other rights that vary from state to state.

Reception of weather forecast information received and displayed on the screen is subject to vary depending on your region and location of refrigerator. Thereby LG does not guarantee and will not be held responsible for accuracy of the weather information. Weather forecast information is only available in U.S.A

THIS LIMITED WARRANTY DOES NOT APPLY TO:

- Service trips to your home to deliver, pick up, and/or install the product, instruct, or replace house fuses or correct wiring, or correction of unauthorized repairs.
- Damages or operating problems that result from misuse, abuse, operation outside environmental specifications or contrary to the requirements of precautions in the Operating Guide, accident, vermin, fire, flood, improper installation, acts of God, unauthorized modification or alteration, incorrect electrical current or voltage, or commercial use, or use for other than intended purpose.
- Repairs when your LG refrigerator is used in other than normal, single-family household use.

The cost of repair or replacement under these excluded circumstances shall be borne by the consumer.

CUSTOMER INTERACTIVE CENTER NUMBERS

To obtain Customer Assistance, Product Information, or Dealer or Authorized Service Center location:	Call 1-800-243-0000 (24 hours a day, 365 days per year) and select the appropriate option from the menu. Or visit our website at: http://www.lgservice.com
---	--

TO CONTACT LG ELECTRONICS BY MAIL:

LG Customer Interactive Center
P. O. Box 240007
201 James Record Road
Huntsville, Alabama 35824
ATTN: CIC



LG Electronics Inc.

LG Twin Tower, 20, Yoido-Dong,
Youngdungpo-Gu, Seoul, 150-721, Korea.
<http://www.lge.com>