

HOOVER®

Canister Cleaner

Owner's Manual

ENGLISH → pp. 1-9

ESPAÑOL → pág. 10-14

FRANÇAIS → p.15-19

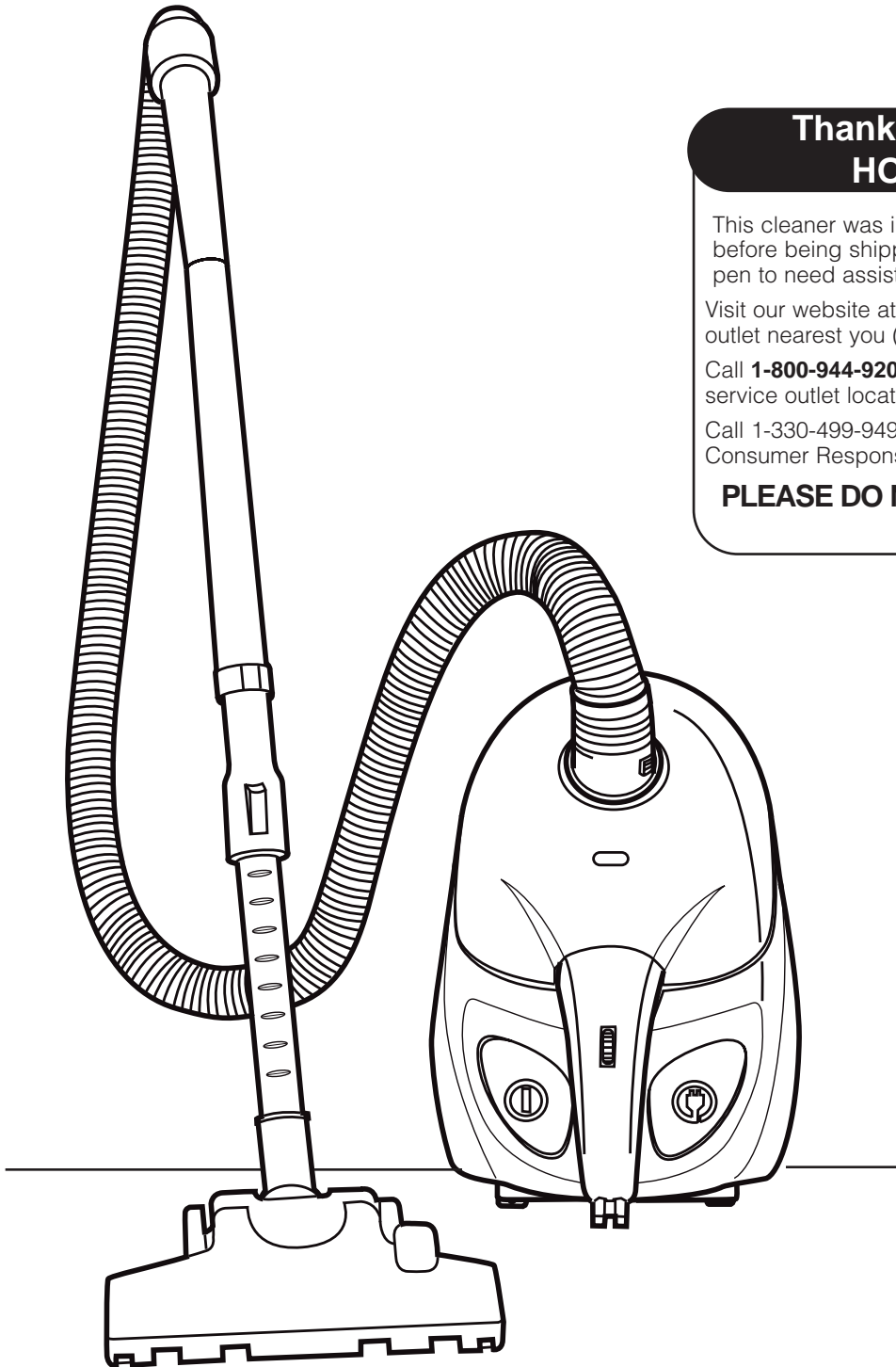

Thank you for selecting a HOOVER® product

This cleaner was inspected and packaged carefully before being shipped from the factory. If you should happen to need assistance during assembly or operation,

Visit our website at www.hoover.com to find the service outlet nearest you (click on the "Service") button OR

Call **1-800-944-9200** for automated referral of authorized service outlet locations (U.S. only) OR

Call 1-330-499-9499 to speak with a representative in our Consumer Response Center.

**PLEASE DO NOT RETURN THIS PRODUCT
TO THE STORE.**

**Review this manual before
operating cleaner**



www.hoover.com

Fill in and retain

The model and serial number are located on the bottom of the cleaner.

For your personal records, please enter the COMPLETE model and serial number in the spaces provided and retain this information.

Your cleaner is model _____

and has serial number _____

It is suggested that you attach your sales receipt to this owner's manual. Verification of date of purchase may be required for warranty service of your Hoover product.

Index

Assembling Cleaner	3
How To Use	
Canister Cleaner	4-5
Cleaner Descriptions	4
Cleaning Stairs	5
Cleaning Tools	5
Rug and Floor Nozzle	4
If You Have a Problem	8
Clearing Blockages	8
Important Safeguards	2
Maintenance	
Filter Bag	6
Lubrication	7
Filters	7
Service	7
Thermal Protector	7
Warranty	8



Important Safeguards

When using an electrical appliance, always follow basic precautions, including the following:

READ ALL INSTRUCTIONS BEFORE USING THIS APPLIANCE

Warning:

To reduce the risk of fire, electric shock or injury:

- Do not use outdoors or on wet surfaces.
- Close supervision is necessary when any appliance is used by or near children. Do not allow vacuum cleaner to be used as a toy or to run unattended at any time.
- Keep hair, loose clothing, fingers, and all parts of body away from openings and other moving parts.
- Do not pick up anything that is burning or smoking, such as cigarettes, matches, or hot ashes.
- Do not use to pick up flammable or combustible liquids such as gasoline or fine wood sandings or use in areas where they may be present.
- Avoid picking up hard, sharp objects with the cleaner. They may damage the cleaner and the bag.
- Do not use without dust bag or filters in place. Change bag frequently when picking up very fine materials such as powder.
- Use extra care when cleaning on stairs.
- Do not put any object into openings. Do not use with any opening blocked; keep free of dust, lint, hair, or anything that may reduce air flow.
- Do not pull or carry by cord, use cord as a handle, close door on cord or pull cord around sharp edges or corners. Do not run appliance over cord. Keep cord away from heated surfaces.
- Always disconnect cord from electrical outlet before servicing the cleaner.
- Unplug cleaner when not in use. Turn off all controls before unplugging.
- Do not unplug by pulling on cord. To unplug, grasp the plug, not the cord. Never handle plug or appliance with wet hands.
- If cleaner has a cord reel, hold onto the plug while cord is being rewound to prevent cord from whipping.
- The use of an extension cord is not recommended.
- Do not use with damaged cord or plug. If appliance is not working as it should, has been dropped, damaged, left outdoors, or dropped into water, take it to a Hoover Factory Service Center or Authorized Hoover Warranty Service Dealer (Depot).
- Use vacuum cleaner only for its intended use as described in the instructions. Use only attachments recommended by The Hoover Company; others may cause hazards.

Save these instructions!

Questions or Concerns?

This cleaner was inspected and packaged carefully before being shipped from the factory. If you should happen to need assistance during assembly or operation,

Visit us online at www.hoover.com to find the service outlet nearest you (click on the "Service" button) OR Call **1-800-944-9200** for an automated referral of authorized service outlet locations (U.S. only) OR Call 1-330-499-9499 to speak with a representative in the Hoover Consumer Response Center.

PLEASE DO NOT RETURN THIS PRODUCT TO THE STORE.

1. Assembling cleaner

Carton contents

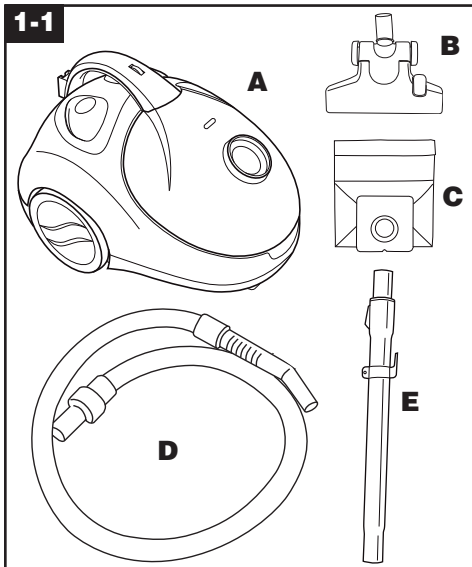

Unpack cleaner from carton and identify the parts shown. Remove and dispose of packing.

- A. Canister cleaner
- B. Rug and floor nozzle
- C. Extra filter paper bag (one bag is installed in cleaner)
- D. Hose
- E. Telescopic wand

Connecting hose, wand and nozzle

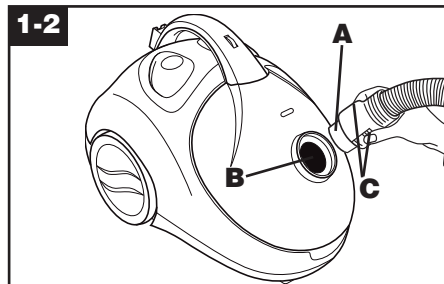

Connect hose

Push hose connector (A) into opening (B) in bag lid. To disconnect hose, depress buttons (C) on hose connector and pull up.

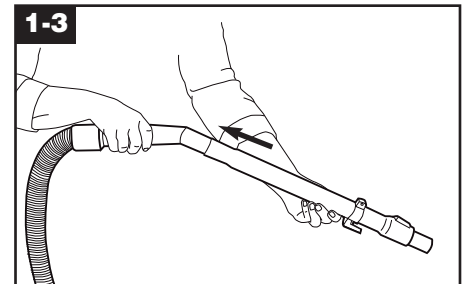

Attach wand, tools and nozzle

To attach wand to hose, push wand firmly onto hose; twist wand to tighten.

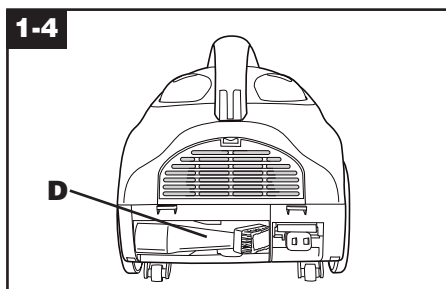

The combination dusting brush/crevice tool (D) is stored on the back of the cleaner.

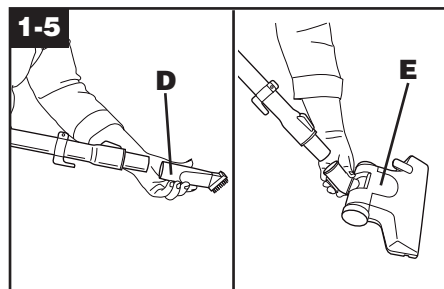

To attach tool (D) to the hose or the wand, push tool firmly onto hose. Twist tool slightly to tighten or loosen connection. To attach the nozzle (E) to the wand, push the nozzle firmly onto the wand.

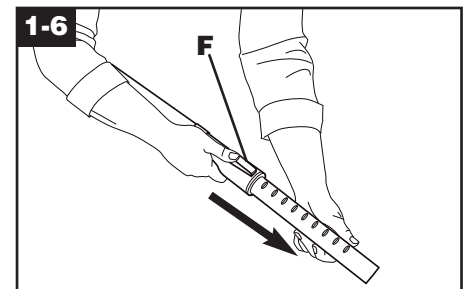

To adjust the telescoping wand, push spring latch (F) forward and pull down on lower portion of wand. Adjust wand to desired length. Release latch to lock the wand in position.

2. How to use

Cleaner description

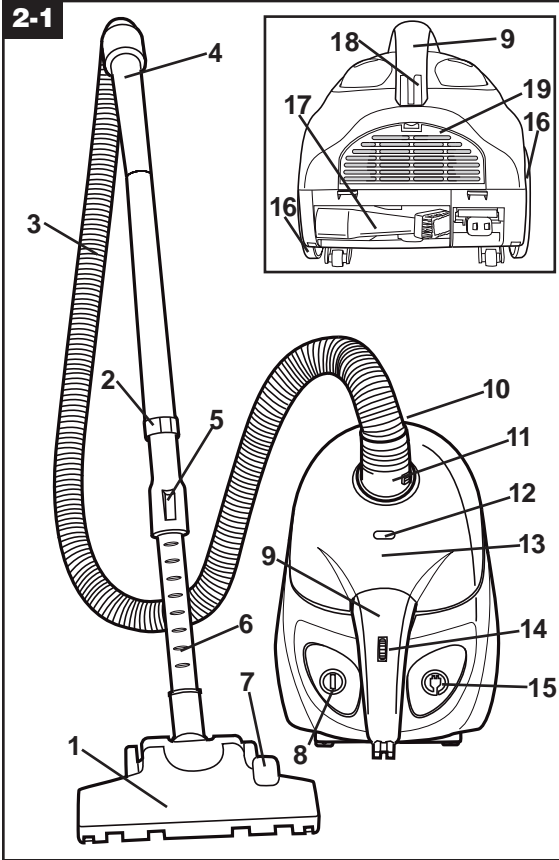

The assembled cleaner will look like the drawing.

1. Rug and floor nozzle
2. Wand storage clip: fits into storage slots on rear and under-side of canister.
3. Lightweight hose
4. Hand grip
5. Spring latch
6. Telescoping extension wand: used with rug and floor nozzle or tools. Adjusts to desired length.
7. Carpet/bare floor selector
8. ON/OFF pedal
9. Carrying handle
10. Bag lid latch: lift to open bag lid.
11. Hose connector
12. Check bag indicator: turns from blue to red when paper bag should be checked for fullness.
13. Bag lid
14. Variable speed control

15. Cord rewind pedal: step on pedal to rewind cord for storage.
Hold plug until cord is rewound.

16. Large wheels: provide easy towing when cleaner is pulled over carpet, area rugs and door sills.

17. Dusting brush/crevice tool

18. Wand storage slot

19. Final filter door

This cleaner is intended for household use.

Operate cleaner only at voltage specified on data plate on bottom of cleaner.

Polarized plug

To reduce the risk of electric shock, this appliance has a polarized plug (one blade is wider than the other). This plug will fit in a polarized outlet only one way. If the plug does not fit fully in the outlet, reverse the plug. If it still does not fit, contact a qualified electrician to install the proper outlet. Do not change the plug in any way.

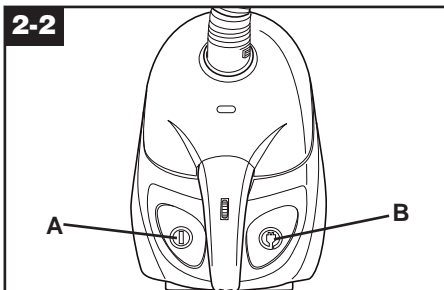

ON-OFF pedal

Depress ON-OFF pedal (A) to turn cleaner ON or OFF.

NOTE: Pedal opposite ON-OFF pedal is the cord rewind pedal (B).

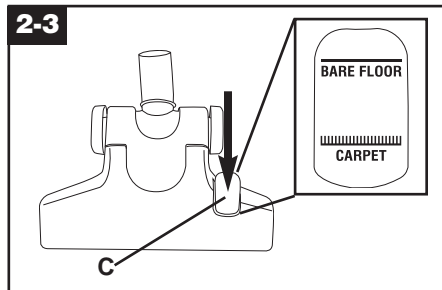

Rug and floor nozzle

The combination rug and floor nozzle has been designed to do an efficient cleaning job on both carpet and hard surface floors.

The nozzle has a BARE FLOOR setting and a CARPET setting. To change from one setting to the other, step on the pedal (C) located on top of the nozzle.

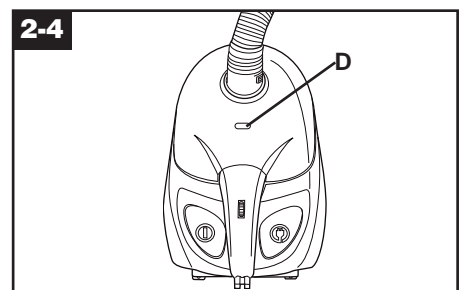

Check bag indicator

The indicator (D) will begin to show red as bag fills with dirt. When the indicator is about 2/3 red, the bag should be changed.

Listed below are three conditions that will cause the indicator to become completely red. Suggested solutions are provided.

1. The bag is full; change the bag.
2. Very fine materials (such as powder) have been picked up, clogging the bag pores; change the bag, even if it is not full.
3. There is a blockage in the nozzle, hose, tools or at the bag opening; remove the blockage.

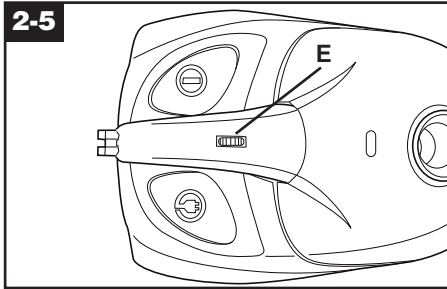

Variable speed control

The variable speed control (E) is located on top of the cleaner. Roll the control toward **—** to reduce energy consumption and to clean lightly soiled areas or delicate fabrics.

Roll the control toward **+** for maximum cleaning power in heavily soiled areas.

If the floor nozzle is difficult to push, roll the control toward **—**.

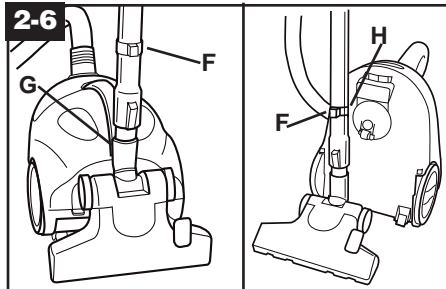

Wand storage clip

The wand storage clip (F) fits into the slot (G) at the rear of the cleaner or the slot (H) on the bottom of the cleaner.

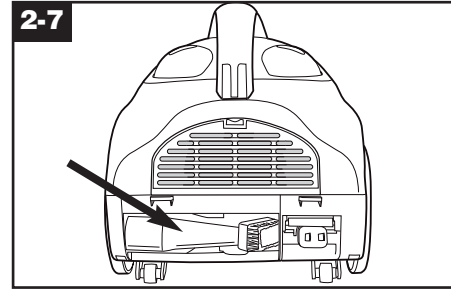

Cleaning tools

Tool storage

The combination dusting brush/crevice tool is stored on the back of the cleaner.

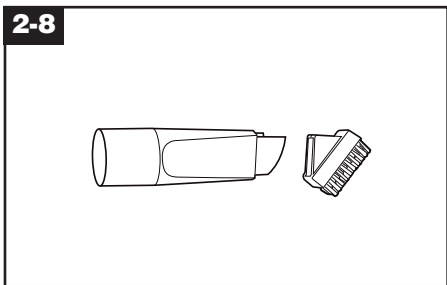

The dusting brush/crevice tool

may be used for carved furniture, table tops, books, lamps, lighting fixtures, venetian blinds, baseboards, shutters and registers. Remove the brush and use the crevice tool in tight spaces, corners and along edges in such places as dresser drawers, upholstered furniture, stairs and baseboards.

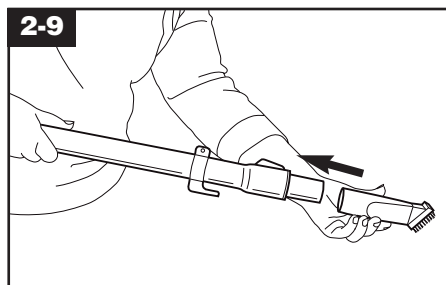

Attaching tools

The tool and the floor nozzle are attached to the hose or the wand in the same manner. Push tool firmly onto hose; twist tool slightly to tighten or loosen connection.

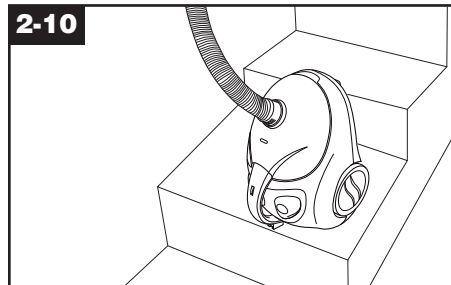

Cleaning stairs

Clean stairs by placing cleaner on end as shown. Clean stairs from bottom to top.

3. Maintenance

Familiarize yourself with these home maintenance tasks as proper use and care of your cleaner will ensure continued cleaning effectiveness.

Filter bag

When to replace

Check bag from time to time. Check bag when indicator becomes about 2/3 red. When bag is filled with dirt, the cleaner will not operate efficiently. Discard used bag.

CAUTION: Very fine materials, such as face powder, or cornstarch, may seal the paper bag and may cause it to burst even though it is only partially full of dirt. When the cleaner is used to remove material of this nature, change the bag often.

What bags to buy

It is important to use only **Genuine HOOVER® Type R30** disposable bags in order to **maintain the original cleaning effectiveness of your cleaner.**

To assure that your HOOVER cleaner operates at peak performance, it is imperative that you use only genuine HOOVER paper bags. HOOVER bags can be identified by these trademarks —



Where to buy bags

Bags may be purchased from your local Authorized Hoover Dealers (Depots), Leading Retailers, Hoover Factory Service Centers, or through The Hoover Company online at www.hoover.com.

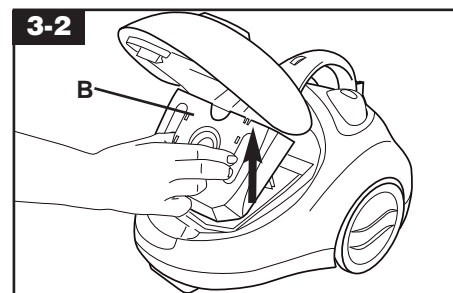
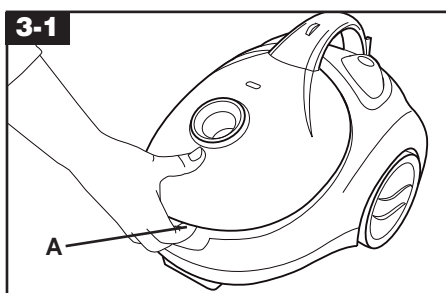

Replacing the filter bag

Disconnect cleaner from electrical outlet.

Press bag lid latch (A) and open bag lid.

Lift out bag holder (B) and bag.

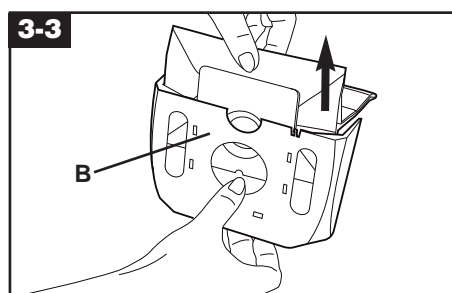

Slide used bag out of bag holder (B). Discard used bag.

Note: Do not discard bag holder (B) with used bag.

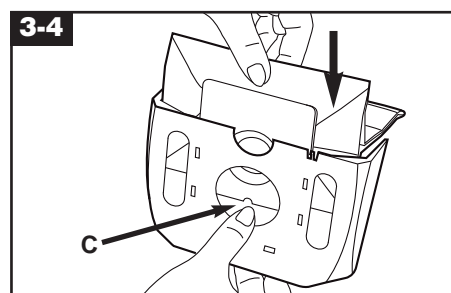

Slide new bag into holder. Make sure notch on bag collar (C) is facing down.

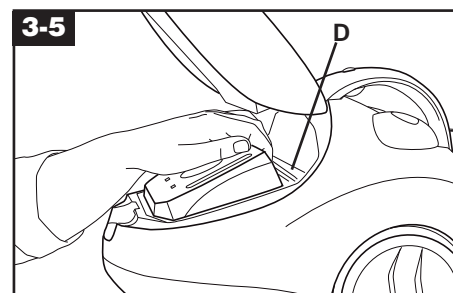

Place bag holder and new bag into bag compartment, making sure bag is below seal (D).

Close bag lid.

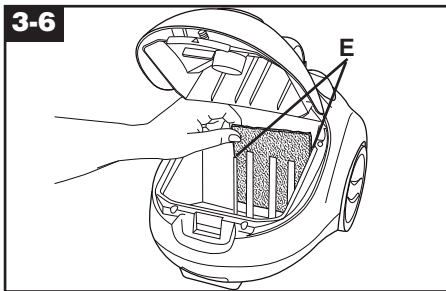

Secondary filter

Disconnect cleaner from electrical outlet.

The secondary filter, located in the bag compartment, protects the motor from dirt particles.

Insert new filter into slots (E).

Do not operate cleaner without secondary filter in place.

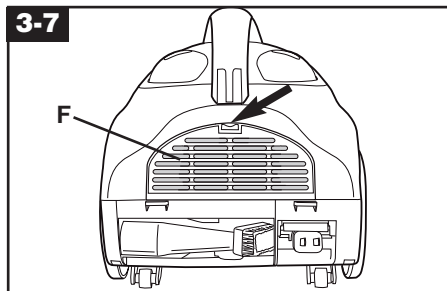

Final filter

Disconnect cleaner from electrical outlet.

To change the final filter, press latch and remove filter door (F).

Discard old filter.

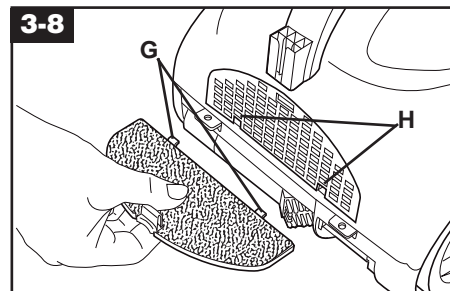

Insert tabs (G) on filter door into slots (H) on cleaner. Snap door closed.

Do not operate cleaner without filters in place.

It is recommended that the secondary and final filters be replaced after every 5 bag changes.

Replace with Hoover bags and filters using HOOVER part no. 40101-002.

Where to buy

Bags and filters may be purchased from your local Authorized Hoover Dealers (Depots), Leading Retailers, Hoover Factory Service Centers, or through The Hoover Company online at www.hoover.com.

Lubrication

The motor is equipped with two bearings that contain sufficient lubrication for the life of the motor. The addition of lubricant could cause damage. Therefore, do not add lubricant to the motor bearings.

Thermal protector

An internal thermal protector has been used in your cleaner to prevent overheating if a large item or clog gets caught in the nozzle or at the opening of the bag.

When the blockage is not removed, the thermal protector will trip and cleaner will stop running.

If this happens, turn cleaner OFF and **disconnect cleaner from electrical outlet**. Then disconnect nozzle and remove obstruction. Within 20 minutes, the thermal protector will cool and automatically reset and cleaning may resume.

If cleaner does not operate, allow additional time for thermal protector to reset.

Service

To obtain approved HOOVER service and genuine HOOVER parts, locate the nearest **Hoover Factory Service Center or Authorized Hoover Warranty Service Dealer (Depot)** by:

- checking the Yellow Pages under "Vacuum Cleaners - Household" OR -
- checking the list of Factory Service Centers provided with this cleaner OR -
- checking the Service section of The Hoover Company online at www.hoover.com OR -
- calling 1-800-944-9200 for an automated referral of authorized service outlet locations (U.S. only).

Please do not send your cleaner to The Hoover Company in North Canton for service, this will only result in delay.

If further assistance is needed, contact The Hoover Company Consumer Response Center, North Canton, Ohio 44720, Phone: 330-499-9499.

In Canada, contact Hoover Canada, Burlington, Ontario L7R 4A8, Phone: 1-800-263-6376.

Always identify your cleaner by the **complete** model number when requesting information or ordering parts. (The model number appears on the bottom of the cleaner.)

4. If you have a problem

If a minor problem occurs, it usually can be solved quite easily when the cause is found by using the check list below.

Problem: Cleaner won't run

Possible cause

Possible solution

- **Not firmly plugged in**
- *Plug in firmly*
- **No voltage in wall receptacle**
- *Check fuse or breaker*
- **Blown fuse/tripped breaker**
- *Replace fuse/reset breaker*

Problem: Cleaner won't pick up

Possible cause

Possible solution

- **Bag full**
- *Replace paper filter bag*
- **Blockage in nozzle, hose or attachments**
- *Remove blockage (see "Clearing blockages" section)*
- **Secondary filter dirty**
- *Replace filter*

Problem: Nozzle won't pick up

Possible cause

Possible solution

- **Blockage in nozzle**
- *Remove blockage (see "Clearing blockages" section)*

Clearing blockages

Remove larger items from carpet and other surfaces before vacuuming to help prevent blockages in hose, wand or nozzle connector, and to maintain cleaning effectiveness of your cleaner.

To check for blockages, proceed with each of the following steps until the blockage is found.

1. Turn cleaner OFF and disconnect wand from hand grip.

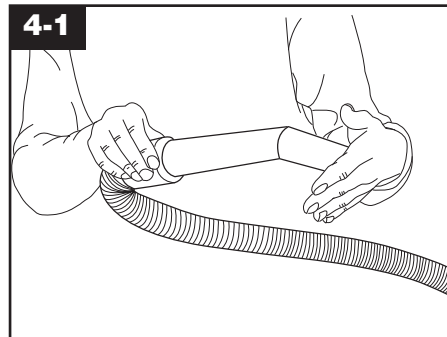

2. Turn cleaner ON and check hose end for suction. Turn cleaner OFF and remove any blockages.

3. Remove nozzle from wands and attach wands to hose. Turn cleaner ON and check for suction.

Turn cleaner OFF and remove any blockages.

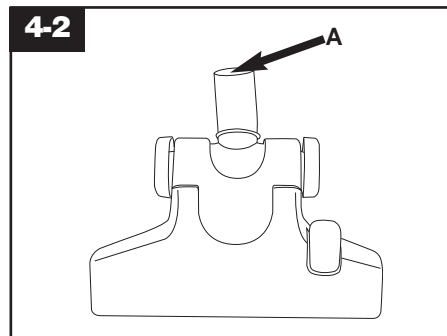

4. Before attaching nozzle to wand, check nozzle connector (A).

Look into nozzle connector and remove any blockages.

Full One Year Warranty (Domestic Use)

Your HOOVER® appliance is warranted in normal household use, in accordance with the Owner's Manual against original defects in material and workmanship for a period of one full year from date of purchase. This warranty provides, at no cost to you, all labor and parts to place this appliance in correct operating condition during the warranted period. This warranty applies when the appliance is purchased in the United States including its territories and possessions, or in Canada or from a U. S. Military Exchange. Appliances purchased elsewhere are covered by a limited one year warranty which covers the cost of parts only. This warranty does not apply if the appliance is used in a commercial or rental application.

This warranty only applies when the product is in use in the country or territory in which it is purchased.

Warranty service can only be obtained by presenting the appliance to one of the following authorized warranty service outlets. Proof of purchase will be required before service is rendered.

1. Hoover Factory Service Centers.
2. Hoover Authorized Warranty Service Dealers (Depots).

For an automated referral of authorized service outlets in the U.S.A., phone 1-800-944-9200 OR

Visit The Hoover Company on-line at www.hoover.com

This warranty does not cover pick up, delivery, or house calls; however, if you mail your appliance to a Hoover Factory Service Center for warranty service, transportation will be paid one way.

While this warranty gives you specific legal rights, you may also have other rights which vary from state to state.

If further assistance is needed, or if there are questions concerning this warranty or the availability of warranty service outlets, write or phone the Consumer Response Center, The Hoover Company, 101 East Maple St., North Canton, Ohio 44720. Phone 1-330-499-9499.

In Canada, contact Hoover Canada, Burlington, Ontario L7R 4A8, 1-800-263-6376.

