

Register your product and get support at  
[www.philips.com/welcome](http://www.philips.com/welcome)

**GoGear**

SA2VBE04



---

EN User manual

---

**PHILIPS**

# Contents

---

<b>1 Important safety information</b>	2
General maintenance	2
Recycling the product and the built-in battery	5

---

<b>2 Your new VIBE</b>	6
What's in the box	6

---

<b>3 Getting started</b>	7
Overview of the controls and connections	7
Limit the volume	7
Overview of the main menu	7
Connect and charge	8
Software loaded on the VIBE	9
Files loaded on the VIBE	9

---

<b>4 Update VIBE</b>	10
Manually verify / update the firmware	10

---

<b>5 Turn VIBE on and off</b>	11
Automatic shut-down	11
Lock the keys	11

---

<b>6 Philips Songbird</b>	12
Build a media library	12
Browse your media library	13
Organize and manage your Songbird library	13
Playlists	14
Change the look of the Songbird library	15
Format VIBE (erase all music and data)	15
Repair VIBE (restore factory settings)	15

---

<b>7 Music</b>	16
Listen to music	16
Navigate inside a music track	16
Play music from a filtered selection	16
Find your music	16

---

<b>8 Audiobooks</b>	18
Add audiobooks to VIBE	18
Audiobook controls	18
Select audiobook by book title	18
Add a bookmark in an audiobook	19
Find a bookmark in an audiobook	19
Delete a bookmark in an audiobook	19

---

<b>9 Video</b>	20
Play videos	20
Navigate inside a video	20
Delete the currently playing video	20
Delete one or more videos	20

---

<b>10 Pictures</b>	21
Add pictures to VIBE	21
View pictures	21
Start a slideshow	21
Delete the currently displayed picture	21
Delete one or more pictures	21

---

<b>11 Use the VIBE to carry data files</b>	22
--	----

---

<b>12 Settings</b>	23
--------------------	----

---

<b>13 Technical data</b>	25
System requirements	25

---

<b>14 Glossary</b>	26
--------------------	----

## Need help?

Please visit

[www.philips.com/welcome](http://www.philips.com/welcome)

where you can access a full set of supporting materials such as the user manual, the latest software updates, and answers to frequently asked questions.

# 1 Important safety information

## General maintenance

The translation of this document is for reference only.

In the event of any inconsistency between the English version and the translated version, the English version shall prevail.

### Caution

- To avoid damage or malfunction:
- Do not expose the product to excessive heat caused by heating equipment or direct sunlight.
- Do not drop the product or allow objects to fall on your player.
- Do not allow the product to be submerged in water. Do not expose headphone socket or battery compartment to water, as water entering the set may cause major damage.
- Active mobile phones in the vicinity may cause interference.
- Back up your files. Ensure that you retain the original files you have downloaded to your device. Philips is not responsible for any loss of data if the product becomes damaged or not readable / legible.
- Manage (transfer, delete, etc.) your music files only with the supplied music software to avoid problems.
- Do not use any cleaning agents containing alcohol, ammonia, benzene, or abrasives as these may harm the product.

### About operating and storage temperatures

- Operate in a place where temperature is always between 0 and 35°C (32 to 95°F)
- Store in a place where temperature is always between -20 and 45°C (-4 to 113°F).
- Battery life may be shortened in low temperature conditions.

**Replacement parts/accessories:**  
Visit [www.philips.com/support](http://www.philips.com/support) to order replacement parts/accessories.

### Hearing Safety



#### Listen at a moderate volume:

Using headphones at a high volume can impair your hearing. This product can produce sounds in decibel ranges that may cause hearing loss for a normal person, even for exposure less than a minute. The higher decibel ranges are offered for those that may have already experienced some hearing loss.

Sound can be deceiving. Over time your hearing 'comfort level' adapts to higher volumes of sound. So after prolonged listening, what sounds 'normal' can actually be loud and harmful to your hearing. To guard against this, set your volume to a safe level before your hearing adapts and leave it there.

To establish a safe volume level:

Set your volume control at a low setting. Slowly increase the sound until you can hear it comfortably and clearly, without distortion.

Listen for reasonable periods of time:

Prolonged exposure to sound, even at normally 'safe' levels, can also cause hearing loss.

Be sure to use your equipment reasonably and take appropriate breaks.

Be sure to observe the following guidelines when using your headphones.

Listen at reasonable volumes for reasonable periods of time.

Be careful not to adjust the volume as your hearing adapts.

Do not turn up the volume so high that you can't hear what's around you.

You should use caution or temporarily discontinue use in potentially hazardous situations.

Do not use headphones while operating a motorized vehicle, cycling, skateboarding, etc.; it

may create a traffic hazard and is illegal in many areas.

### Modifications

Modifications not authorized by the manufacturer may void user's authority to operate the product.

### Copyright information

All other brands and product names are trademarks of their respective companies or organizations.

Unauthorized duplication of any recordings whether downloaded from the Internet or made from audio CDs is a violation of copyright laws and international treaties.

The making of unauthorized copies of copy-protected material, including computer programs, files, broadcasts and sound recordings, may be an infringement of copyrights and constitute a criminal offense. This equipment should not be used for such purposes.

The Windows Media and the Windows logo are registered trademarks of Microsoft Corporation in the United States and/or other countries.

### Be responsible! Respect copyrights.



**Be responsible  
Respect copyrights**

Philips respects the intellectual property of others, and we ask our users to do the same. Multimedia content on the internet may have been created and/or distributed without the original copyright owner's authorization.

Copying or distributing unauthorized content may violate copyright laws in various countries including yours.

Compliance with copyright laws remains your responsibility.

The recording and transfer to the portable player of video streams downloaded to your computer is intended only for use with public domain or properly licensed content. You may only use such content for your private,

non-commercial use and shall respect eventual copyright instructions provided by the copyright owner of the work. Such instruction may state that no further copies shall be made. Video streams may include copy protection technology that prohibits further copying. For such situations the recording function will not work and you will be notified with a message.

### Data logging

Philips is committed to improving the quality of your product and enhancing the Philips user experience. To understand the usage profile of this device, this device logs some info / data to the non-volatile memory region of the device. These data are used to identify and detect any failures or problems you as a user may experience while using the device. The data stored, for example, will be the duration of playback in music mode, duration of playback in turner mode, how many times battery low was encountered, etc. The data stored do not reveal the content or media used on the device or the source of downloads. The data stored on the device are retrieved and used ONLY if the user returns the device to the Philips service center and ONLY to simplify error detection and prevention. The data stored shall be made available to user on user's first request.

### Monkey's Audio decoder

- ① The Monkey's Audio SDK and source code can be freely used to add APE format playback, encoding, or tagging support to any product, free or commercial. Use of the code for proprietary efforts that don't support the official APE format require written consent of the author.
- ② Monkey's Audio source can be included in GPL and open-source software, although Monkey's Audio itself will not be subjected to external licensing requirements or other viral source restrictions.

- ③ Code changes and improvements must be contributed back to the Monkey's Audio project free from restrictions or royalties, unless exempted by express written consent of the author.
- ④ Any source code, ideas, or libraries used must be plainly acknowledged in the software using the code.
- ⑤ Although the software has been tested thoroughly, the author is in no way responsible for damages due to bugs or misuse.

If you do not completely agree with all of the previous stipulations, you must cease using this source code and remove it from your storage device.

### FLAC decoder

Copyright (C) 2000,2001,2002,2003,2004,2005, 2006,2007,2008,2009 Josh Coalson

Redistribution and use in source and binary forms, with or without modification, are permitted provided that the following conditions are met:

- Redistributions of source code must retain the above copyright notice, this list of conditions and the following disclaimer.
- Redistributions in binary form must reproduce the above copyright notice, this list of conditions and the following disclaimer in the documentation and/or other materials provided with the distribution.
- Neither the name of the Xiph.org Foundation nor the names of its contributors may be used to endorse or promote products derived from this software without specific prior written permission.

THIS SOFTWARE IS PROVIDED BY THE COPYRIGHT HOLDERS AND CONTRIBUTORS "AS IS" AND ANY EXPRESS OR IMPLIED WARRANTIES, INCLUDING, BUT NOT LIMITED TO, THE IMPLIED

WARRANTIES OF MERCHANTABILITY AND FITNESS FOR A PARTICULAR PURPOSE ARE DISCLAIMED. IN NO EVENT SHALL THE FOUNDATION OR CONTRIBUTORS BE LIABLE FOR ANY DIRECT, INDIRECT, INCIDENTAL, SPECIAL, EXEMPLARY, OR CONSEQUENTIAL DAMAGES (INCLUDING, BUT NOT LIMITED TO, PROCUREMENT OF SUBSTITUTE GOODS OR SERVICES; LOSS OF USE, DATA, OR PROFITS; OR BUSINESS INTERRUPTION) HOWEVER CAUSED AND ON ANY THEORY OF LIABILITY, WHETHER IN CONTRACT, STRICT LIABILITY, OR TORT (INCLUDING NEGLIGENCE OR OTHERWISE) ARISING IN ANY WAY OUT OF THE USE OF THIS SOFTWARE, EVEN IF ADVISED OF THE POSSIBILITY OF SUCH DAMAGE.

### XPAT XML Parser

Copyright (c) 1998, 1999, 2000 Thai Open Source Software Center Ltd

Permission is hereby granted, free of charge, to any person obtaining a copy of this software and associated documentation files (the "Software"), to deal in the Software without restriction, including without limitation the rights to use, copy, modify, merge, publish, distribute, sub-license, and/or sell copies of the Software, and to permit persons to whom the Software is furnished to do so, subject to the following conditions:

The above copyright notice and this permission notice shall be included in all copies or substantial portions of the Software. THE SOFTWARE IS PROVIDED "AS IS", WITHOUT WARRANTY OF ANY KIND, EXPRESS OR IMPLIED, INCLUDING BUT NOT LIMITED TO THE WARRANTIES OF MERCHANTABILITY, FITNESS FOR A PARTICULAR PURPOSE AND NON-INFRINGEMENT. IN NO EVENT SHALL THE AUTHORS OR COPYRIGHT HOLDERS BE LIABLE FOR ANY CLAIM, DAMAGES OR OTHER LIABILITY, WHETHER IN AN

ACTION OF CONTRACT, TORT OR OTHERWISE, ARISING FROM, OUT OF OR IN CONNECTION WITH THE SOFTWARE OR THE USE OR OTHER DEALINGS IN THE SOFTWARE.

## Recycling the product and the built-in battery

Your product is designed and manufactured with high quality materials and components, which can be recycled and reused. Never dispose of your product with other household waste. Please inform yourself about the local rules on the separate collection of electrical and electronic products and batteries. The correct disposal of these products helps prevent potentially negative consequences on the environment and human health. Please visit [www.recycle.philips.com](http://www.recycle.philips.com) for additional information on a recycling center in your area.



### Caution

- Removal of the built-in battery invalidates the warranty and can destroy the product.



### Notice for the USA

This equipment has been tested and found to comply with the limits for a Class B digital device, pursuant to part 15 of the FCC Rules. These limits are designed to provide reasonable protection against harmful interference in a residential installation. This equipment generates, uses, and can radiate radio frequency energy and, if not installed and used in accordance with the instruction manual, may cause harmful interference to radio communications. However, there is no guarantee that interference will not occur in a particular installation. If this equipment does cause harmful interference to radio or television reception,

which can be determined by turning the equipment off and on, the user is encouraged to try to correct the interference by one or more of the following measures:

- Relocate the receiving antenna.
- Increase the separation between equipment and receiver.
- Connect the equipment into an outlet on a circuit different from that to which the receiver is connected.
- Consult the dealer or an experienced radio/TV technician for help.

### Notice for Canada

This Class B digital apparatus complies with Canadian ICES-003.

The set complies with the FCC-Rules, Part-15 and with 21 CFR 1040.10. Operation is subject to the following two conditions:

- This device may not cause harmful interference, and
- This device must accept any interference received, including interference that may cause undesired operation.

## 2 Your new VIBE

VIBE allows you to

- play music
- watch videos

### Note

- The images serve as reference only. Philips reserves the right to change color/design without notice.

---

### What's in the box

Check that you have received the following items:  
Player



Earphones

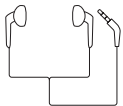

USB cable



Quick start guide



# 3 Getting started

## Overview of the controls and connections

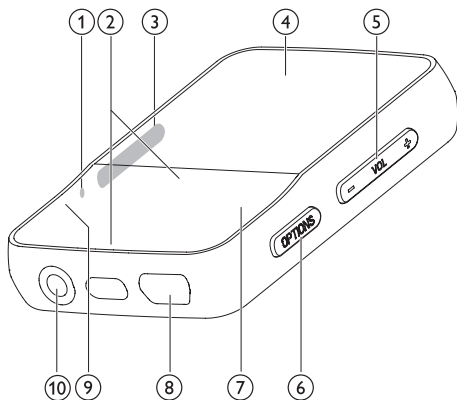

- ① **RESET**    press: reset GoGear Vibe
- ② ▲ / ▼    press: scroll up/down  
press and hold: scroll up/down at high speed
- ③ ①        slide and hold: turn GoGear Vibe on/off  
🔒        slide: lock/unlock all buttons except **- VOL +**
- ④        display
- ⑤ **- VOL +**    press: increase/decrease the volume  
press and hold: increase/decrease fast
- ⑥ **OPTIONS**    view available options
- ⑦ ▶||        press: play/pause
- ⑧ 🔌        USB connection jack
- ⑨ ↶        press: back one level  
press and hold: scroll back at high speed
- ⑩ 🎧        headphone jack

## Limit the volume

### ! Caution

- Listening to loud sounds for longer than a moment can be harmful to the listener.

You can set the volume level of VIBE to limit the maximum volume output.

- 1 From the main menu, select **[Settings]** > **[Sound settings]** > **[Volume limit]**.
- 2 Press the volume controls **- / +** to adjust the level.
- 3 Press **▶||** to confirm.
  - ↳ When you set a volume limit, VIBE can no longer exceed the set volume, even if you press the button to increase the volume **+**.

To enable maximum volume again:

- 1 Select **[Settings]** > **[Sound settings]** > **[Volume limit]**.
- 2 Set the volume limit to maximum.
- 3 Press **▶||** to confirm.

## Overview of the main menu

Menu	Mode	To
🎵	Music	play digital audio tracks
📺	Video	play videos
🖼️	Pictures	view pictures
📁	Folder	view files in folders view
⚙️	Settings	customize the settings of VIBE
🎧	Now playing	show the current play screen



---

## Connect and charge

VIBE has a built-in battery that can be charged through the USB port of a computer (USB cable included).

### Note

- When you connect VIBE to a computer, you are briefly prompted to select:
- **[Charge & transfer]** or **[Charge & play]**.
- VIBE automatically applies **[Charge & transfer]**, if no new selection is made.

---

## Connect VIBE to a computer

- 1** Connect the USB plug of the supplied USB cable to a spare USB port on your computer.
- 2** Connect the small USB plug of the USB cable to the small USB jack on VIBE.
- 3** Turn on your computer.  
↳ VIBE charges.

---

## Install Philips Songbird for the first time

When you connect VIBE to the PC for the first time, a pop-up window appears:

- 1** Select **Install Philips Songbird**.
- 2** Follow the on-screen instructions to complete the installation.

### Note

- The installation requires you to agree to the license terms.

If the pop-up window is not displayed automatically:

- 1** Select **My Computer** (Windows XP / Windows 2000) / **Computer** (Windows Vista / Windows 7).
- 2** Right click on the **Philips GoGear VIBE** icon.
- 3** Select **Install Philips Songbird (Setup.exe)**.
- 4** Follow the on-screen instructions to complete the installation.

### Note

- The installation requires you to agree to the license terms.

## Install the Philips Songbird software again (after the first installation)

### Important!

The Philips Songbird software installer is preloaded to VIBE.





To free memory capacity for your media content on VIBE, the installer file is automatically deleted during the first installation process.

If you want to install the software any time after the first installation, follow these instructions:

- 1 Connect VIBE to the computer.
- 2 Ensure that the computer is connected to the Internet, and then open Windows Explorer.
- 3 In Windows Explorer, right click on VIBE, and then select the option to install **Philips Songbird**.
  - ↳ The computer downloads the installer file from the Internet.
- 4 Follow the on-screen instructions to complete the installation.

## Battery level indication

The display indicates the approximate levels of the battery status as follows:

				
100%	75%	50%	25%	0%

- ↳ A flashing battery screen indicates that the battery is low. The player saves all settings and switches off within 60 seconds.

### Note

- Rechargeable batteries have a limited number of charge cycles. Battery life and number of charge cycles vary by use and settings.
- The charging animation stops and the  icon is displayed when the charging process is completed.

### Tip

- You can conserve battery power and increase the play time of VIBE if you go to **\* > [Display Settings] > [Screen off timer]** and ensure that the shortest timer setting is selected.

## Software loaded on the VIBE

VIBE comes with the following software:

- **Philips Songbird** (helps you update the firmware of VIBE and transfer your media files).

## Files loaded on the VIBE

The following files are loaded on VIBE:

- User Manual
- Frequently Asked Questions
- Safety and warranty information
- Worldwide warranty information

## 4 Update VIBE

VIBE is controlled by an internal program called firmware. Newer versions of the firmware may have been released after you have purchased VIBE.

The software program called **Philips Songbird** can use your computer to check for firmware updates that are available on the Internet. Install **Philips Songbird** on your computer (see chapter **Install software**) and follow the instructions to update (see chapter **Manually verify / update the firmware**).



### Note

- Your music files are not affected by a firmware update.

---

### Manually verify / update the firmware

- 1 Ensure that your computer is connected to the Internet.
- 2 Connect VIBE to the computer (see section **Connect and charge** for instructions).
- 3 On your computer, click **Start > Programs > Philips > Philips Songbird** to launch the Philips Songbird application.
- 4 Click VIBE in the Player pane. Then, select **Tools > Check for updated firmware** in the pop-up window.
  - ↳ **Philips Songbird** checks for updates and installs new firmware from the Internet, if available.
- 5 Follow the on-screen instructions to update the firmware of VIBE.
- 6 Wait until the update is completed, then disconnect VIBE from the computer.
  - ↳ VIBE restarts after the firmware is updated and is ready for use again.

## 5 Turn VIBE on and off

- 1 To toggle between modes on and off, slide and hold  for approximately 2 seconds.

---

### Automatic shut-down

VIBE has an automatic shut-down feature that can save battery power.

After 10 minutes in idle mode (no music plays, no button is pressed), VIBE turns off.

- 1 Slide and hold  for approximately 2 seconds to turn VIBE on again.

---

### Lock the keys

VIBE has a lock switch to prevent accidental operation.

- 1 To lock the buttons when you play, move the slider to position .
  - ↳ All buttons except the volume keys are locked and the display shows a lock icon.
- 2 To unlock the buttons again, move the slider to the center position.

# 6 Philips Songbird

VIBE comes with the Philips Songbird software.

The Philips Songbird software helps you to:

- purchase new media (music and videos) online
- create a media library
- manage your media library
- play music and videos
- sync your media with the VIBE

When Philips Songbird is launched for the first time, choose from the following options to import media files into the Songbird media library:

- Import an existing iTunes library.
- Scan for media files in specific directories. (You can select to watch a folder, so that the files that are added or deleted there are automatically added or deleted in the Songbird media library.)

---

## Build a media library

Use one or more of the following options to build a media library with Songbird:

---

### Rip a CD

By default, the Philips Songbird software installs the following add-ons that are needed to rip a CD:

- CD Rip Support
- Gracenote Metadata Lookup Provider

---

### Set up the CD rip options

- 1 On the computer, launch the Songbird program.
- 2 Select **Tools > Options...**
- 3 Select the **CD Rip** tab, and then choose your CD rip options.
- 4 Click on **OK** to confirm.

---

### Import media files from a directory

The following steps show how you can import media (music and video) files that are stored elsewhere on your computer or computer network:

- 1 On the computer, launch the Songbird program.
- 2 On the Songbird toolbar, click **File**, then select **Import Media...**
- 3 Select your media (music and video) files, then click **OK**.
  - ↳ The media files that you added are listed in the media library.



Tip

- If you select a folder that contains music or video files, the software scans the folder and adds all the music or video files it contains to the media library (duplicate titles are ignored).

---

### Import media from iTunes

- 1 On the computer, launch the Songbird program.
- 2 Select **Tools > Options...**
- 3 On the Songbird toolbar, select the **Media Importer** tab, then **iTunes Import/Export**.
- 4 Verify your library location and options.
- 5 Select **Import Library**.
  - ↳ The software imports the iTunes library into Songbird.

## Export media to iTunes

- 1 On the computer, launch the Songbird program.
- 2 Select **Tools > Options...**
- 3 On the Songbird toolbar, select the **Media Importer** tab, then **iTunes Import/Export**.
- 4 Verify your library location and options.
- 5 Select **Export Library**.
  - ↳ The software exports the library from Songbird to iTunes.

## Get content from online sources

You can purchase content from online sources such as the following:

- 7-digital

Check the specifications of your VIBE to see what services are available to you.

## Browse your media library

The Songbird media library is structured as follows:

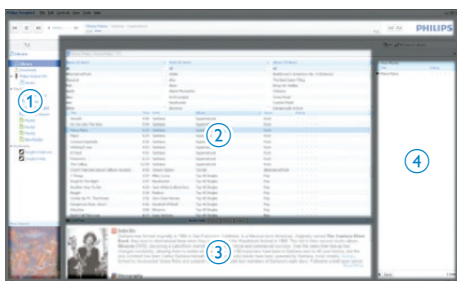

- ① Player Pane (this is where the VIBE is displayed)
- ② Library Pane (this is where you find the contents of your library)
- ③ Service Pane (this is where you find additional information about contents, such as playlists)
- ④ Information Pane (this is where you find information about the selected options)

## Organize and manage your Songbird library

### Let Songbird manage your media

- 1 On the computer, launch the Songbird program.
- 2 Select **Tools > Options...**
- 3 On the Songbird toolbar, select the **Manage Files** tab.
- 4 Check **Allow Songbird to manage my files**.
- 5 Set the options on how you want to organize your media.

### Remove media files from the Songbird media library

- 1 In the Songbird library, right click on a media file, then select **Remove**.
- 2 In the prompt window, click **Remove** to confirm that you want to remove the file.
  - ↳ The selected file is removed from the library and from all playlists. (By default, the file is only "removed", not "deleted". The media file still exists in its original location on the computer or computer network.)



#### Tip

- To select multiple files on the computer (PC), press and hold **Ctrl**.
- To select multiple consecutive files, press and hold **Shift**.

---

## Delete media

This is how to delete media files in Windows Explorer:

- 1 With VIBE connected to the computer, open Windows explorer.
- 2 Locate the media folder in VIBE.
- 3 Delete the media file in the same way as you would from any other location on the computer.

---

## Let Songbird watch a folder

You can let Songbird

- monitor the contents of a folder, and
- add or remove the media from your library to match the folder contents.

- 1 On the computer, launch the Songbird program.
- 2 Select **Tools > Options...**
- 3 On the Songbird toolbar, select the **Media Importer** tab, and then **Watch Folders**.
- 4 Select the folder that you want Songbird to watch for changes.
  - ↳ The selected folder is watched and Songbird matches the library content to the content of the folder.

---

## Fetch album artwork

Choose from these options to fetch the artwork for your albums:

- 1 On the computer, launch the Songbird program.
  - On the Songbird toolbar, select **Tools > Get Album Artwork**.
    - ↳ If no titles are selected, Songbird fetches the artwork for all titles in the library.
  - Right-Click on selected titles.
    - ↳ Songbird fetches the artwork for all selected titles.

---

## Playlists

By default, the Philips Songbird software installs the following add-ons that are needed to rip a CD:

- CD Rip Support
- Gracenote Metadata Lookup Provider

---

## Create a playlist

- 1 On the computer, launch the Songbird program.
- 2 Choose from these options to create a new playlist:
  - On the Songbird toolbar, select **File > New Playlist**.
  - Right-click on the left hand sidebar, and then choose **New Playlist**.
  - Click the **+** symbol at the bottom of the left hand side Service Pane.
    - ↳ A new playlist appears in the Service Pane.
- 3 Enter a name for the new playlist.

---

## Add titles to a playlist

- 1 On the computer, launch the Songbird program.
- 2 Select one or more titles.
- 3 Choose from these options to add the selected titles to a playlist:
  - Drag and drop the selected titles to the playlist in the Service Pane.
  - Right-click on the selection, and then select **Add to Playlist > The\_name\_of\_your\_playlist**.
    - ↳ All selected titles are added to the playlist.

## Remove titles from a playlist

- 1 On the computer, launch the Songbird program.
- 2 Select a playlist.
- 3 Right-click on the title that you want to remove, and then **Remove**.
  - ↳ The selected title is removed from the playlist.

## Change the look of the Songbird library

You can change the design and color scheme of the Songbird library. We call this "changing feathers". New feathers are installed and managed like add-ons.

Find new feathers

- 1 On the computer, launch the Songbird program.
- 2 On the Songbird toolbar, select **View > Feathers > Get More Feathers...**
  - ↳ The software searches for new feathers.
  - ↳ Follow the on-line instructions to install the new feathers.

## Format VIBE (erase all music and data)

**Philips Songbird** has a Format feature that you can use to format VIBE and erase all your files from the internal memory.

### ! Caution

- The following procedure erases all your files that are stored on VIBE.

- 1 Install **Philips Songbird** on your computer (see chapter **Install software**), and then launch the program.
- 2 In the **Philips Songbird** player pane, click on VIBE.
- 3 In the library pane, click on the tab called **Tools**.
- 4 In the tools pane, click on **Format device**.
- 5 Follow the on-screen instructions to complete the repair procedure.

## Repair VIBE (restore factory settings)

**Philips Songbird** has a repair feature that you can use to restore VIBE to the factory settings. Before you proceed, back up your files that are stored on VIBE if possible.

### ! Caution

- The following procedure erases all your files that are stored on VIBE, and restores the factory settings.

- 1 Install **Philips Songbird** on your computer (see chapter **Install software**), and then launch the program.
- 2 In the **Philips Songbird** menu bar (at the top), click on the **Tools** pull-down menu and then select **Repair My VIBE**.
- 3 Follow the on-screen instructions to complete the repair procedure.

# 7 Music

## Listen to music

- 1 From the main menu, select **🎵** to enter the music mode.
- 2 Navigate the sub-menus to select the music track.
- 3 Press **▶||** to toggle between play and pause.
  - Press **OPTIONS** to see more music options.
  - Press **↶** to go back one level.
  - Press and hold **↶** to return to the main menu.

## Navigate inside a music track

- 1 While you listen to a music track, press **▲ / ▼** to quickly navigate forward / backwards inside the track.
  - Press **OPTIONS** to view more music options.

## Play music from a filtered selection

- 1 While you listen to music, press **OPTIONS** and then select **[Play mode] > [Play music from...]**.
- 2 Select the selection filter (example: selection filter[... **this album**] plays only music from the currently playing album).
  - ↳ VIBE plays only music from the filtered selection.

## Find your music

From the main menu, select **🎵** to enter music mode.

VIBE offers the following menu options:

### [All songs]

- Alphabetically listed tracks

### [Artists]

- Alphabetically listed artists
- Alphabetically listed albums
- Tracks listed in album order

### [Albums]

- Alphanumerically listed albums
- Tracks listed in album order

### [Album art]

- Alphanumerically listed album art

### [Playlists]

- **[Playlist-on-the-go]**
- Tracks listed in playlist order

### [Audiobooks]\*

- Books listed in alphanumerical order

### Note

- \* You can purchase audiobooks at online stores such as audible.com.
- VIBE handles the audiobooks like music files.

## Delete the currently playing music track

This is how to delete the currently playing music track:

- 1 While you listen to the music track, press **OPTIONS**.
- 2 Select the option to delete the music track.
- 3 Select **[Yes]** to confirm the deletion.

## Delete one or more music tracks

Use the **Philips Songbird** software to sync your media files.

Alternatively, you can delete music in Windows Explorer:

- 1 Connect VIBE to the computer.
- 2 In Windows Explorer, locate the music folder in VIBE.
- 3 Delete the music as you normally would on the computer.





### Note

- Alternatively, you can select  from the main menu and find your files in folder view.

# 8 Audiobooks

VIBE supports books in audio format. The use of this feature requires that you download the **AudibleManager** from audible.com. With the **AudibleManager** you can manage the digital contents of your audiobooks. Visit audible.com and register. The onscreen instructions guide you through the **AudibleManager** software download process.

## Add audiobooks to VIBE







- **Important:** VIBE supports audiobook format  or format .
- 1 On your computer, launch **AudibleManager**.
  - 2 Follow the online instructions to download your audiobooks in format  or format .
  - 3 Follow the **AudibleManager** on-screen instructions to activate VIBE for your audiobooks.
  - 4 Follow the **AudibleManager** on-screen instructions to transfer your audiobooks to VIBE.

### Note

- VIBE can only play audiobooks for which it is activated.

## Audiobook controls









VIBE offers the following audiobook mode controls:

Goal	Action
Play / pause	Press 
Skip forward to beginning of new section / chapter	Press 
Skip back to beginning of current section / chapter	Press 
Fast skip forwards through audiobook	Press and hold 
Fast skip backwards through audiobook	Press and hold 
Access options menu	Press <b>OPTIONS</b>
Return to browsing menu	Press 
Increase / decrease volume	Press <b>- VOL +</b>

### Tip

- You can resume play after navigating away from audiobooks.

## Select audiobook by book title

- 1 From the main menu, select  to enter music mode.
- 2 Press  or , then  to select **Audiobooks**.
- 3 Press  or  to select title, then  to play.
  - To exit, press .

---

## Add a bookmark in an audiobook

- 1 In audiobook play mode, press **OPTIONS**.
- 2 Press ▲ or ▼, then ►|| to select **[Bookmarks]**.
- 3 Press ▲ or ▼, then ►|| to select **[Add bookmark]**.
  - ↳ The display shows a confirmation screen.
  - To exit, press ↵.

---

## Find a bookmark in an audiobook

- 1 In audiobook play mode, press **OPTIONS**.
- 2 Press ▲ or ▼, then ►|| to select **[Bookmarks]**.
- 3 Press ▲ or ▼, then ►|| to select **[Go to bookmark]**.
- 4 Press ▲ or ▼ to select the bookmark in the list.
- 5 Press ►|| to go to the selected bookmark.
  - To exit, press ↵.

---





## Delete a bookmark in an audiobook

- 1 In audiobook play mode, press **OPTIONS**.
- 2 Press ▲ or ▼, then ►|| to select **[Bookmark [x]]**.
- 3 Press ▲ or ▼, then ►|| to select **[Delete bookmark]**.
- 4 Press ▲ or ▼ to select the bookmark in the list.
- 5 Press ►|| to delete the selected bookmark.
  - To exit, press ↵.

# 9 Video



---

## Play videos

- 1 From the main menu, select  to enter the video mode.
- 2 Navigate the sub-menus to select the video.
- 3 Press  to toggle between play and pause.
  - Press **OPTIONS** to see more video options.
  - Press  to go back one level.
  - Press and hold  to return to the main menu.

---

## Navigate inside a video

- 1 While you watch a video, press  /  to quickly navigate forward / backwards inside the video.
  - Press **OPTIONS** to view more video options.

---

## Delete the currently playing video

This is how to delete the currently playing video:

- 1 While you watch the video, press **OPTIONS**.
- 2 Select the option to delete the video.
- 3 Select **[Yes]** to confirm the deletion.

---

## Delete one or more videos

Use the **Philips Songbird** software to sync your media files.

Alternatively, you can delete music in Windows Explorer:

- 1 Connect VIBE to the computer.
- 2 In Windows Explorer, locate the video folder in VIBE.
- 3 Delete the video as you normally would on the computer.

### Note







- Alternatively, you can select  from the main menu and find your files in folder view.

# 10 Pictures

## Add pictures to VIBE

- 1 Connect VIBE to the computer.
- 2 In Windows Explorer, create folders in VIBE.
- 3 Use drag and drop actions to sort your pictures into the folders.

## View pictures

- 1 From the main menu, select  to enter the picture mode.
- 2 Navigate the sub-menus to select the picture.
- 3 Press  to view the picture in full-screen mode.
- 4 Press  /  to rotate the picture.
  - Press **OPTIONS** to see more picture options.
  - Press  to go back one level.
  - Press and hold  to return to the main menu.

## Start a slideshow

- 1 While you view a video in full-screen mode, press  to start a slideshow.
  - Press **OPTIONS** to view more slideshow options.

## Delete the currently displayed picture

This is how to delete the currently displayed picture:

- 1 While you view the picture in full-screen mode, press **OPTIONS**.
- 2 Select the option to delete the picture.
- 3 Select **[Yes]** to confirm the deletion.

## Delete one or more pictures

Use a computer to delete pictures in Windows Explorer:

- 1 Connect VIBE to the computer.
- 2 In Windows Explorer, locate the picture folder in VIBE.
- 3 Delete the pictures as you normally would on the computer.



### Note

- Alternatively, you can select  from the main menu and find your files in folder view.

# 11 Use the VIBE to carry data files

This is how you use VIBE to store and carry data files:

- 1 Connect VIBE to the computer (for instructions see section **Connect and charge**).
- 2 On the computer in Windows Explorer, copy the data files and paste them to VIBE.



## Tip







- Use the computer to transfer your data files back to the computer, or delete your data files from VIBE.

# 12 Settings

This is how you customize VIBE:

From the main menu, select  to enter settings mode.

In the  menu, navigate as follows:

- 1 Press  /  to select an option.
- 2 Press  to confirm a selection and go to the next level (when available).
  - Press  to return to the previous level.
  - Press and hold  to exit the  menu.

In the  menu, the following options are available:

Settings	Options menu	Sub-options menu
Play mode	Play music from...	<ul style="list-style-type: none"> <li>• All songs</li> <li>• ...this album</li> <li>• ...this artist</li> </ul>
	Repeat	<ul style="list-style-type: none"> <li>• Repeat off (default)</li> <li>• Repeat 1</li> <li>• Repeat all</li> </ul>
	Shuffle	<ul style="list-style-type: none"> <li>• Shuffle off (default)</li> <li>• Shuffle all</li> </ul>
Sound settings	FullSound	<ul style="list-style-type: none"> <li>• Off (default)</li> <li>• On*</li> </ul>
	Equalizer	<ul style="list-style-type: none"> <li>• Off (default)</li> <li>• Rock</li> <li>• Funk</li> <li>• Hip hop</li> <li>• Jazz</li> <li>• Classical</li> <li>• Techno</li> <li>• Custom</li> </ul>
	Volume limit	<ul style="list-style-type: none"> <li>• Off (default)</li> <li>• Set</li> </ul>
Display settings	Theme	<ul style="list-style-type: none"> <li>• Black (default)</li> <li>• Blue</li> <li>• Red</li> </ul>
	Backlight timer	<ul style="list-style-type: none"> <li>• 15 sec. (default)</li> <li>• 30 sec.</li> <li>• 45 sec.</li> <li>• Always on</li> </ul>
	Sleep timer	<ul style="list-style-type: none"> <li>• Time left: [x] minutes</li> <li>• Off (default)</li> <li>• Set</li> </ul>

Settings	Options menu	Sub-options menu	
Language	<ul style="list-style-type: none"> <li>• Czech</li> <li>• Greek</li> <li>• English (default)</li> <li>• Danish</li> <li>• German</li> <li>• Spanish</li> <li>• French</li> <li>• Italian</li> </ul>	<ul style="list-style-type: none"> <li>• Hungarian</li> <li>• Dutch</li> <li>• Norwegian</li> <li>• Polish</li> <li>• Portuguese</li> <li>• Portuguese (Brazilian)</li> <li>• Russian</li> <li>• Slovak</li> </ul>	<ul style="list-style-type: none"> <li>• Finnish</li> <li>• Swedish</li> <li>• Turkish</li> <li>• Simplified Chinese</li> <li>• Traditional Chinese</li> <li>• Japanese</li> <li>• Korean</li> </ul>
Information	Capacity Free space Firmware version Support site		
Factory settings	Restore factory settings? (Files are not affected.)	<ul style="list-style-type: none"> <li>• Yes</li> <li>• No</li> </ul>	

\*Equalizer deactivates when FullSound is selected.

# 13 Technical data

---

## Power

Power supply: 250 mAh Li-ion polymer internal rechargeable battery

Play time<sup>1</sup>

- music: 24 hours

- video: 4 hours

---

## Software

Philips Songbird: to update firmware and transfer music

---

## Connectivity

Headphone 3.5 mm

USB 2.0 High speed

---

## Sound

Channel separation: 45 dB

Frequency Response: 80 - 18,000 Hz

Output power: 2 x 3.0 mW

Signal to noise ratio: > 84 dB

---

## Audio playback

Supported formats:

MP3:

MP3 bit rates: 8 - 320 kps and VBR

MP3 sample rates: 8, 11.025, 16, 22.050, 32, 44.1, 48 kHz

WMA:

WMA bit rates: 5 - 320 kbps

WMA sample rates: 8, 11.025, 16, 22.050, 32, 44.1, 48 kHz

WAV

FLAC

APE

---

## Video playback

Supported formats:

MJPEG (in .mp4)

---

## Picture display

Supported formats:

JPEG

BMP

---

## Storage media

Built-in memory capacity<sup>2</sup>:

SA2VBE04 4GB NAND Flash

---

## Display

Color LCD 128 x 128 pixels

---

## Note

- <sup>1</sup> Rechargeable batteries have a limited number of charge cycles. Battery life and number of charge cycles vary by use and settings.
- <sup>2</sup> 1GB = 1 billion bytes; available storage capacity is less. Full memory capacity may not be available as some memory is reserved for the player. Storage capacity is based on 4 minutes per song and 128 kbps MP3 encoding.

---

## System requirements

- Windows® XP (SP3 or above) / Vista / 7
- Pentium III 800 MHz processor or higher
- 512 MB RAM
- 500 MB hard disk space
- Internet connection
- Windows® Internet Explorer 6.0 or later
- CD-ROM drive
- USB port

# 14 Glossary

---

## B

### Bit rate

Bit rate is the number of bits that are conveyed or processed per unit of time. The bit rate is usually measured in some multiple of bits per second (kilobits per second: kbps). The term bit rate is a synonym for data transfer rate (or simply data rate).

---

## C

### Compression

In audio terms, this is a process of temporarily or permanently reducing audio data for more efficient storage or transmission. A temporary reduction in file size is called 'non-lossy' compression, and no information is lost. A permanent reduction in file size (such as with MP3 files) is called 'lossy' compression, and involves discarding unnecessary information which is irretrievably lost.

---

## D

### Decibel (dB)

A unit of measure used to express relative difference in power or intensity of sound.

---

## F

### Frequency Response

Is the range of frequencies that a speaker reproduces, lowest frequency to the highest. While the optimal normal is 20-20,000 Hz (Hertz), the range of human hearing for individuals is often much more restricted. A good full-range speaker system however, reproduces as much of this range as possible to cover all variations. Individual drivers are limited to reproduce only that part of the spectrum for which they were made, so their response is limited, but still a necessary point to consider when designing a complete sound system.

### FullSound

FullSound™ is an innovative technology designed by Philips. FullSound™ faithfully restores sonic details to compressed music, enhancing it to provide a full sound experience without any distortion.

---

## L

### LCD (Liquid Crystal Display)

Probably the most common way to show visual information on non-computer electronic equipment.

### Lossless compression

A system for reducing the number of data bits (density) in a musical signal without corrupting the original.

---

## M

### MP3

A file format with a sound data compression system. MP3 is the abbreviation of Motion Picture Experts Group 1 (or MPEG-1) Audio Layer 3. With the MP3 format, one CD-R or CD-RW can contain about 10 times more data than a regular CD.

### **MSC [Mass Storage Class]**

The USB mass storage device class (or USB MSC or UMS) is a set of computing communications protocols that provide an interface to storage devices. Devices that support this standard are referred to as MSC (Mass Storage Class) devices.

### **MTP [Media Transfer Protocol]**

Media Transfer Protocol supports the transfer of music and video files to portable audio and video players.

---

## **R**

### **Rip (ripping)**

Using a software program that “grabs” digital audio from a compact disc and transfers it to a computer hard drive. The integrity of the data is preserved, because the signal does not pass through the computer sound card, and need not be converted to an analog format. The digital-to-digital transfer creates a WAV file that can then be converted into an MP3 file.

---

## **S**

### **SuperScroll**

SuperScroll™ is a navigation feature of the double-action search keys of the product. SuperScroll™ allows easy speed control when scrolling through large libraries to swiftly find items within large libraries. Longer press of the button results in faster scroll speed.

