

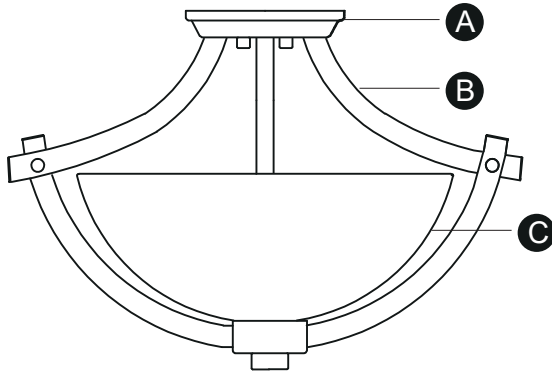

Questions, problems, missing parts?

Before returning to your retailer, call our customer service at 1-800-887-6326
 Monday – Friday 9:00 a.m. – 5:00 p.m. CST

PACKAGE CONTENTS



(For Semi-Flush)

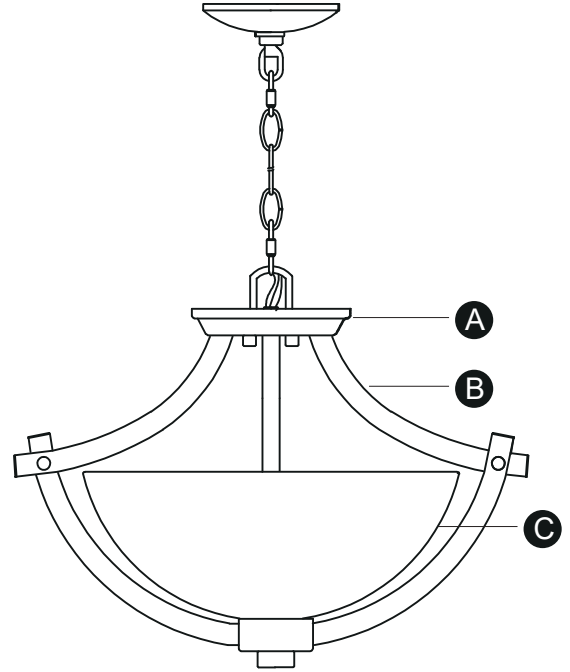

(For Pendant)

HARDWARE CONTENTS

For Semi-Flush

AA		Mounting Strap Unit X1	CC		Wire Connector X3
BB		Mounting Screw X2	DD		Ball Nut X2

For Pendant

EE		Canopy X1	II		Mounting Screw X2
FF		Collar X1	JJ		Wire Connector X3
GG		Loop Lock X2	KK		Chain X1
HH		Mounting Strap Unit X1			



SAFETY INFORMATION

Please read and understand this entire manual before attempting to assemble, operate or install the product.

WARNING

- Turn off electricity at main fuse box (or circuit breaker box) before beginning installation by removing fuse (or switching off circuit breaker).
- Be careful not to damage or cut the wire insulation (covering) during fixture installation. Do not permit wires to contact any surface having a sharp edge. To do so may damage or cut the wire insulation, which could cause serious injury or death from electric shock.

CAUTION

- All electrical connections must be in agreement with local codes, ordinances or the national electric code (NEC). Contact your municipal building department to learn about your local codes, permits and/or inspections.
- Risk of fire – most dwellings built before 1985 have supply wire rated for 140°F/60°C. Consult a qualified electrician before installation.
- Do not connect this fixture to an electrical system that does not provide a means for equipment grounding. Never use a fixture in a two-wire system that is not grounded. If you are not sure your lighting system has a grounding means, do not attempt to install this fixture. Contact a qualified, licensed electrician for information with regards to proper grounding methods as required by the local electrical code in your area.

PREPARATION

Before beginning assembly, installation or operation of product, make sure all parts are present. Compare parts with package contents list and diagram on previous page. If any part is missing or damaged, do not attempt to assemble, install or operate the product. Contact customer service for replacement parts.

Tools Required for Assembly (not included): Screwdriver, Phillips Screwdriver, Pliers, Electrical Tape, Wire Cutters, Safety Glasses, Ladder, Wire Stripper.

ASSEMBLY INSTRUCTIONS (For Pendant)

Turn off the power at fuse or circuit box.

1. Secure the mounting strap unit (HH) to the outlet box with mounting screws (II) .

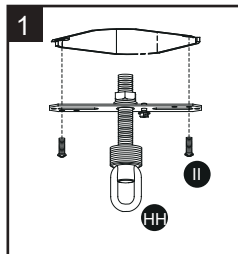

2. Secure the tube onto fixture canopy (A), thread threaded pipe through tube .

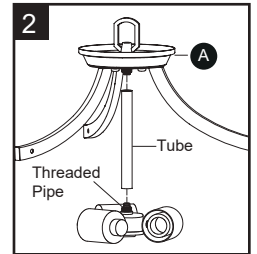

3. Slip the glass shade (C), metal pad and washer through the threaded pipe. Secure the fixture arms (B) as the figure (See page 1) shows, then secure the set screws and bolt nuts. Finally tighten the fixture with the finial.

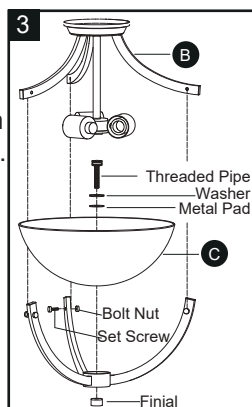

4. - Determine length of chain (KK) needed to achieve desired fixture height. (To remove excess chain section, use pliers to bend link open.)
- Weave the fixture wires and fixture ground wire through the chain (KK), and the canopy (EE).
 - Connect the chain (KK) to the loop and the top loop on the mounting strap unit (HH) with the two loop locks (GG).
 - Thread the fixture wires and fixture ground wire through the center of the mounting strap unit (HH).

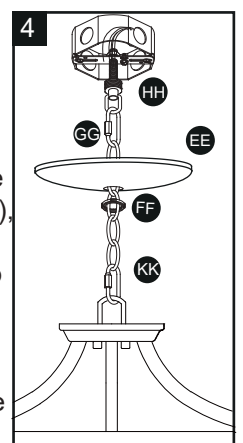

ASSEMBLY INSTRUCTIONS (continued)

5. Connect the smooth wire from the fixture (marked) to black wire from the outlet box (power), the ribbed wire from the fixture (unmarked) to white wire from the outlet box (neutral) with the wire connectors (JJ) provided. Connect the copper wire on the light fixture to the mounting strap unit (HH) by securing it with the preinstalled ground screw, then connect it to the house ground wire with wire connectors (JJ). Carefully put all the wires into outlet box.

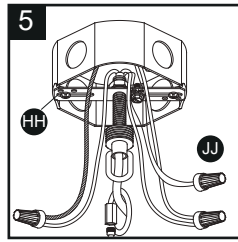

6. Secure the canopy (EE) to the mounting strap unit (HH), then secure it by tightening the collar (FF).

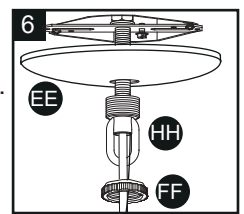

7. Install 3 X 60W medium base ST15 vintage bulbs (LL) (included). See relamping label at socket area or packaging for maximum allowed wattage.

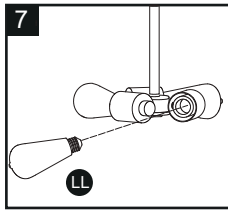

Turn on the power at the main fuse or circuit breaker box.

ASSEMBLY INSTRUCTIONS (For Semi-Flush)

Turn off the power at fuse or circuit box.

1. Secure the mounting strap unit (AA) to the outlet box by using two short mounting screws (BB).

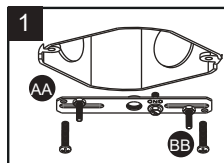

2. Secure the tube onto fixture canopy (A), thread threaded pipe through tube.

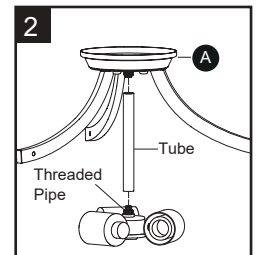

3. Slip the glass shade (C), metal pad and washer through the threaded pipe. Secure the fixture arms (B) as the figure (See page 1) shows, then secure the set screws and bolt nuts. Finally tighten the fixture with the finial.

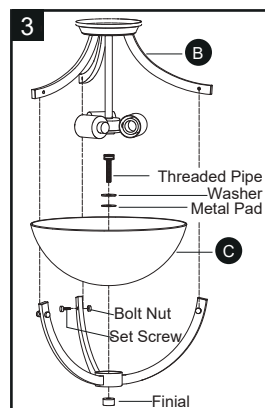

4. Connect the smooth wire from the fixture (marked) to black wire from the outlet box (power), the ribbed wire from the fixture (unmarked) to white wire from the outlet box (neutral) with the wire connectors (CC) provided. Connect the copper wire on the light fixture to the mounting strap unit (AA) by securing it with the preinstalled ground screw, then connect it to the house ground wire with wire connectors (CC). Carefully put all the wires into outlet box.

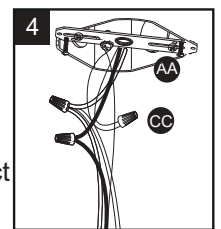

5. Secure the fixture canopy (A) to the mounting strap unit (AA) and secure it with the ball nuts (DD).

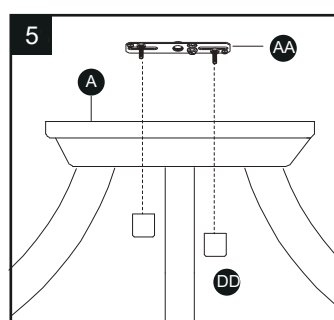

6. Install 3 X 60W medium base ST15 vintage bulbs (LL) (included). See relamping label at socket area or packaging for maximum allowed wattage.

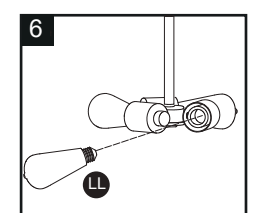





Turn on the power at the main fuse or circuit breaker box.

The following parts are available for re-order if damaged or missing. Call our toll free at 1-800-887-6326.







Spare Parts List:

Parts Number (6118MM) For Semi-Flush:

AA  Mounting Strap Unit X1	CC  Wire connector X3
BB  Mounting Screw X2	DD  Ball Nut X2

→ Assembly Kit 6118MM (1 SET)

Parts Number (6117MM) For Pendant:

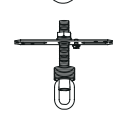
EE  Canopy X1	II  Mounting Screw X2
FF  Collar X1	JJ  Wire Connector X3
GG  Loop Lock X2	KK  Chain X1
HH  Mounting Strap Unit X1	

→ Assembly Kit 6117MM (1 SET)

LL  Vintage Bulb 60W 8080CEB

C  Glass Shade 10099CE

CARE AND MAINTENANCE

- To clean, turn off and wipe with a damp, non-abrasive cloth.

TROUBLESHOOTING

- 1) **The light does not work:**
 - a) Make sure the wall switch and circuit breaker are on.
 - b) Make sure the wiring is correct.
- 2) **Fuse blows or circuit trips when light is turned on.**

Check for crossed wires, ensure wiring is correct.

If unable to fix any of the above issues, please consult a certified electrician.

FIVE-YEAR LIMITED WARRANTY: If, during normal use, this PATRIOT LIGHTING® lighting fixture breaks or fails due to a defect in material workmanship within five (5) years from the date of original purchase, simply bring this lighting fixture with the original sales receipt back to your nearest MENARDS® retail store. At its discretion, PATRIOT LIGHTING® agrees to have the product or any defective part(s) repaired or replaced with the same or similar PATRIOT LIGHTING® product or part free of charge, within the stated warranty period, when returned by the original purchaser with original sales receipt. This warranty; (1) excludes expendable parts including but not limited to light bulbs; (2) does not cover damage that has resulted from abuse or misuse; and (3) does not cover any losses, labor, injuries to persons/property or costs. This warranty does give you specific legal rights and you may have other rights, which vary from state to state.



Questions, problems, missing parts?

Before returning to your retailer, call our customer service at 1-800-887-6326
Monday – Friday 9:00 a.m. – 5:00 p.m. CST