

---

---

**CONSERVATOR<sup>®</sup>**

---

---



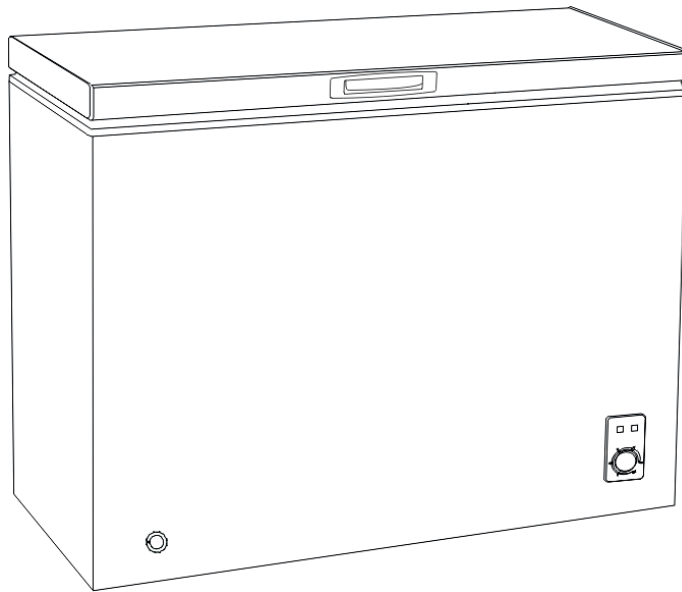

## **CHEST FREEZER**



## **INSTRUCTION MANUAL**

**Model No.: VFL050SW  
VFL070SW  
VFL090SW  
VFCL14SW  
VFCL18SW**

## IMPORTANT SAFETY INSTRUCTIONS

	<b>CAUTION</b> <b>RISK OF ELECTRIC SHOCK</b> <b>DO NOT OPEN</b>	
	This symbol indicates that dangerous voltage constituting a risk of electric shock is present within your refrigerator.	
	This symbol indicates that there are important operating and maintenance instructions in the literature accompanying your refrigerator.	

## WARNING

1. Read these instructions.
2. Keep these instructions.
3. Heed all warnings.
4. Follow all instructions.
5. Do not use your refrigerator near water.
6. Clean only with a damp cloth.
7. Do not block any ventilation openings. Install in accordance with the manufacturer's instructions.
8. Do not install near any heat sources, such as radiators, heat registers, stoves, or other apparatus (including amplifiers) that produce heat.
9. Do not defeat the safety purpose of the polarized or grounding-type plug. A polarized plug has two blades with one wider than the other. A grounding type plug has two blades and a third grounding prong. The wide blade or the third prong is provided for your safety. If the provided plug does not fit into your outlet, consult an electrician for replacement of the obsolete outlet.
10. Protect the power cord from being walked on or pinched, particularly at plugs, convenience receptacles, and the point where it exits from your refrigerator.
11. Do not attempt to modify or extend the power cord of your refrigerator.
12. Unplug your refrigerator during lightning storms or when it will not be used for long periods of time.
13. Make sure that the available AC power matches the voltage requirements of your refrigerator.
14. Do not handle the plug with wet hands. This could result in an electric shock.
15. Unplug the power cord by holding the plug, never by pulling the cord.
16. Turn off your refrigerator before unplugging it.
17. Refer all servicing to qualified service personnel. Servicing is required when your refrigerator has been damaged in any way, such as the power-supply cord or plug is damaged, liquid has been spilled or objects have fallen into your refrigerator, your refrigerator has been exposed to rain or moisture, does not operate normally, or has been dropped.
18. To reduce the risk of fire or electric shock, do not expose your refrigerator to rain, moisture, dripping, or splashing, and no objects filled with liquids should be placed on top of it.
19. Do not use extension cords or ungrounded (two prong) adapters. If the power cord is too short, have a qualified electrician install an outlet near your refrigerator. Use of an extension cord can negatively affect your refrigerator's performance.
20. Your refrigerator is not intended for use by persons (including children) with reduced physical, sensory, or mental capabilities, or lack of experience and knowledge, unless they have been given supervision or instruction concerning use of your refrigerator by a person responsible for their safety.
21. Children should be supervised to ensure that they do not play with your refrigerator.
22. If the power cord is damaged, it must be replaced by the manufacturer, its service agent, or similarly qualified person, in order to avoid a hazard.



**Failure to follow these instructions can result in electric shock, fire, or death.**

**1.WARNING**—Keep ventilation openings, in both your refrigerator and the built-in structure, clear of obstruction.

**2.WARNING**—Do not touch the interior of your freezer with wet hands. This could result in frostbite.

**3.WARNING**—Do not use mechanical devices or other means to accelerate the defrosting process, other than those recommended by the manufacturer.

**4.WARNING**—Do not damage the refrigerant circuit.

**5.WARNING**—Do not damage the refrigerant tubing when handling, moving, or using your refrigerator.

**6.WARNING**—DANGER—Never allow children to play with, operate, or crawl inside your refrigerator.

**Risk of child entrapment. Before you throw away your old freezer:**

- Take off the door.
- Leave the shelves in place so that children may not easily climb inside.

**7. WARNING**—Do not use electrical appliances inside the food storage compartments of the appliance unless they are of the type recommended by the manufacturer.

**8.** Unplug your refrigerator before carrying out user maintenance on it.

**9. If power cord is damaged, it must be replaced by the manufacturer, its service agent, or similar qualified persons in order to avoid a hazard.**

**10.** Follow local regulations regarding disposal of your refrigerator due to flammable refrigerant and gas. All refrigeration products contain refrigerants, which under the guidelines of federal law must be removed before disposal. It is the consumer's responsibility to comply with federal and local regulations when disposing of this product.

**11.** Do not store explosive substances such as aerosol cans with a flammable propellant in this appliance.

**12. The appliance is not intended for use by persons (including children) with reduced physical, sensory, or mental capabilities, or lack of experience and knowledge, unless they have been given supervision or instruction concerning use of your refrigerator by a person responsible for their safety.**

**Children should be supervised to ensure that they do not play with your refrigerator.**

**13.** This appliance is intended to be used in household and similar applications such as

- staff kitchen areas in shops, offices and other working environments.
- farmhouses and by clients in hotels, motels and other residential type environments.
- bed and breakfast type environments.
- catering and similar non-retail applications.

## Grounding requirement

Your refrigerator must be grounded. Your refrigerator is equipped with a cord having a grounding wire with a grounding plug. The plug must be inserted into an outlet that is correctly installed and grounded.

Incorrect use of the grounding plug can result in a risk of electric shock. Consult a qualified electrician or service person if the grounding instructions are not completely understood, or if doubt exists as to whether your refrigerator is correctly grounded.

### NAMES OF THE PARTS

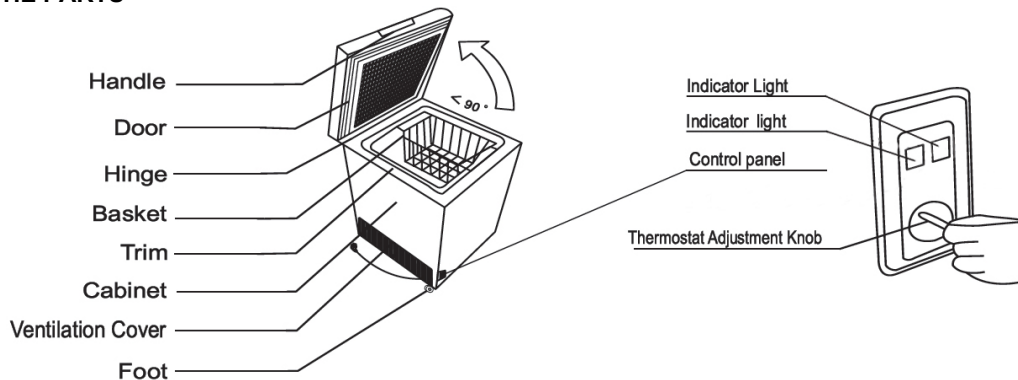

**⚡WARNING⚡:** Never touch the interior of the Freezer Chamber or frozen foods in the compartment with wet hands as this could result in frost bite.

If YOUR UNIT HAS A LOCK, KEEP THE KEY OUT OF REACH OF CHILDREN AND NOT IN THE VICINITY OF THE FREEZER.

### TRANSPORTATION INSTRUCTIONS

The appliance should be transported only in a vertical upright position. The packing as supplied must be intact during transportation.

If during the course of transport the product has been transported horizontally, it must only be laid on its left hand side (when facing the door front) and it must not be operated for at least 4 hours to allow the system to settle after the appliance is brought back to upright position.

1. Failure to comply with the above instructions could result in damage occurring to the appliance. The manufacturer will not be held responsible if these instructions are disregarded.

2. The appliance must be protected against rain, moisture and other atmospheric influences.

**IMPORTANT:** Care must be taken while cleaning / carrying the appliance to avoid touching the condenser metal wires at the back of the appliance, as you might injure your fingers and hands or damage your product.

**IMPORTANT:** This appliance is not designed for stacking with any other appliance. Do not attempt to sit or stand on top of your appliance as it is not designed for such use. You could injure yourself or damage the appliance.

**IMPORTANT:** Make sure that mains cable is not caught under the appliance during and after carrying / moving the appliance, to avoid the mains cable becoming cut or damaged."

When positioning your appliance take care not to damage your flooring, pipes, wall coverings etc. Do not move the appliance by pulling by the lid or handle. Do not allow children to play with the appliance or tamper with the controls. Our company declines to accept any liability should the instructions not be followed.

**INSTALLATION INSTRUCTIONS**

1. If possible, avoid placing the appliance near cookers, radiators or in direct sunlight as this will cause the compressor to run for long periods. If installed next to a source of heat or refrigerator, maintain the following minimum side clearances:
 

From Ranges/stoves	4" (100 mm)
From Radiators/heaters	12" (300 mm)
From Fridges	4" (100 mm)

2. Make sure that sufficient room is provided around the appliance to ensure free air circulation. Ideally, A space of no less than 100 mm (4" in) must be left around the freezer, and ensure you allow gaps as shown in the below diagram.

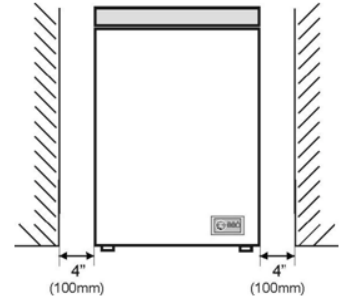

3. The appliance should be located on a smooth surface.
4. It is forbidden to use the refrigerator outdoors.
5. Protection from moisture. Do not locate the freezer in moist space to avoid the metal parts rusty. And do not spray water to the freezer, otherwise it will weaken the insulation and causes current leakage.
6. Refer to "Cleaning and Care" section to prepare your appliance for use.
7. If the freezer is installed in unheated areas, garages etc., in cold weather condensation may form on the outer surfaces. This is quite normal and is not a fault. Remove the condensation by wiping with a dry cloth.

**STARTING**

**Final Check**

Before you starting to use the freezer, please check that:

1. The interior is dry and air can circulate freely at the rear.
2. Clean the interior as recommended under "CLEANING AND CARE".
3. Insert the plug into the wall socket and switch on the electricity supply, then the Red light is on. Avoid accidental disconnection by taping over the switch. Green light will glow, and the compressor will start running.
4. You will hear a noise as the compressor starts up. The liquid and gases sealed within the refrigeration system may also give rise to noise, whether the compressor is running or not which is quite normal.
5. If you going to store already frozen food open the freezer lid and check that the freezer has reached the correct temperature. Then you can put in your already frozen food.
6. Do not load the appliance immediately after it is switched on. Wait until the correct storage temperature has been reached. We recommend that you check the temperature with an accurate thermometer.

**Important Notes:**

- If there is a power failure do not open the lid. Frozen food should not be affected if the failure lasts for less than 20 hours. If the failure is longer, then the food should be checked and eaten immediately or cooked and then refrozen.
- If you find that the lid of the chest freezer is difficult to open just after you have closed it, don't worry. This is due to the pressure difference which will equalize and allow the lid to be opened normally after a few minutes.

**FREEZER OPERATION**

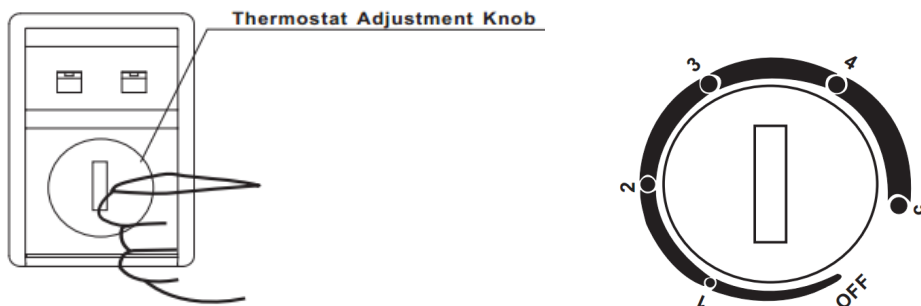

**Temperature adjustment**

The temperature of the freezer is adjusted by means of the knob assembled on the thermostat. "1, 2, 3, 4, 5" do not represent a specific temperature. The smaller the No. the higher the temperature, whereas. So, position "5" is being the lowest temperature.

Figures mean:

"OFF" Forced Shutdown Point

1—5: Frozen Interval (from 1 =@10 degrees F to 5 =@-20 degrees F )



The achieved temperatures can vary according to the conditions of use of the appliance, such as: place of the appliance, ambient temperature, and frequency of lid opening, extent of filling with food of the freezer. The position of the thermostat knob will change according to these factors. Normally, for an ambient temperature of approx. 77 degrees F, the thermostat should be adjusted to the mild position.

We recommended that you check the temperature with a thermometer to ensure that the Freezer is kept to the desired temperature. Remember you must take your reading very quickly since the thermometer temperature will rise very rapidly after you remove it from the freezer.

Please remember each time the lid is opened cold air escapes and the internal temperature rises. Therefore, never leave the lid open and ensure it is closed: immediately after Food is put in or removed.

#### **Indicator lights**

The indicator light set is placed on the front side of the freezer for easy visibility.

Indicator lights mean the following:

- Red Light – shows that the appliance is supplied with electric energy.
- Green Light – shows that the compressor is working.

#### **STORING FROZEN FOOD**

Prepackaged commercially frozen food should be stored in accordance with the frozen food manufacturer's instructions for a  freezer compartment.

To ensure that the high quality achieved by the frozen food manufacturer and the food retailer is maintained the following should be remembered:

1. Put packets in the freezer as quickly as possible after purchase.
2. Do not exceed "Use By", "Best Before" dates on the packaging.

#### **FREEZING FRESH FOOD**

Place fresh food to be frozen near the side walls to ensure fast freezing and away from already frozen food, if possible.

Never exceed this maximum capacity. Do not freeze too large a quantity at any one time.

The quality of the food is best preserved when it is frozen right through to the centre as quickly as possible.

Take special care not to mix already frozen food and fresh food.

#### **DEFROSTING**

Defrost twice a year or when a frost layer of around 7 mm (1/4") has formed.

Alternatively you may switch off the freezer at the socket outlet and pull out the mains plug.

Extract the water conduit and put in a water container.

6 hours before the defrosting, please set the thermostat knob at "MAX" position to make sure the food is at the lowest temperature when you get it out. All food should be wrapped in several layers of newspaper and stored in a cool place (e.g. fridge or larder).

Remove the freezer basket. Leave the lid open. Containers of warm water may be placed carefully in the freezer to speed up the defrosting.

Never use hairdryers, electrical heaters or other such electrical appliances for defrosting. When defrosting has finished flow out defrost water which collects at the bottom of the freezer as the below diagram and dry the interior thoroughly. Switch on the Fast Freeze and leave it on for about three hours.

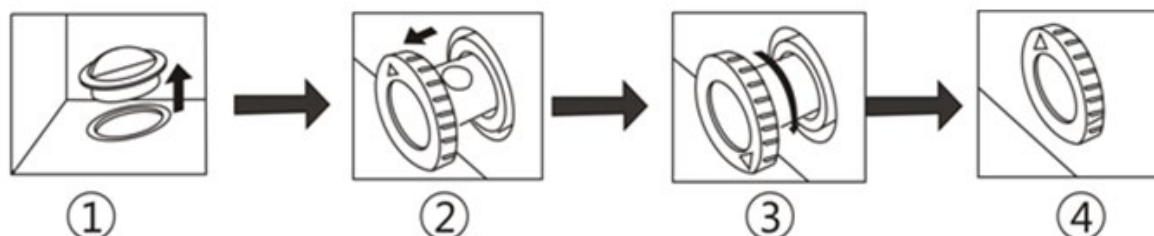

1. A drain outlet is designed at the bottom of the freezer liner, and when defrosting, remove its rubber cover (you can find the rubber cover in the freezer accessory bag and be sure to install it by yourself), then the defrosting water flows out and is discharged from the drain pipe. (NOTES: PLEASE KEEP THE RUBBER COVER WELL DURING THE DEFROSTING AND PUT IT BACK AFTER DEFROSTING IS DONE )
2. Extract the water conduit by 20-25mm until the water hole can be seen.
3. Twist the water conduit until the arrow points downward.
4. After defrosting is done, make sure there is no more water coming out before out the water conduit in place and make the arrow point upward.

#### **Important Notes:**

- Do not use pointed or sharp-edged objects such as knives or forks to remove the frost.
- Never use hairdryers, electrical heaters or other such electrical appliances for defrosting.
- It is normal that water beads or frosts appear on the freezer collar and door gaskets in the wet weather, which will not affect the normal use. In such case, please clean it with a dry cloth in time!

#### **CLEANING AND CARE**

\*\* We recommend that you switch off the freezer at the socket outlet and pull out the mains plug before cleaning.

\*\* Never use any sharp abrasive instrument, soap, household cleaner, detergent and wax polish for cleaning.

\*\* Use lukewarm water to clean the cabinet of the freezer and wipe it dry.

\*\* Use a damp cloth wrung out in a solution of one teaspoon of bicarbonate of soda to one pint of water to clean the interior and wipe it dry.

\*\* Excess deposit of ice should be removed on a regular basis using a plastic ice scraper available from your local store. Large accumulation of ice will impair the performance of the freezer.

\*\* If the freezer is not going to be used for a long period of time switch it off, remove all food, clean it and leave the lid ajar.

\*\* Check lid seals regularly to ensure they are clean and free from food particles.

**Important Notes:**

Never use water wash the compressor position, wipe it with a dry cloth thoroughly after cleaning to prevent rust.

**DO'S AND DON'TS**

**Do** – Defrost food from the freezer thoroughly in a fridge or in a microwave oven following defrosting and cooking instructions.

**Do** – Ensure that chest freezer lid is completely closed after each use.

**Do** – Defrost frozen meat completely before cooking.

**Do** – Close the lid gently.

**Do** – Check contents of the freezer at regular intervals.

**Do** – Clean and defrost your freezer regularly (See “Defrosting”)

**Do** – Keep food for as short a time as possible and adhere to “Best Before”, “Use By” dates.

**Do** – Store commercially frozen food in accordance with the instructions given on the packets that you buy.

**Do** – Always choose high quality fresh food and be sure it is thoroughly clean before you freeze it.

**Do** – Prepare fresh food for freezing in small portions to ensure rapid freezing.

**Do** – Wrap all foods in aluminum foil or freezer quality plastic bags and make sure any air is excluded.

**Do** – Wrap frozen food when you buy it and put it in to the freezer as soon as possible.

**Do** – Store small items in the basket provided.

**Do** – Remove ice cream from the freezer 10-20 minutes before serving.

**Don't** – Leave the lid open for long periods as this will make the freezer more costly to run and cause excessive ice formation.

**Don't** – Use pointed sharp edged objects such as knives, forks to remove the ice.

**Don't** – Put hot food in the freezer. Let it cool down first.

**Don't** – Put liquid-filled bottles or sealed cans containing carbonated liquids into the freezer as they may burst.

**Don't** – Store poisonous or dangerous substances in the freezer. Your freezer has been designed for the storage of edible foodstuffs only.

**Don't** – Consume ice-cream and water ices direct from the freezer. The low temperature may cause ‘freezer burns’ on lips.

**Don't** – Freeze fizzy drinks.

**Don't** – Try to keep frozen food which has thawed, it should be eaten within 24 hours or cooked and refrozen.

**Don't** – Remove items from the freezer with wet hands.

**Don't** – Shut the lid with force. You will damage the appliance.

• This appliance is not intended for use by persons (including children) with reduced physical, sensory, mental capabilities, or lack of experience and knowledge, unless they have been given

supervision or instruction concerning use of the appliance by a person responsible for their safety.

• Children should be supervised to ensure that they do not play with the appliance.

• Do not store explosive substances such as aerosol cans with a flammable propellant in this appliance.

• This appliance is intended to be used in household and similar applications such as staff kitchen areas in shops, offices and other working environment farm houses and by clients in hotels, motels and other residential type environments; bed and breakfast type environments catering and similar not-retail applications. It is NOT intended for commercial or restaurant use.

• If the supply cord is damaged, it must be replaced by manufacture, its service agent or similarly qualified persons in order to avoid a hazard.

**ELECTRICAL INFORMATION**

**THIS APPLIANCE MUST BE EARTHED.**

This appliance is fitted with a fused three pin plug to BS 1363 which will be suitable for use in all houses fitted with sockets to current specifications.

If the fitted plug is not suitable for your socket outlets, it should be cut off and carefully disposed of. To avoid a possible shock hazard, do not insert the discarded plug into a socket.

This appliance complies with the following EEC Directives:

73 / 23 EEC (Low Voltage Directive)

89 / 336 EEC (EMC Directive).

Correct Disposal of this product	
	This marking indicates that this product should not be disposed with other household wastes throughout the EU. To prevent possible harm to the environment or human health from uncontrolled waste disposal, recycle it responsibly to promote the sustainable reuse of material resources. To return your used device, please use the return and collection systems or contact the retailer where the product was purchased. They can take this product for environmental safe recycling.

