

MYKESONIC

VERTICAL TURNTABLE

Model: YY1638

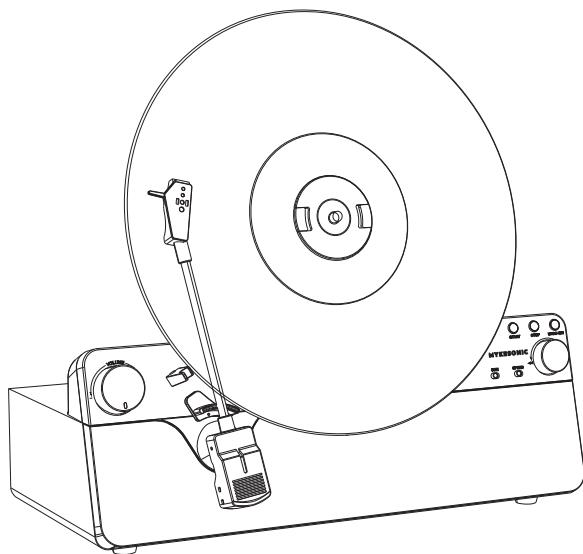

Instruction Manual

Please read this instruction manual carefully before use and keep it for future reference.



CONTENTS

TABLE OF CONTENTS

SAFETY INSTRUCTIONS 3 - 4

PRODUCTION OVERVIEW 5

INSTALLATION 45RPM ADAPTOR..... 6

SETUP OPERATION 7

BASIC OPERATION 8 - 9

TROUBLE SHOOTING 10

SPECIFICATIONS 11

FCC / IC STATEMENTS 12 - 13

SAFETY INSTRUCTIONS

Please read the following safety instructions and respect the warnings before the appliance is operated:

1. Always follow basic safety precautions when using this appliance, especially when children are present.
2. Children should be supervised to ensure that they do not play with the appliance.
3. Do not damage the power cord, place heavy objects on it, stretch or bend it.
4. Do not attach extension cables. Damage to the power cord may cause fire or electric shock.
5. If the supply cord is damaged, it must be replaced by the manufacturer, a service agent or similarly qualified persons in order to avoid a hazard.
6. Ensure that the unit is plugged into an AC 100-240V 50/60Hz power outlet. Using higher voltage may cause the unit to malfunction or catch fire.
7. If the power plug does not fit into the socket, do not force it.
8. Turn off the unit before unplugging it from power source to completely switch it off.
9. Do not disconnect or connect the power cord with wet hands. This may cause an electric shock.
10. If the unit is not going to be used for a long period time, disconnect the power supply.
11. Ensure that the mains plug is always easily accessible.
12. This product does not contain any parts that are serviceable by the user. In case of a fault, contact the manufacturer or authorised service department. Exposing the internal parts inside the device may endanger your life.
13. The manufacturers guarantee does not extend to faults caused by repairs carried out by unauthorized third parties.
14. Do not use this product immediately after unpacking. Wait until it warms up to room temperature before using it.
15. Ensure this product is used in moderate climates only (not in tropical/subtropical climates).
16. Place product on a flat, stable surface that is not subject to vibrations.
17. Ensure the product and its parts are not overhanging the edge of the supporting furniture.
18. To reduce the risk of fire, electric shock or damage to this product, do not expose it to direct sunlight, dust, rain and moisture.
19. Never expose it to dripping or splashing and do not place objects filled with liquids on or near the product.
20. Do not place objects filled with liquids, such as vases, on the apparatus.



SAFETY INSTRUCTIONS



For indoor use only.



Use only power supply listed in the user manual.

21. Do not install near any heat sources such as radiators, heat registers, stoves, or other apparatus (including amplifiers) that produce heat.
22. Do not place the product where the humidity is high and ventilation is poor.
23. Ensure a minimum distance of 5 cm around the apparatus for sufficient ventilation. Do not block any ventilation openings of this product.
24. Always ensure that the ventilation openings are not covered with items such as newspapers, table-cloths, curtains, etc.
25. NEVER let anyone, especially children, push anything into holes, slots or any other openings in the unit's casing as this could result in a fatal electric shock.
26. Storms are dangerous for all electric appliances. If the mains or aerial wiring is struck by lightning, the appliance might get damaged, even if it is turned off. You should disconnect all the cables and connectors of the appliance before a storm.



The exclamation point within an equilateral triangle is intended to alert the user to the presence of important operating and maintenance (servicing) instructions in the literature accompanying the appliance.

PRODUCT OVERVIEW

FRONT VIEW / REAR VIEW

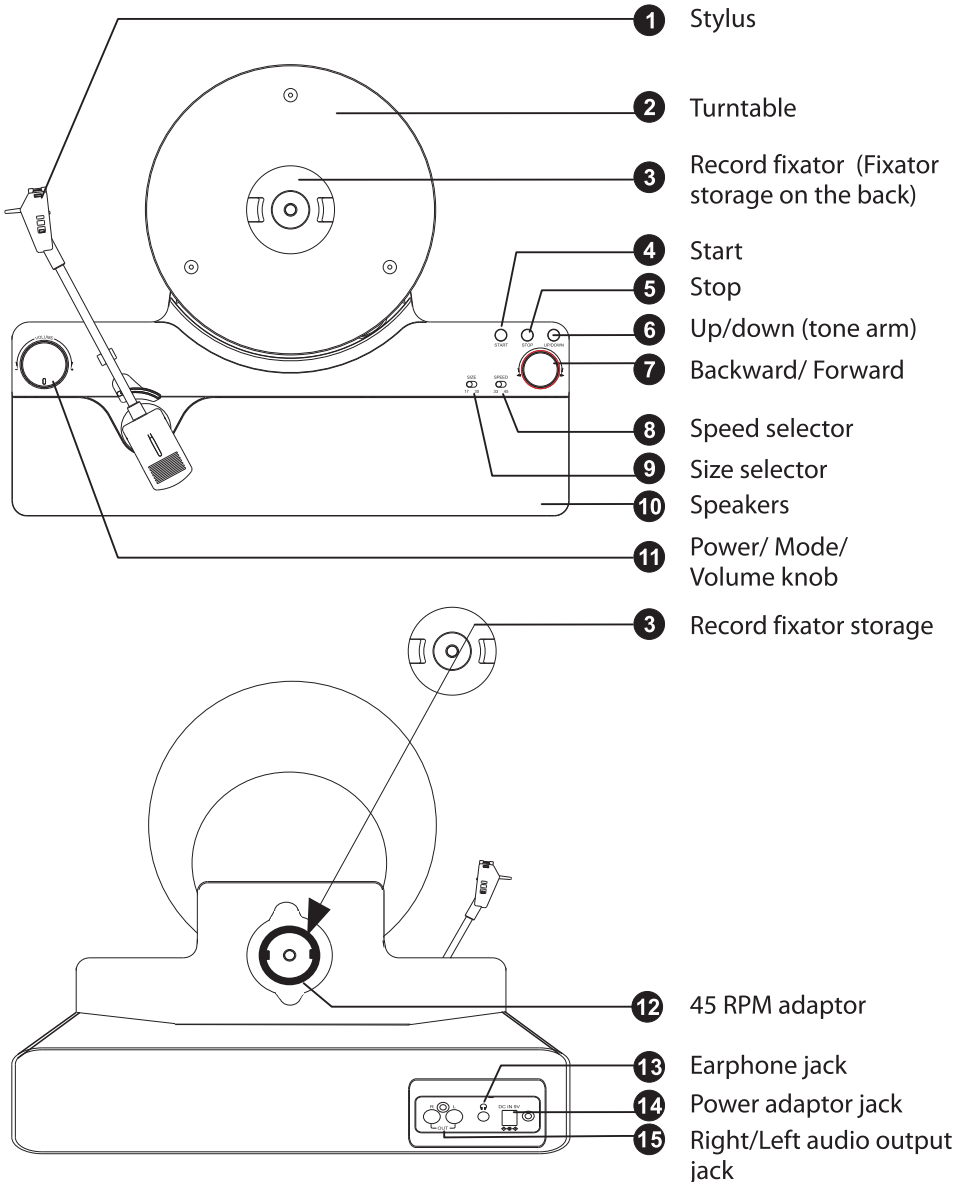

45RPM ADAPTOR INSTALLATION

INSTALLATION STEPS FOR THE 45 RPM ADAPTOR

1. Take out Record fixator and the 45 RPM adaptor from the rear panel.

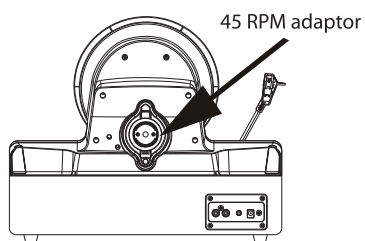
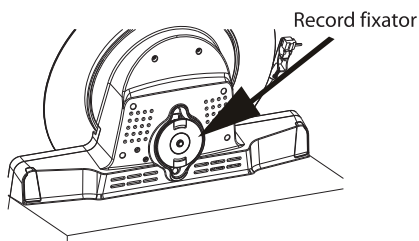

2. Put the 45 RPM adaptor on the 45 RPM record.
3. Fix the 45 RPM adaptor to the record fixator.

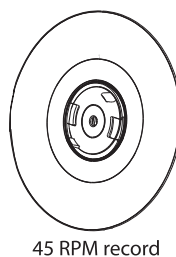
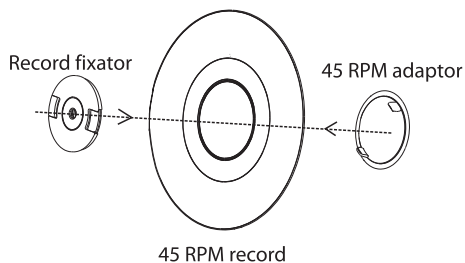

4. Pinch the record fixator and put it on the platter.

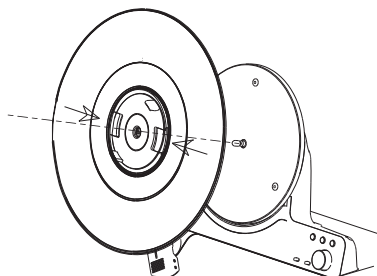

SETUP OPERATION

SETUP

1. Remove the white protective needle cover by gently pulling towards front of the unit.
2. Remove the packaging materials from the unit.
3. Connect the power adaptor to the DC input jack on the rear panel.
NOTE: It is strongly recommended that this product should be operated only from the type of power source indicated on the marking label.
4. Select the corresponding **SIZE** and **SPEED** before playing the record.
5. Use the **45 RPM ADAPTOR** on the rear panel (under the Record fixator) to fit the **45 RPM record**.
Please refer to install page for more installation details.

REPLACE THE STYLUS (#AT3600L)

The stylus should last about 300 hours under normal use. It is recommended that the stylus be replaced as soon as you notice a change in sound quality.

REMOVE THE STYLUS FROM THE CARTRIDGE

1. Place your fingers at the tip of the stylus and push down to "A".
2. Pull the stylus out toward the direction "B".

NOTE: When applying force to the stylus, too much may damage or break the cartridge.

INSTALL THE STYLUS

1. Hold the tip of the stylus and insert the other edge by pressing toward the direction "C".
2. Push the stylus up toward the direction "D" until it locks at the tip.

CAUTION:

1. Do not remove or bend the stylus needle.
2.  Sharp edges, do not touch the needle to avoid injury to your hand.
3. Turn off the power before you replace the stylus.
4. Keep out of reach of children.

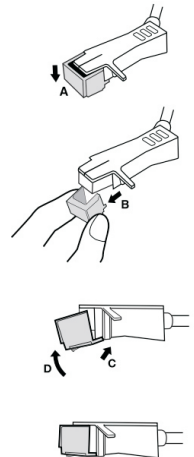

BASIC OPERATION

BUTTON OPERATION

POWER ON

1. Connect the power adaptor into the **DC INPUT JACK** on the rear panel.
2. Press and hold the **POWER/MODE KNOB** on the front panel to power on the unit.

SELECT MODE

Slightly press the **POWER/MODE KNOB** to select the play mode: **VINYL** mode, **VINYL STREAM** mode, **BLUETOOTH** mode.

VOLUME CONTROL

1. Rotate the **VOLUME KNOB** to adjust the volume.
2. For private listening, first reduce the volume level to the minimum.
Insert the earphones' plug into the **EARPHONE JACK** on the rear panel, then adjust the volume up by the volume knob.

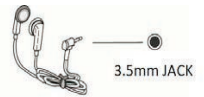

NOTE: Avoid listening by the earphone for long time, or it can damage the hearing.

LISTENING TO THE VINYL RECORD

1. Press the **POWER/MODE KNOB** to enter the **VINYL MODE**.
2. Remove the **RECORD FIXATOR** on the back of turntable by pressing the plastic tabs together and pulling the **FIXATOR** out.
3. Gently put the **Vinyl record** on the turntable, then put the **RECORD FIXATOR** on the record until you hear a click sound.
4. Select the record **size** and record **speed**.
5. Press the **START** button to start playing the record.
NOTE: The tone arm will automatically move to the edge of the record, and the turntable will begin to turn.
6. Press the **STOP** button to stop playing the record.
NOTE: The tone arm will automatically move back to the **tone arm holder**, and the turntable will stop turning.
7. Press the **UP/DOWN** button to lift or lay down the tone arm temporary.

BASIC OPERATION

VINYL STREAM (BLUETOOTH OUTPUT MODE)

1. While playing the Vinyl record on VINYL mode, press the **POWER/MODE KNOB** to enter the **VINYL STREAM** mode. The indicator light flashes **white**.
2. Turn on your external Bluetooth device's Bluetooth setting on.
3. Wait for a few seconds, the Vinyl unit will automatically pairs the external Bluetooth device.
4. The Vinyl unit will play the music automatically via external Bluetooth device.

BLUETOOTH MODE

1. Press the **POWER/MODE KNOB** to enter the Bluetooth mode.
2. When the indicator light flashes **blue**, it is in Bluetooth pairing mode.
3. Turn on the Bluetooth function on the phone, then enter the Bluetooth search page, and search for the pairing name "**YY1638**".
4. Input the password "0000" if required.
5. When they pair successfully, the indicator light stop flashing.
6. Place the Bluetooth devices within 10 meters.
7. The playback operation is controlled by your external device.

AUDIO OUT MODE

1. While playing Vinyl record, use the **RIGHT/LEFT AUDIO CABLE** to connect the audio output jack on the rear panel of Vinyl unit with other amplifier device with RCA auxiliary sockets.
2. The playback operation is controlled by the Vinyl unit.

TROUBLE SHOOTING

TROUBLE SHOOTING		
SYMPTOM	POSSIBLE CAUSE	SOLUTION
Can not power on.	Unit is unplugged.	Connect the DC power adaptor to the jack.
No sound output from speakers.	Volume is set too low. The input selector does not match the playback source.	Adjust the volume. Select the correct input source.
Noise / distortion in sound output.	The unit is too close to a TV set or other interfering device.	Turn off the TV or other appliance, and relocate the unit.
Fails to respond.	It might result from external factors such as ESD (Electrostatic discharge).	Disconnect the power cord and external audio device. Re-plug the power cord after one minute.
PHONO		
Unable to pair with a Bluetooth device.	The turntable stylus is worn out.	Replace the stylus.
BLUETOOTH		
No sound.	The unit is not switched to the Bluetooth mode. Your device's and/or unit's volumes is not turn up. Your device is toot far from the unit or there're some obstacle between your device and your unit.	Ensure the unit is switched toBT mode. Move your BT device closer to the unit. Turn up the volume on your paired device and/ or the unit. Turn off your BT device and unit, then power on.
Unable to pair with a Bluetooth device.	Unable to pair with a Bluetooth device.	Confirm the device is BT compatible and repair.



SPECIFICATIONS

PRODUCT SPECIFICATIONS

Power supply	DC 9V, 1.5A
Power consumption	13.5W
Power output	2x5W
Bluetooth version	Bluetooth V5.3
Operating distance	10 meters (33 feet)

POWER ADAPTOR

1. To disconnect the unit from the mains supply, unplug the lead from the mains socket.
2. Only use the supplied mains adaptor as failure to do this may result in a safety risk and/or damage to the unit.

-  AC voltage
-  DC voltage
-  Class II equipment

In order to prevent fire, always keep candles and open flames away from this product.



This symbol appears on electrical and electronic equipment (or packaging) to remind users of this. Users are requested to use existing return facilities for used equipment and batteries.



Trademarks:

The Bluetooth® word mark and logos are registered trademarks owned by Bluetooth SIG, Inc.



IMPORTANT INFORMATION

FCC/IC STATEMENTS

This device complies with Part 15 of the FCC Rules. Operation is subject to the following two conditions:

- (1) This device may not cause harmful interference, and
- (2) this device must accept any interference received, including interference that may cause undesired operation.

NOTE:

This equipment has been tested and found to comply with the limits for a Class B digital device, pursuant to Part 15 of the FCC Rules. These limits are designed to provide reasonable protection against harmful interference in a residential installation. This equipment generates uses and can radiate radio frequency energy and, if not installed and used in accordance with the instructions, may cause harmful interference to radio communications.

However, there is no guarantee that interference will not occur in a particular installation. If this equipment does cause harmful interference to radio or television reception, which can be determined by turning the equipment off and on, the user is encouraged to try to correct the interference by one of the following measures:

- Reorient or relocate the receiving antenna.
- Increase the separation between the equipment and receiver.
- Connect the equipment into an outlet on a circuit different from that to which the receiver is connected.
- Consult the dealer or an experienced radio/TV technician for help.

WARNING:

- Any changes or modifications not expressly approved by the party responsible for compliance could void the user's authority to operate this equipment.

FCC & IC RADIATION EXPOSURE STATEMENT:

This equipment complies with FCC and Canada radiation exposure limits set forth for an uncontrolled environment. This equipment should be installed and operated with a minimum distance of 20cm between the radiator and your body. This transmitter must not be co-located or operating in conjunction with any other antenna or transmitter.

IMPORTANT INFORMATION

FCC/IC STATEMENTS

CAN ICES(B)/NMB-3(B)

This device contains licence-exempt transmitter(s)/receiver(s) that comply with Innovation, Science and Economic Development Canada's licence-exempt RSS(s). Operation is subject to the following two conditions:

- (1) This device may not cause interference.
- (2) This device must accept any interference, including interference that may cause undesired operation of the device.

L'émetteur/récepteur exempt de licence contenu dans le présent appareil est conforme aux CNR d'Innovation, Sciences et Développement économique Canada applicables aux appareils radio exempts de licence. L'exploitation est autorisée aux deux conditions suivantes :

- (1) L'appareil ne doit pas produire de brouillage;
- (2) L'appareil doit accepter tout brouillage radioélectrique subi, même si le brouillage est susceptible d'en compromettre le fonctionnement.